

# Q85 Sensors

Compact Photoelectric Sensors with Universal Voltage and Wiring Chamber

## Features



- Economical photoelectric sensors in NEMA-6P (IEC IP67) ABS housing
- Signal (AID™ System) and Output indicator LEDs
- Wiring chamber with two conduit entrances
- Available in three electrical configurations:

**Q85VR3 Models:** 24 to 240V ac or 12 to 240V dc supply voltage, 3 amp electromechanical output relay

**Q85BW13 Models:** 24 to 240V ac or 12 to 240V dc supply voltage, SPST 0.3 amp isolated solid-state output switch, light/dark operate switch

**Q85BB62 Models:** 10 to 48V dc supply voltage, bipolar solid-state outputs (one NPN sinking and one PNP sourcing), low-saturation hookup option for TTL compatibility, light/dark operate switch

- “T9” model suffix indicates selectable output timing (8 options, configured via DIP switch; see page 3)

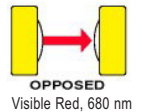

## Opposed Mode Emitter (E) and Receiver (R) Models

Models	Range	Supply Voltage	Output Type	Output Timing	Excess Gain	Beam Pattern	
Q853E	23 m (75')	12 – 240V dc 24 – 240V ac	—	—			
Q85VR3R				No			Effective Beam: 9.6 mm
Q85VR3R-T9			SPDT E/m Relay	Yes			
Q85BW13R			SPST Solid-state Switch	No			
Q85BW13R-T9		SPST Solid-state Switch	Yes				
Q8562E		10 – 48V dc	—	—			—
Q85BB62R				Bipolar NPN/PNP			No
Q85BB62R-T9			Bipolar NPN/PNP	—			—
	—			Yes			

See page 2 for more models



### WARNING . . . Not To Be Used for Personnel Protection

Never use these products as sensing devices for personnel protection. Doing so could lead to serious injury or death.

These sensors do NOT include the self-checking redundant circuitry necessary to allow their use in personnel safety applications. A sensor failure or malfunction can cause either an energized or de-energized sensor output condition. Consult your current Banner Safety Products catalog for safety products which meet OSHA, ANSI and IEC standards for personnel protection.



# Q85 Sensors



## Polarized Retroreflective Mode Models

Models	Range*	Supply Voltage	Output Type	Output Timing	Excess Gain	Beam Pattern
Q85VR3LP	80 mm – 4.6 m (3" – 15')	12 – 240V dc 24 – 240V ac	SPDT E/m Relay	No		
Q85VR3LP-T9				Yes		
Q85BW13LP			SPST Solid-state Switch	No		
Q85BW13LP-T9				Yes		
Q85BB62LP		10 – 48V dc	Bipolar NPN/PNP	No		
Q85BB62LP-T9				Yes		

\*NOTE: Retroreflective range is specified using one model BRT-3 retroreflector (3" diameter). Actual sensing range may be more or less than specified, depending upon the efficiency and reflective area of the retroreflector(s) used.

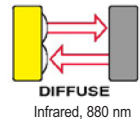

## Diffuse Mode Models

Models	Range	Supply Voltage	Output Type	Output Timing	Excess Gain	Beam Pattern
Performance based on 90% reflectance white test card						
<b>Short Range</b>						
Q85VR3D	250 mm (10")	12 – 240V dc 24 – 240V ac	SPDT E/m Relay	No		
Q85VR3D-T9				Yes		
Q85BW13D			SPST Solid-state Switch	No		
Q85BW13D-T9				Yes		
Q85BB62D		10 – 48V dc	Bipolar NPN/PNP	No		
Q85BB62D-T9				Yes		
<b>Long Range</b>						
Q85VR3DL	1 m (40")	12 – 240V dc 24 – 240V ac	SPDT E/m Relay	No		
Q85VR3DL-T9				Yes		
Q85BW13DL			SPST Solid-state Switch	No		
Q85BW13DL-T9				Yes		
Q85BB62DL		10 – 48V dc	Bipolar NPN/PNP	No		
Q85BB62DL-T9				Yes		

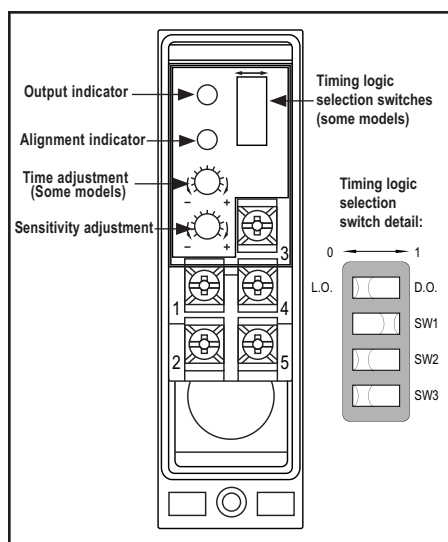

Figure 1. Features; wiring chamber shown with sensor cover removed

## Overview

Most adjustments are made to the sensor via switches accessible under the sensor's gasketed cover. For **Q85VR3..** models, the light/dark operate selection is made via the hookup. For other models, the selection is made via a switch (see Figure 1).

**Light operate (L.O.):** the sensor's outputs are energized when the sensor sees its own modulated light source (after any ON-delay). **Dark operate (D.O.):** the outputs are energized when the sensor does not see its modulated light source (after any ON-delay).

Sensor sensitivity is set at the single-turn Sensitivity Adjustment potentiometer.

### Timing Logic Selection (T9 Models)

The output timing logic function (on sensor models with "T9" model number suffix) is selected at the Timing Logic selection switches, according to the table below. The output timing logic delays are set at the single-turn Time Adjustment potentiometer. When the timing function involves more than one time (as in ON- and OFF-delay, ON-delayed one-shot, and ON-delayed limit timer functions), the potentiometer sets both times to the same value, between 0.1 and 5 seconds.

Logic Function	Switch		
	SW1	SW2	SW3
Both ON- and OFF-delays	0	0	0
ON-delay only	0	0	1
OFF-delay only	0	1	0
No delay	0	1	1
ON-delayed one-shot	1	0	0
ON-delayed limit timer	1	0	1
One-shot	1	1	0
Limit timer	1	1	1

# Q85 Sensors

## Q85VR3 Model Specifications

<b>Supply Voltage and Current</b>	24 to 240V ac, 50/60 Hz or 12 to 240V dc (2 watts maximum)
<b>Supply Protection Circuitry</b>	Protected against transient voltages. DC hookup is without regard to polarity.
<b>Output Configuration</b>	<b>Q85VR3..</b> models - SPDT e/m relay, ON/OFF output <b>Q85VR3..-T9</b> models - SPDT e/m relay, selectable timer
<b>Output Rating</b>	<b>Maximum switching power (resistive load):</b> 90W, 750 VA <b>Maximum switching voltage (resistive load):</b> 250V ac or 30V dc <b>Maximum switching current (resistive load):</b> 3A <b>Minimum voltage and current:</b> 5V dc, 10 mA <b>Mechanical life:</b> 50,000,000 operations <b>Electrical life at full resistive load:</b> 100,000 operations
<b>Output Protection Circuitry</b>	Protected against false pulse on power up.
<b>Output Response Time</b>	<b>Closure time (no time logic in use):</b> 20 milliseconds max. <b>Release time (no time logic in use):</b> 20 milliseconds max. <b>Maximum switching speed:</b> 25 operations per second
<b>Repeatability</b>	<b>All sensing modes (no time logic in use):</b> 1 millisecond
<b>Adjustments</b>	Single-turn Sensitivity control potentiometer, accessible beneath the ABS wiring chamber cover. Timing logic (for "T9" models) is configured via DIP switch. Pulse length and delay are set by a single-turn potentiometer (under the wiring chamber cover). The adjustable time range for both functions is 0.1 to 5 seconds; both functions are automatically set to the same value.
<b>Indicators</b>	Exclusive Alignment Indicating Device system (AID™) lights a red LED indicator whenever the sensor sees its own modulated light, and pulses at a rate proportional to the strength of the light signal. Yellow indicator lights whenever the sensor's output is energized.
<b>Construction</b>	Yellow ABS housing, acrylic lenses, and steel-plated hardware. Maximum wire size (for connection to wiring terminals) is #14 AWG.
<b>Environmental Rating</b>	Meets NEMA standards 1, 2, 3, 3S, 4, 4X, 6, 6P, 12, and 13; IEC IP67
<b>Operating Conditions</b>	<b>Temperature:</b> -25° to +55°C (-13° to +131°F) <b>Max. Relative Humidity:</b> 90% at 50°C (non-condensing)
<b>Vibration and Mechanical Shock</b>	Meets Mil. Std. 202F requirements. Method 201A (Vibration: frequency 10 to 55 Hz max., double-amplitude 0.06", max. acceleration 10G) Method 213B conditions H & I (Shock: 75G with unit operating; 100G for non-operation)
<b>Application Notes</b>	Install transient suppressor (MOV) across contacts switching inductive loads.
<b>Certifications</b>	

## Q85VR3 Model Hookups

Q853E Emitter

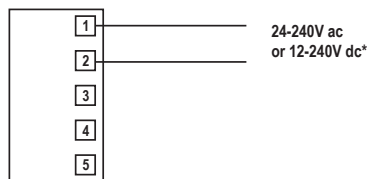

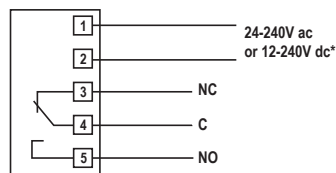

\*NOTE: Connection of dc power is without regard to polarity

Other Q85VR3 Models



\*NOTE: Connection of dc power is without regard to polarity

## Q85BW13 Model Specifications

<b>Supply Voltage and Current</b>	24 to 240V ac, 50/60 Hz or 12 to 240V dc (2 watts maximum)				
<b>Supply Protection Circuitry</b>	Protected against transient voltages. DC hookup is without regard to polarity.				
<b>Output Configuration</b>	<b>Q85BW13.. models:</b> optically isolated SPST solid-state switch, ON/OFF output <b>Q85BW13..-T9 models:</b> optically isolated SPST solid-state switch, selectable timer				
<b>Output Rating</b>	250V ac, 250V dc, 300 mA <b>Output saturation voltage:</b> 3V at 300 mA, 2V at 15 mA <b>Off-state leakage current:</b> <50 microamps <b>Inrush current:</b> 1 amp for 20 milliseconds, non-repetitive				
<b>Output Protection Circuitry</b>	Protected against false pulse on power up				
<b>Output Response Time and Repeatability</b>	Response time and repeatability are independent of signal strength:				
	<b>Model</b>	<b>Response Time</b>	<b>Repeatability</b>	<b>Model*</b>	<b>Response Time</b>
	<b>Q85BW13R</b>	6 ms ON/ 3 ms OFF	750 $\mu$ s	<b>Q85BW13R-T9</b>	12 ms ON/ 9 ms OFF
	<b>Q85BW13LP</b>	4 ms ON/OFF	1 ms	<b>Q85BW13LP-T9</b>	10 ms ON/OFF
	<b>Q85BW13D</b>	4 ms ON/OFF	1 ms	<b>Q85BW13D-T9</b>	10 ms ON/OFF
	<b>Q85BW13DL</b>	4 ms ON/OFF	1 ms	<b>Q85BW13DL-T9</b>	10 ms ON/OFF
	*ON/OFF operation (no timing in use)				
<b>Adjustments</b>	Single-turn Sensitivity control potentiometer, accessible beneath the ABS wiring chamber cover. Timing logic (for "T9" models) is configured via DIP switch. Pulse length and delay are set by a single-turn potentiometer (under the wiring chamber cover). The adjustable time range for both functions is 0.1 to 5 seconds; both functions are automatically set to the same value. All models have a light/dark operate switch under the wiring chamber cover.				
<b>Indicators</b>	Exclusive Alignment Indicating Device system (AID™) lights a red LED indicator whenever the sensor sees its own modulated light, and pulses at a rate proportional to the strength of the light signal. Yellow indicator lights whenever the sensor's output is conducting.				
<b>Construction</b>	Yellow ABS housing, acrylic lenses, and steel-plated hardware. Maximum wire size (for connection to wiring terminals) is #14 AWG.				
<b>Environmental Rating</b>	Meets NEMA standards 1, 2, 3, 3S, 4, 4X, 6, 6P, 12, and 13; IEC IP67				
<b>Operating Conditions</b>	<b>Temperature:</b> -25° to +55°C (-13° to +131°F) <b>Max. Relative Humidity:</b> 90% at 50°C (non-condensing)				
<b>Vibration and Mechanical Shock</b>	Meets Mil. Std. 202F requirements. Method 201A (Vibration: frequency 10 to 55 Hz max., double-amplitude 0.06", max. acceleration 10G) Method 213B conditions H & I (Shock: 75G with unit operating; 100G for non-operation)				
<b>Certifications</b>	 				

## Q85BW13 Model Hookups

**Q853E Emitter**

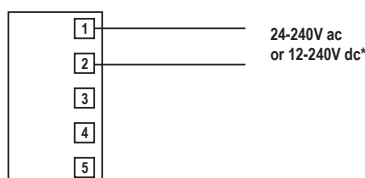

\*NOTE: Connection of dc power is without regard to polarity

**Other Q85BW13 Models**

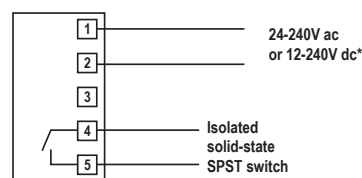

\*NOTE: Connection of dc power is without regard to polarity

# Q85 Sensors

## Q85BB62 Model Specifications

<b>Supply Voltage and Current</b>	10 to 48V dc at 50 mA max. exclusive of load; <b>Q8562E</b> emitter requires 25 mA																														
<b>Supply Protection Circuitry</b>	Protected against reverse-polarity																														
<b>Output Configuration</b>	<b>Q85BB62.. models:</b> NPN sinking and PNP sourcing outputs, ON/OFF output <b>Q85BB62..-T9 models:</b> NPN sinking and PNP sourcing outputs, selectable timer																														
<b>Output Rating</b>	<b>Standard outputs</b> are solid-state, one NPN, one PNP; 150 mA max. (at 25°C, either output). Derate output by 1 mA/°C above 25°C <b>Off-state leakage current:</b> <1 µA <b>Output saturation voltage:</b> <1V at 10 mA and <2V at 150 mA The two standard outputs may be used simultaneously (max. load 150 mA each output)  <b>Low-saturation voltage alternative NPN output</b> is provided for easy interfacing to TTL and similar circuitry <b>Output saturation voltage:</b> <200 millivolts at 10 mA and <1V at 150 mA Overload and short circuit protected This output is not reverse-polarity protected																														
<b>Output Protection Circuitry</b>	Protected against false pulse on power-up, overload and short circuit of outputs																														
<b>Output Response Time and Repeatability</b>	Response time and repeatability are independent of signal strength: <table border="1" style="width: 100%; border-collapse: collapse;"> <thead> <tr> <th>Model</th> <th>Response Time</th> <th>Repeatability</th> <th>Model*</th> <th>Response Time</th> <th>Repeatability</th> </tr> </thead> <tbody> <tr> <td>Q85BB62R</td> <td>1 ms</td> <td>125 µs</td> <td>Q85BB62R-T9</td> <td>8 ms</td> <td>1 ms</td> </tr> <tr> <td>Q85BB62LP</td> <td>1 ms</td> <td>250 µs</td> <td>Q85BB62LP-T9</td> <td>8 ms</td> <td>1 ms</td> </tr> <tr> <td>Q85BB62D</td> <td>1 ms</td> <td>250 µs</td> <td>Q85BB62D-T9</td> <td>8 ms</td> <td>1 ms</td> </tr> <tr> <td>Q85BB62DL</td> <td>2 ms</td> <td>500 µs</td> <td>Q85BB62DL-T9</td> <td>8 ms</td> <td>1 ms</td> </tr> </tbody> </table> <p>*ON/OFF operation (no timing in use)</p>	Model	Response Time	Repeatability	Model*	Response Time	Repeatability	Q85BB62R	1 ms	125 µs	Q85BB62R-T9	8 ms	1 ms	Q85BB62LP	1 ms	250 µs	Q85BB62LP-T9	8 ms	1 ms	Q85BB62D	1 ms	250 µs	Q85BB62D-T9	8 ms	1 ms	Q85BB62DL	2 ms	500 µs	Q85BB62DL-T9	8 ms	1 ms
Model	Response Time	Repeatability	Model*	Response Time	Repeatability																										
Q85BB62R	1 ms	125 µs	Q85BB62R-T9	8 ms	1 ms																										
Q85BB62LP	1 ms	250 µs	Q85BB62LP-T9	8 ms	1 ms																										
Q85BB62D	1 ms	250 µs	Q85BB62D-T9	8 ms	1 ms																										
Q85BB62DL	2 ms	500 µs	Q85BB62DL-T9	8 ms	1 ms																										
<b>Adjustments</b>	Single-turn Sensitivity control potentiometer, accessible beneath the ABS wiring chamber cover. Timing logic (for "T9" models) is configured via DIP switch. Pulse length and delay are set via single-turn potentiometer (under the wiring chamber cover). The adjustable time range for both functions is 0.1 to 5 seconds; both functions are automatically set to the same value. All models have a light/dark operate switch under the wiring chamber cover.																														
<b>Indicators</b>	Exclusive Alignment Indicating Device system (AID™) lights a red LED indicator whenever the sensor sees its own modulated light, and pulses at a rate proportional to the strength of the light signal. Yellow indicator lights whenever the sensor's output is energized.																														
<b>Construction</b>	Yellow ABS housing, acrylic lenses, and steel-plated hardware. Maximum wire size (for connection to wiring terminals) is #14 AWG.																														
<b>Environmental Rating</b>	Meets NEMA standards 1, 2, 3, 3S, 4, 4X, 6, 6P, 12, and 13; IEC IP67																														
<b>Operating Conditions</b>	<b>Temperature:</b> -25° to +55°C (-13° to +131°F) <b>Max. Relative Humidity:</b> 90% at 50°C (non-condensing)																														
<b>Vibration and Mechanical Shock</b>	Meets Mil. Std. 202F requirements. Method 201A (Vibration: frequency 10 to 55 Hz max., double-amplitude 0.06", max. acceleration 10G) Method 213B conditions H & I (Shock: 75G with unit operating; 100G for non-operation)																														
<b>Certifications</b>																															

## Q85BB62 Model Hookups

**Q8562E Emitter**

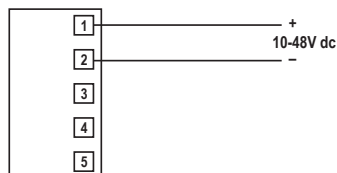

**Q85BB62 Standard**

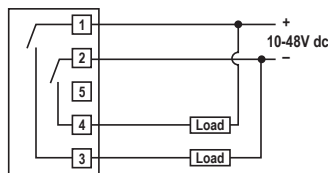

**Alternative Low Saturation Sinking (NPN) Hookup**

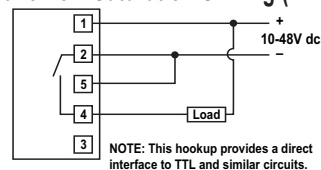

NOTE: This hookup provides a direct interface to TTL and similar circuits.

CAUTION: The output is NOT reverse-polarity protected in this wiring configuration.

## Dimensions

### Q85 Sensor

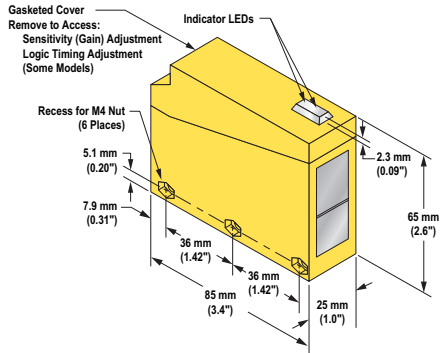

### Bottom View

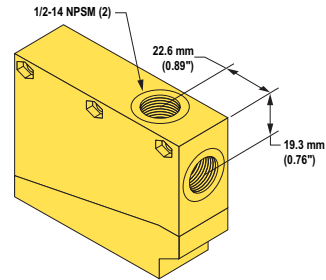

## Mounting Brackets

### SMB85B

- Bottom-mount bracket
- Supplied with sensor

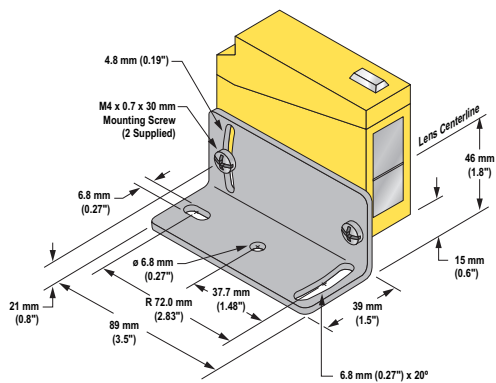

### SMB85R

- Rear-mount bracket
- Accessory, sold separately

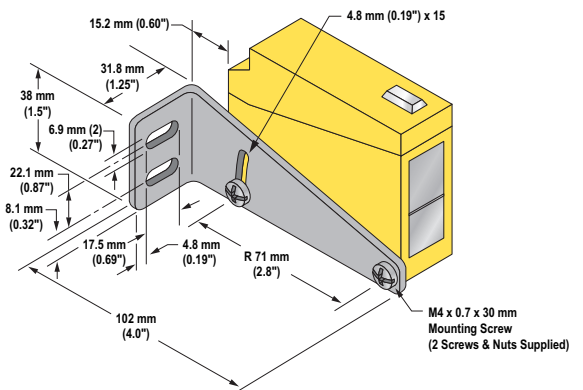

# Q85 Sensors

## Quick-Disconnect (QD) Receptacles and Cordsets

NOTE: The QD receptacles listed below in effect convert a Q85 sensor to a QD model. A coordinating QD cordset is required for use with a QD receptacle.

Style	For use with:	Receptacle		Cordset		
		Model	Cable Length	Model	Length	Connector
3-Pin Mini-style Receptacle and Cordset	Q85 emitters	<b>MBC-3</b>	300 mm (12")	<b>MBCC-306</b> <b>MBCC-312</b> <b>MBCC-330</b>	2 m (6.5') 4 m (12') 9 m (30')	Straight
4-Pin Mini-style Receptacle and Cordset	All Q85 sensors, 4-wire hookup	<b>MBC-4</b>	300 mm (12")	<b>MBCC-406</b> <b>MBCC-412</b> <b>MBCC-430</b>	2 m (6.5') 4 m (12') 9 m (30')	
5-Pin Mini-style Receptacle and Cordset	All Q85 sensors, 5-wire hookup	<b>MBC-5</b>	300 mm (12")	<b>MBCC-506</b> <b>MBCC-512</b> <b>MBCC-530</b>	2 m (6.5') 4 m (12') 9 m (30')	



P/N 137791

**WARRANTY:** Banner Engineering Corp. warrants its products to be free from defects for one year. Banner Engineering Corp. will repair or replace, free of charge, any product of its manufacture found to be defective at the time it is returned to the factory during the warranty period. This warranty does not cover damage or liability for the improper application of Banner products. This warranty is in lieu of any other warranty either expressed or implied.