

Accessories

Retroreflective Targets	722
Retroreflective Tape	731
Cables	732
Brackets	740
BEAM TRACKER™	755
LAT-1 Laser Alignment Tool	756
DBQ5 Demo Box	757
SPS100 Sensor Power Supply	758

Retroreflectors

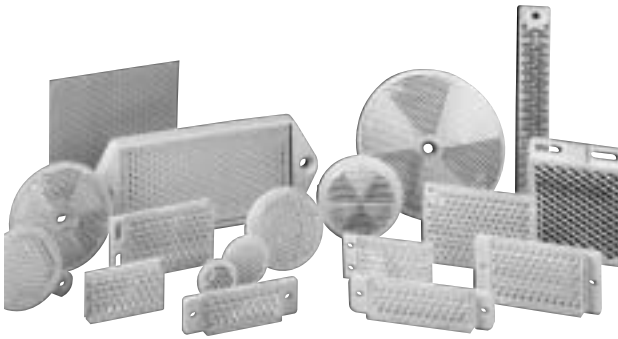

- High-quality acrylic targets, high-temperature targets, and adhesive-backed retro tapes
- Comprehensive selection of sizes, shapes and mounting options
- Banner also offers several "micro-prism" reflectors, for use with laser retroreflective sensors and Banner VS3 models.

NOTE: Sensing range and signal strength at any given sensor-to-target distance will vary due to target reflectivity and target area. A "Reflectivity Factor" is included for each target model to help predict sensor performance, relative to the excess gain curve plotted for target model BRT-3. Consider, also, target area when predicting performance. Changing to a high reflectivity reflector (like BRT-92x92C) may also extend sensor range and/or reduce the need for frequent reflector maintenance.

Retroreflective Targets			
Model	Reflectivity Factor	Maximum Temperature	Dimensions
BRT-3*	1.0	65°C (150°F)	
BRT-84*	1.4	65°C (150°F)	
BRT-2A	1.0	65°C (150°F)	

* Optional brackets are available. See Brackets on pages 740 and 741.

Retroreflective Targets			
Model	Reflectivity Factor	Maximum Temperature	Dimensions
BRT-50	1.0	65°C (150°F)	
BRT-1.5	1.0	65°C (150°F)	
BRT-1	1.0	65°C (150°F)	
BRT-.6	1.0	65°C (150°F)	
BRT-50D*	1.0	65°C (150°F)	

* Optional brackets are available. See Brackets on pages 740 and 741.

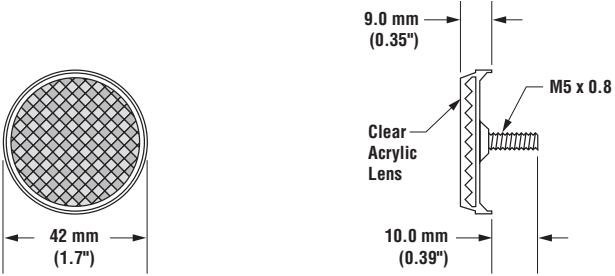
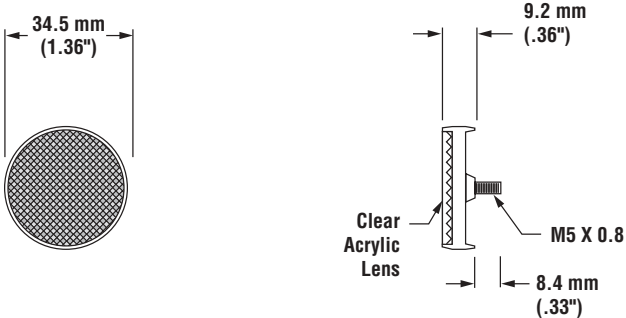
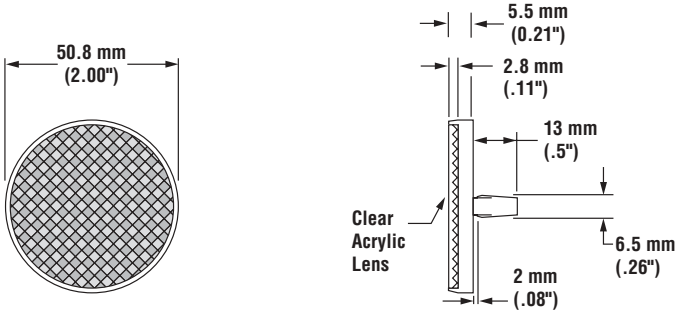
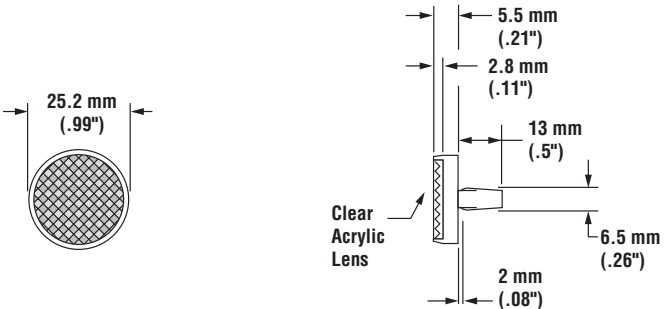
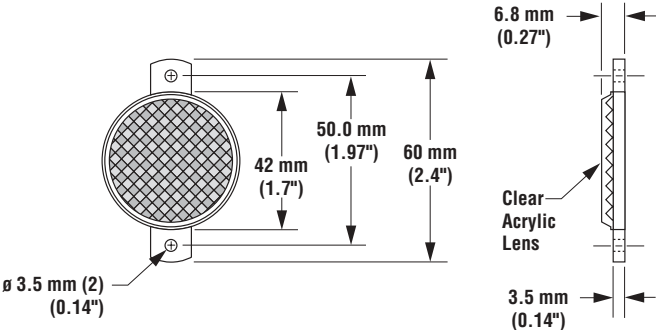
Retroreflective Targets			
Model	Reflectivity Factor	Maximum Temperature	Dimensions
BRT-42D	1.0	50°C (120°F)	
BRT-35DM	1.2	50°C (120°F)	<p>NOTE: This target has micro-prism geometry</p> 
BRT-50R*	1.0	50°C (120°F)	
BRT-25R	1.0	50°C (120°F)	
BRT-42A	1.0	50°C (120°F)	

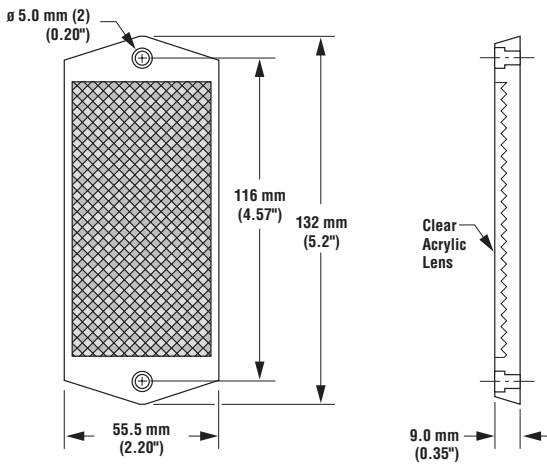
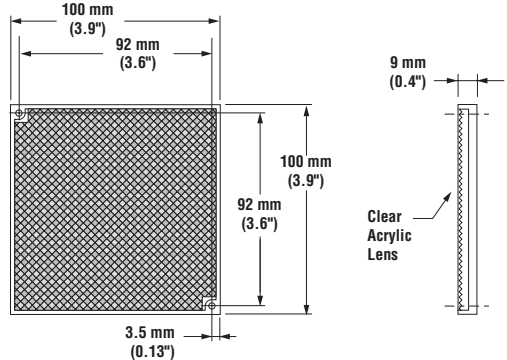
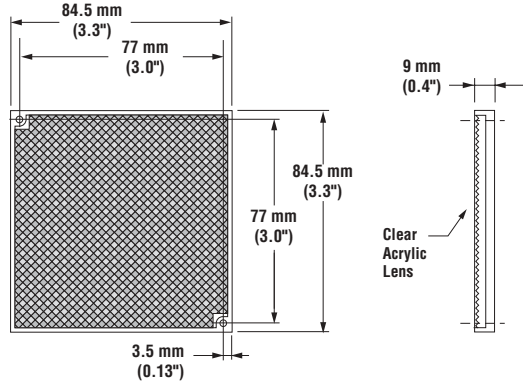
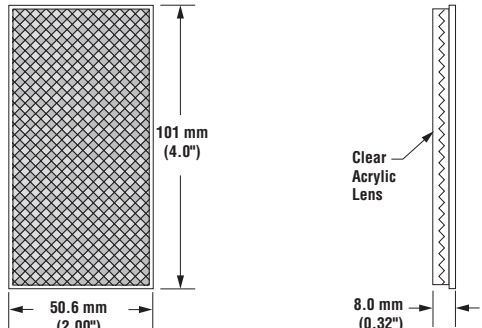
Retroreflective Targets			
Model	Reflectivity Factor	Maximum Temperature	Dimensions
BRT-100X55A	1.5	50°C (120°F)	
BRT-92X92C*	3.0	50°C (120°F)	
BRT-77X77C*	2.0	50°C (120°F)	
BRT-100X50	1.5	50°C (120°F)	

* Optional brackets are available. See Brackets on pages 740 and 741.

Retroreflective Targets			
Model	Reflectivity Factor	Maximum Temperature	Dimensions
BRT-80X50C	1.4	65°C (150°F)	
BRT-2X2*	1.0	50°C (120°F)	
BRT-36X40BM	1.2	50°C (120°F)	<p>NOTE: This target has micro-prism geometry</p>
BRT-60X40C*	1.4	50°C (120°F)	
BRT-48X32	1.0	50°C (120°F)	

* Optional brackets are available. See Brackets on pages 740 and 741.

Retroreflective Targets			
Model	Reflectivity Factor	Maximum Temperature	Dimensions
BRT-48X32A	1.0	50°C (120°F)	
BRT-48X32B	1.0	50°C (120°F)	
BRT-23X14CM	1.2	65°C (150°F)	<p>NOTE: This target has micro-prism geometry</p>
BRT-40X23	1.4	50°C (120°F)	
BRT-40X23B	1.4	50°C (120°F)	

Retroreflective Targets

Model	Reflectivity Factor	Maximum Temperature	Dimensions
<p>BRT-32X20AM</p> <p>NOTE: This target has micro-prism geometry</p>	1.2	65°C (150°F)	
<p>BRT-35X20A</p>	1.4	50°C (120°F)	
<p>BRT-40X18A</p>	1.0	50°C (120°F)	
<p>BRT-40X19A</p>	1.3	50°C (120°F)	
<p>BRT-40X19AM</p> <p>NOTE: This target has micro-prism geometry</p>	1.2	50°C (120°F)	

Retroreflective Targets			
Model	Reflectivity Factor	Maximum Temperature	Dimensions
<p>BRT-40X20AM</p> <p>NOTE: This target has micro-prism geometry</p>	1.2	50°C (120°F)	
<p>BRT-40X23A</p>	1.4	50°C (120°F)	
<p>BRT-62X10AM</p> <p>NOTE: This target has micro-prism geometry</p>	1.2	65°C (150°F)	
<p>BRT-53X19A</p>	1.4	50°C (120°F)	

†These targets are not recommended for polarized retroreflective sensors

Retroreflective Targets			
Model	Reflectivity Factor	Maximum Temperature	Dimensions
BRT-100X18A	1.4	50°C (120°F)	
BRT-L	0.8	65°C (150°F)	
BRT-41AHT	1.0	200°C (390°F)	
BRT-4HT†	0.15	480°C (900°F)	

† These targets are not recommended for polarized retroreflective sensors.

Retroreflective Tape					
Note: for maximum adhesion of all tape products, surfaces must be clean.					
Model	Reflectivity Factor	Maximum Temperature	Size	Unit	
BRT-THG-3X3-10	0.7	60°C (140°F)	75 x 75 mm (3 x 3")	Package of 10	
BRT-THG-4X4-5	0.7	60°C (140°F)	100 x 100 mm (4 x 4")	Package of 5	
BRT-THG-8.5X11-2	0.7	60°C (140°F)	216 x 280 mm (8.5 x 11")	Package of 2	
BRT-THG-18X36	0.7	60°C (140°F)	457 x 914 mm (18 x 36")	Single Sheet	
BRT-THG-1-100	0.7	60°C (140°F)	25 mm (1") wide	2.5 m (100") length	
BRT-THG-2-100	0.7	60°C (140°F)	50 mm (2") wide	2.5 m (100") length	
BRT-THG-3-100	0.7	60°C (140°F)	75 mm (3") wide	2.5 m (100") length	
BRT-T-100†	0.2	65°C (150°F)	25 mm (1") wide	2.5 m (100") length	
BRT-THT-100†	0.07	175°C (350°F)	25 mm (1") wide	2.5 m (100") length	
BRT-TVHG2X2*	0.8	60°C (140°F)	50 x 50 mm (2 x 2")	Package of 4	

† These targets are not recommended for polarized retroreflective sensors.

* These are sealed micro-prism style pieces and may not be cut.

Suitable for use with Laser sensors, VS3 sensors and SME312LPC model sensors.

Not suggested for close range (less than 4") except with VS3 sensors.

Cables and Connectors

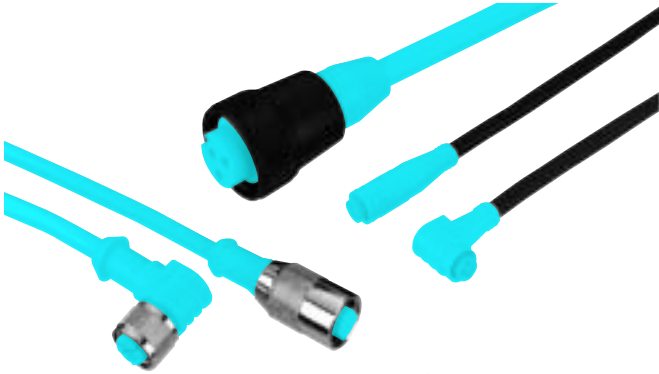

From bottom left to top right: Right-angle Micro-, Straight Micro-, Right-angle Pico-, Straight Pico- and Mini-style cables

Quick-disconnect (QD) cables allow sensors to be replaced or moved quickly, minimizing down-time

- Pico-, euro-, and mini-styles are available for dc-powered sensors
- Micro- and mini-styles are available for ac-powered sensors
- Choose straight or right-angle connectors
- Mini-style receptacles are available for creating quick-disconnect MULTI-BEAM, MAXI-BEAM and Q85 Series sensors
- Pico- and euro-style field-wireable connectors

Pico-Style Quick-Disconnect Cables

Cable: PUR jacket, polyurethane connector body, POM snap-lock coupling
Conductors: 26 or 24 AWG high-flex stranded, gold-plated contacts
Temperature: -40 to +90°C (-40 to +194°F)
Voltage Rating: 30V ac/36V dc

Style	Model	Length	Connection Type	Used with:	Dimensions	Pin-out
3-Pin Straight	PKG3-2	2 m (6.5')	Snap-on	<ul style="list-style-type: none"> • M12 Laser emitters • Q08 Diffuse Mode sensors • Q10 series • Q14 series 		
3-Pin Right-angle	PKW3-2	2 m (6.5')	Snap-on			
3-Pin Straight	PKG3M-2 PKG3M-9	2 m (6.5') 9 m (30')	Threaded	<ul style="list-style-type: none"> • VS1 series • VS2 series • VS3 series 		
3-Pin Right-angle	PKW3M-2 PKW3M-9	2 m (6.5') 9 m (30')	Threaded			
4-Pin Straight	PKG4-2	2 m (6.5')	Snap-on	<ul style="list-style-type: none"> • MINI-BEAM 2 • Q23 series • D11 series • D12 series • EZ-BEAM S12 series • PICO-AMP 		
4-Pin Right-angle	PKW4-2	2 m (6.5')	Snap-on			

Pico-Style Quick-Disconnect Cables (continued)						
Style	Model	Length	Connection Type	Used with:	Dimensions	Pin-out
6-Pin Straight	PKG6Z-2 PKG6Z-9	2 m (6.5') 9 m (30')	Snap-on	• D10 Series sensors		
6-Pin Right-angle	PKW6Z-2 PKW6Z-9	2 m (6.5') 9 m (30')	Snap-on			

Euro-Style Quick-Disconnect Cables

Cable: PVC jacket, polyurethane connector body, chrome-plated brass coupling nut
Conductors: 22 or 20 AWG high-flex stranded, PVC insulation, gold-plated contacts
Temperature: -40 to +90°C (-40 to +194°F)
Voltage Rating: 250V ac/300V dc



Style	Model	Length	Used with:	Dimensions	Pin-out
4-Pin Straight	MQD9-406 MQD9-415	2 m (6.5') 5 m (15')	<ul style="list-style-type: none"> MINI-BEAM and Q45 series NAMUR sensors 		
4-Pin Right-angle	MQD9-406RA MQD9-415RA	2 m (6.5') 5 m (15')			
4-Pin Straight	MQDC-406 MQDC-415 MQDC-430	2 m (6.5') 5 m (15') 9 m (30')	<ul style="list-style-type: none"> Standard OMNI-BEAM (QDH suffix) Q45 dc sensors (Q5 suffix) MINI-BEAM dc SM312 series EZ-BEAM dc (Q suffix except S12) SP12 series QM42 series PVA sensors 		
4-Pin Right-angle	MQDC-406RA MQDC-415RA MQDC-430RA	2 m (6.5') 5 m (15') 9 m (30')			
5-Pin Straight	MQDC1-506 MQDC1-515 MQDC1-530	2 m (6.5') 5 m (15') 9 m (30')	<ul style="list-style-type: none"> MINI-BEAM <i>Expert</i> PicoDot Q45 Laser Retro R55 R55F SL30, SL30E SL10, SL10E Q60 		
5-Pin Right-angle	MQDC1-506RA MQDC1-515RA MQDC1-530RA	2 m (6.5') 5 m (15') 9 m (30')			
6-Pin Straight	MQDC-606 MQDC-615 MQDC-630	2 m (6.5') 5 m (15') 9 m (30')	<ul style="list-style-type: none"> R55 <i>Expert</i> series 		
6-Pin Right-angle	MQDC-606RA MQDC-615RA MQDC-630RA	2 m (6.5') 5 m (15') 9 m (30')			

Micro-Style Quick-Disconnect Cables

Cable: PVC jacket, polyurethane connector body, chrome-plated brass coupling nut
Conductors: 22 or 20 AWG high-flex stranded, PVC insulation, gold-plated contacts
Temperature: -40 to +80°C (-40 to +176°F)
Voltage Rating: 250V ac/300V dc (3-pin), 125V ac/150V dc (4-pin)



Style	Model	Length	Used with:	Dimensions	Pin-out
3-Pin Straight	MQDC-306 MQDC-315 MQDC-330	2 m (6.5') 5 m (15') 9 m (30')	• MINI-BEAM ac SM2A312 series		
3-Pin Right-angle	MQDC-306RA MQDC-315RA MQDC-330RA	2 m (6.5') 5 m (15') 9 m (30')			
4-Pin Straight	MQAC-406 MQAC-415 MQAC-430	2 m (6.5') 5 m (15') 9 m (30')	• Q45 ac series (suffix Q1) • EZ-BEAM ac series (suffix Q1)		
4-Pin Right-angle	MQAC-406RA MQAC-415RA MQAC-430RA	2 m (6.5') 5 m (15') 9 m (30')			

Accessories – Cables and Connectors

Mini-Style Quick-Disconnect Cables

Cable: PVC jacket, polyurethane connector body, nylon coupling nut
Conductors: 18 AWG high-flex stranded, PVC insulation, gold plated contacts
Temperature: -40 to +80°C (-40 to +176°F)
Voltage Rating: 250V ac/300V dc

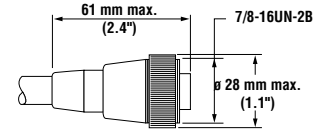

Style	Model	Length	Used with:	Pin-out
3-Pin Female Pin-out Straight	MBCC-306 MBCC-312 MBCC-330	2 m (6.5') 4 m (12') 9 m (30')	<ul style="list-style-type: none"> • Q45 3-wire ac (Q suffix) • VALU-BEAM 2-wire • VALU-BEAM emitters • VALU-BEAM 990 series 	
3-Pin Female Pin-out Straight	SM30CC-306 SM30CC-312	2 m (6.5') 4 m (12')	<ul style="list-style-type: none"> • SM30 2-wire ac 	
4-Pin Female Pin-out Straight	MBCC-406 MBCC-412 MBCC-430	2 m (6.5') 4 m (12') 9 m (30')	<ul style="list-style-type: none"> • Q45 dc (Q suffix) • OMNI-BEAM dc power blocks • VALU-BEAM 912 dc series • SM30 dc series • Optical Touch Button (OTB) w/solid-state output 	
5-Pin Female Pin-out Straight	MBCC-506 MBCC-512 MBCC-530	2 m (6.5') 4 m (12') 9 m (30')	<ul style="list-style-type: none"> • Q45 Laser Retro • OMNI-BEAM ac power blocks • OMNI-BEAM dc with e/m relay • VALU-BEAM 915 series • OTB & LTB w/SPDT relay • Q45 series 5-wire ac • Q45X series 	

Pico-Style Field-Wireable Connectors

Contacts: Gold-plated; rated 60V ac/dc max., 4 A max.
Cable Diameter: 4.0 to 5.0 mm (0.16 to 0.20")
Temperature: -25 to +70°C (-13 to +156°F)
Environmental Rating: NEMA 6P, IP 67

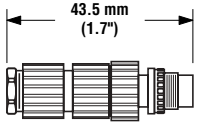
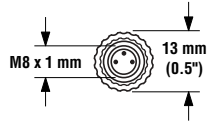
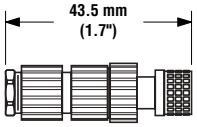
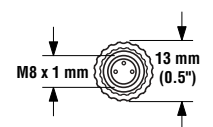
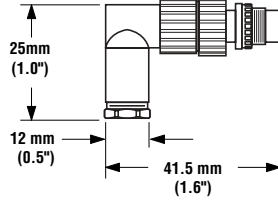
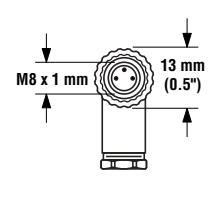
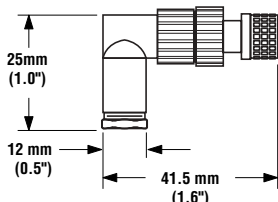
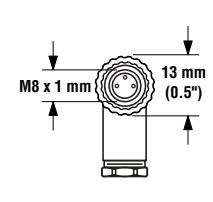
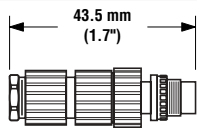
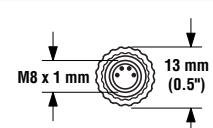
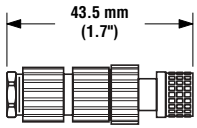
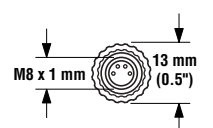
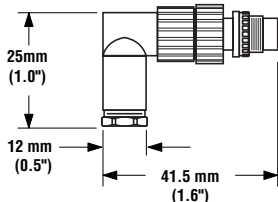
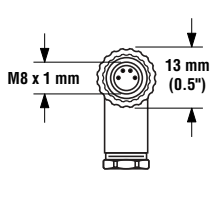
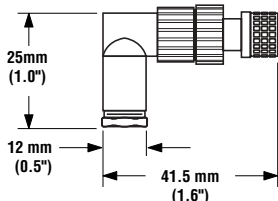
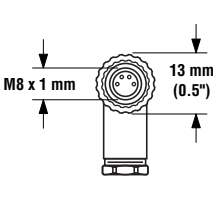
Style	Model	Gender	Dimensions	Pin-out
3-Pin Straight	FIC-M8M3	Male		
	FIC-M8F3	Female		
3-Pin Right-angle	FIC-M8M3A	Male		
	FIC-M8F3A	Female		
4-Pin Straight	FIC-M8M4	Male		
	FIC-M8F4	Female		
4-Pin Right-angle	FIC-M8M4A	Male		
	FIC-M8F4A	Female		

Euro-Style Field-Wireable Connectors

Contacts: Gold-plated; 4-pin models rated 250V ac/dc max., 4 A max.; 5-pin models rated 50V ac/dc max., 4A max.
Cable Diameter: 4.0 to 5.0 mm (0.16 to 0.20")
Temperature: -25 to +90°C (-13 to +194°F)
Environmental Rating: NEMA 6P, IP 67

Style	Model	Gender	Dimensions	Pin-out
4-Pin Straight	FIC-M12M4	Male		
	FIC-M12F4	Female		
4-Pin Right-angle	FIC-M12M4A	Male		
	FIC-M12F4A	Female		
5-Pin Straight	FIC-M12M5	Male		
	FIC-M12F5	Female		
5-Pin Right-angle	FIC-M12M5A	Male		
	FIC-M12F5A	Female		

Mini-Style Quick-Disconnect Receptacles

Housing: Nickel chrome-plated brass or zinc alloy
Conductors: 20 AWG (3- and 4-pin), or 24 AWG (5-pin), PVC insulation, gold plated pins
Temperature: -40 to +70°C (-40 to +158°F)
Voltage Rating: 600V ac (3-pin), 300V ac (5-pin)





Style	Model	Wire Length	Used with:	Dimensions	Pin-out
3-Pin Male Pin-out	MBC-3	300 mm (12")	<ul style="list-style-type: none"> • MULTI-BEAM • MAXI-BEAM • Q85 series (emitters) 	<p>Side View</p>	<p>Male Pinout</p>
4-Pin Male Pin-out	MBC-4	300 mm (12")	<ul style="list-style-type: none"> • MULTI-BEAM • MAXI-BEAM • Q85 series 		<p>Male Pinout</p>
5-Pin Male Pin-out	MBC-5	60 mm (2.5")	<ul style="list-style-type: none"> • Q85 series 	<p>Side View</p>	<p>Male Pinout</p>





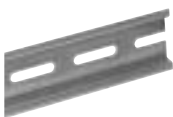
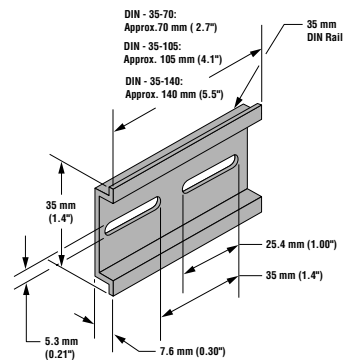

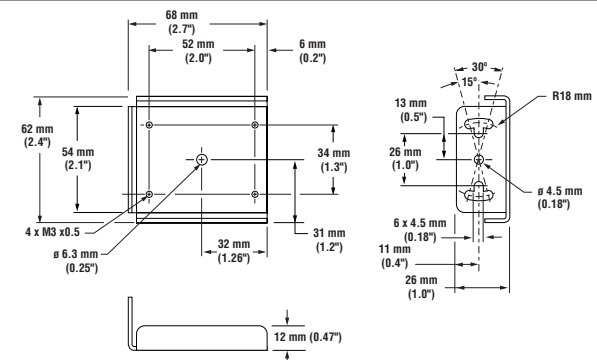
Brackets

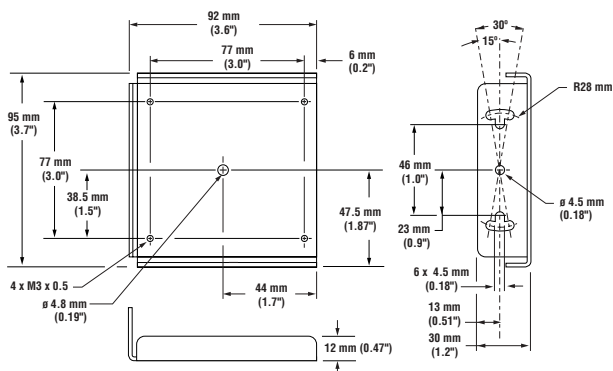

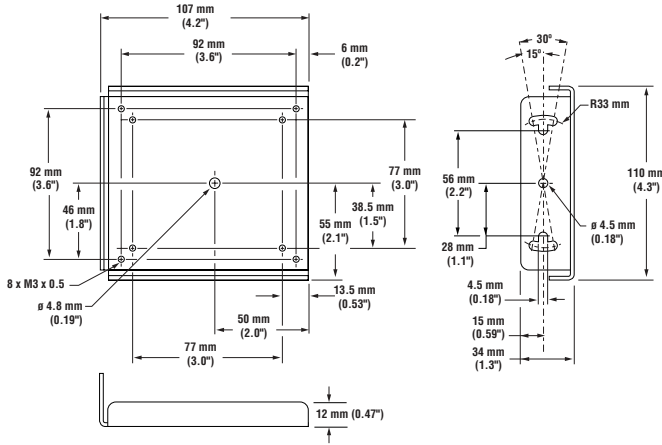

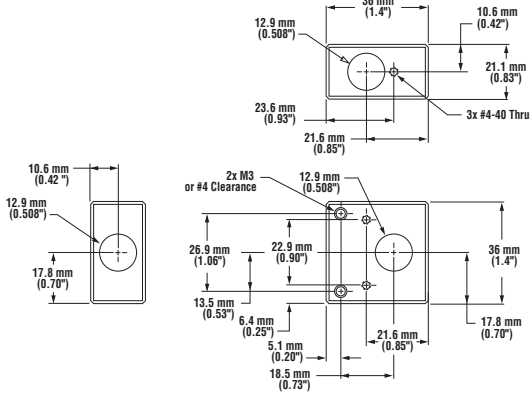

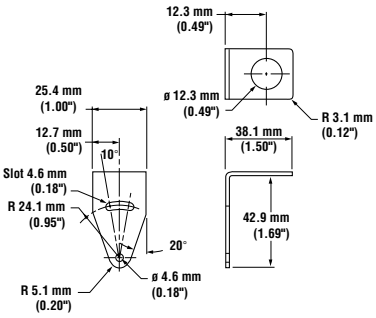

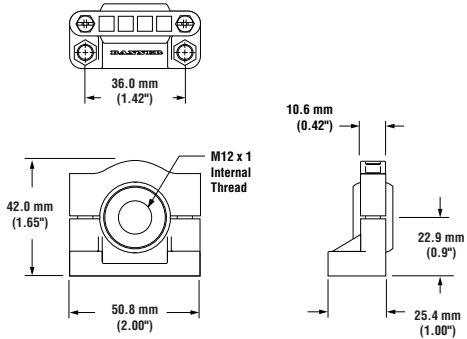

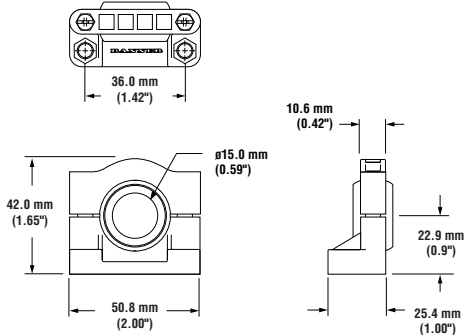

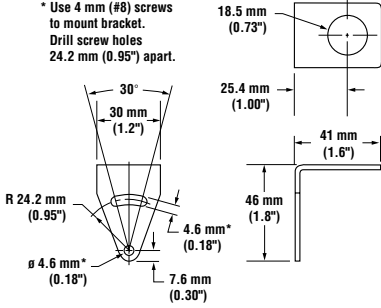

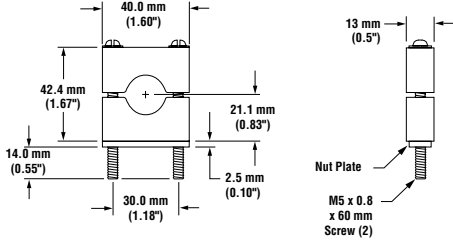
- Choose from a wide selection of sensor mounting brackets
- Most metal brackets are constructed of stainless steel
- Most non-metallic brackets are molded from reinforced thermoplastic polyester, including versatile swivel models

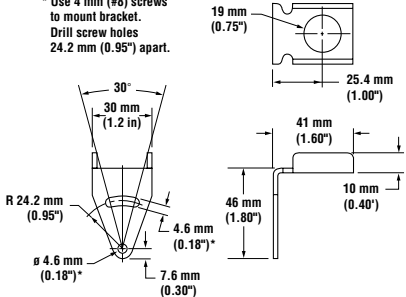

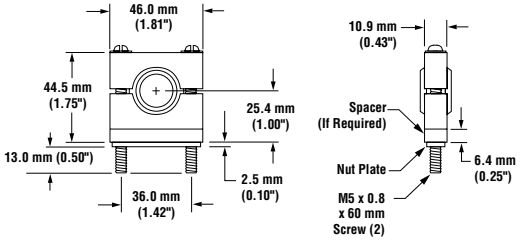

NOTE: See the accessories listing at the end of each product section for additional brackets which are designed specifically for one product family

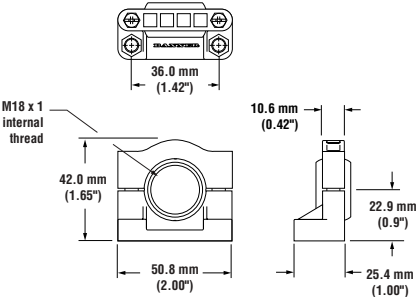

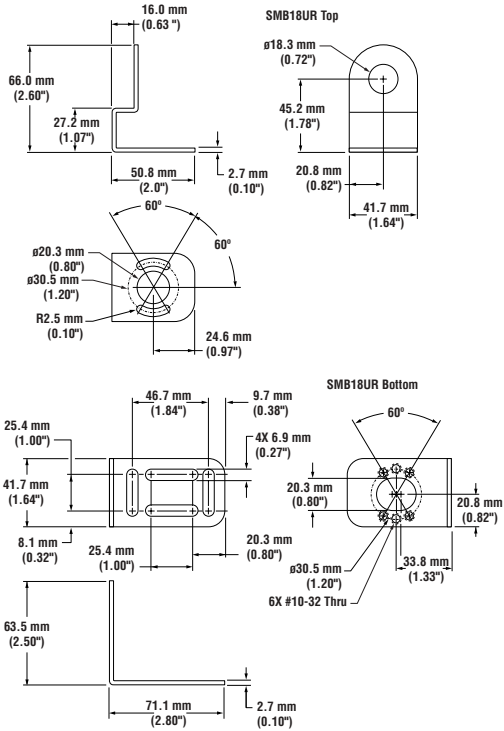

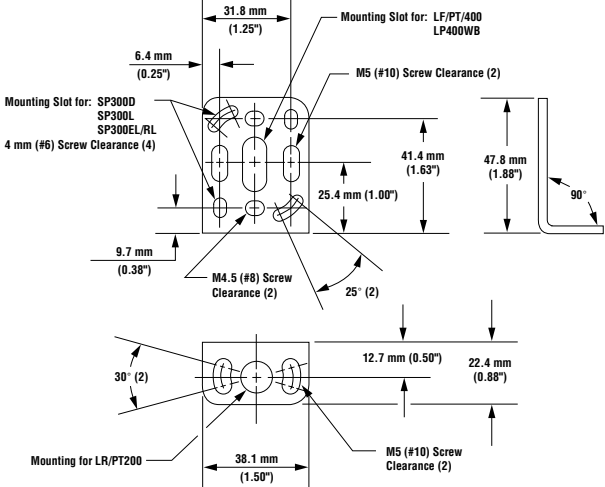
Mounting Brackets			
Model	Description	Used with:	Dimensions
<p>DIN-35-70 DIN-35-105 DIN-35-140</p> 	<p>DIN-35-70: 70 mm (2.7") DIN-35-105: 105 mm (4.1") DIN-35-140: 140 mm (5.5")</p>	<ul style="list-style-type: none"> • D12 • D11 • RS-11 socket • PICO-AMP 	 <p>DIN - 35-70: Approx. 70 mm (2.7") DIN - 35-105: Approx. 105 mm (4.1") DIN - 35-140: Approx. 140 mm (5.5")</p> <p>35 mm DIN Rail</p> <p>35 mm (1.4") 25.4 mm (1.00") 35 mm (1.4") 5.3 mm (0.21") 7.6 mm (0.30")</p>
<p>RMB50</p> 	<ul style="list-style-type: none"> • Protective mounting bracket for retroreflective targets • 14-gauge 316 stainless steel • Stainless steel M3 x 0.5 hardware is included 	<p>The following reflectors:</p> <ul style="list-style-type: none"> • BRT-60X40C • BRT-2X2 • BRT-50D • BRT-50R 	 <p>68 mm (2.7") 52 mm (2.0") 6 mm (0.2") 62 mm (2.4") 54 mm (2.1") 34 mm (1.3") 4 x M3 x 0.5 ø 6.3 mm (0.25") 32 mm (1.26") 31 mm (1.2") 13 mm (0.5") 26 mm (1.0") R18 mm ø 4.5 mm (0.18") 6 x 4.5 mm (0.18") 11 mm (0.4") 26 mm (1.0") 12 mm (0.47")</p>
<p>RMB85</p> 	<ul style="list-style-type: none"> • Protective mounting bracket for retroreflective targets • 14-gauge 316 stainless steel • Stainless steel M3 x 0.5 hardware is included 	<p>The following reflectors:</p> <ul style="list-style-type: none"> • BRT-3 • BRT-77X77C 	 <p>92 mm (3.6") 77 mm (3.0") 6 mm (0.2") 95 mm (3.7") 77 mm (3.0") 38.5 mm (1.5") 46 mm (1.8") 47.5 mm (1.87") 23 mm (0.9") R28 mm ø 4.5 mm (0.18") 6 x 4.5 mm (0.18") 13 mm (0.51") 30 mm (1.2") 12 mm (0.47")</p>

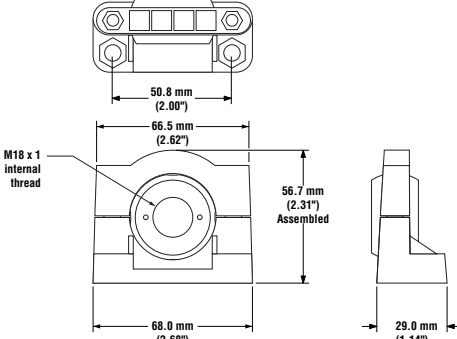

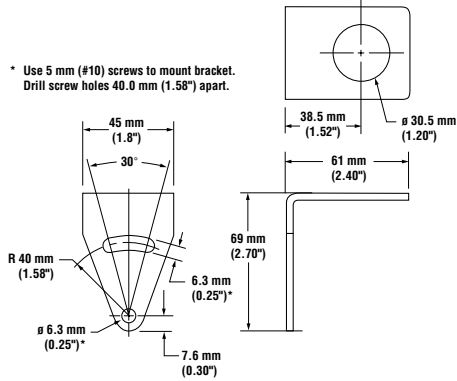
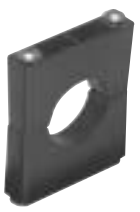
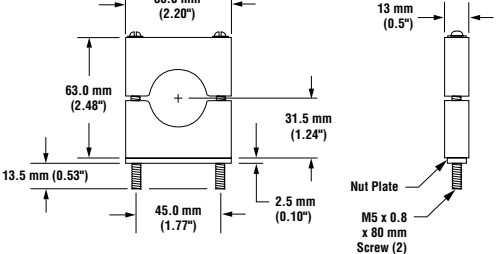

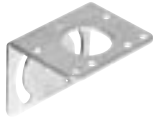
Mounting Brackets			
Model	Description	Used with:	Dimensions
<p>RMB100</p> 	<ul style="list-style-type: none"> Protective mounting bracket for retroreflective targets 14-gauge 316 stainless steel Stainless steel M3 x 0.5 hardware is included 	<p>The following reflectors:</p> <ul style="list-style-type: none"> BRT-92X92C BRT-77X77C BRT-3 BRT-84 	 <p>Technical drawing showing dimensions for the RMB100 mounting bracket. Key dimensions include: 107 mm (4.2") total width, 92 mm (3.6") inner width, 6 mm (0.2") thickness, 92 mm (3.6") height, 46 mm (1.8") mounting hole offset, 77 mm (3.0") distance between mounting holes, 50 mm (2.0") distance between mounting holes, 13.5 mm (0.53") distance between mounting holes, 8 x M3 x 0.5 hardware, 77 mm (3.0") distance between mounting holes, 12 mm (0.47") thickness, 56 mm (2.2") distance between mounting holes, 38.5 mm (1.5") distance between mounting holes, 55 mm (2.1") distance between mounting holes, 28 mm (1.1") distance between mounting holes, 4.5 mm (0.18") distance between mounting holes, 15 mm (0.59") distance between mounting holes, 34 mm (1.3") distance between mounting holes, 110 mm (4.3") total height, 30° angle, 15° angle, R33 mm radius, and 4.5 mm (0.18") diameter hole.</p>
<p>SMB127 Mounting Block</p> 	<ul style="list-style-type: none"> Mounting block Comes with: 3/64" hex wrench, 4 set screws 	<ul style="list-style-type: none"> M12 Laser emitters 	 <p>Technical drawing showing dimensions for the SMB127 mounting block. Key dimensions include: 10.6 mm (0.42") width, 12.9 mm (0.508") height, 17.8 mm (0.70") height, 36 mm (1.4") width, 10.6 mm (0.42") height, 21.1 mm (0.83") height, 23.6 mm (0.93") height, 21.6 mm (0.85") height, 3x #4-40 Thru holes, 12.9 mm (0.508") height, 26.9 mm (1.06") height, 22.9 mm (0.90") height, 36 mm (1.4") width, 17.8 mm (0.70") height, 13.5 mm (0.53") height, 6.4 mm (0.25") height, 5.1 mm (0.20") height, 21.6 mm (0.85") height, 18.5 mm (0.73") height, 2x M3 or #4 Clearance holes, 12.9 mm (0.508") height, 10.6 mm (0.42") width, 17.8 mm (0.70") height, 21.6 mm (0.85") height, 18.5 mm (0.73") height.</p>
<p>SMB12MM</p> 	<ul style="list-style-type: none"> 12-gauge, stainless steel, right angle mounting bracket for barrel style sensors with 12 mm threads Curved mounting slot allows the bracket ±10° of lateral movement Mounting holes accommodate M4 (#8) hardware 	<ul style="list-style-type: none"> S12 SP12 	 <p>Technical drawing showing dimensions for the SMB12MM mounting bracket. Key dimensions include: 12.3 mm (0.49") width, 25.4 mm (1.00") height, 12.7 mm (0.50") height, 10° angle, Slot 4.6 mm (0.18"), R 24.1 mm (0.95") radius, 20° angle, R 5.1 mm (0.20") radius, 4.6 mm (0.18") diameter hole, 12.3 mm (0.49") diameter hole, R 3.1 mm (0.12") radius, 38.1 mm (1.50") height, 42.9 mm (1.69") height.</p>
<p>SMB1812SF</p> 	<ul style="list-style-type: none"> 12 mm swivel Black reinforced thermoplastic polyester Includes stainless steel swivel locking hardware 	<ul style="list-style-type: none"> S12 SP12 	 <p>Technical drawing showing dimensions for the SMB1812SF mounting block. Key dimensions include: 36.0 mm (1.42") width, 42.0 mm (1.65") height, 50.8 mm (2.00") width, 10.6 mm (0.42") height, 22.9 mm (0.9") height, 25.4 mm (1.00") height, M12 x 1 Internal Thread.</p>



Mounting Brackets			
Model	Description	Used with:	Dimensions
<p>SMB1815SF</p> 	<ul style="list-style-type: none"> Swivel with set screws for mounting of T18 or T30 by its cable hub Black reinforced thermoplastic polyester Includes stainless steel swivel locking hardware and 3/64"3 hex wrench 	<ul style="list-style-type: none"> T18 T30 	
<p>SMB18A</p> 	<ul style="list-style-type: none"> 12-gauge, stainless steel, right angle mounting bracket with a curved mounting slot for versatility and orientation Clearance for M4 (#8) hardware 	<ul style="list-style-type: none"> MINI-BEAM M18 Q25 S18 T18 QS18 (select models only) 	<p>* Use 4 mm (#8) screws to mount bracket. Drill screw holes 24.2 mm (0.95") apart.</p> 
<p>SMB18C</p> 	<ul style="list-style-type: none"> 18 mm split clamp bracket Black thermoplastic polyester Includes stainless steel mounting hardware 	<ul style="list-style-type: none"> MINI-BEAM M18 Q25 S18 T18 	
<p>SMB18Q</p> 	<ul style="list-style-type: none"> 18 mm angled flanged bracket for Q25 sensors 12 ga stainless steel 	<ul style="list-style-type: none"> Q25 	<p>* Use 4 mm (#8) screws to mount bracket. Drill screw holes 24.2 mm (0.95") apart.</p> 

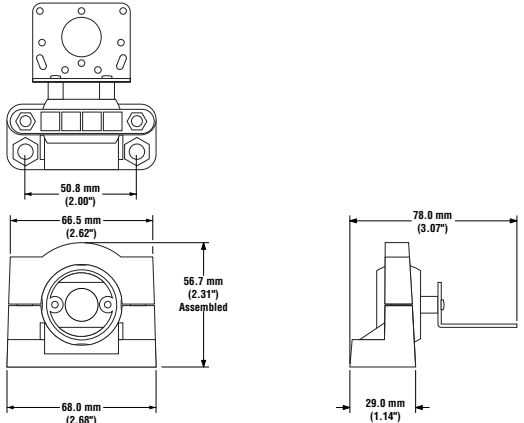

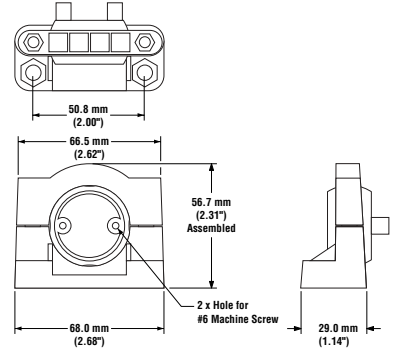

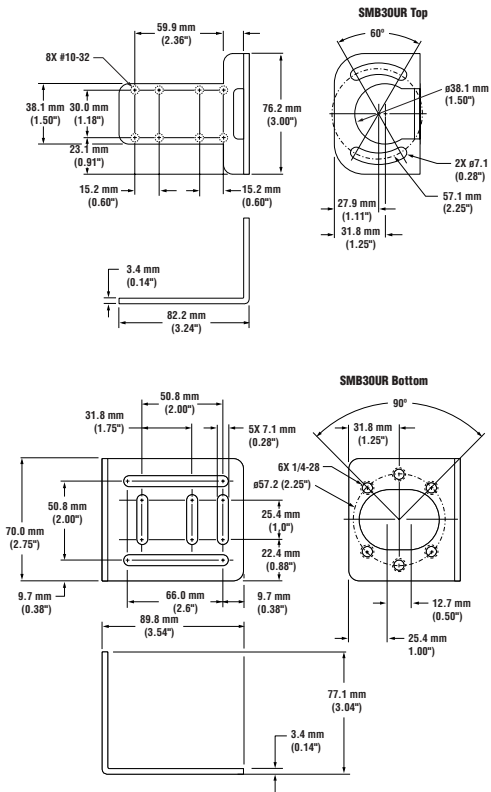
Mounting Brackets			
Model	Description	Used with:	Dimensions
<p>SMB18S</p> 	<ul style="list-style-type: none"> • 18 mm swivel bracket • black thermoplastic polyester • Includes stainless steel mounting hardware 	<ul style="list-style-type: none"> • MINI-BEAM • M18 • Q25 • S18 • T18 	
<p>SMB18SF</p> 	<ul style="list-style-type: none"> • 18 mm swivel bracket • Black thermoplastic polyester • Includes stainless steel swivel locking hardware 	<ul style="list-style-type: none"> • MINI-BEAM • M18 • Q25 • S18 • T18 	
<p>SMB18UR</p> 	<ul style="list-style-type: none"> • 2-piece universal swivel bracket for 18 mm sensors • 300 series stainless steel • Includes stainless steel swivel locking hardware 	<ul style="list-style-type: none"> • MINI-BEAM • M18 • S18 • T18 	



Mounting Brackets			
Model	Description	Used with:	Dimensions
<p>SMB300</p> 	<ul style="list-style-type: none"> • Steel right angle bracket designed for 2-axis mounting • Clearance slot for mounting LR/PT400 	<ul style="list-style-type: none"> • SP300 • LR/PT400 • LP400WB • LR/PT200 	 <p>Dimensions for SMB300 include: 31.8 mm (1.25"), 6.4 mm (0.25"), 41.4 mm (1.63"), 47.8 mm (1.88"), 25.4 mm (1.00"), 9.7 mm (0.38"), 25° (2), 30° (2), 38.1 mm (1.50"), 12.7 mm (0.50"), 22.4 mm (0.88"), 4 mm (#6) Screw Clearance (4), M5 (#10) Screw Clearance (2), M4.5 (#8) Screw Clearance (2), Mounting Slot for: SP300D, SP300L, SP300EL/RL, Mounting Slot for: LF/PT/400, LP400WB, and Mounting for LR/PT200.</p>
<p>SMB3018SC</p> 	<ul style="list-style-type: none"> • 18 mm swivel barrel or side mount bracket • Black reinforced thermoplastic polyester • Includes stainless steel swivel locking hardware 	<ul style="list-style-type: none"> • MINI-BEAM • Q23 • QM42/QMT42 • Q25 • S18 • T18 	 <p>Dimensions for SMB3018SC include: 50.8 mm (2.00"), 66.5 mm (2.62"), 56.7 mm (2.31") Assembled, 68.0 mm (2.68"), 29.0 mm (1.14"), and M18 x 1 internal thread.</p>
<p>SMB30A</p> 	<ul style="list-style-type: none"> • 12-gauge, stainless steel, right angle mounting bracket with a curved mounting slot for versatility and orientation • Clearance for M6 (1/4") hardware 	<ul style="list-style-type: none"> • SM30 • Q40 • S30 • T30 	 <p>* Use 5 mm (#10) screws to mount bracket. Drill screw holes 40.0 mm (1.58") apart.</p> <p>Dimensions for SMB30A include: 45 mm (1.8"), 30°, R 40 mm (1.58"), 6.3 mm (0.25")*, 7.6 mm (0.30"), 69 mm (2.70"), 61 mm (2.40"), 38.5 mm (1.52"), 30.5 mm (1.20"), and 6.3 mm (0.25")*.</p>
<p>SMB30C</p> 	<ul style="list-style-type: none"> • 30 mm split clamp bracket • Black reinforced thermoplastic polyester • Includes stainless steel mounting hardware 	<ul style="list-style-type: none"> • OMNI-BEAM • Q45 • VALU-BEAM • SM30 • S30 • Q40 • T30 • OTB 	 <p>Dimensions for SMB30C include: 56.0 mm (2.20"), 63.0 mm (2.48"), 31.5 mm (1.24"), 13.5 mm (0.53"), 45.0 mm (1.77"), 2.5 mm (0.10"), 13 mm (0.5"), and M5 x 0.8 x 80 mm Screw (2) with Nut Plate.</p>

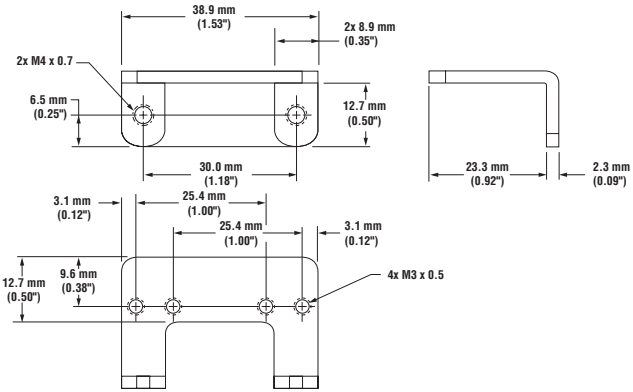

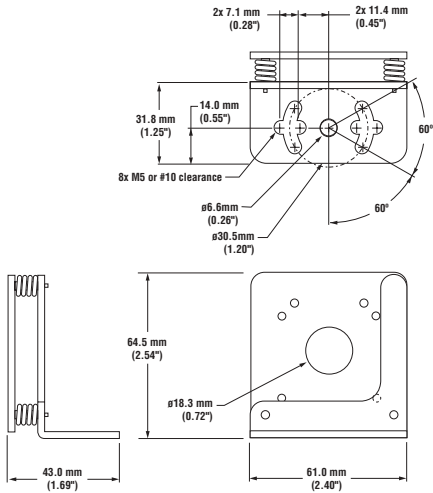

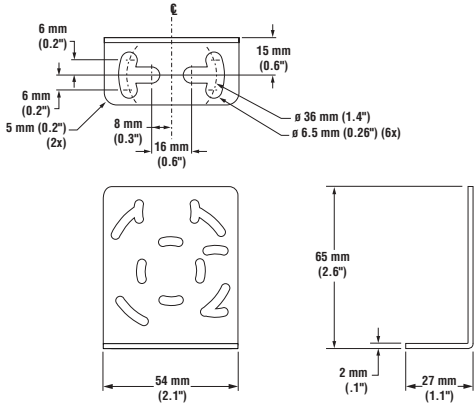
Mounting Brackets			
Model	Description	Used with:	Dimensions
<p>SMB30MM</p> 	<ul style="list-style-type: none"> • 30 mm, 12-gauge, stainless steel bracket with curved mounting slots for versatility and orientation • Clearance for M6 (1/4") hardware 	<ul style="list-style-type: none"> • OMNI-BEAM • Q45 • VALU-BEAM • SM30 • OTB 	
<p>SMB30Q</p> 	<ul style="list-style-type: none"> • 30 mm angled flanged mounting bracket • Black reinforced thermoplastic polyester • Includes stainless steel hardware 	<ul style="list-style-type: none"> • Q40 	<p>* Use 5 mm (#10 screws to mount bracket. Drill screw holes 40.0 mm (1.58") apart.</p>
<p>SMB30S</p> 	<ul style="list-style-type: none"> • 30 mm swivel bracket • Black reinforced thermoplastic polyester • Includes stainless steel mounting and swivel locking hardware 	<ul style="list-style-type: none"> • OMNI-BEAM • Q45 • VALU-BEAM • SM30 • S30 • Q40 • T30 • OTB 	
<p>SMB30SC</p> 	<ul style="list-style-type: none"> • 30 mm swivel bracket • Black reinforced thermoplastic polyester • Includes stainless steel mounting and swivel locking hardware 	<ul style="list-style-type: none"> • OMNI-BEAM • Q45 • VALU-BEAM • SM30 • S30 • Q40 • T30 • OTB 	

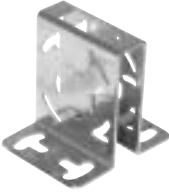





Mounting Brackets			
Model	Description	Used with:	Dimensions
<p>SMB30SK</p> 	<ul style="list-style-type: none"> Flat-mount swivel bracket with extended range of motion Black reinforced thermoplastic polyester and 316 stainless steel Includes stainless steel swivel locking hardware 	<ul style="list-style-type: none"> MINI-BEAM Q23 QM42/QMT42 S18 M18 T18 	 <p>Technical drawings of SMB30SK showing front, side, and top views with dimensions:</p> <ul style="list-style-type: none"> Top view: 50.8 mm (2.00") width, 66.5 mm (2.62") depth, 68.0 mm (2.68") width. Side view: 56.7 mm (2.31") height, 78.0 mm (3.07") depth. Bottom view: 29.0 mm (1.14") width.
<p>SMB30SUS</p> 	<ul style="list-style-type: none"> Side mount swivel bracket – extended range of motion Black reinforced thermoplastic polyester Includes stainless steel swivel locking hardware 	<ul style="list-style-type: none"> MINI-BEAM Q23 QM42 	 <p>Technical drawings of SMB30SUS showing front, side, and top views with dimensions:</p> <ul style="list-style-type: none"> Top view: 50.8 mm (2.00") width, 66.5 mm (2.62") depth, 68.0 mm (2.68") width. Side view: 56.7 mm (2.31") height, 29.0 mm (1.14") width. Bottom view: 29.0 mm (1.14") width. Note: 2 x Hole for #6 Machine Screw
<p>SMB30UR</p> 	<ul style="list-style-type: none"> 2-piece universal swivel bracket for limit-switch style sensors 300 series stainless steel Includes stainless steel swivel locking hardware 	<ul style="list-style-type: none"> MULTI-BEAM MAXI-BEAM Q45 OMNI-BEAM LS10 	 <p>Technical drawings of SMB30UR showing top and bottom views with dimensions:</p> <ul style="list-style-type: none"> SMB30UR Top: 59.9 mm (2.36") width, 76.2 mm (3.00") height, 82.2 mm (3.24") depth, 3.4 mm (0.14") thickness. Features 8X #10-32 holes, 38.1 mm (1.50") hole spacing, 30.0 mm (1.18") hole diameter, 23.1 mm (0.91") hole offset, 15.2 mm (0.60") hole diameter, 15.2 mm (0.60") hole offset, 27.9 mm (1.11") hole diameter, 31.8 mm (1.25") hole diameter, 57.1 mm (2.25") hole diameter, 2X #7.1 (0.28") holes, 60° angle. SMB30UR Bottom: 50.8 mm (2.00") width, 70.0 mm (2.75") height, 89.8 mm (3.54") depth, 3.4 mm (0.14") thickness. Features 5X 7.1 mm (0.28") holes, 31.8 mm (1.25") hole diameter, 6X 1/4-28 holes, 57.2 mm (2.25") hole diameter, 25.4 mm (1.0") hole diameter, 22.4 mm (0.88") hole diameter, 9.7 mm (0.38") hole diameter, 9.7 mm (0.38") hole offset, 12.7 mm (0.50") hole diameter, 25.4 mm (1.00") hole diameter, 90° angle.



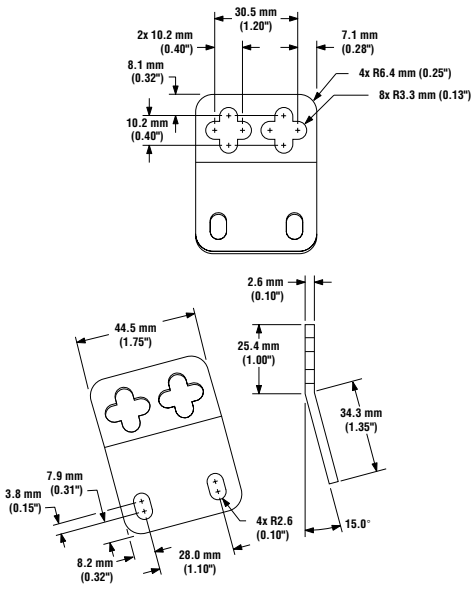

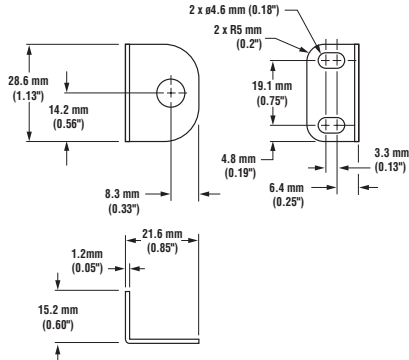

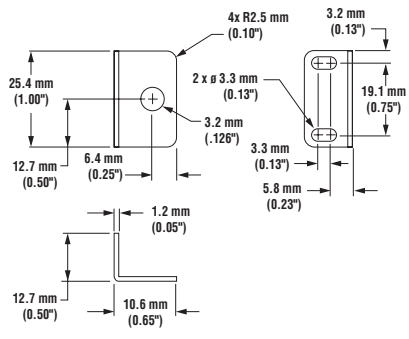
Mounting Brackets			
Model	Description	Used with:	Dimensions
<p>SMB42F</p> 	<ul style="list-style-type: none"> • 13-gauge stainless steel • Includes mounting hardware 	<ul style="list-style-type: none"> • QM42/QMT42 	
<p>SMB42L</p> 	<ul style="list-style-type: none"> • 13-gauge stainless steel • Includes mounting hardware 	<ul style="list-style-type: none"> • QM42/QMT42 	
<p>SMB42T</p> 	<ul style="list-style-type: none"> • 2-axis side mounting bracket • Stainless steel • Includes M3 sensor mounting hardware 	<ul style="list-style-type: none"> • QM42/QMT42 	

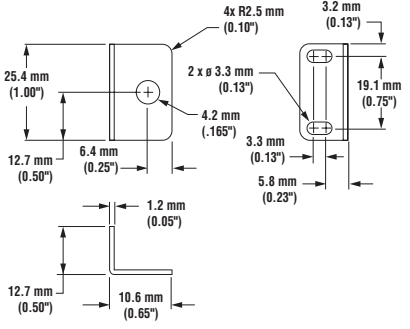

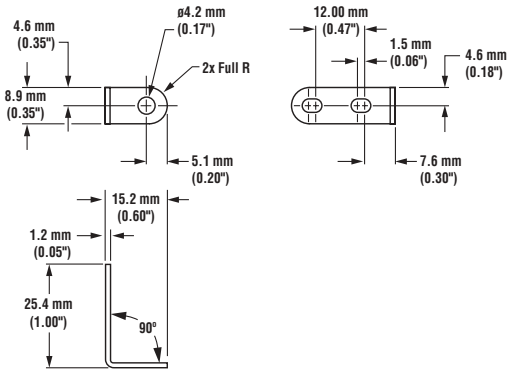

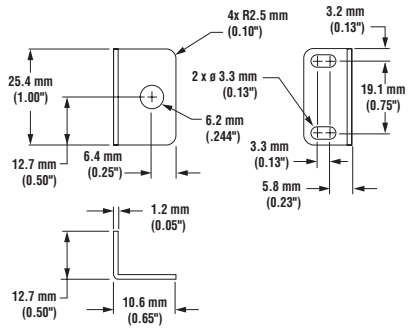
Mounting Brackets			
Model	Description	Used with:	Dimensions
<p>SMB42U</p> 	<ul style="list-style-type: none"> • 13-gauge stainless steel • Includes mounting hardware 	<ul style="list-style-type: none"> • QM42/QMT42 	
<p>SMB46A</p> 	<ul style="list-style-type: none"> • 2-piece 12-gauge, stainless steel bracket assembly with precision sensor alignment adjustment • Includes 2 mm hex key 	<ul style="list-style-type: none"> • S186ELD • PicoDot 	
<p>SMB46DF</p> 	<ul style="list-style-type: none"> • “L” bracket • 14-gauge 316 stainless steel 	<ul style="list-style-type: none"> • MINI-BEAM • PicoDot • Q23 Series • QM42/QMT42 • Q14 	

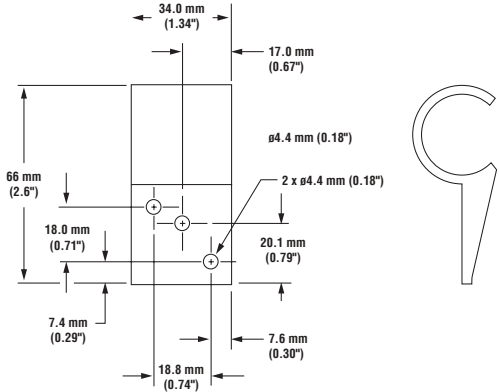

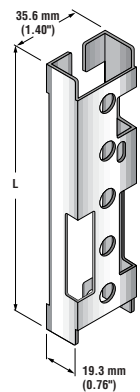

Mounting Brackets			
Model	Description	Used with:	Dimensions
<p>SMB46S</p> 	<ul style="list-style-type: none"> • “S” bracket • 14-gauge 316 stainless steel 	<ul style="list-style-type: none"> • MINI-BEAM • PicoDot • Q23/QH23 • QM42/QMT42 • Q14 	
<p>SMB46U</p> 	<ul style="list-style-type: none"> • “U” bracket • 14-gauge 316 stainless steel 	<ul style="list-style-type: none"> • “U” bracket • 14-gauge 316 stainless steel 	
<p>SMB46X3</p> 	<ul style="list-style-type: none"> • Assembly with mounting block and adjustable bracket • Includes: <ul style="list-style-type: none"> - 2 mm hex key - 3/64" hex key 4 set screws 	<ul style="list-style-type: none"> • M12 Laser emitters 	

Mounting Brackets			
Model	Description	Used with:	Dimensions
SMB500 	<ul style="list-style-type: none"> • Universal steel mounting bracket 	<ul style="list-style-type: none"> • SM512 	
SMB55A 	<ul style="list-style-type: none"> • 15° offset bracket • 12-gauge stainless steel 	<ul style="list-style-type: none"> • R55 	
SMB55F 	<ul style="list-style-type: none"> • Flat mount bracket • 12-gauge stainless steel 	<ul style="list-style-type: none"> • R55 	
SMB55RA 	<ul style="list-style-type: none"> • 90° offset bracket • 12-gauge stainless steel 	<ul style="list-style-type: none"> • R55 	

Mounting Brackets			
Model	Description	Used with:	Dimensions
<p>SMB55S</p> 	<ul style="list-style-type: none"> • 15° offset bracket • 12-gauge stainless steel 	<ul style="list-style-type: none"> • R55 	
<p>SMBF</p> 	<ul style="list-style-type: none"> • Right angle bracket for glass fiber optics with 5/16" - 24 threaded tip • 18-gauge stainless steel 	<ul style="list-style-type: none"> • Glass fiber with 5/16" - 24 tip 	
<p>SMBFP3</p> 	<ul style="list-style-type: none"> • Right angle bracket for plastic fiber optics with 3 mm threaded tip • 18-gauge stainless steel 	<ul style="list-style-type: none"> • Plastic fiber with M3 tip 	
<p>SMBFP4</p> 	<ul style="list-style-type: none"> • Right angle bracket for plastic fiber optics with 4 mm threaded tip • 18-gauge stainless steel 	<ul style="list-style-type: none"> • Plastic fiber with M4 tip 	

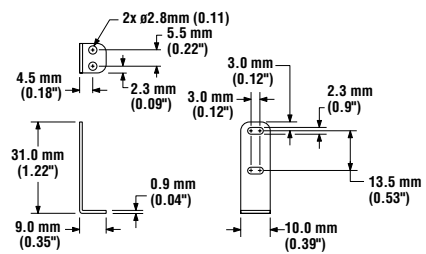
Mounting Brackets																		
Model	Description	Used with:	Dimensions															
SMBFP4N 	<ul style="list-style-type: none"> • Low profile bracket for plastic fiber optics with 4 mm threaded tip • 18-gauge stainless steel 	<ul style="list-style-type: none"> • Plastic fiber with M4 tip 																
SMBFP6 	<ul style="list-style-type: none"> • Right angle bracket for plastic fiber optics with 6 mm threaded tip • 18-gauge stainless steel 	<ul style="list-style-type: none"> • Plastic fiber with M6 tip 																
SMBPVA2 	<ul style="list-style-type: none"> • Set of 4 molded brackets • Snaps onto standard 28 mm diameter pipe • 2 required per PVA sensor 	<ul style="list-style-type: none"> • PVA 																
SMBPVA5 SMBPVA10 SMBPVA13 SMBPVA16 	<ul style="list-style-type: none"> • Set of 2 heavy-duty protective brackets for PVA sensors • Cold-rolled plated steel 	<ul style="list-style-type: none"> • PVA 	 <table border="1" data-bbox="1031 1533 1437 1753"> <thead> <tr> <th>Model</th> <th>Used With</th> <th>“L”</th> </tr> </thead> <tbody> <tr> <td>SMBPVA5</td> <td>PVA100</td> <td>139.7 mm</td> </tr> <tr> <td>SMBPVA10</td> <td>PVA225</td> <td>268.2 mm</td> </tr> <tr> <td>SMBPVA13</td> <td>PVA300</td> <td>343.3 mm</td> </tr> <tr> <td>SMBPVA16</td> <td>PVA375</td> <td>418.2 mm</td> </tr> </tbody> </table>	Model	Used With	“L”	SMBPVA5	PVA100	139.7 mm	SMBPVA10	PVA225	268.2 mm	SMBPVA13	PVA300	343.3 mm	SMBPVA16	PVA375	418.2 mm
Model	Used With	“L”																
SMBPVA5	PVA100	139.7 mm																
SMBPVA10	PVA225	268.2 mm																
SMBPVA13	PVA300	343.3 mm																
SMBPVA16	PVA375	418.2 mm																

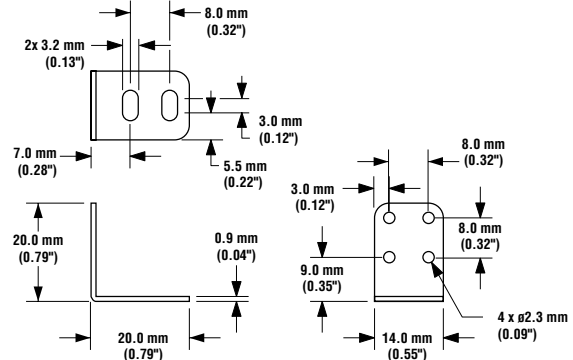
Mounting Brackets			
Model	Description	Used with:	Dimensions
<p>SMBSP3</p> 	<ul style="list-style-type: none"> • Right angle bracket • Stainless steel 	<ul style="list-style-type: none"> • SP3 • SP8 	
<p>SMBVS1S</p> 	<ul style="list-style-type: none"> • Short bracket • 18-gauge stainless steel 	<ul style="list-style-type: none"> • VS1 	
<p>SMBVS1SC</p> 	<ul style="list-style-type: none"> • Short bracket • 18-gauge stainless steel 	<ul style="list-style-type: none"> • VS1 	
<p>SMBVS1T</p> 	<ul style="list-style-type: none"> • Tall bracket • Stainless steel 	<ul style="list-style-type: none"> • VS1 	

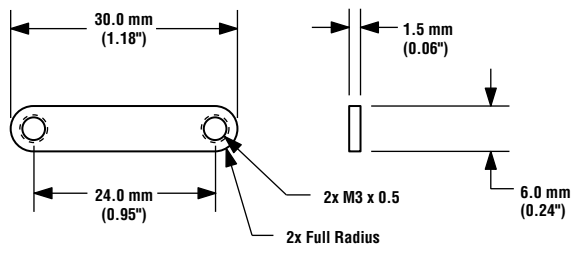
Mounting Brackets			
Model	Description	Used with:	Dimensions
<p>SMBVS1TC</p> 	<ul style="list-style-type: none"> Tall compact bracket 300 Stainless steel 	<ul style="list-style-type: none"> VS1 	
<p>SMBVS2RA</p> 	<ul style="list-style-type: none"> Right-angle bracket Stainless steel 	<ul style="list-style-type: none"> VS2 	
<p>SMH241F</p> 	<ul style="list-style-type: none"> Nut strap replaces two M3 mounting nuts and washers 16-gauge stainless steel 	<ul style="list-style-type: none"> MINI-BEAM Q23 QM42/QMT42 	

BT-1 BEAM-TRACKER

Wireless Photoelectric Diagnostics Sensor

- A quick and simple way to evaluate photoelectric system performance
- Receives light from all modulated photoelectric emitters and transmits light to receivers to check system operation
- Built-in high frequency emitter that will be detected by any Banner photoelectric receiver, as well as by those of most other photoelectric manufacturers
- A valuable tool for locating the center of the beam when installing long-range opposed mode photoelectric sensor pairs
- Locates sources of severe EMI or RFI “noise”
- Low cost, battery operated, and completely self-contained



BT-1 BEAM TRACKER Specifications

Model Number	BT-1
Supply Voltage and Current	9V battery which provides about 10 hours of continuous use (or, typically hundreds of tests)
Indicators	Exclusive, patented Alignment Indicating Device system (AID™, US patent #4356393) which displays the relative strength of the light which it receives from a modulated source. When the receive button is depressed, an LED indicates the presence of a modulated light beam and flashes at a rate which corresponds directly to the beam's intensity. As a result, a suspected weak or failed light source is easily verified.
Beam	BEAM TRACKER emits a 70kHz modulated infrared beam Most modulated photoelectric receivers, if functioning properly, will respond to this beam at close range.
Construction	Housed in a rugged Cylolac™ case, which includes an aiming sight, plus a convenient mounting hole for a strap or cord. Totally self-contained.
Application Notes	In the receive mode, the BEAM TRACKER will respond to a severe level of electromagnetic or radio frequency interference. The path of the “noise” source can be traced by observing the flash rate of the BEAM TRACKER's Alignment Indicating Device.

Cylolac® is a registered trademark of General Electric Co.

BT-1 BEAM-TRACKER Features

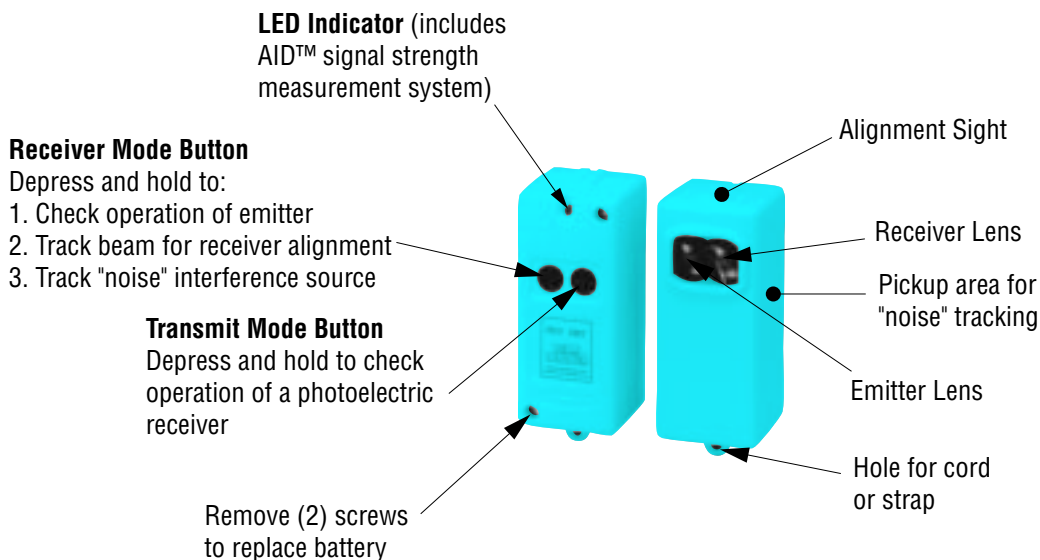

LAT-1 Laser Alignment Tool

Visible Laser Device for Aligning Light Screen Systems



- Totally self-contained visible-beam laser tool simplifies the alignment of any opposed-mode sensor pair
- Uses one common 9-volt battery (included)
- Built-in circular bubble level
- Retroreflective target material included for easy viewing of the laser spot at long distances

LAT-1 Laser Alignment Tool Specifications

Supply Voltage and Current	One standard 9V battery, included (replaceable); approximately 20 hours of continuous operation
Sensing Beam	Class 2 laser, 640-660 nm visible red IEC Pulse Width: 7µs Rep rate: 30µs Peak output power: 2.8 mW, 33kHz, 25% duty cycle
Beam Size at Aperture	Approximately 2 mm (0.08") diameter
Beam Divergence	± 1.0 milliradian within specified temperature range ± 0.5 milliradians at room temperature
Beam Placement	Within ± 4 milliradians (approximately ±0.25 degrees) of parallel to front, back, top and bottom of housing
Construction	Aluminum housing; black anodized finish Black polypropylene cover with flexible hinge for battery access
Environmental Rating	NEMA 1; IEC IP50
Operating Conditions	Temperature: 0° to +40°C (+32° to 104°F) Maximum Relative Humidity: 90% @ +50°C (non-condensing)
Laser Classification	U.S. Safety Standards 21 CFR 1040.10 European Standards EN 60825-1:1994

LAT-1 Laser Alignment Tool Dimensions and Features

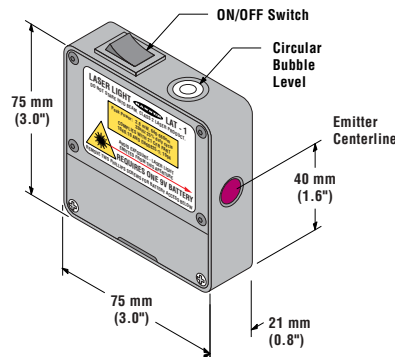
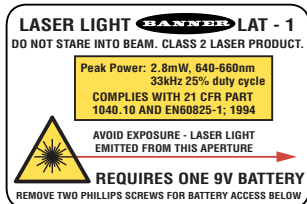

DBQ5 Portable Demo Box

- Used to power dc self-contained photoelectric sensors for testing purposes
- Designed around the 4-pin euro-style connector
- Powered by three standard 9V batteries (27V dc) for very long service life
- Features bi-color LEDs which indicate not only sensor output status, but also output type (NPN or PNP)
- Cable adapters are available to convert to pico-style or mini-style connectors
- A 4-pin wiring barrier is mounted on the top of the box to allow connection of cabled dc sensors



Demo Box

Model	Dimensions
DBQ5	114 mm wide x 62 mm deep x 47 mm high (4.5" x 2.4" x 1.9")

Cable Adapters

Part Number	Type	Used for:
39536	Euro-to-pico	D11, D12, Q23, S12, MINI-BEAM2 and PICO-AMP series sensors
39537	Euro-to-mini	VALU-BEAM, Q45 series, SM30 dc series OPTO-TOUCH and OMNI-BEAM sensors

SPS100 DC Sensor Power Supply



- Converts 120V ac line voltage to low voltage dc for powering any Banner dc sensor† which has either 4- or 5-pin Euro-style quick-disconnect (QD)
- SPS100 models include 5 amp-rated SPDT relay for switching ac loads or large dc loads
- SPS100S models include an optically-isolated SPST solid-state output for switching ac or dc loads
- Models with “Q” suffix require a sensor with a pigtail QD connector; models with “QP” suffix connect to a sensor with either an integral or pigtail quick-disconnect

† Note: SPS power supplies are not for use with NAMUR sensors or personal safety products.

SPS100 Sensor Power Supply Models

Model	Supply Voltage	Sensor Connection	Supply/Output Cable	Output Type
SPS100Q	105-130V ac 60 Hz	5-pin Euro-style QD*	5-pin Mini QD	“Form C” (SPDT) electromechanical relay (see specifications for rating information)
SPS100QP		5-pin Pigtail Euro-style QD		
SPS100SQ		5-pin Euro-style QD*	4-pin Mini QD	SPST Optically-isolated solid-state switch (see specifications for rating information)
SPS100SQP		5-pin Pigtail Euro-style QD		

*Requires 4- or 5-pin Pigtail Euro QD on sensor.

SPS100 Sensor Power Supply Dimensions

Model Suffix “Q”

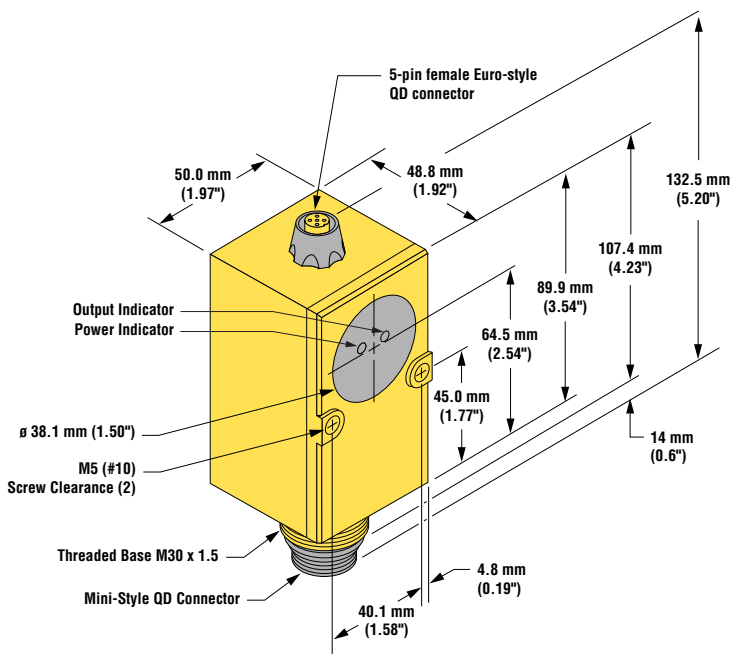

Model Suffix “QP”

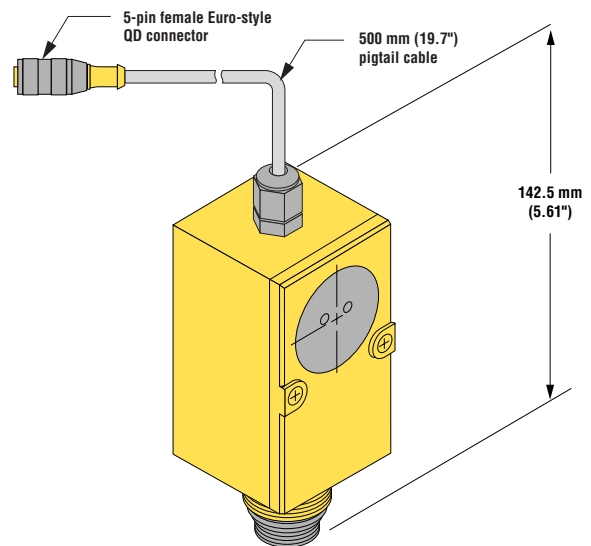

SPS100 Sensor Power Supply Specifications

Supply Voltage	105V ac to 130V ac, 60Hz
Output Power	120mA maximum: 12V dc minimum, 30V dc maximum (dependent on load)
Output Configuration	SPS100Q(P) models: “Form C” (SPDT) electromechanical relay SPS100SQ(P) models: Optically isolated SPST solid-state switch
Output Rating	SPS100Q(P) models: Max. switching power (resistive load) = 150 W, 600 VA Max. switching voltage (resistive load) = 250V ac or 30 V dc (120V ac max. per UL & CSA) Max. switching current (resistive load) = 5A Min. voltage and current = 1 amp at 5V dc, 0.1 amp at 24V dc Peak switching voltage = 750V ac (transient suppression recommended) Mechanical life of relay = 10,000,000 operations SPS100SQ(P) models: Max. switching voltage = 250V ac or 250V dc Max. switching current = 150mA at 25°C, derated to 80 mA at 50°C On-state saturation voltage = less than 3V at 150 mA; less than 1V at 10 mA
Status Indicators	Power On (green) and Output On (red)
Connections	Power connector: SPS100Q(P) models: 5-pin Mini-style quick disconnect SPS100SQ(P) models: 4-pin Mini-style quick disconnect Sensor connector: “Q” version: 5-pin Euro-style quick-disconnect mounted on housing “QP” version: PVC jacketed 5-pin pigtail Euro-style quick-disconnect 0.5 meter long
Environmental Rating	IEC IP54
Operating Conditions	Temperature: -20° to +50°C (-20° to 122°F) Maximum Relative Humidity: 90% @ +50°C (non-condensing)
Additional Notes	Compatible with Banner dc sensors with NPN or PNP output, equipped with 4- or 5-pin Euro-style quick-disconnect (except NAMUR sensors). Model SPS100Q: connects only to sensors equipped with a pigtail Euro-style quick-disconnect Model SPS100QP: connects to sensors equipped with either a pigtail or sensor-mounted Euro-style quick-disconnect Model SPS100SQ: connects only to sensors equipped with a pigtail Euro-style quick-disconnect Model SPS100SQP: connects to sensors equipped with either a pigtail or sensor-mounted Euro-style quick-disconnect

SPS100 Sensor Power Supply Hookups

SPS100 Mechanical Relay

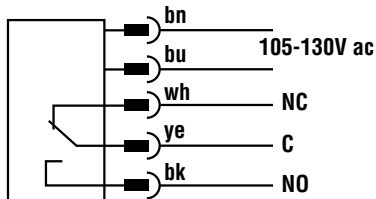

SPS100 Solid-State Relay

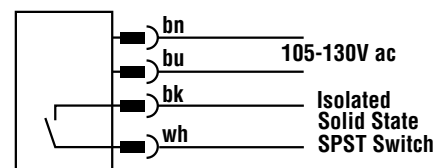

Quick-Disconnect (QD) Cables

Following is the selection of cables available for SPS100 models. See the Accessories on page 726 for more information.

Style	Model	Length	Connector	Used with:
4-Pin Mini	MBCC-406	2 m (6.5')	Straight	SPS100SQ, SPS100SQP
	MBCC-412	4 m (12')		
	MBCC-430	9 m (30')		
5-Pin Mini	MBCC-506	2 m (6.5')	Straight	SPS100Q, SPS100QP
	MBCC-512	4 m (12')		
	MBCC-530	9 m (30')		

NOTES:

NOTES:

NOTES: