

# Spezifikation für Freigabe / specification for release

Kunde / customer :

Artikelnummer / part number :

**7445402**



Bezeichnung : **SPEICHERDROSSEL WE-PD 3**

description : **POWER-CHOKE WE-PD 3**

**WÜRTH ELEKTRONIK**

DATUM / DATE : 2006-09-27

## A Mechanische Abmessungen / dimensions :

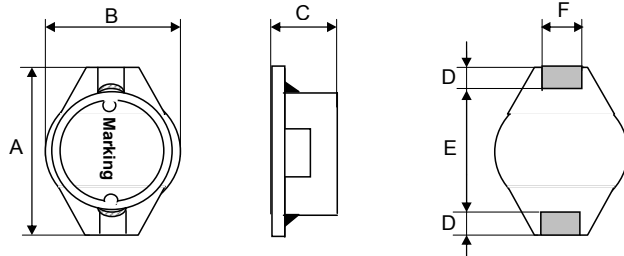

Marking = Inductance code

| Typ L |                   |    |
|-------|-------------------|----|
| A     | <b>12,7 ± 0,2</b> | mm |
| B     | <b>10,0 ± 0,2</b> | mm |
| C     | <b>4,9 ± 0,3</b>  | mm |
| D     | <b>2,4 ± 0,2</b>  | mm |
| E     | <b>7,6 ± 0,3</b>  | mm |
| F     | <b>2,0 ref.</b>   | mm |
|       |                   |    |
|       |                   |    |

## B Elektrische Eigenschaften / electrical properties :

## C Lötpad / soldering spec. :

| Eigenschaften / properties               | Testbedingungen / test conditions |                     | Wert / value | Einheit / unit | tol.  |
|--|-----------------------------------|---------------------|--------------|----------------|-------|
| Induktivität / inductance                | <b>100 kHz / 0,1V</b>             | L                   | <b>2,20</b>  | µH             | ± 20% |
| DC-Widerstand / DC-resistance            | <b>@ 20° C</b>                    | R <sub>DC typ</sub> | <b>0,023</b> | Ω              | typ.  |
| DC-Widerstand / DC-resistance            | <b>@ 20° C</b>                    | R <sub>DC max</sub> | <b>0,027</b> | Ω              | max.  |
| Nennstrom / rated current                | <b>ΔT=40 K</b>                    | I <sub>DC</sub>     | <b>3,80</b>  | A              | max.  |
| Sättigungsstrom / saturation current     | <b> ΔL/L &lt;10%</b>              | I <sub>sat</sub>    | <b>6,80</b>  | A              | typ.  |
| Eigenres.-Frequenz / self-res.-frequency |                                   | SRF                 | <b>108,0</b> | MHz            | typ.  |

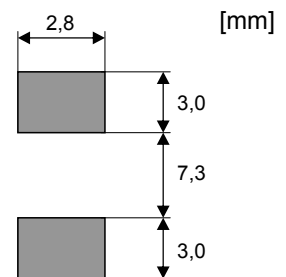

## D Prüfgeräte / test equipment :

## E Testbedingungen / test conditions :

HP 4274 A für/for L und/and Q  
HP 34401 A für/for I<sub>DC</sub> und/and R<sub>DC</sub>

Luftfeuchtigkeit / humidity: 33%  
Umgebungstemperatur / temperature: +20°C

## F Werkstoffe & Zulassungen / material & approvals :

## G Eigenschaften / granted properties :

Basismaterial / base material: Ferrit / ferrite  
 Draht / wire: 2 UEWF 155°C  
 Sockel / Base: UL94-V0  
 Endoberfläche / finishing electrode: 100% Sn  
 Anbindung an Elektrode / soldering wire to plating: Sn/Cu - 97/3%

Betriebstemp. / operating temperature: -40°C - + 125°C  
 Umgebungstemp. / ambient temperature: -40°C - + 85°C  
 It is recommended that the temperature of the part does not exceed 125°C under worst case operating conditions.

|                                     |                          |           |                                      |
|-------------------------------------|--------------------------|-----------|--------------------------------------|
| Freigabe erteilt / general release: | Kunde / customer         |           |                                      |
|                                     |                          |           |                                      |
|                                     |                          |           |                                      |
| Datum / date                        | Unterschrift / signature |           |                                      |
|                                     | Würth Elektronik         |           |                                      |
|                                     | SSt                      | Version 2 | 06-09-27                             |
|                                     | MST                      | Version 1 | 04-10-11                             |
| Geprüft / checked                   | Kontrolliert / approved  | Name      | Änderung / modification Datum / date |

### Würth Elektronik eiSos GmbH & Co. KG

D-74638 Waldenburg · Max-Eyth-Strasse 1 · Germany · Telefon (+49) (0) 7942 - 945 - 0 · Telefax (+49) (0) 7942 - 945 - 400  
<http://www.we-online.com>

# Spezifikation für Freigabe / specification for release

Kunde / customer : \_\_\_\_\_  
 Artikelnummer / part number : **7445402**  
 Bezeichnung : **SPEICHERDROSSEL WE-PD 3**  
 description : **POWER-CHOKE WE-PD 3**



DATUM / DATE : 2006-09-27

## H Induktivitätskurve / Inductance curve :

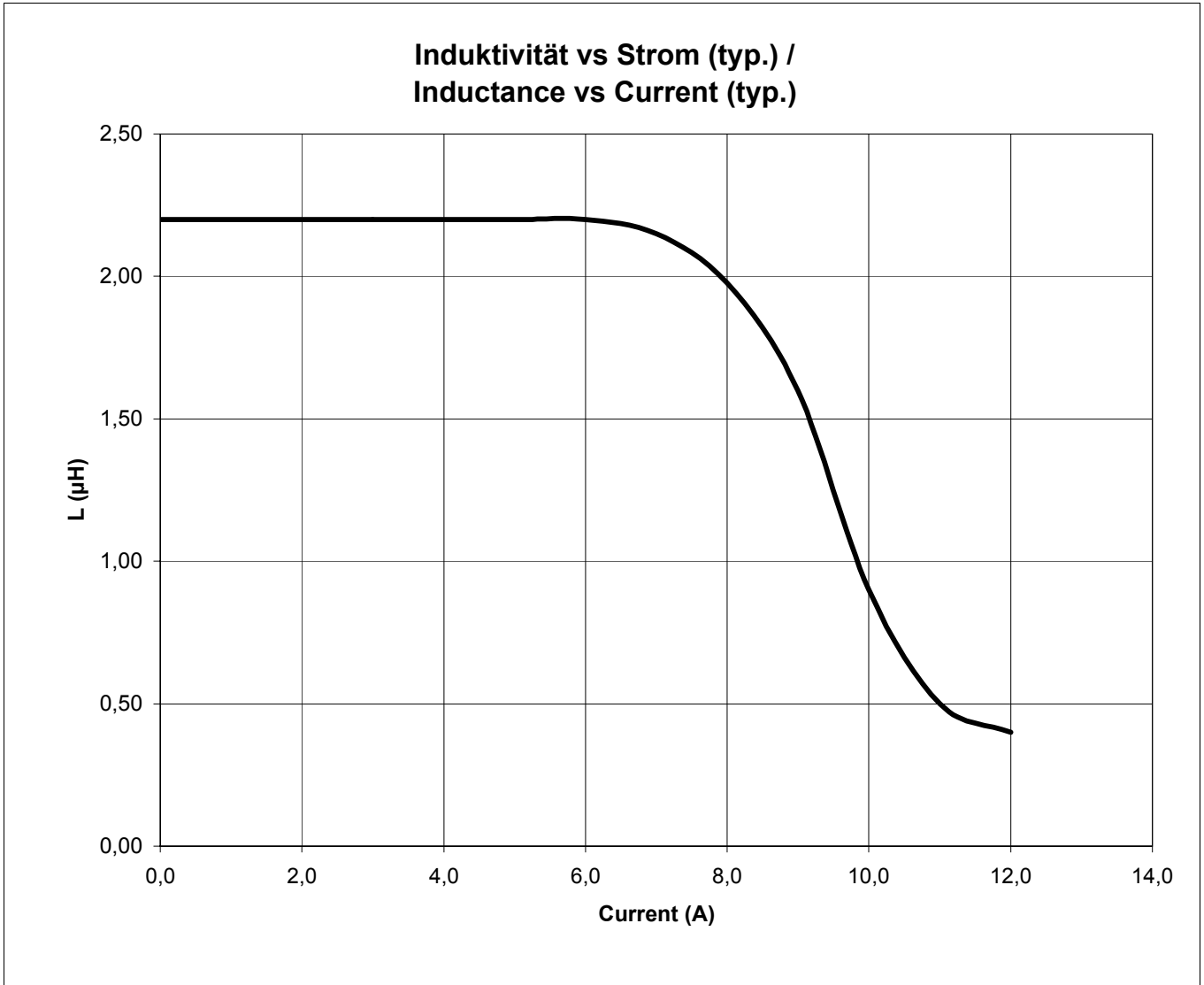

|                                     |                          |      |                         |              |
|-------------------------------------|--------------------------|------|-------------------------|--------------|
| Freigabe erteilt / general release: | <b>Kunde / customer</b>  |      |                         |              |
| Datum / date                        | Unterschrift / signature |      |                         |              |
|                                     | <b>Würth Elektronik</b>  |      |                         |              |
| Geprüft / checked                   | Kontrolliert / approved  | SSt  | Version 2               | 06-09-27     |
|                                     |                          | MST  | Version 1               | 04-10-11     |
|                                     |                          | Name | Änderung / modification | Datum / date |

**Würth Elektronik eiSos GmbH & Co. KG**

D-74638 Waldenburg · Max-Eyth-Strasse 1 · Germany · Telefon (+49) (0) 7942 - 945 - 0 · Telefax (+49) (0) 7942 - 945 - 400  
<http://www.we-online.com>

# Spezifikation für Freigabe / specification for release

Kunde / customer : \_\_\_\_\_  
 Artikelnummer / part number : **7445402**  
 Bezeichnung : **SPEICHERDROSSEL WE-PD 3**  
 description : **POWER-CHOKE WE-PD 3**



DATUM / DATE : 2006-09-27

## I Rollenspezifikation / Tape and reel specification :

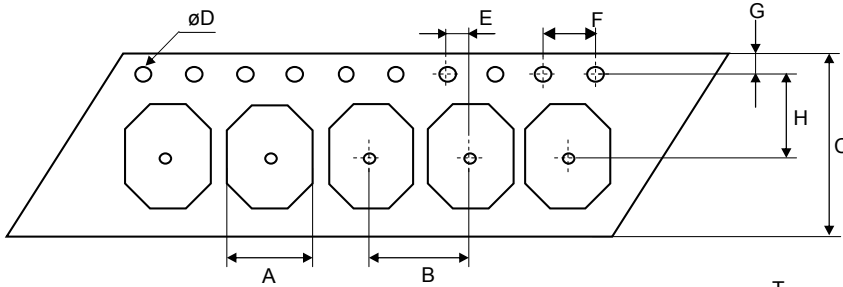

| Gurtspezifikation / Tape specification: |                    |    |
|---|--------------------|----|
| A                                       | <b>10,4 ± 0,1</b>  | mm |
| B                                       | <b>16,0 ± 0,1</b>  | mm |
| C                                       | <b>24,0 ± 0,3</b>  | mm |
| D                                       | <b>1,55 ± 0,05</b> | mm |
| E                                       | <b>2,00 ± 0,1</b>  | mm |
| F                                       | <b>4,00 ± 0,1</b>  | mm |
| G                                       | <b>1,75 ± 0,1</b>  | mm |
| H                                       | <b>11,5 ± 0,1</b>  | mm |
| I                                       | <b>13,2 ± 0,1</b>  | mm |
| J                                       | <b>5,30 ± 0,1</b>  | mm |
| T                                       | <b>0,40 ± 0,05</b> | mm |

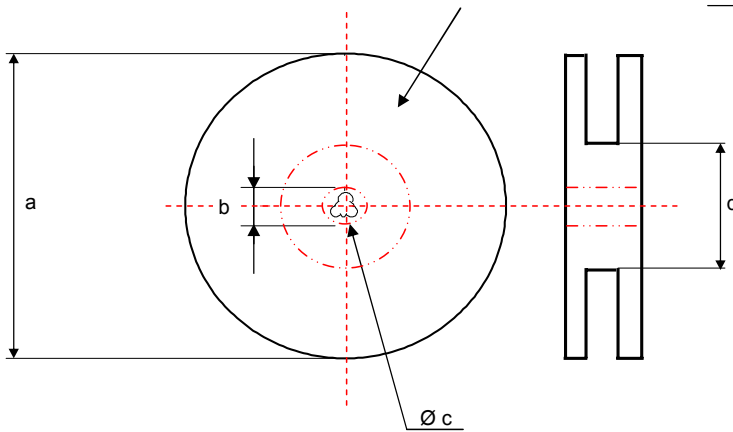
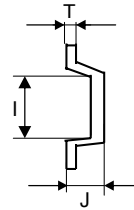

| Rollenspezifikation / Reel specification: |                             |    |
|---|-----------------------------|----|
| a   | <b>330,0 ± 0,5</b>          | mm |
| b   | <b>21,00 ± 0,8</b>          | mm |
| c   | <b>13,00 +0,5<br/>- 1,0</b> | mm |
| d   | <b>100,0 ± 0,2</b>          | mm |

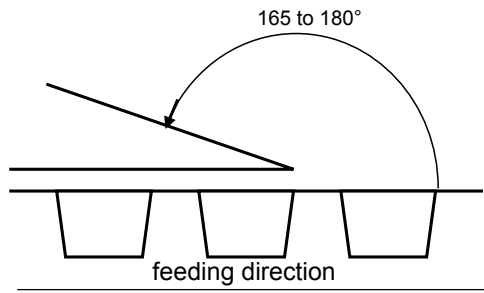

The force for tearing off cover tape is 10 to 130 grams in arrow direction

|                                     |                          |      |                         |              |
|-------------------------------------|--------------------------|------|-------------------------|--------------|
| Freigabe erteilt / general release: | Kunde / customer         |      |                         |              |
|                                     |                          |      |                         |              |
| Datum / date                        | Unterschrift / signature |      |                         |              |
|                                     | Würth Elektronik         |      |                         |              |
|                                     |                          | SSt  | Version 2               | 06-09-27     |
|                                     |                          | MST  | Version 1               | 04-10-11     |
| Geprüft / checked                   | Kontrolliert / approved  | Name | Änderung / modification | Datum / date |

This electronic component has been designed and developed for usage in general electronic equipment. Before incorporating this component into any equipment where higher safety and reliability is especially required or if there is the possibility of direct damage or injury to human body, for example in the range of aerospace, aviation, nuclear control, submarine, transportation, (automotive control, train control, ship control), transportation signal, disaster prevention, medical, public information network etc, Würth Elektronik eiSos GmbH must be informed before the design-in stage. In addition, sufficient reliability evaluation checks for safety must be performed on every electronic component which is used in electrical circuits that require high safety and reliability functions or performance.

### Würth Elektronik eiSos GmbH & Co. KG

D-74638 Waldenburg · Max-Eyth-Strasse 1 · Germany · Telefon (+49) (0) 7942 - 945 - 0 · Telefax (+49) (0) 7942 - 945 - 400  
<http://www.we-online.com>