

## PHASE CONTROL THYRISTORS

## Hockey Puk Version

### Features

- Center amplifying gate
- Metal case with ceramic insulator
- International standard case TO-200AB (A-PUK)

### Typical Applications

- DC motor controls
- Controlled DC power supplies
- AC controllers

### Major Ratings and Characteristics

Parameters	ST180C..C	Units
$I_{T(AV)}$	350	A
@ $T_{hs}$	55	°C
$I_{T(RMS)}$	660	A
@ $T_{hs}$	25	°C
$I_{TSM}$	@ 50Hz	5000
	@ 60Hz	5230
$I^2t$	@ 50Hz	125
	@ 60Hz	114
$V_{DRM}/V_{RRM}$	400 to 2000	V
$t_q$ typical	100	μs
$T_J$	- 40 to 125	°C

350A

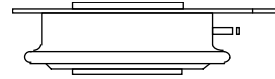

case style TO-200AB (A-PUK)

## ST180C..C Series

Bulletin I25164 rev. C 02/00

International  
**IRF** Rectifier

### ELECTRICAL SPECIFICATIONS

#### Voltage Ratings

Type number	Voltage Code	$V_{DRM}/V_{RRM}$ , max. repetitive peak and off-state voltage V	$V_{RSM}$ , maximum non-repetitive peak voltage V	$I_{DRM}/I_{RRM}$ max. @ $T_J = T_J$ max mA
ST180C..C	04	400	500	30
	08	800	900	
	12	1200	1300	
	16	1600	1700	
	18	1800	1900	
	20	2000	2100	

#### On-state Conduction

Parameter	ST180C..C	Units	Conditions	
$I_{T(AV)}$ Max. average on-state current @ Heatsink temperature	350 (140)	A	180° conduction, half sine wave double side (single side) cooled	
	55 (85)	°C		
$I_{T(RMS)}$ Max. RMS on-state current	660	A	@ 25°C heatsink temperature double side cooled	
$I_{TSM}$ Max. peak, one-cycle non-repetitive surge current	5000		t = 10ms	No voltage reappplied
	5230		t = 8.3ms	reappplied
	4200		t = 10ms	100% $V_{RRM}$
	4400	t = 8.3ms	reappplied	
$I^2t$ Maximum $I^2t$ for fusing	125	KA <sup>2</sup> s	t = 10ms	Sinusoidal half wave, Initial $T_J = T_J$ max.
	114		t = 8.3ms	
	88		t = 10ms	
	81		t = 8.3ms	
$I^2\sqrt{t}$ Maximum $I^2\sqrt{t}$ for fusing	1250	KA <sup>2</sup> /s	t = 0.1 to 10ms, no voltage reappplied	
$V_{T(TO)1}$ Low level value of threshold voltage	1.08	V	$(16.7\% \times \pi \times I_{T(AV)} < I < \pi \times I_{T(AV)})$ , $T_J = T_J$ max.	
$V_{T(TO)2}$ High level value of threshold voltage	1.14		$(I > \pi \times I_{T(AV)})$ , $T_J = T_J$ max.	
$r_{t1}$ Low level value of on-state slope resistance	1.18	mΩ	$(16.7\% \times \pi \times I_{T(AV)} < I < \pi \times I_{T(AV)})$ , $T_J = T_J$ max.	
$r_{t2}$ High level value of on-state slope resistance	1.14		$(I > \pi \times I_{T(AV)})$ , $T_J = T_J$ max.	
$V_{TM}$ Max. on-state voltage	1.96	V	$I_{pk} = 750A$ , $T_J = T_J$ max, $t_p = 10ms$ sine pulse	
$I_H$ Maximum holding current	600	mA	$T_J = T_J$ max, anode supply 12V resistive load	
$I_L$ Max. (typical) latching current	1000 (300)			

**Switching**

Parameter	ST180C..C	Units	Conditions
di/dt Max. non-repetitive rate of rise of turned-on current	1000	A/μs	Gate drive 20V, 20Ω, t <sub>r</sub> ≤ 1 μs T <sub>J</sub> = T <sub>J</sub> max, anode voltage ≤ 80% V <sub>DRM</sub>
t <sub>d</sub> Typical delay time	1.0	μs	Gate current 1A, di <sub>g</sub> /dt = 1A/μs V <sub>d</sub> = 0.67% V <sub>DRM</sub> , T <sub>J</sub> = 25°C
t <sub>q</sub> Typical turn-off time	100		I <sub>TM</sub> = 300A, T <sub>J</sub> = T <sub>J</sub> max, di/dt = 20A/μs, V <sub>R</sub> = 50V dv/dt = 20V/μs, Gate 0V 100Ω, t <sub>p</sub> = 500μs

**Blocking**

Parameter	ST180C..C	Units	Conditions
dv/dt Maximum critical rate of rise of off-state voltage	500	V/μs	T <sub>J</sub> = T <sub>J</sub> max linear to 80% rated V <sub>DRM</sub>
I <sub>DRM</sub> I <sub>RRM</sub> Max. peak reverse and off-state leakage current	30	mA	T <sub>J</sub> = T <sub>J</sub> max, rated V <sub>DRM</sub> /V <sub>RRM</sub> applied

**Triggering**

Parameter	ST180C..C		Units	Conditions
P <sub>GM</sub> Maximum peak gate power	10		W	T <sub>J</sub> = T <sub>J</sub> max, t <sub>p</sub> ≤ 5ms
P <sub>G(AV)</sub> Maximum average gate power	2.0			T <sub>J</sub> = T <sub>J</sub> max, f = 50Hz, d% = 50
I <sub>GM</sub> Max. peak positive gate current	3.0		A	T <sub>J</sub> = T <sub>J</sub> max, t <sub>p</sub> ≤ 5ms
+V <sub>GM</sub> Maximum peak positive gate voltage	20		V	T <sub>J</sub> = T <sub>J</sub> max, t <sub>p</sub> ≤ 5ms
-V <sub>GM</sub> Maximum peak negative gate voltage	5.0			
I <sub>GT</sub> DC gate current required to trigger	TYP.	MAX.	mA	T <sub>J</sub> = - 40°C T <sub>J</sub> = 25°C T <sub>J</sub> = 125°C  Max. required gate trigger/ current/ voltage are the lowest value which will trigger all units 12V anode-to-cathode applied
	180	-		
	90	150		
V <sub>GT</sub> DC gate voltage required to trigger	2.9	-	V	T <sub>J</sub> = - 40°C T <sub>J</sub> = 25°C T <sub>J</sub> = 125°C
	1.8	3.0		
	1.2	-		
I <sub>GD</sub> DC gate current not to trigger	10		mA	T <sub>J</sub> = T <sub>J</sub> max Max. gate current/voltage not to trigger is the max. value which will not trigger any unit with rated V <sub>DRM</sub> anode-to-cathode applied
V <sub>GD</sub> DC gate voltage not to trigger	0.25			

## ST180C..C Series

Bulletin I25164 rev. C 02/00

International  
**IRF** Rectifier

### Thermal and Mechanical Specification

Parameter	ST180C..C	Units	Conditions
T <sub>J</sub> Max. operating temperature range	-40 to 125	°C	
T <sub>stg</sub> Max. storage temperature range	-40 to 150		
R <sub>thJ-hs</sub> Max. thermal resistance, junction to heatsink	0.17 0.08	K/W	DC operation single side cooled DC operation double side cooled
R <sub>thC-hs</sub> Max. thermal resistance, case to heatsink	0.033 0.017		K/W
F Mounting force, ± 10%	4900 (500)	N (Kg)	
wt Approximate weight	50	g	
Case style	TO - 200AB (A-PUK)		See Outline Table

### $\Delta R_{thJ-hs}$ Conduction

(The following table shows the increment of thermal resistance R<sub>thJ-hs</sub> when devices operate at different conduction angles than DC)

Conduction angle	Sinusoidal conduction		Rectangular conduction		Units	Conditions
	Single Side	Double Side	Single Side	Double Side		
180°	0.015	0.015	0.011	0.011	K/W	T <sub>J</sub> = T <sub>J</sub> max.
120°	0.018	0.019	0.019	0.019		
90°	0.024	0.024	0.026	0.026		
60°	0.035	0.035	0.036	0.037		
30°	0.060	0.060	0.060	0.061		

### Ordering Information Table

Device Code							
<b>ST</b>	<b>18</b>	<b>0</b>	<b>C</b>	<b>20</b>	<b>C</b>	<b>1</b>	
(1)	(2)	(3)	(4)	(5)	(6)	(7)	(8)
<b>1</b>	- Thyristor	<b>2</b>	- Essential part number	<b>3</b>	- 0 = Converter grade	<b>4</b>	- C = Ceramic Puk
<b>5</b>	- Voltage code: Code x 100 = V <sub>RRM</sub> (See Voltage Rating Table)	<b>6</b>	- C = Puk Case TO-200AB (A-PUK)	<b>7</b>	- 0 = Eyelet terminals (Gate and Auxiliary Cathode Unsoldered Leads) 1 = Fast-on terminals (Gate and Auxiliary Cathode Unsoldered Leads) 2 = Eyelet terminals (Gate and Auxiliary Cathode Soldered Leads) 3 = Fast-on terminals (Gate and Auxiliary Cathode Soldered Leads)	<b>8</b>	- Critical dv/dt: None = 500V/μsec (Standard value) L = 1000V/μsec (Special selection)

Outline Table

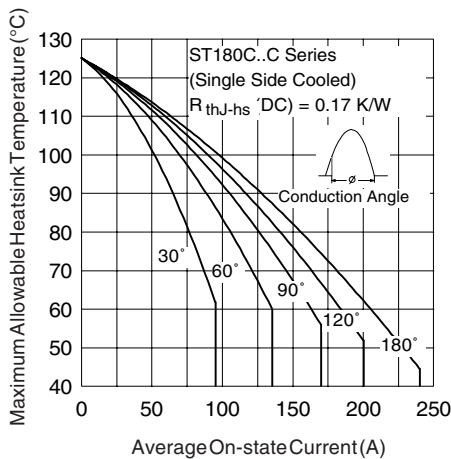
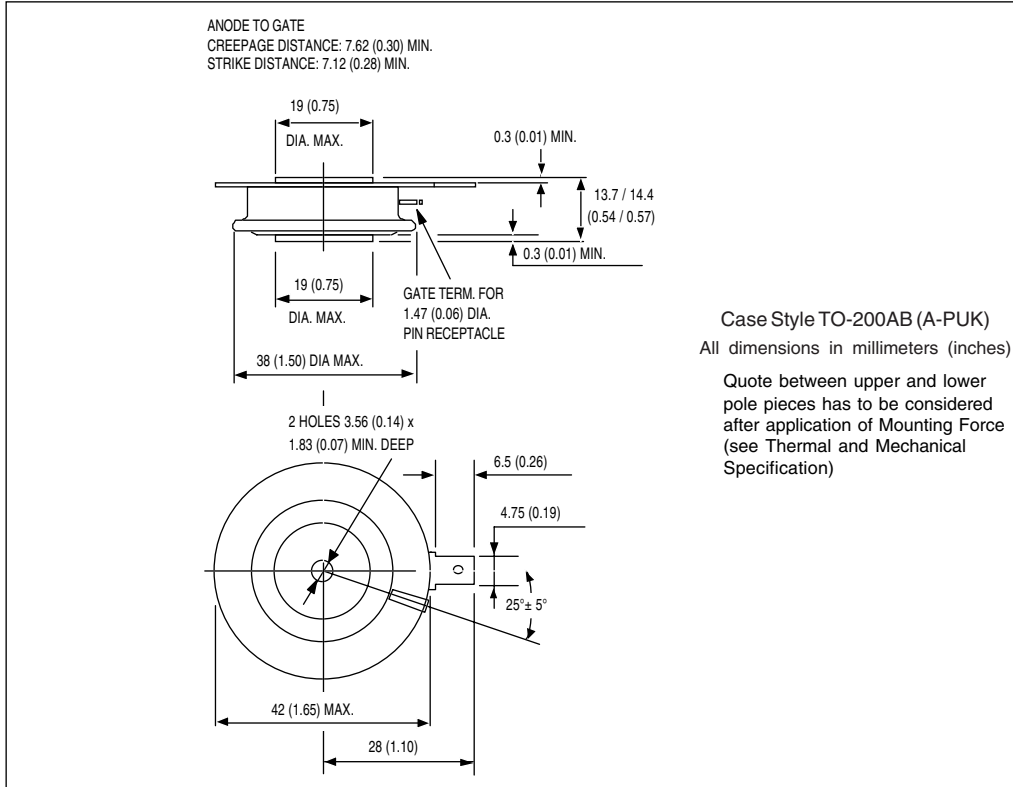

Fig. 1 - Current Ratings Characteristics

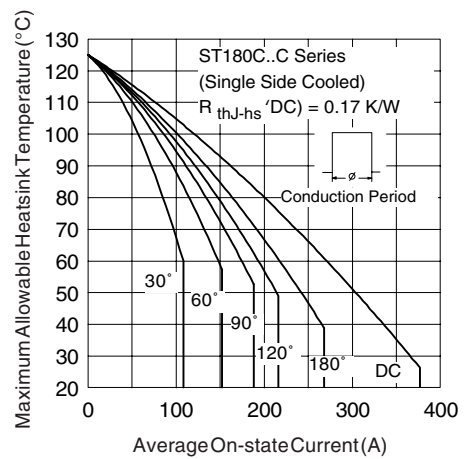

Fig. 2 - Current Ratings Characteristics

# ST180C..C Series

Bulletin I25164 rev. C 02/00

International  
**IRF** Rectifier

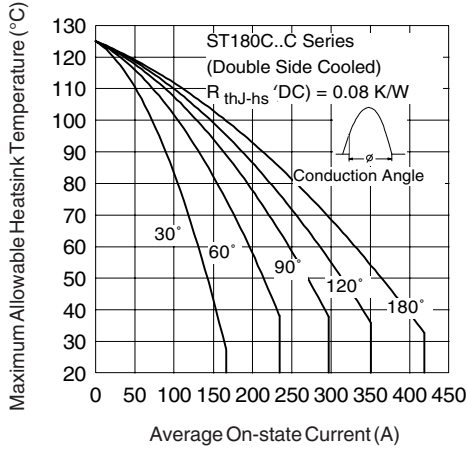

Fig. 3 - Current Ratings Characteristics

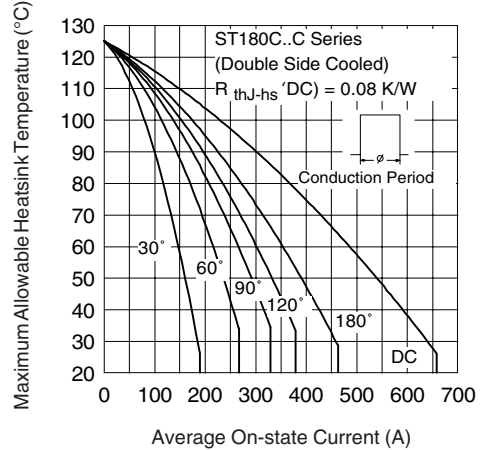

Fig. 4 - Current Ratings Characteristics

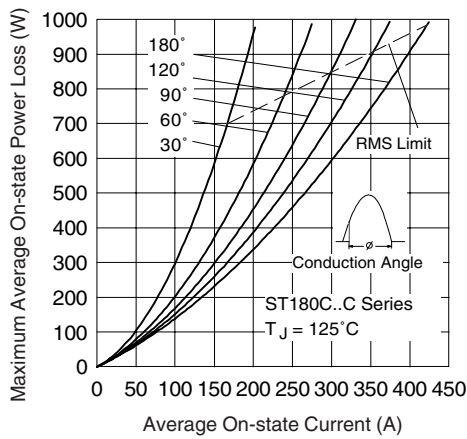

Fig. 5 - On-state Power Loss Characteristics

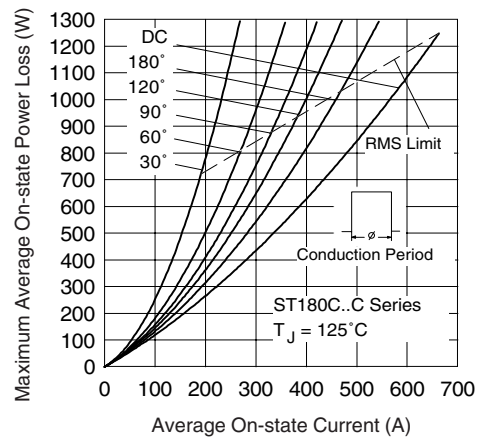

Fig. 6 - On-state Power Loss Characteristics

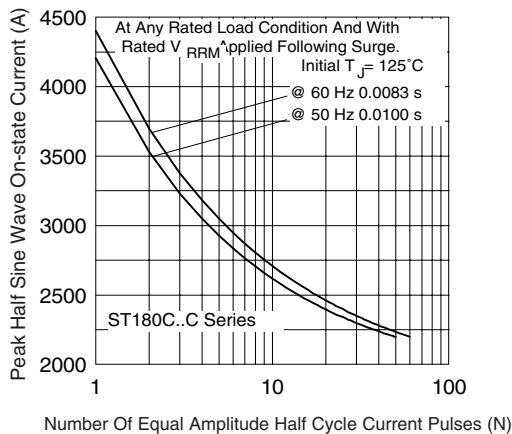

Fig. 7 - Maximum Non-Repetitive Surge Current Single and Double Side Cooled

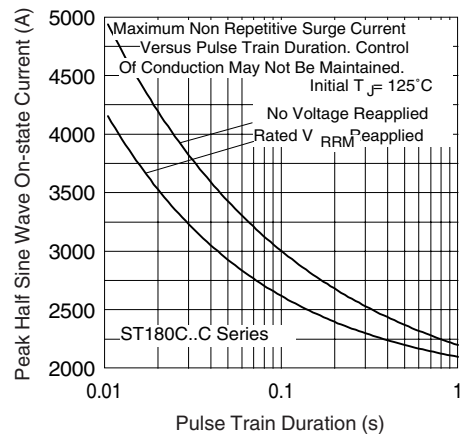

Fig. 8 - Maximum Non-Repetitive Surge Current Single and Double Side Cooled

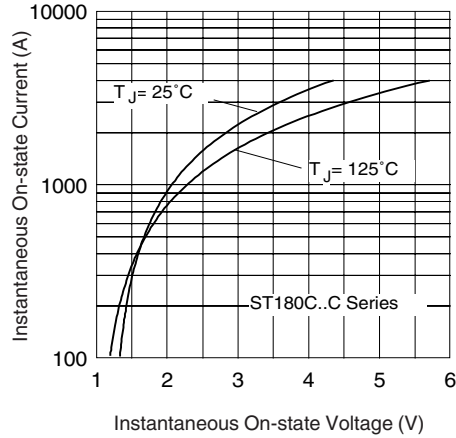

Fig. 9 - On-state Voltage Drop Characteristics

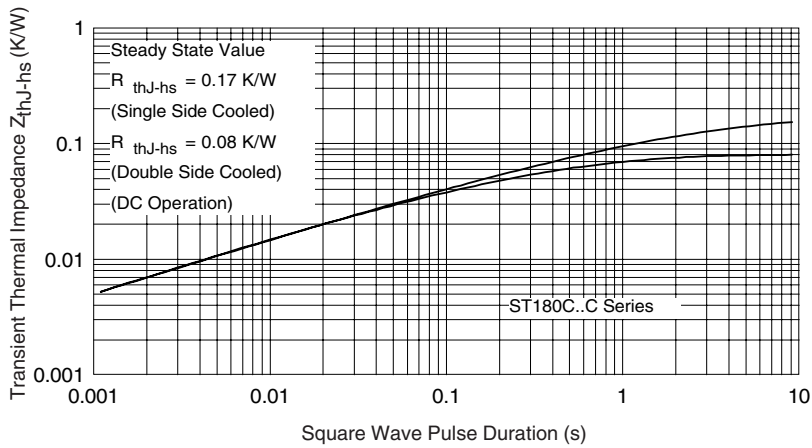

Fig. 10 - Thermal Impedance  $Z_{thJ-hs}$  Characteristics

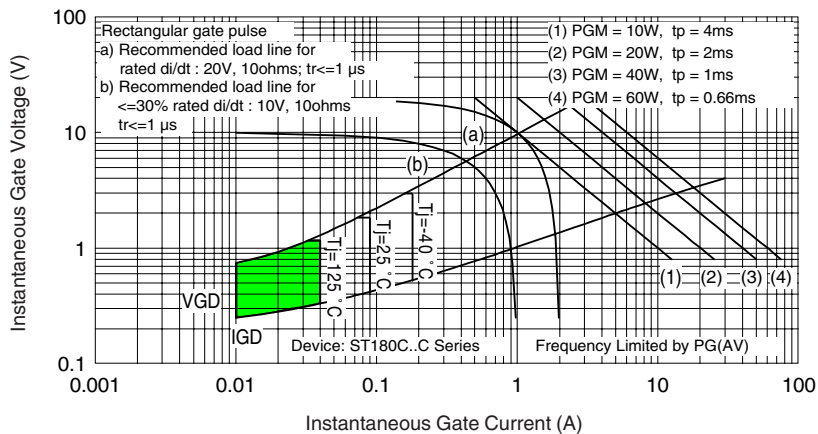

Fig. 11 - Gate Characteristics