

MMIC Silicon Bipolar Broadband Amplifier

The ISL55005, ISL55007, ISL55008 and ISL55009, ISL55010, ISL55011 constitute a family of high performance gain blocks featuring a Darlington configuration using high f_t transistors and excellent thermal performance. They are an ideal choice for DVB-S LNB cable receiver applications.

ISL55005, ISL55007, ISL55008 offer higher OIP3 performance while the ISL55009, ISL55010, ISL55011 offer lower operating supply currents.

ISL55005 and ISL55009 match a 75Ω source to a 50Ω load. ISL55007 and ISL55010 match a 75Ω source to a 75Ω load. ISL55008 and ISL55011 match a 50Ω source to a 50Ω load.

Ordering Information

PART NUMBER (Note)	PART MARKING	TAPE & REEL	PACKAGE (Pb-Free)	PKG. DWG. #
ISL55010IEZ-T7	CBG	7" (3k pcs)	6 Ld SC-70	P6.049

NOTE: Intersil Pb-free plus anneal products employ special Pb-free material sets; molding compounds/die attach materials and 100% matte tin plate termination finish, which are RoHS compliant and compatible with both SnPb and Pb-free soldering operations. Intersil Pb-free products are MSL classified at Pb-free peak reflow temperatures that meet or exceed the Pb-free requirements of IPC/JEDEC J STD-020.

Typical Application Circuit

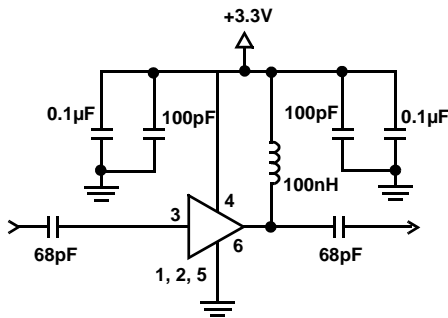

Features

- Input impedance of 75Ω
- Output impedance of 75Ω
- Noise figure of 3.7dB
- OIP3 of 11dBm
- Low supply current of 14mA
- Low input and output return losses
- Pb-free plus anneal available (RoHS compliant)

Applications

- LNB and LNB-T line amplifiers
- IF gain blocks for satellite and terrestrial HDTV STBs
- PA driver amplifier
- Wireless data, satellite
- Bluetooth/WiFi
- Satellite locator and signal strength meters

Pinout

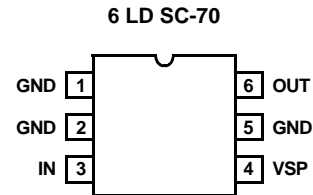

Typical Performance Curves $Z_{src} = 75\Omega$, $Z_{load} = 75\Omega$

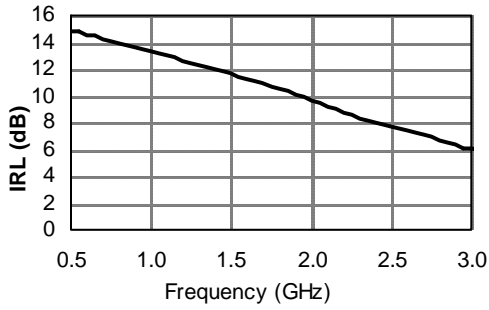

FIGURE 1. INPUT RETURN LOSS vs FREQUENCY

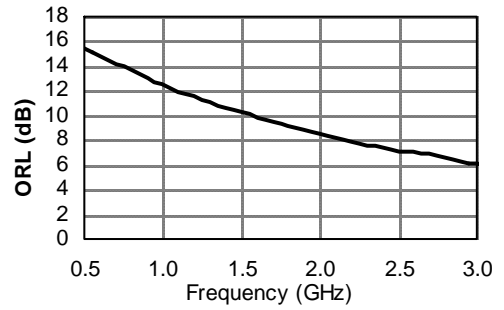

FIGURE 2. OUTPUT RETURN LOSS vs FREQUENCY

Typical Performance Curves 50Ω environment

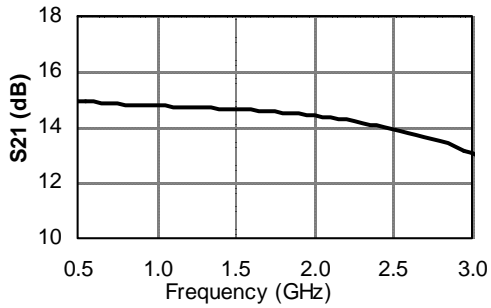

FIGURE 3. |S21| vs FREQUENCY

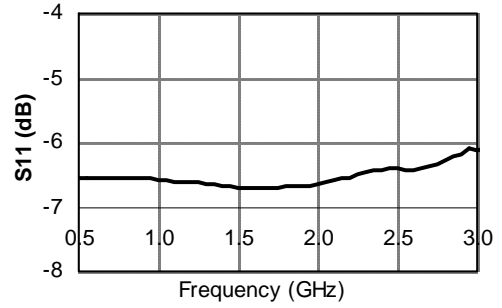

FIGURE 4. |S11| vs FREQUENCY

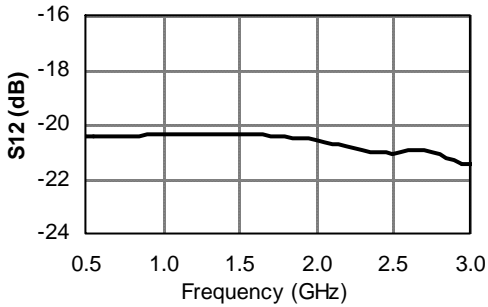

FIGURE 5. |S12| vs FREQUENCY

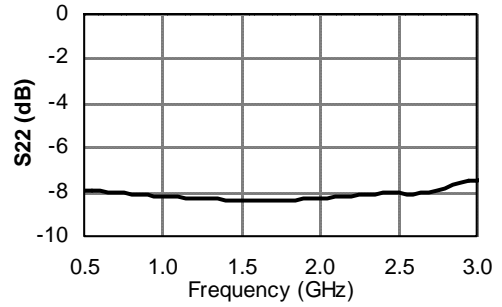

FIGURE 6. |S22| vs FREQUENCY

Typical Performance Curves 50Ω environment (Continued)

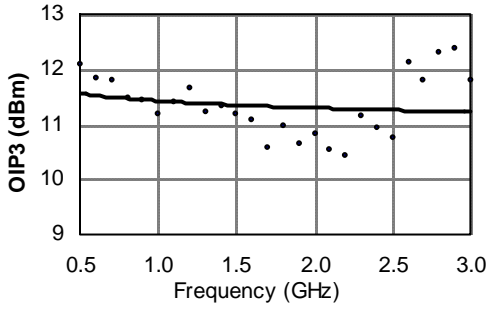

FIGURE 7. OIP3 vs FREQUENCY

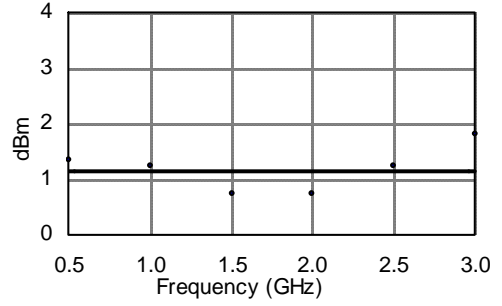

FIGURE 8. P1dBm vs FREQUENCY

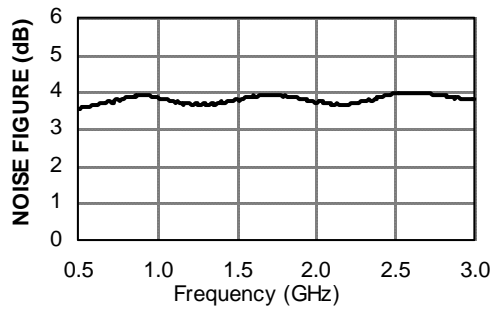

FIGURE 9. NOISE FIGURE vs FREQUENCY

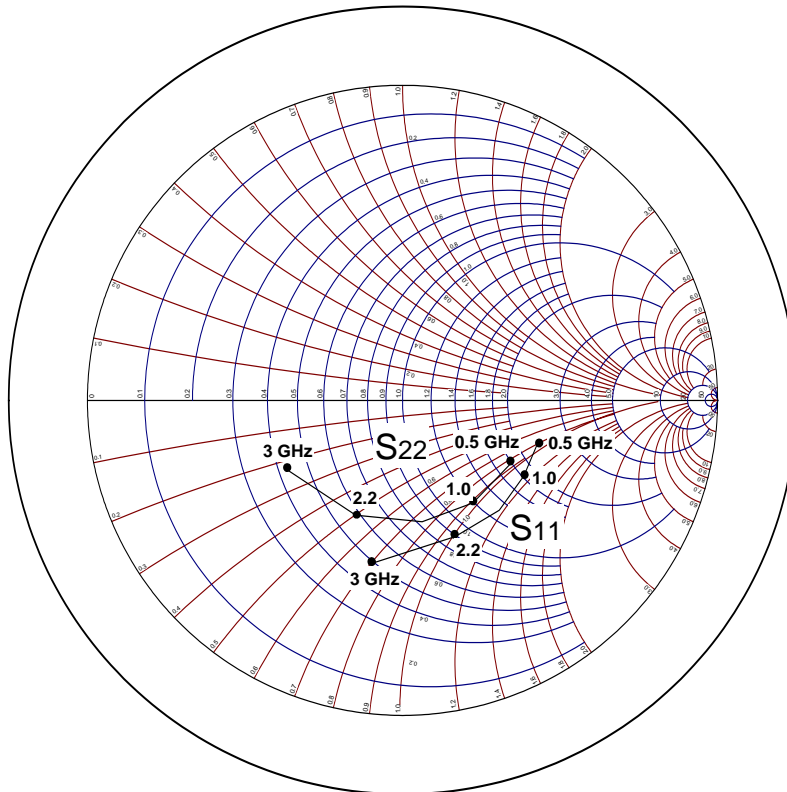

FIGURE 10. S11 AND S22 vs FREQUENCY

Packaging Information

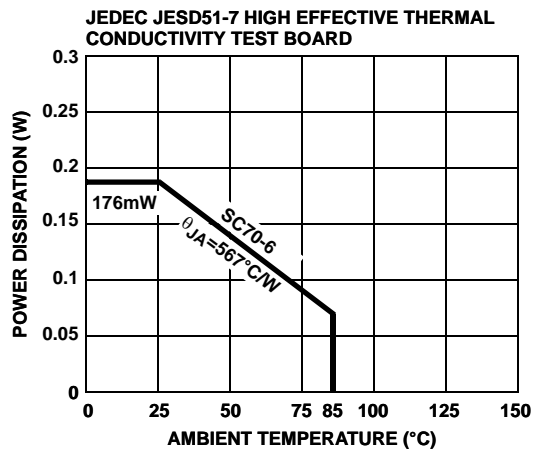
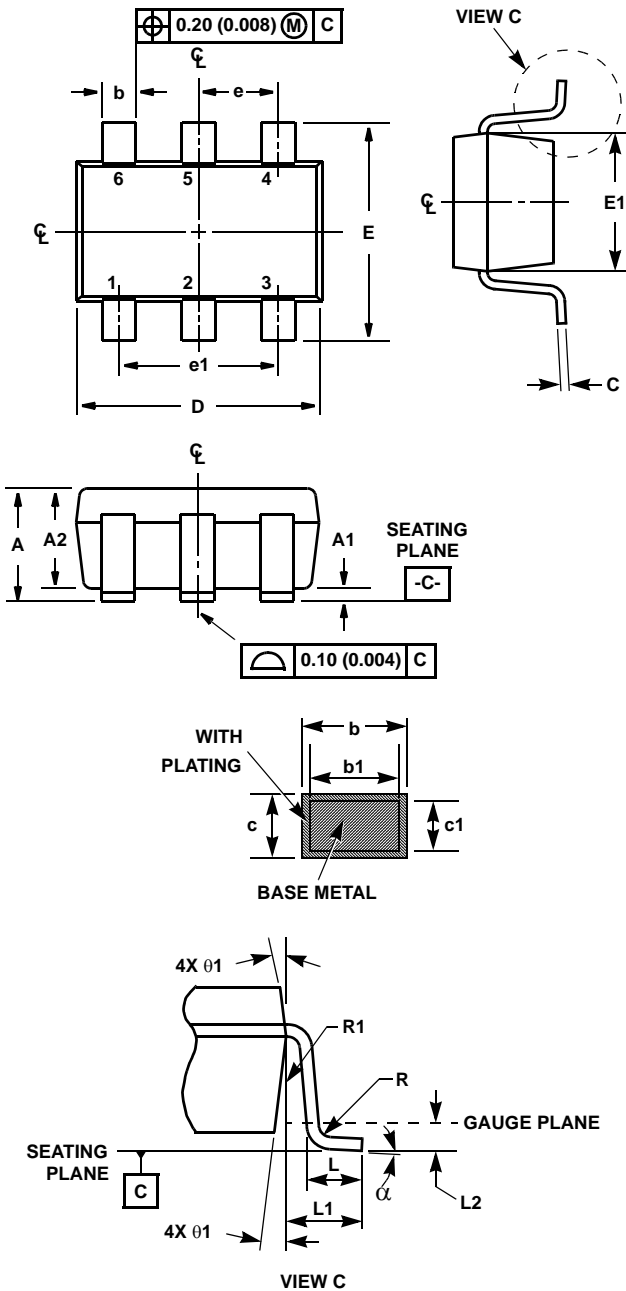

FIGURE 11. PACKAGE POWER DISSIPATION vs AMBIENT TEMPERATURE

Small Outline Transistor Plastic Packages (SC70-6)



P6.049

6 LEAD SMALL OUTLINE TRANSISTOR PLASTIC PACKAGE

SYMBOL	INCHES		MILLIMETERS		NOTES
	MIN	MAX	MIN	MAX	
A	0.031	0.043	0.80	1.10	-
A1	0.000	0.004	0.00	0.10	-
A2	0.031	0.039	0.00	1.00	-
b	0.006	0.012	0.15	0.30	-
b1	0.006	0.010	0.15	0.25	-
c	0.003	0.009	0.08	0.22	6
c1	0.003	0.009	0.08	0.20	6
D	0.073	0.085	1.85	2.15	3
E	0.071	0.094	1.80	2.40	-
E1	0.045	0.053	1.15	1.35	3
e	0.0256 Ref		0.65 Ref		-
e1	0.0512 Ref		1.30 Ref		-
L	0.010	0.018	0.26	0.46	4
L1	0.017 Ref.		0.420 Ref.		-
L2	0.006 BSC		0.15 BSC		-
N	6		6		5
R	0.004	-	0.10	-	-
R1	0.004	0.010	0.15	0.25	-
α	0°	8°	0°	8°	-

Rev. 2 9/03

NOTES:

1. Dimensioning and tolerance per ASME Y14.5M-1994.
2. Package conforms to EIAJ SC70 and JEDEC MO203AB.
3. Dimensions D and E1 are exclusive of mold flash, protrusions, or gate burrs.
4. Footlength L measured at reference to gauge plane.
5. "N" is the number of terminal positions.
6. These Dimensions apply to the flat section of the lead between 0.08mm and 0.15mm from the lead tip.
7. Controlling dimension: MILLIMETER. Converted inch dimensions are for reference only

All Intersil U.S. products are manufactured, assembled and tested utilizing ISO9000 quality systems.

Intersil Corporation's quality certifications can be viewed at www.intersil.com/design/quality

Intersil products are sold by description only. Intersil Corporation reserves the right to make changes in circuit design, software and/or specifications at any time without notice. Accordingly, the reader is cautioned to verify that data sheets are current before placing orders. Information furnished by Intersil is believed to be accurate and reliable. However, no responsibility is assumed by Intersil or its subsidiaries for its use; nor for any infringements of patents or other rights of third parties which may result from its use. No license is granted by implication or otherwise under any patent or patent rights of Intersil or its subsidiaries.

For information regarding Intersil Corporation and its products, see www.intersil.com