

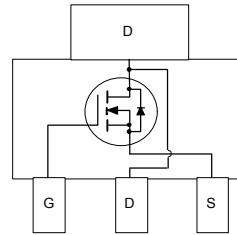
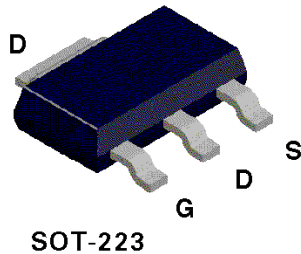
## NDT451AN N-Channel Enhancement Mode Field Effect Transistor

### General Description

Power SOT N-Channel enhancement mode power field effect transistors are produced using Fairchild's proprietary, high cell density, DMOS technology. This very high density process is especially tailored to minimize on-state resistance and provide superior switching performance. These devices are particularly suited for low voltage applications such as DC motor control and DC/DC conversion where fast switching, low in-line power loss, and resistance to transients are needed.

### Features

- 7.2A, 30V.  $R_{DS(ON)} = 0.035\Omega @ V_{GS} = 10V$   
 $R_{DS(ON)} = 0.05\Omega @ V_{GS} = 4.5V.$
- High density cell design for extremely low  $R_{DS(ON)}$ .
- High power and current handling capability in a widely used surface mount package.



### Absolute Maximum Ratings $T_A = 25^\circ\text{C}$ unless otherwise noted

Symbol	Parameter	NDT451AN	Units
$V_{DSS}$	Drain-Source Voltage	30	V
$V_{GSS}$	Gate-Source Voltage	$\pm 20$	V
$I_D$	Drain Current - Continuous (Note 1a)	$\pm 7.2$	A
	- Pulsed	$\pm 25$	
$P_D$	Maximum Power Dissipation (Note 1a)	3	W
		1.3 (Note 1b)	
		1.1 (Note 1c)	
$T_J, T_{STG}$	Operating and Storage Temperature Range	-65 to 150	$^\circ\text{C}$

### THERMAL CHARACTERISTICS

$R_{\theta JA}$	Thermal Resistance, Junction-to-Ambient (Note 1a)	42	$^\circ\text{C/W}$
$R_{\theta JC}$	Thermal Resistance, Junction-to-Case (Note 1)	12	$^\circ\text{C/W}$

**Electrical Characteristics** ( $T_A = 25^\circ\text{C}$  unless otherwise noted)

Symbol	Parameter	Conditions	Min	Typ	Max	Units	
<b>OFF CHARACTERISTICS</b>							
$BV_{DSS}$	Drain-Source Breakdown Voltage	$V_{GS} = 0\text{ V}, I_D = 250\ \mu\text{A}$	30			V	
$I_{DSS}$	Zero Gate Voltage Drain Current	$V_{DS} = 24\text{ V}, V_{GS} = 0\text{ V}$			1	$\mu\text{A}$	
			$T_J = 55^\circ\text{C}$		10	$\mu\text{A}$	
$I_{GSSF}$	Gate - Body Leakage, Forward	$V_{GS} = 20\text{ V}, V_{DS} = 0\text{ V}$			100	nA	
$I_{GSSR}$	Gate - Body Leakage, Reverse	$V_{GS} = -20\text{ V}, V_{DS} = 0\text{ V}$			-100	nA	
<b>ON CHARACTERISTICS</b> (Note 2)							
$V_{GS(th)}$	Gate Threshold Voltage	$V_{DS} = V_{GS}, I_D = 250\ \mu\text{A}$	1	1.6	3	V	
			$T_J = 125^\circ\text{C}$	0.7	1.2		2.2
$R_{DS(on)}$	Static Drain-Source On-Resistance	$V_{GS} = 10\text{ V}, I_D = 7.2\text{ A}$		0.03	0.035	$\Omega$	
			$T_J = 125^\circ\text{C}$		0.042		0.063
			$V_{GS} = 4.5\text{ V}, I_D = 6.0\text{ A}$		0.042		0.05
$I_{D(on)}$	On-State Drain Current	$V_{GS} = 10\text{ V}, V_{DS} = 5\text{ V}$	25			A	
			$V_{GS} = 4.5\text{ V}, V_{DS} = 5\text{ V}$	15			
$g_{FS}$	Forward Transconductance	$V_{DS} = 10\text{ V}, I_D = 7.2\text{ A}$		11		S	
<b>DYNAMIC CHARACTERISTICS</b>							
$C_{iss}$	Input Capacitance	$V_{DS} = 15\text{ V}, V_{GS} = 0\text{ V},$ $f = 1.0\text{ MHz}$		720		pF	
$C_{oss}$	Output Capacitance			370		pF	
$C_{rss}$	Reverse Transfer Capacitance			250		pF	
<b>SWITCHING CHARACTERISTICS</b> (Note 2)							
$t_{D(on)}$	Turn - On Delay Time	$V_{DD} = 10\text{ V}, I_D = 1\text{ A},$ $V_{GEN} = 10\text{ V}, R_{GEN} = 6\ \Omega$		12	20	ns	
$t_r$	Turn - On Rise Time			13	30	ns	
$t_{D(off)}$	Turn - Off Delay Time			29	50	ns	
$t_f$	Turn - Off Fall Time			10	20	ns	
$Q_g$	Total Gate Charge	$V_{DS} = 10\text{ V},$ $I_D = 7.2\text{ A}, V_{GS} = 10\text{ V}$		19	30	nC	
$Q_{gs}$	Gate-Source Charge			2.3		nC	
$Q_{gd}$	Gate-Drain Charge			5.5		nC	

**Electrical Characteristics** ( $T_A = 25^\circ\text{C}$  unless otherwise noted)

Symbol	Parameter	Conditions	Min	Typ	Max	Units
<b>DRAIN-SOURCE DIODE CHARACTERISTICS AND MAXIMUM RATINGS</b>						
$I_S$	Maximum Continuous Drain-Source Diode Forward Current				2.3	A
$V_{SD}$	Drain-Source Diode Forward Voltage	$V_{GS} = 0\text{ V}$ , $I_S = 7.2\text{ A}$ (Note 2)		0.9	1.3	V
$t_{rr}$	Reverse Recovery Time	$V_{GS} = 0\text{ V}$ , $I_F = 1.25\text{ A}$ , $dI_F/dt = 100\text{ A}/\mu\text{s}$			100	ns

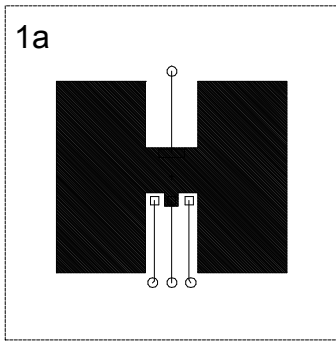
Notes:

- $R_{\theta JA}$  is the sum of the junction-to-case and case-to-ambient thermal resistance where the case thermal reference is defined as the solder mounting surface of the drain pins.  $R_{\theta JC}$  is guaranteed by design while  $R_{\theta CA}$  is determined by the user's board design.

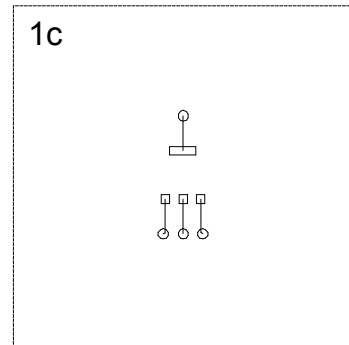
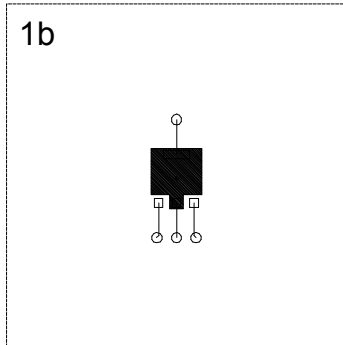
$$P_D(t) = \frac{T_J - T_A}{R_{\theta J A}(t)} = \frac{T_J - T_A}{R_{\theta J C} + R_{\theta CA}(t)} = I_D^2(t) \times R_{DS(on)} @ T_J$$

Typical  $R_{\theta JA}$  using the board layouts shown below on 4.5"x5" FR-4 PCB in a still air environment:

- 42°C/W when mounted on a 1 in<sup>2</sup> pad of 2oz copper.
- 95°C/W when mounted on a 0.066 in<sup>2</sup> pad of 2oz copper.
- 110°C/W when mounted on a 0.0123 in<sup>2</sup> pad of 2oz copper.



Scale 1 : 1 on letter size paper



- Pulse Test: Pulse Width  $\leq 300\mu\text{s}$ , Duty Cycle  $\leq 2.0\%$ .

## Typical Electrical Characteristics

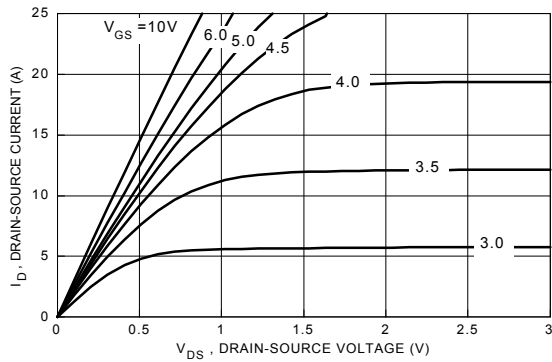


Figure 1. On-Region Characteristics.

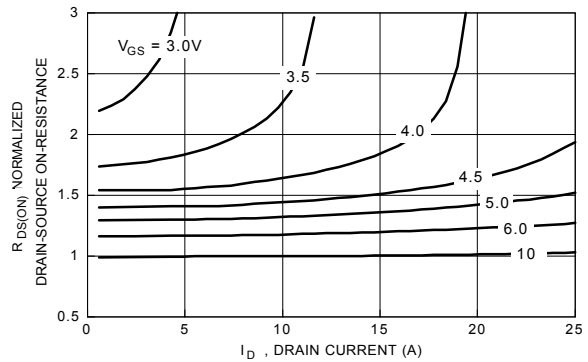


Figure 2. On-Resistance Variation with Gate Voltage and Drain Current.

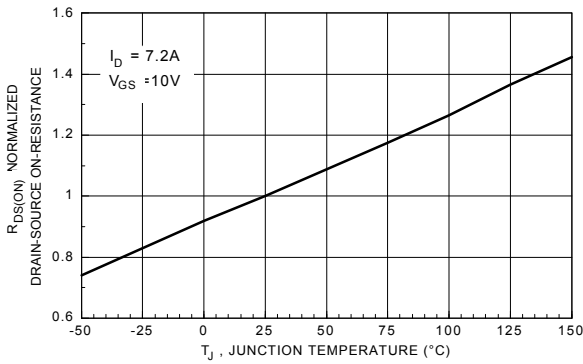


Figure 3. On-Resistance Variation with Temperature.

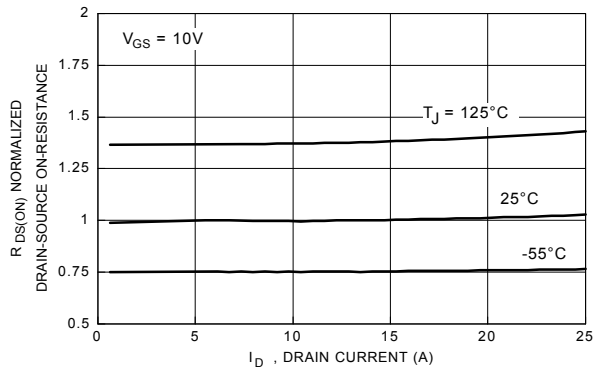


Figure 4. On-Resistance Variation with Drain Current and Temperature.

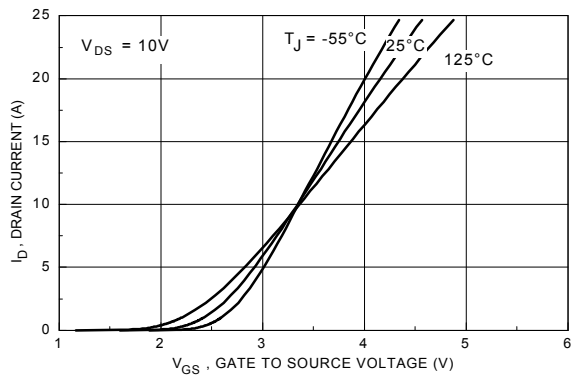


Figure 5. Transfer Characteristics.

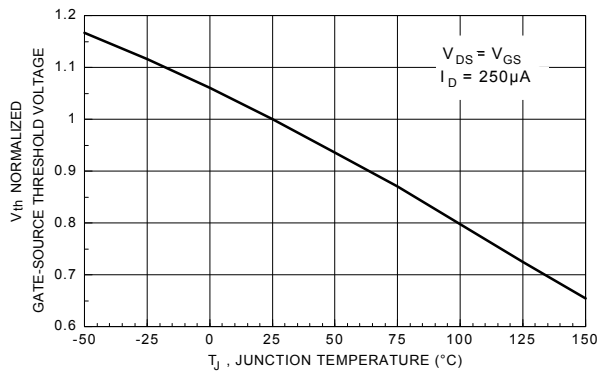
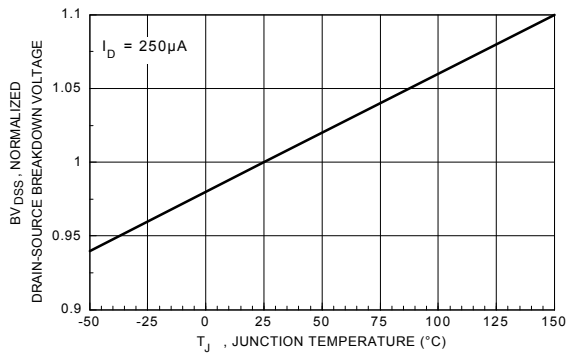
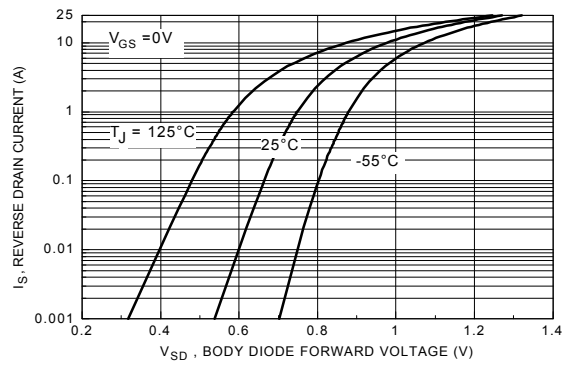


Figure 6. Gate Threshold Variation with Temperature.

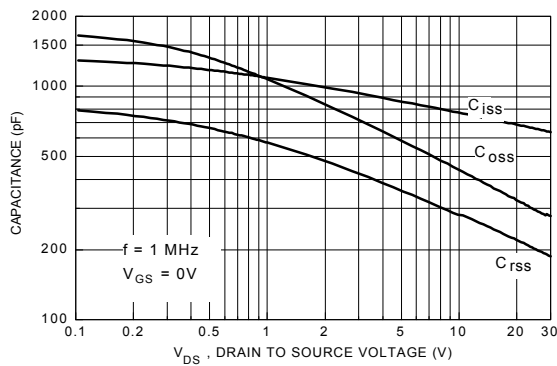
## Typical Electrical Characteristics



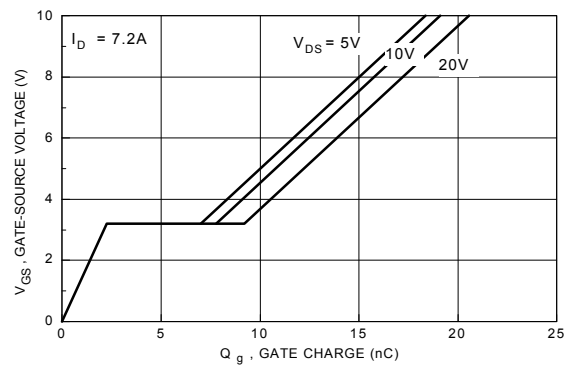
**Figure 7. Breakdown Voltage Variation with Temperature.**



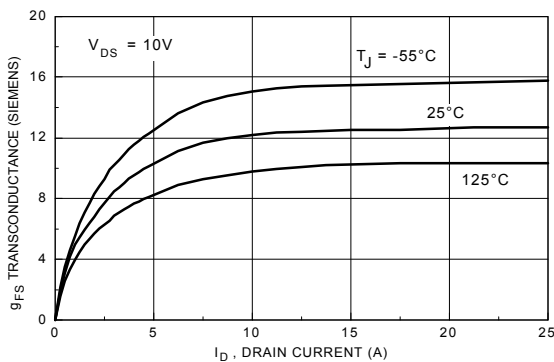
**Figure 8. Body Diode Forward Voltage Variation with Current and Temperature.**



**Figure 9. Capacitance Characteristics.**

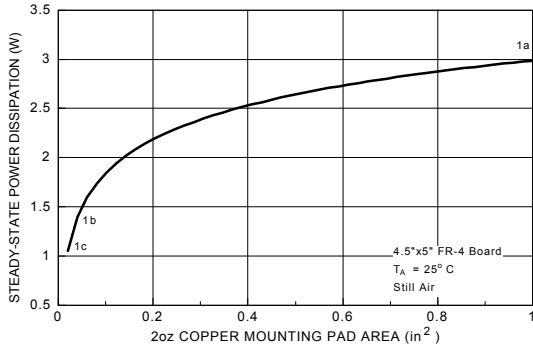


**Figure 10. Gate Charge Characteristics.**

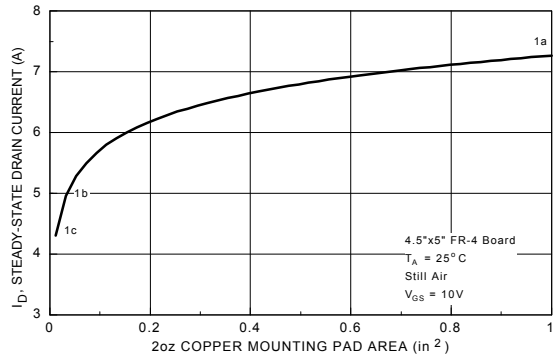


**Figure 11. Transconductance Variation with Drain Current and Temperature.**

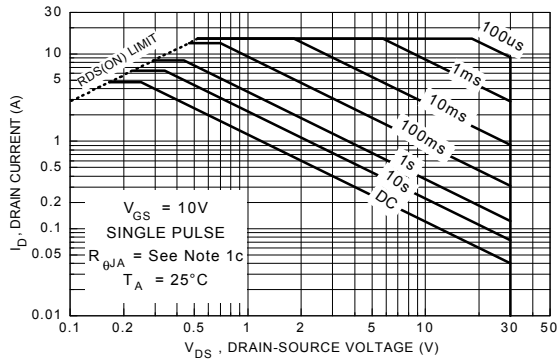
## Typical Thermal Characteristics



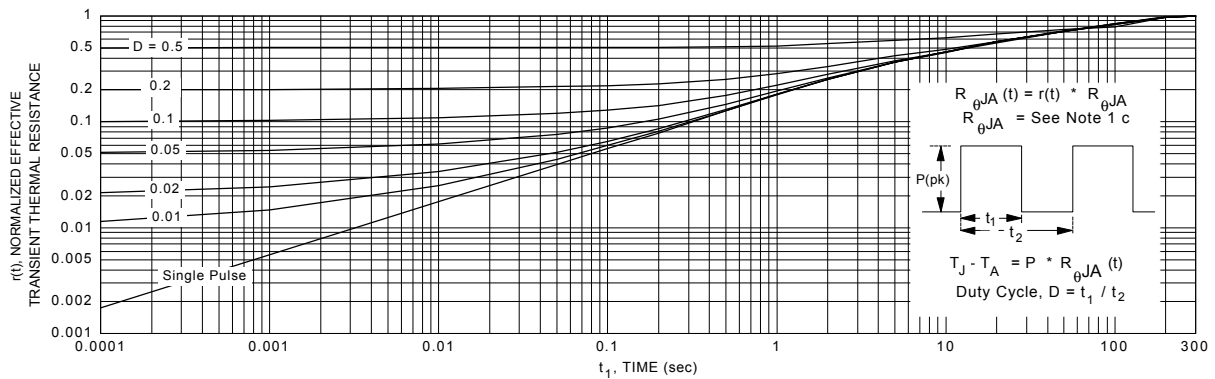
**Figure 12. SOT-223 Maximum Steady-State Power Dissipation versus Copper Mounting Pad Area.**



**Figure 13. Maximum Steady-State Drain Current versus Copper Mounting Pad Area.**



**Figure 14. Maximum Safe Operating Area.**








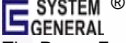
**Figure 15. Transient Thermal Response Curve.**

Note: Thermal characterization performed using the conditions described in note 1c. Transient thermal response will change depending on the circuit board design.



**TRADEMARKS**

The following includes registered and unregistered trademarks and service marks, owned by Fairchild Semiconductor and/or its global subsidiaries, and is not intended to be an exhaustive list of all such trademarks.

- |   |  |   |   |
|---|--|---|---|
| Build it Now™   | FRFET®   | Programmable Active Droop™  | the power franchise   |
| CorePLUS™   | Global Power Resource <sup>SM</sup>  | QFET®   | TinyBoost™  |
| CorePOWER™  | Green FPS™   | QS™   | TinyBuck™   |
| CROSSVOLT™  | Green FPS™ e-Series™   | Quiet Series™   | TinyLogic®  |
| CTL™  | GTO™   | RapidConfigure™   | TINYOPTO™   |
| Current Transfer Logic™   | IntelliMAX™  |  Saving our world, 1mW /W /kW at a time™ | TinyPower™  |
| EcoSPARK®   | ISOPLANAR™   | SmartMax™   | TinyPWM™  |
| EfficientMax™   | MegaBuck™  | SMART START™  | TinyWire™   |
| EZSWITCH™ *   | MICROCOUPLER™  | SPM®  | TriFault Detect™  |
|  ™ | MicroFET™  | STEALTH™  | μSerDes™  |
|  ™ | MicroPak™  | SuperFET™   |  SerDes™ |
| Fairchild®  | MillerDrive™   | SuperSOT™-3   | UHC®  |
| Fairchild Semiconductor®  | MotionMax™   | SuperSOT™-6   | Ultra FRFET™  |
| FACT Quiet Series™  | Motion-SPM™  | SuperSOT™-8   | UniFET™   |
| FACT®   | OPTOLOGIC®   | SupreMOS™   | VCX™  |
| FAST®   | OPTOPLANAR®  | SyncFET™  | VisualMax™  |
| FastvCore™  |  PDP SPM™ |  SYSTEM GENERAL®                         | XS™   |
| FlashWriter® *  | Power-SPM™   | The Power Franchise®  |   |
| FPS™  | PowerTrench®   |   |   |
| F-PFS™  | PowerXS™   |   |   |

\* EZSWITCH™ and FlashWriter® are trademarks of System General Corporation, used under license by Fairchild Semiconductor.

**DISCLAIMER**

FAIRCHILD SEMICONDUCTOR RESERVES THE RIGHT TO MAKE CHANGES WITHOUT FURTHER NOTICE TO ANY PRODUCTS HEREIN TO IMPROVE RELIABILITY, FUNCTION, OR DESIGN. FAIRCHILD DOES NOT ASSUME ANY LIABILITY ARISING OUT OF THE APPLICATION OR USE OF ANY PRODUCT OR CIRCUIT DESCRIBED HEREIN; NEITHER DOES IT CONVEY ANY LICENSE UNDER ITS PATENT RIGHTS, NOR THE RIGHTS OF OTHERS. THESE SPECIFICATIONS DO NOT EXPAND THE TERMS OF FAIRCHILD'S WORLDWIDE TERMS AND CONDITIONS, SPECIFICALLY THE WARRANTY THEREIN, WHICH COVERS THESE PRODUCTS.

**LIFE SUPPORT POLICY**

FAIRCHILD'S PRODUCTS ARE NOT AUTHORIZED FOR USE AS CRITICAL COMPONENTS IN LIFE SUPPORT DEVICES OR SYSTEMS WITHOUT THE EXPRESS WRITTEN APPROVAL OF FAIRCHILD SEMICONDUCTOR CORPORATION.

As used herein:

- Life support devices or systems are devices or systems which, (a) are intended for surgical implant into the body or (b) support or sustain life, and (c) whose failure to perform when properly used in accordance with instructions for use provided in the labeling, can be reasonably expected to result in a significant injury of the user.
- A critical component in any component of a life support, device, or system whose failure to perform can be reasonably expected to cause the failure of the life support device or system, or to affect its safety or effectiveness.

**ANTI-COUNTERFEITING POLICY**

Fairchild Semiconductor Corporation's Anti-Counterfeiting Policy. Fairchild's Anti-Counterfeiting Policy is also stated on our external website, www.Fairchildsemi.com, under Sales Support.

Counterfeiting of semiconductor parts is a growing problem in the industry. All manufactures of semiconductor products are experiencing counterfeiting of their parts. Customers who inadvertently purchase counterfeit parts experience many problems such as loss of brand reputation, substandard performance, failed application, and increased cost of production and manufacturing delays. Fairchild is taking strong measures to protect ourselves and our customers from the proliferation of counterfeit parts. Fairchild strongly encourages customers to purchase Fairchild parts either directly from Fairchild or from Authorized Fairchild Distributors who are listed by country on our web page cited above. Products customers buy either from fairchild directly or from Authorized Fairchild Distributors are genuine parts, have full traceability, meet Fairchild's quality standards for handling and storage and provide access to Fairchild's full range of up-to-date technical and product information. Fairchild and our Authorized Distributors will stand behind all warranties and will appropriately address and warranty issues that may arise. Fairchild will not provide any warranty coverage or other assistance for parts bought from Unauthorized Sources. Fairchild is committed to combat this global problem and encourage our customers to do their part in stopping this practice by buying direct or from authorized distributors.

**PRODUCT STATUS DEFINITIONS**

**Definition of Terms**

Datasheet Identification	Product Status	Definition
Advance Information	Formative / In Design	Datasheet contains the design specifications for product development. Specifications may change in any manner without notice.
Preliminary	First Production	Datasheet contains preliminary data; supplementary data will be published at a later date. Fairchild Semiconductor reserves the right to make changes at any time without notice to improve design.
No Identification Needed	Full Production	Datasheet contains final specifications. Fairchild Semiconductor reserves the right to make changes at any time without notice to improve the design.
Obsolete	Not In Production	Datasheet contains specifications on a product that is discontinued by Fairchild Semiconductor. The datasheet is for reference information only.