

AVX Periodic Tables

Version 10.1



**The Latest CV Tables from the Leader
in Capacitor Technology**

COMMERCIAL PRODUCTS

Product Line Card	3-4
-------------------------	-----

CERAMIC CAPACITORS

NPO Dielectric Standard MLCC	5
X7R Dielectric Standard MLCC	6
X7R Dielectric FLEXITERM®, For Board Flexure Applications	7
X7S Dielectric Standard MLCC	8
X5R Dielectric Standard MLCC	9
X5R/X7R Dielectric, Low Profile Capacitors	10
Y5V Dielectric Standard MLCC	11
High Voltage SMD MLCC RoHS	12
High Voltage FLEXITERM®	13
UltraThin Ceramic Capacitors	14
Tip & Ring	15

TIN/LEAD TERMINATIONS

NPO Dielectric LD Series, Tin/Lead Terminations	16
X7R Dielectric LD Series, Tin/Lead Terminations	17
X5R Dielectric LD Series, Tin/Lead Terminations	18
NPO Dielectric APS Series for COTS-Plus	19
X7R Dielectric APS Series for COTS-Plus	20
High Voltage SMD MLCC Tin/Lead	21
Tip & Ring Tin/Lead Termination "B"	22

AUTOMOTIVE SERIES CERAMIC CAPACITORS

NPO Dielectric Automotive Series	23
X7R Dielectric Automotive Series	24
X7R Dielectric FLEXITERM®, Automotive Series, For Board Flexure Applications	25
X7R AEC-Q200 High Voltage FLEXITERM®	26
Capacitor Arrays Standard MLCC	27
X7R FLEXISAFE™, For Ultra Safety Critical Applications	28
Automotive Series Capacitor Arrays	29

SWITCH MODE POWER SUPPLY CAPACITORS

TurboCap™ High-CV SMP Capacitors	30
MH Series Lead Free Ceramic Capacitor in Molded SM Leadframe	31
SK Series Leaded Capacitors for SMPS Output Filtering	32
SE Series of High Capacitance Leaded Capacitors for SMPS	33
RH Series for Commercial High Frequency DC-DC Converters	34
SMPS Stacked MLC Capacitors SM Style Surface Mount and Thru-Hole Styles (SM0, SM5)	35
SMPS Stacked MLC Capacitors RM Style Surface Mount and Thru-Hole Styles (RM0, RM5)	36
SMPS Stacked MLC Capacitors SM9 Style Encapsulated in DAP (Diallyl Phthalate) Case	37

DECOUPLING/LOW INDUCTANCE CAPACITORS

Low Inductance RoHS – Reverse Geometry/Decoupling Chips	38
Low Inductance Tin/Lead – Reverse Geometry/Decoupling Chips	39
IDC RoHS – Interdigitated Capacitors	40
IDC Tin/Lead – Interdigitated Capacitors	41
LGA – Land Grid Array Capacitors	42
LICA – Low Inductance Decoupling Capacitor Arrays	43

TANTALUM SURFACE MOUNT

TAJ Standard Tantalum Capacitors	44
TAJ LP Low Profile Tantalum Capacitors	45
TACmicrochip® Small Case Size Tantalum Capacitors	46
TAC LP Low Profile, Small Case Size Tantalum Capacitors	47
TLC Consumer Series Small Case Size Tantalum Capacitors	48
TLJ High CV Consumer Series	49
TLN Tantalum Solid Electrolytic Chip Capacitors Undertab Series	50
TPS Low ESR Tantalum Capacitors	51
TPM Ultra Low ESR Tantalum Capacitors	52
TPC Low ESR Small Case Size Tantalum Capacitors	53
TCJ Polymer Electrode Tantalum Capacitors	54
TCM Tantalum Solid Electrolytic Chip Capacitors Conductive Polymer Multianode	55
TCN Tantalum Solid Electrolytic Chip Capacitors Undertab Series with Conductive Polymer Electrode	56
TRJ Professional Series Tantalum Capacitors	57
TAW Tantalum Solid Electrolytic Fused Capacitors	58

HIGH TEMPERATURE

SMX	59
SXP	60
THJ High Temperature Series Tantalum Capacitors	61
THJ High Temperature Series Tantalum Chip Capacitors with Extension to 200°C	62
X8R Dielectric Standard MLCC	63
X8R Dielectric Automotive Series	64
X8R Dielectric FLEXITERM®, Automotive Series	65
X8R Dielectric LD Series, Tin/Lead Terminations	66

OXICAP® SURFACE MOUNT NIOBIUM OXIDE

NOJ OxiCap® Niobium Oxide Capacitors Standard	67
NOJ LP Low Profile Niobium Oxide Capacitors	68
NLJ Niobium Oxide Capacitors High CV Consumer Series	69
NOS Low ESR Niobium Oxide Capacitors	70
NOM Ultra Low ESR Niobium Oxide Capacitors	71

RF / MICROWAVE SURFACE MOUNT

Accu-F Thin Film Low ESR, High Q Capacitors	72
Accu-P Thin Film Low ESR, High Q Capacitors	73
SQCA/CB (0505/1111) Ceramic Low ESR, High Q Capacitors	74-75
SQCS/CF (0603/0805) Ceramic Low ESR, High Q Capacitors	76
U Series NPO Dielectric RoHS Low ESR Capacitors	77
U Series NPO Dielectric Tin/Lead Termination Low ESR Capacitors	78
HQ Series, High Q, High RF Power Chips	79
HQL Series, High Q, High RF Power, Ribbon Leaded	80
GX Series	81

FILM CHIP CAPACITORS

CB-PET Dielectric High Temperature Film Chips	82
CB-PEN Dielectric Film Chips	83
CB-PPS Dielectric Film Chips	84

LEADED CAPACITORS - MLC

SR Series SkyCap® NPO Conformal Coated, Radial Leaded	85
SR Series SkyCap® X7R Conformal Coated, Radial Leaded	86
SR Series SkyCap® Z5U Conformal Coated, Radial Leaded	87
SL Series SkyCap® NPO Conformal Coated, Radial Leaded	88
SL Series SkyCap® X7R Conformal Coated, Radial Leaded	89
SL Series SkyCap® Z5U Conformal Coated, Radial Leaded	90
AR Series SkyCap® NPO Conformal Coated, Radial Leaded, Automotive ..	91
AR Series SkyCap® X7R Conformal Coated, Radial Leaded, Automotive ..	92
AR Series SkyCap® X8R Conformal Coated, Radial Leaded, Automotive ..	93
MR Series NPO Molded Radial Leaded	94
MR Series X7R Molded Radial Leaded	95
MR Series Z5U Molded Radial Leaded	96
MD Series Molded 2 Pin DIP	97
SA Series SpinGuard® NPO Conformal Coated, Axial Leaded	98
SA Series SpinGuard® X7R Conformal Coated, Axial Leaded	99
SA Series SpinGuard® X5R Conformal Coated, Axial Leaded	100
SA Series SpinGuard® Z5U Conformal Coated, Axial Leaded	101
MA Series NPO Molded Axial Leaded	102
MA Series X7R Molded Axial Leaded	103
MA Series Z5U Molded Axial Leaded	104
SV Series Leaded Capacitors for High Voltage Applications - NPO	105
SV Series Leaded Capacitors for High Voltage Applications - X7R	106

LEADED CAPACITORS - TANTALUM

TAP Dipped Radial Capacitors	107
TEP Dipped Radial Capacitors – Tin/Lead Finish	108

SUPERCAPACITORS

BestCap® Pulse Application Supercapacitors	109
TLN PulseCap™ Tantalum Solid Electrolytic Chip Capacitors	110

CIRCUIT PROTECTION

Sub pf Varistor	111
V2F1	112
V3F4	113
VC	114
MG	115
NC20	116
Surface Mount Fuses	117

HIGH RELIABILITY

Military & Established Reliability Product Line Card	118-119
--	---------

MILITARY/AEROSPACE TANTALUM CAPACITORS

TAZ CWR09 - MIL-PRF-55365/4 Established Reliability, COTS-Plus & Space Level	120
TAZ CWR19 - MIL-PRF-55365/11	121
TAZ CWR29 - MIL-PRF-55365/11 Established Reliability, COTS-Plus & Space Level	122
TAZ Extended Range - 63V COTS-Plus	123
TCP Low ESR Tantalum Modules	124
TBJ CWR11 - MIL-PRF-55365/8 Established Reliability, COTS-Plus & Space Level	125
TBJ COTS-Plus - DSCC Dwgs 07016 & 95158, Weibull Grade & Space Level	126
TBM Multianode Tantalum Ultra Low ESR COTS-Plus, Weibull Grade & Space Level	127
TBW Tantalum Fused DSCC Dwg 04053 COTS-Plus, Weibull Grade & Space Level	128
TBC CWR15 Military Small Case Size Tantalum Capacitors	129
TBC COTS-Plus	130
NBS COTS-Plus	131
NBM Multianode OxiCap® Ultra Low ESR Capacitor COTS-Plus, Weibull Grade	132
TWA Wet Electrolytic Tantalum Capacitor	133

MILITARY/AEROSPACE CERAMIC CAPACITORS

MIL 123 Leaded	134
MIL-PRF-123/Chip	135

CDR STYLE CAPACITORS, MIL-PRF-55681

CDR01 - CDR06	136-137
CDR31 - CDR35	138
Extended Range Surface Mount MLCC	
DSCC 03028, 0603 case size; 06019RF, 0605 case;	
DSCC 0502, 0603 case; DSCC 03029, 0402 case;	
DSCC 06022RF, 1210 case	139
DSCC 05006, 0805 case size;	
DSCC 05007, 1206 case size	140

SWITCH MODE POWER SUPPLY CAPACITORS (HI CAP VALUE)

SMPS Stacked MLC Capacitors SM Style Surface Mount and Thru-Hole Styles (SM0, SM5)	141
Stacked Leaded MLC Capacitors CH-CV Series	142
BR	143
HP/HW - HD/HE	144
CKR	145
Single-In-Line Packages (SIP) Capacitor Arrays	146

RF CAPACITORS

CDR11 - CDR14	147
---------------	-----

EMI FILTERS

Solder in EMI	148
Bolt in EMI	149
Cylindrical EMI	150
Custom EMI	151
Feedthru 0805/1206 Capacitors - W2F/W3F Series	152
High Current Feedthru Filter - W2H/W3H Series	153
Tin/Lead Feedthru 0805/1206 Capacitors - L2F/L3F Series	154
Tin/Lead High Current Feedthru Filter - L2H/L3H Series	155
Feedthru Array Filters - W2F4/W3F4 Series	156

ALTERNATE ENERGY

TRAFIM	157-160
FFB*	161-163
FFV3*	164-166
FFG/FFH (RoHS Compliant)	167-169
FFVE & FFVI/FFWE & FFVI (RoHS Compliant)	170-173
FFVS*	174-175
FFLI*	176-177
FFLC*	178-179
FSM/FSN (RoHS Compliant)	180-181
FSB*	182-185
FSV*	186-187
FPX/FPY (RoHS Compliant)	188-190
FPG/FPH (RoHS Compliant)	191-193
DISFIM	194

*RoHS Compliant series as standard.

GLASS CAPACITORS

MIL-PRF-23269	195-196
---------------	---------

CONNECTORS

MIL-C-55074 Hermaphracon Connectors	197
Varicon 8219	198
Varicon 8223	199
M55302 Two Piece Edge Board Connectors	200

CERAMIC CAPACITORS

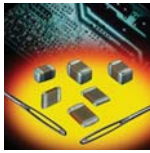

Surface Mount Multilayer Ceramic Capacitors

Automotive	HiCV
MIL/COTS-Plus/Space	High Temperature
CDR/High Reliability	Array
Flexiterm®	Tip and Ring
Flexisafe™	Low Distortion
Ultrathin	Gold Terminated
Tin/Lead	Tin/Lead w Flexiterm®



Switch Mode Power Supply Capacitors (SMPS)

MIL/Space	High Temp
Leaded	High Voltage
TurboCap™	



Leaded Multilayer Ceramic Capacitors

Axial	High Voltage
Radial	MIL/Space/High
Reliability	
2-Pin Dip	



High Voltage

Surface Mount	Flexiterm®
Leaded	MIL

Glass Capacitor

LOW INDUCTANCE / SIGNAL INTEGRITY

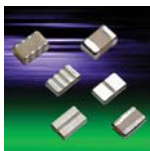

Reverse Geometry

Interdigitated

Ultra Low Inductance

CoreCap® Hybrid Niobium Oxide - MLCC

Low Inductance Array

TANTALUM CAPACITORS



Surface Mount Tantalum Capacitors

Low ESR	High Temp (THJ)
CWR	Established Reliability
Polymer	TACmicrochip®
Fused	Tin/Lead



Leaded Tantalum Capacitors

Wet Tantalum
Radial Leaded



Niobium Oxide / OxiCap®

Low ESR
COTS-Plus
Multinode

RF PRODUCTS

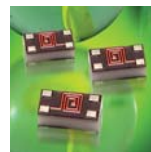

Inductors – Thin-Film

Filters

Band Pass	Custom
Low Pass	EMI

Passive Miniaturized Components

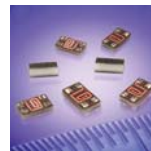

Couplers

3dB	3dB 90°
High Directivity	Splitter/Combiner



Capacitors

Microwave	Medium Power
Single Layer	Tight Tolerance/Thin-Film
High Power	RF Capacitors
Broadband	DC Block

ENERGY HARVESTING



Film Capacitors

Surface Mount Film Capacitors
Medium Power Film
High Power Film



Ceramic Capacitors

Molded Ceramic
Stacked Ceramic



Tantalum Capacitors

Multi-Anode (low ESR)
Stacked Capacitors

Pulse Power Supercap

BestCap®

CIRCUIT PROTECTION



MLV Transient Voltage Suppressors

Varistors
Multi-element Varistors
Feedthru Varistors
Application Specific Varistors

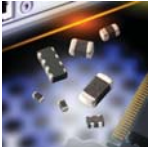

AntennaGuard High Temperature
USB Series Sub pF
CAN Series Low Leakage
StaticGuard Maxcap
Automotive Series Capguard
Medium Power Varistors

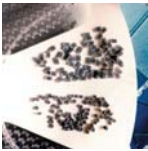

Thermistors

Negative Temperature Compensation
Leaded
Surface Mount



Fuses – Thin-Film

CONNECTORS



LED/Solid State Lighting

Wire to Board
Board to Board
End Cap

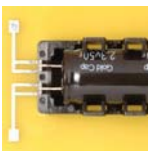

Board to Board

DIN 41612 2-Piece
Compression Low Profile 1-Piece
Microleaf/Fine Pitch 2-Piece



Automotive

Custom connectors/modules
Pressfit
Insulation Displacement



Portable Devices

Battery
SIM
Memory Products
Speaker/Microphone
I/O

FILTERS



EMI Filters

Surface Mount Bulkhead
High Current MIL/Space



Noise Filters

Low Pass Filters

Ceramic Filters

SAW Filters

Filtered Arrays

Optical Low Pass

PIEZOELECTRIC DEVICES



Telephone Ringer/External Drive

External Drive/Self-Oscillating

Shock Sensor

Actuator

TIMING PRODUCTS



Oscillators

Crystals

Resonators

Standard NP0 (C0G) MLCC

Standard NP0 Dielectric

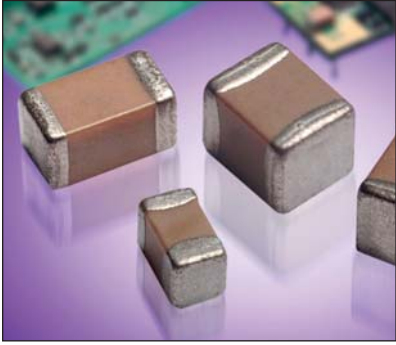

C0G (NP0) is the most popular formulation of the “temperature-compensating,” EIA Class I ceramic materials. Modern C0G (NP0) formulations contain neodymium, samarium and other rare earth oxides.

C0G (NP0) ceramics offer one of the most stable capacitor dielectrics available. Capacitance change with temperature is $0 \pm 30\text{ppm}/^\circ\text{C}$ which is less than $\pm 0.3\%$ ΔC from -55°C to $+125^\circ\text{C}$. Capacitance drift or hysteresis for C0G (NP0) ceramics is negligible at less than $\pm 0.05\%$ versus up to $\pm 2\%$ for films. Typical capacitance change with life is less than $\pm 0.1\%$ for C0G (NP0), one-fifth that shown by most other dielectrics. C0G (NP0) formulations show no aging characteristics.

Check for up-to-date CV Tables at <http://www.avx.com/docs/catalogs/ccog.pdf>

HOW TO ORDER

- 0805**
 - 5**
 - A**
 - 101**
 - J**
 - A**
 - T**
 - 2**
 - A**
- Size (L" x W")**
Y = 16V
3 = 25V
5 = 50V
1 = 100V
2 = 200V
7 = 500V
- Voltage**
- Dielectric**
C0G (NP0) = A
- Capacitance Code (In pF)**
2 Sig. Digits + Number of Zeros
- Capacitance Tolerance**
B = ± 10 pF (<10pF)
C = ± 25 pF (<10pF)
D = ± 50 pF (<10pF)
F = $\pm 1\%$ (≥ 10 pF)
G = $\pm 2\%$ (≥ 10 pF)
J = $\pm 5\%$
K = $\pm 10\%$
- Failure Rate**
A = Not Applicable
- Terminations**
T = Plated Ni and Sn
7 = Gold Plated
- Packaging**
2 = 7" Reel
4 = 13" Reel
7 = Bulk Cass.
9 = Bulk
- Special Code**
A = Std. Product
- Contact Factory For**
1 = Pd/Ag Term
- Contact Factory For Multiples**

NOTE: Contact factory for availability of Termination and Tolerance Options for Specific Part Numbers. Contact factory for non-specified capacitance values.

SIZE	0201				0402				0603				0805				1206				1210				1812				1825				2220				2225												
	25	50	16	25	50	16	25	50	100	16	25	50	100	200	16	25	50	100	200	500	25	50	100	200	500	25	50	100	200	500	50	100	200	50	100	200	50	100	200	50	100	200							
Cap (pF)	0.5	1.0	1.2	1.5	1.8	2.2	2.7	3.3	3.9	4.7	5.6	6.8	8.2	10	12	15	18	22	27	33	39	47	56	68	82	100	120	150	180	220	270	330	390	470	560	680	820	1000	1200	1500	1800	2200	2700	3300	3900	4700	5600	6800	8200
Cap (uF)	0.010	0.012	0.015	0.018	0.022	0.027	0.033	0.039	0.047	0.056	0.068	0.082	0.100	0.120	0.150	0.180	0.220	0.270	0.330	0.390	0.470	0.560	0.680	0.820	0.010	0.012	0.015	0.018	0.022	0.027	0.033	0.039	0.047	0.056	0.068	0.082	0.100	0.120	0.150	0.180	0.220	0.270	0.330	0.390	0.470	0.560	0.680	0.820	

Letter	A	C	E	G	J	K	M	N	P	Q	X	Y	Z
Max. Thickness	0.33 (0.013)	0.56 (0.022)	0.71 (0.028)	0.90 (0.035)	0.94 (0.037)	1.02 (0.040)	1.27 (0.050)	1.40 (0.055)	1.52 (0.060)	1.78 (0.070)	2.29 (0.090)	2.54 (0.100)	2.79 (0.110)
	PAPER					EMBOSSED							



Standard X7S MLCC

X7S Dielectric

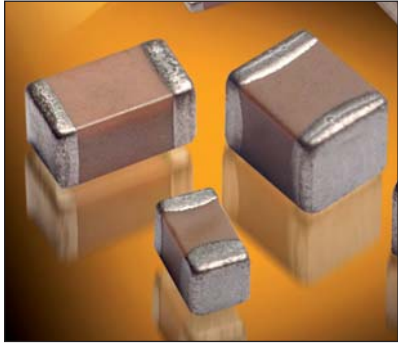

X7S formulations are classified as “temperature stable” ceramics and fall into EIA Class II materials. Its temperature variation of capacitance is within $\pm 22\%$ from -55°C to $+125^{\circ}\text{C}$. This capacitance change is non-linear.

Capacitance for X7S varies under the influence of electrical operating conditions such as voltage and frequency.

X7S dielectric chip usage covers the broad spectrum of industrial applications where known changes in capacitance due to applied voltages are acceptable.



Check for up-to-date CV Tables at
<http://www.avx.com/docs/catalogs/cx7s.pdf>

HOW TO ORDER

1206	Z	Z	105	M	A	T	2	A
↓	↓	↓	↓	↓	↓	↓	↓	↓
Size (L" x W")	Voltage	Dielectric	Capacitance Code (In pF) 2 Sig. Digits + Number of Zeros	Capacitance Tolerance	Failure Rate	Terminations	Packaging	Special Code
4 = 4V 6 = 6.3V Z = 10V 3 = 25V	Z = X7S	K = $\pm 10\%$ M = $\pm 20\%$	A = N/A	T = Plated Ni and Sn	2 = 7" Reel 4 = 13" Reel 7 = Bulk Cass.	A = Std. Product		

NOTE: Contact factory for availability of Tolerance Options for Specific Part Numbers.

SIZE	0402	0603		0805	1206		1210
WVDC	6.3	6.3	25	4	6.3	10	6.3
Cap (pF)	100						
	150						
	220						
	330						
	470						
	680						
	1000						
	1500						
	2200						
	3300						
	4700						
	6800						
Cap (μF)	0.010						
	0.015						
	0.022						
	0.033	C					
	0.047	C					
	0.068	C					
	0.10	C					
	0.15						
	0.22		G				
	0.33		G				
	0.47		G				
	0.68		G				
	1.0		G				
	1.5			N	Q		
	2.2			N	Q		
	3.3			N	Q		
	4.7			N	Q	Q	
	10						
	22						Z
	47						
	100						
WVDC	6.3	6.3	25	4	6.3	10	6.3
SIZE	0402	0603		0805	1206		1210

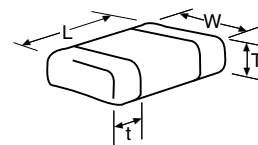

Letter	A	C	E	G	J	K	M	N	P	Q	X	Y	Z
Max. Thickness	0.33 (0.013)	0.56 (0.022)	0.71 (0.028)	0.90 (0.035)	0.94 (0.037)	1.02 (0.040)	1.27 (0.050)	1.40 (0.055)	1.52 (0.060)	1.78 (0.070)	2.29 (0.090)	2.54 (0.100)	2.79 (0.110)
	PAPER					EMBOSSED							

MLCC Low Profile

General Specifications

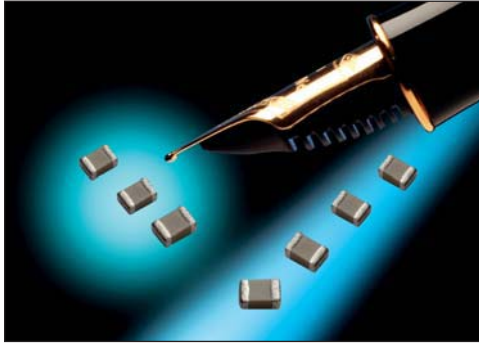

AVX introduces the LT series comprising a range of low profile products in our X5R and X7R dielectric. X5R is a Class II dielectric with temperature variation of capacitance within $\pm 15\%$ from -55°C to $+85^{\circ}\text{C}$. Offerings include 0201, 0402, 0603, 0805, 1206, and 1210 packages in compact, low profile designs. The LT series is ideal for decoupling and filtering applications where height clearance is limited.

AVX is also expanding the low profile products in our X7R dielectric. X7R is a Class II dielectric with temperature variation of capacitance within $\pm 15\%$ from -55°C to $+125^{\circ}\text{C}$. Please contact the factory for availability of any additional values not listed.

<http://www.avx.com/docs/catalogs/lt02-06.pdf>

HOW TO ORDER

LT05	Z	D	475	M	A	T	2	S
Size LT01 - 0201 LT02 - 0402 LT03 - 0603 LT05 - 0805 LT06 - 1206 LT10 - 1210	Voltage 4 = 4V 6 = 6.3V Z = 10V Y = 16V 3 = 25V	Dielectric X5R = D X7R = C	Capacitance Code (In pF) 2 Sig. Digits + Number of Zeros	Capacitance Tolerance K = $\pm 10\%$ M = $\pm 20\%$	Failure Rate A = Not Applicable	Terminations T = Plated Ni and Sn	Packaging 2 = 7" Reel 4 = 13" Reel 7 = Bulk Cass. 9 = Bulk	Special Code See table below
Contact Factory For Multiples								

NOTE: Contact factory for availability of Tolerance Options for Specific Part Numbers.

SIZE		LT01	LT02			LT03				LT05				LT06			LT10			
	WDC	4	4	6.3	10	16	4	6.3	16	25	6.3	10	16	25	10	16	25	16	25	
Cap (µF)	104	Z		Q		S														
										X										
										X									X	
105	1.0		C		S				S	X			X	X						
	1.5																			
	2.2		S					S	X				X							
106	4.7						S	X				S	X			W	W	W		
	10						X/W				X	X			W		W			
	22																			
	47																			
	WDC	4	4	6.3	10	16	4	6.3	16	25	6.3	10	16	25	10	16	25	16	25	
SIZE		LT01	LT02			LT03				LT05				LT06			LT10			

 = X7R

Letter	J	Z	Q	C	S	X	W
Max. Thickness	0.15 (0.006)	0.22 (0.009)	0.25 (0.010)	0.36 (0.014)	0.56 (0.022)	0.95 (0.038)	1.02 (0.040)
	PAPER						EMBOSSED



Standard Y5V MLCC

Y5V Dielectric

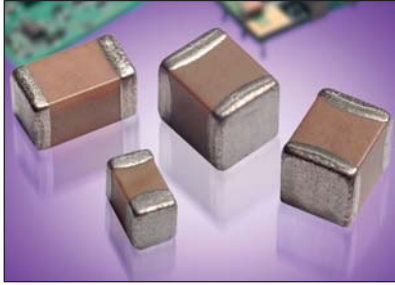

Y5V formulations are for general-purpose use in a limited temperature range. They have a wide temperature characteristic of +22% -82% capacitance change over the operating temperature range of -30°C to +85°C.

These characteristics make Y5V ideal for decoupling applications within limited temperature range.

Check for up-to-date CV Tables at <http://www.avx.com/docs/catalogs/cy5v.pdf>

HOW TO ORDER

0805

Size
(L" x W")

3

Voltage
6 = 6.3V
Z = 10V
Y = 16V
3 = 25V
5 = 50V

G

Dielectric
Y5V = G

104

Capacitance Code (In pF)
2 Sig. Digits +
Number of Zeros

Z

Capacitance Tolerance
Z = +80 -20%

A

Failure Rate
A = Not Applicable

T

Terminations
T = Plated Ni and Sn

2

Packaging
2 = 7" Reel
4 = 13" Reel

A

Special Code
A = Std. Product

SIZE	0201		0402				0603				0805				1206				1210								
WVDC	6.3	10	6	10	16	25	50	10	16	25	50	10	16	25	50	10	16	25	50	10	16	25	50				
Cap (pF)	820																										
	1000	A																									
	2200	A																									
Cap (µF)	4700																										
	0.010	A	A																								
	0.022	A																									
	0.047	A																									
	0.10				C	C					G	G							K								
	0.22																										
	0.33										G																
	0.47					C					G	G															
	1.0			C	C						G				N	N	N			M	M	M					
	2.2																						N				
	4.7				C										N	N											
	10.0																										
	22.0																										
	47.0																										
WVDC	6.3	10	6	10	16	25	50	10	16	25	50	10	16	25	50	10	16	25	50	10	16	25	50	10	16	25	50

Letter	A	C	E	G	J	K	M	N	P	Q	X	Y	Z
Max. Thickness	0.33 (0.013)	0.56 (0.022)	0.71 (0.028)	0.90 (0.035)	0.94 (0.037)	1.02 (0.040)	1.27 (0.050)	1.40 (0.055)	1.52 (0.060)	1.78 (0.070)	2.29 (0.090)	2.54 (0.100)	2.79 (0.110)
	PAPER					EMBOSSED							



High Voltage MLCC (RoHS)

Applications from 600V to 5000V

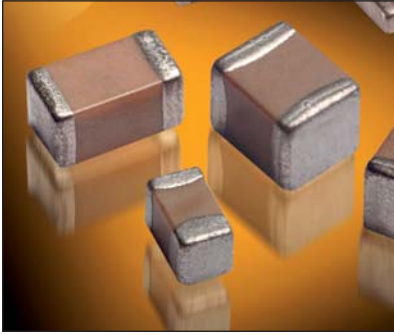

High value, low leakage and small size are difficult parameters to obtain in capacitors for high voltage systems. AVX special high voltage MLC chip capacitors meet these performance characteristics and are designed for applications such as snubbers in high frequency power converters, resonators in SMPS, and high voltage coupling/dc blocking. These high voltage chip designs exhibit low ESRs at high frequencies.

Larger physical sizes than normally encountered chips are used to make high voltage MLC chip products. Special precautions must be taken in applying these chips in surface mount assemblies. The temperature gradient during heating or cooling cycles should not exceed 4°C per second. The preheat temperature must be within 50°C of the peak temperature reached by the ceramic bodies through the soldering process. Chip sizes 1210 and larger should be reflow soldered only. Capacitors may require protective surface coating to prevent external arcing.

For 1825, 2225 and 3640 sizes, AVX offers leaded version in either thru-hole or SMT configurations (for details see section on high voltage leaded MLC chips).

NEW 630V RANGE

HOW TO ORDER

Check for up-to-date CV Tables at <http://www.avx.com/docs/catalogs/aphvc.pdf>

1808	A	A	271	K	A	1	1	A
AVX Style	Voltage	Temperature Coefficient	Capacitance Code (2 significant digits + no. of zeros) Examples:	Capacitance Tolerance COG: J = ±5% K = ±10% M = ±20% X7R: K = ±10% M = ±20% Z = +80%, -20%	Test Level A = Standard	Termination* 1 = Pd/Ag T = NiGuard Nickel Barrier Solderable Plate	Packaging 1 = 7" Reel 3 = 13" Reel 9 = Bulk	Special Code A = Standard
0805 1206 1210 1808 1812 1825 2220 2225 3640 ***	C = 600V/630V A = 1000V S = 1500V G = 2000V W = 2500V H = 3000V J = 4000V K = 5000V	COG = A X7R = C	10 pF = 100 100 pF = 101 1,000 pF = 102 22,000 pF = 223 220,000 pF = 224 1 μF = 105					

*Note: Terminations with 5% minimum lead (Pb) is available for LD style. Leaded terminations are also available.

NOTE: Contact factory for availability of Termination and Tolerance Options for Specific Part Numbers.

*** AVX offers nonstandard chip sizes. Contact factory for details.

HIGH VOLTAGE COG CAPACITANCE VALUES

VOLTAGE	0805	1206	1210	1808	1812	1825	2220	2225	3640
600/630	min. 10pF max. 330pF	10 pF 1200 pF	100 pF 2700 pF	100 pF 3300 pF	100 pF 5600 pF	1000 pF 0.012 μF	1000 pF 0.012 μF	1000 pF 0.018 μF	1000 pF 0.047 μF
1000	min. 10pF max. 180pF	10 pF 560 pF	10 pF 1500 pF	100 pF 2200 pF	100 pF 3300 pF	100 pF 8200 pF	1000 pF 0.010 μF	1000 pF 0.010 μF	1000 pF 0.022 μF
1500	min. — max. —	10 pF 270 pF	10 pF 680 pF	10 pF 820 pF	10 pF 1800 pF	100 pF 4700 pF	100 pF 4700 pF	100 pF 5600 pF	100 pF 0.010 μF
2000	min. — max. —	10 pF 120 pF	10 pF 270 pF	10 pF 330 pF	10 pF 1000 pF	100 pF 1800 pF	100 pF 2200 pF	100 pF 2700 pF	100 pF 6800 pF
2500	min. — max. —	—	—	10 pF 180 pF	10 pF 470 pF	10 pF 1200 pF	100 pF 1500 pF	100 pF 1800 pF	100 pF 3900 pF
3000	min. — max. —	—	—	10 pF 120 pF	10 pF 330 pF	10 pF 820 pF	10 pF 1000 pF	10 pF 1200 pF	100 pF 2700 pF
4000	min. — max. —	—	—	10 pF 47 pF	10 pF 150 pF	10 pF 330 pF	10 pF 470 pF	10 pF 560 pF	100 pF 1200 pF
5000	min. — max. —	—	—	—	—	—	10 pF 220 pF	10 pF 270 pF	10 pF 820 pF

HIGH VOLTAGE X7R CAPACITANCE VALUES

VOLTAGE	0805	1206	1210	1808	1812	1825	2220	2225	3640
600/630	min. 100pF max. 6800pF	1000 pF 0.022 μF	1000 pF 0.056 μF	1000 pF 0.068 μF	1000 pF 0.120 μF	0.010 μF 0.270 μF	0.010 μF 0.270 μF	0.010 μF 0.330 μF	0.010 μF 0.560 μF
1000	min. 100pF max. 1500pF	100 pF 6800 pF	1000 pF 0.015 μF	1000 pF 0.018 μF	1000 pF 0.039 μF	1000 pF 0.100 μF	1000 pF 0.120 μF	1000 pF 0.150 μF	1000 pF 0.220 μF
1500	min. — max. —	100 pF 2700 pF	100 pF 5600 pF	100 pF 6800 pF	100 pF 0.015 μF	1000 pF 0.056 μF	1000 pF 0.056 μF	1000 pF 0.068 μF	1000 pF 0.100 μF
2000	min. — max. —	10 pF 1500 pF	100 pF 3300 pF	100 pF 3300 pF	100 pF 8200 pF	100 pF 0.022 μF	1000 pF 0.027 μF	1000 pF 0.033 μF	1000 pF 0.027 μF
2500	min. — max. —	—	—	10 pF 2200 pF	10 pF 5600 pF	100 pF 0.015 μF	100 pF 0.018 μF	100 pF 0.022 μF	1000 pF 0.022 μF
3000	min. — max. —	—	—	10 pF 1800 pF	10 pF 3900 pF	100 pF 0.010 μF	100 pF 0.012 μF	100 pF 0.015 μF	1000 pF 0.018 μF
4000	min. — max. —	—	—	—	—	—	—	—	100 pF 6800 pF
5000	min. — max. —	—	—	—	—	—	—	—	100 pF 3300 pF



High Voltage FLEXITERM®

For 600V to 3000V Applications

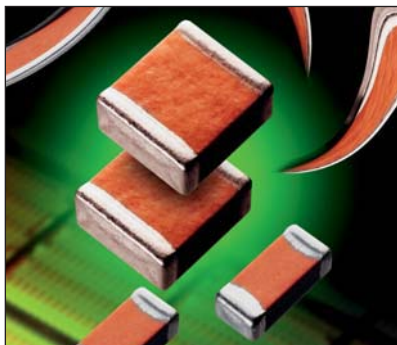

High value, low leakage and small size are difficult parameters to obtain in capacitors for high voltage systems. AVX special high voltage MLC chip capacitors meet these performance characteristics and are designed for applications such as snubbers in high frequency power converters, resonators in SMPS, and high voltage coupling/DC blocking. These high voltage chip designs exhibit low ESRs at high frequencies.

To make high voltage chips, larger physical sizes than are normally encountered are necessary. These larger sizes require that special precautions be taken in applying these chips in surface mount assemblies. In response to this, and to follow from the success of the FLEXITERM® range of low voltage parts, AVX is delighted to offer a FLEXITERM® high voltage range of capacitors, FLEXITERM®.

The FLEXITERM® layer is designed to enhance the mechanical flexure and temperature cycling performance of a standard ceramic capacitor, giving customers a solution where board flexure or temperature cycle damage are concerns.

Check for up-to-date CV Tables at <http://www.avx.com/docs/catalogs/flexitermhv.pdf>

HOW TO ORDER

1808	A	C	272	K	A	Z	1	A
AVX Style	Voltage	Temperature Coefficient	Capacitance Code	Capacitance Tolerance	Test Level	Termination*	Packaging	Special Code
0805	C = 600V/630V	COG = A	(2 significant digits + no. of zeros)	COG:		Z = FLEXITERM®	1 = 7" Reel	A = Standard
1206	A = 1000V	X7R = C	Examples:	J = ±5%		100% Tin (RoHS Compliant)	3 = 13" Reel	
1210	S = 1500V		10 pF = 100	K = ±10%			9 = Bulk	
1808	G = 2000V		100 pF = 101	M = ±20%				
1812	W = 2500V		1,000 pF = 102	X7R:				
1825	H = 3000V		22,000 pF = 223	K = ±10%				
2220			220,000 pF = 224	M = ±20%				
2225			1 µF = 105	Z = +80%, -20%				

Notes: Capacitors with X7R dielectrics are not intended for applications across AC supply mains or AC line filtering with polarity reversal. Contact plant for recommendations. Contact factory for availability of Termination and Tolerance options for Specific Part Numbers.

*** AVX offers nonstandard chip sizes. Contact factory for details.

HIGH VOLTAGE COG CAPACITANCE VALUES

VOLTAGE	0805	1206	1210	1808	1812	1825	2220	2225
600/630	min.	10pF	10 pF	100 pF	100 pF	100 pF	1000 pF	1000 pF
	max.	330pF	1200 pF	2700 pF	3300 pF	5600 pF	0.012 µF	0.012 µF
1000	min.	10pF	10 pF	10 pF	100 pF	100 pF	100 pF	1000 pF
	max.	180pF	560 pF	1500 pF	2200 pF	3300 pF	8200 pF	0.010 µF
1500	min.	—	10 pF	10 pF	10 pF	10 pF	100 pF	100 pF
	max.	—	270 pF	680 pF	820 pF	1800 pF	4700 pF	4700 pF
2000	min.	—	10 pF	10 pF	10 pF	10 pF	100 pF	100 pF
	max.	—	120 pF	270 pF	330 pF	1000 pF	1800 pF	2200 pF
2500	min.	—	—	—	10 pF	10 pF	10 pF	100 pF
	max.	—	—	—	180 pF	470 pF	1200 pF	1500 pF
3000	min.	—	—	—	10 pF	10 pF	10 pF	10 pF
	max.	—	—	—	120 pF	330 pF	820 pF	1000 pF

HIGH VOLTAGE X7R CAPACITANCE VALUES

VOLTAGE	0805	1206	1210	1808	1812	1825	2220	2225
600/630	min.	100pF	1000 pF	1000 pF	1000 pF	1000 pF	0.010 µF	0.010 µF
	max.	6800pF	0.022 µF	0.056 µF	0.068 µF	0.120 µF	0.270 µF	0.270 µF
1000	min.	100pF	100 pF	1000 pF	1000 pF	1000 pF	1000 pF	1000 pF
	max.	1500pF	6800 pF	0.015 µF	0.018 µF	0.039 µF	0.100 µF	0.120 µF
1500	min.	—	100 pF	100 pF	100 pF	100 pF	1000 pF	1000 pF
	max.	—	2700 pF	5600 pF	6800 pF	0.015 µF	0.056 µF	0.056 µF
2000	min.	—	10 pF	100 pF	100 pF	100 pF	1000 pF	1000 pF
	max.	—	1500 pF	3300 pF	2300 pF	8200 pF	0.022 µF	0.027 µF
2500	min.	—	—	—	10 pF	10 pF	100 pF	100 pF
	max.	—	—	—	2200 pF	5600 pF	0.015 µF	0.018 µF
3000	min.	—	—	—	10 pF	10 pF	100 pF	100 pF
	max.	—	—	—	1800 pF	2200 pF	0.010 pF	0.012 µF

UltraThin Ceramic Capacitors

UT023D103MAT2C

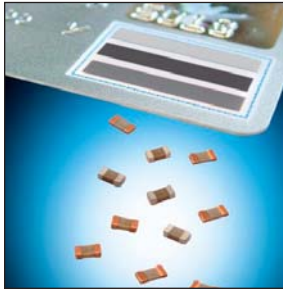

The Ultrathin (UT) series of ceramic capacitors is a new product offering from AVX. The UT series was designed to meet the stringent thickness requirements of our customers. AVX developed a new termination process (FCT - Fine Copper Termination) that provides unbeatable flatness and repeatability. The series includes products < 0.35mm in height and is targeted for applications such as Smart cards, Memory modules, High Density SIM cards, Mobile phones, MP3 players, and embedded solutions.

 Check for up-to-date CV Tables at
<http://www.avx.com/docs/catalogs/ut.pdf>

HOW TO ORDER

UT	02	3	D	103	M	A	T	2	C
Style Ultra Thin	Case Size 0402	Rated Voltage 25V	Temperature Characteristic X5R	Coded Cap 0.01µF	Cap Tolerance ± 20%	Termination Style Commercial	Termination 100% Sn	Packaging 7" Reel = 15,000 pcs 13" Reel = 50,000 pcs	Thickness 0.30mm max

PART DIMENSIONS

mm (inches)

L	W	T	BL
1.00 ± 0.10 (0.039±0.004)	0.50 ± 0.10 (0.020 ± 0.004)	0.25 ± 0.05 (0.010 ± 0.002)	0.25 ± 0.10 (0.010 ± 0.004)

PERFORMANCE CHARACTERISTICS

Capacitance Value	0.01µF
Capacitance Tolerance	±20%
Dissipation Factor Range	3.0%
Operating Temperature	-55°C to +85°C
Temperature Coefficient	±15%
Rated Voltage	25V
Insulation Resistance at 25°C and Rated Voltage	100,000 Mohms
Test Frequency	1 Vrms @ 1 KHz

Tip & Ring

Multilayer Ceramic Chip Capacitors

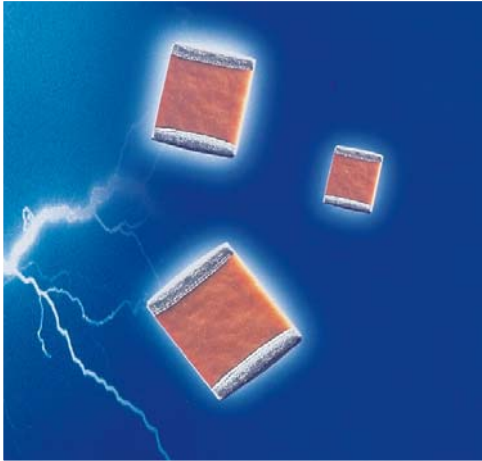

AVX “Tip & Ring” or “ring detector” Multilayer Ceramic Chip Capacitors are designed as a standard telecom filter to block -48 Volts DC telephone line voltage and pass subscriber’s AC signal pulse (16 to 25Hz, 70 to 90Vrms). The ringer capacitors replace large leaded film capacitors and are ideal for telecom/modem applications. Using AVX “Tip & Ring” capacitors not only saves valuable real estate on the board and reduces the weight of overall product, but also features standard surface mounting capabilities so critical to new and compact designs.

The AVX “Tip & Ring” capacitors are offered in standard EIA sizes and standard values. They offer excellent high frequency performance, low ESR and improved temperature performance over film capacitors.

[Check for up-to-date CV Tables at
http://www.avx.com/docs/catalogs/apt&r.pdf](http://www.avx.com/docs/catalogs/apt&r.pdf)

HOW TO ORDER

1812

AVX Style
0805
1206
1210
1808
1812
1825
2220
2225

P

Voltage
250 VDC
Telco
Rating

C

Temperature Coefficient
X7R

104

Capacitance Code
(2 significant digits + no. of zeros)
Examples:
1,000 pF = 102
22,000 pF = 223
220,000 pF = 224
1 μ F = 105

K

Capacitance Tolerance
K = \pm 10%
M = \pm 20%

A

Test Level
A = Standard

T

Termination
T = Plated
Ni and Sn
(RoHS Compliant)
Z = FLEXITERM®
100% Tin
(RoHS Compliant)

1

Packaging
2 = 7" Reel
4 = 13" Reel
6 = Bulk

A

Special Code
A = Standard

Contact factory for availability of Termination and Tolerance options for Specific Part Numbers.



PERFORMANCE CHARACTERISTICS

Capacitance Range	1000 pF to 1.2 μ F (25°C, 1.0 \pm 0.2 Vrms at 1kHz)
Capacitance Tolerances	\pm 10%, \pm 20%
Dissipation Factor	2.5% max. (25°C, 1.0 \pm 0.2 Vrms at 1kHz)
Operating Temperature Range	-55°C to +125°C
Temperature Characteristic	X7R \pm 15% (0 VDC)
Voltage Rating	250 VDC Telco rating
Insulation Resistance	1000 megohm-microfarad min.
Dielectric Strength	Minimum 200% rated voltage for 5 seconds at 50 mA max. current

CAPACITANCE RANGE (μ F)

Size	0805	1206	1210	1808	1812	1825	2220	2225
min.	0.0010	0.0010	0.0010	0.010	0.10	0.33	0.47	0.47
max.	0.027	0.082	0.22	0.27	0.47	1.0	1.0	1.2

Tin/Lead Termination MLCC

LD Series X5R Dielectric, Tin/Lead



AVX Corporation will support those customers for commercial and military Multilayer Ceramic Capacitors with a termination consisting of 5% minimum lead. This termination is indicated by the use of a “B” in the 12th position of the AVX Catalog Part Number. This fulfills AVX’s commitment to providing a full range of products to our customers. Please contact the factory if you require additional information on our MLCC Tin/Lead Termination “B” products.



Check for up-to-date CV Tables at

<http://www.avx.com/docs/catalogs/tinterm.pdf>

HOW TO ORDER

LD05	5	D	101	J	A	B	2	A
Size LD02 - 0402 LD03 - 0603 LD04 - 0504* LD05 - 0805 LD06 - 1206 LD10 - 1210 LD12 - 1812	Voltage 4 = 4V 6 = 6.3V Z = 10V Y = 16V 3 = 25V D = 35V 5 = 50V	Dielectric X5R = D	Capacitance Code (In pF) 2 Sig. Digits + Number of Zeros	Capacitance Tolerance J = ±5% K = ±10% M = ±20%	Failure Rate A = Not Applicable	Terminations B = 5% min lead	Packaging 2 = 7" Reel 4 = 13" Reel 7 = Bulk Cass. 9 = Bulk	Special Code A = Std. Product

Contact Factory For Multiples

*LD04 has the same CV ranges as LD03.

NOTE: Contact factory for availability of Tolerance Options for Specific Part Numbers. Contact factory for non-specified capacitance values.

SIZE	LD02					LD03					LD05					LD06					LD10					LD12													
	WVDC	4	6.3	10	16	25	50	4	6.3	10	16	25	35	50	6.3	10	16	25	35	50	6.3	10	16	25	35	50	4	6.3	10	16	25	35	50	6.3	10	25	50		
Cap (pF)	100																																						
	150																																						
	220																																						
	330																																						
	470																																						
	680																																						
	1000																																						
	1500																																						
	2200																																						
	3300																																						
	4700																																						
	6800																																						
Cap (μF)	0.010																																						
	0.015																																						
	0.022																																						
	0.033																																						
	0.047																																						
	0.068																																						
	0.10																																						
	0.15																																						
	0.22																																						
	0.33																																						
	0.47																																						
	0.68																																						
	1.0																																						
	1.5																																						
	2.2																																						
	3.3																																						
	4.7																																						
	10																																						
	22																																						
	47																																						
	100																																						

■ = Under development ■ = *Optional Specifications - Contact factory

Letter	A	C	E	G	J	K	M	N	P	Q	X	Y	Z
Max. Thickness	0.33 (0.013)	0.56 (0.022)	0.71 (0.028)	0.90 (0.035)	0.94 (0.037)	1.02 (0.040)	1.27 (0.050)	1.40 (0.055)	1.52 (0.060)	1.78 (0.070)	2.29 (0.090)	2.54 (0.100)	2.79 (0.110)

PAPER EMBOSSED

*Optional Specifications - Contact factory

NOTE: Contact factory for non-specified capacitance values

APS for COTS-Plus Applications

APS Series NP0 Dielectric

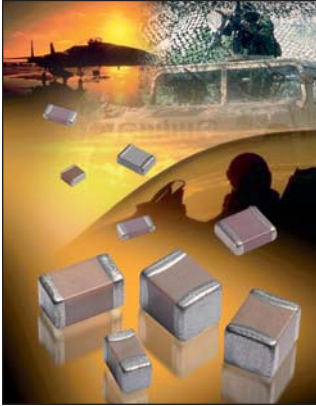

As part of our continuing support to high reliability customers, AVX has launched an Automotive Plus Series of parts (APS) qualified and manufactured in accordance with automotive AEC-Q200 standard. Each production batch is quality tested to an enhanced requirement and shipped with a certificate of conformance. On a quarterly basis a reliability package is issued to all APS customers.

A detailed qualification package is available on request and contains results on a range of part numbers including:

- X7R dielectric components containing BME electrode and copper terminations with a Ni/Sn plated overcoat.
- X7R dielectric components BME electrode and soft terminations with a Ni/Sn plated overcoat (FLEXITERM®).
- X7R for Hybrid applications.
- NP0 dielectric components containing Pd/Ag electrode and silver termination with a Ni/Sn plated overcoat.

We are also able to support customers who require an AEC-Q200 grade component finished with Tin/Lead.

Check for up-to-date CV Tables at <http://www.avx.com/docs/catalogs/aps.pdf>

HOW TO ORDER

AP03	5	A	104	K	Q	T	2	A
Size AP03=0603 AP05=0805 AP06=1206 AP10=1210 AP12=1812	Voltage 3 = 25V 5 = 50V 1 = 100V 2 = 200V 7 = 500V	Dielectric NP0 = A	Capacitance Code (In pF) 2 Significant Digits + Number of Zeros e.g. 10µF = 106	Capacitance Tolerance J = ±5% K = ±10% M = ±20%	Failure Rate Q = APS	Terminations T = Plated Ni and Sn** B = 5% min lead	Packaging 2 = 7" Reel 4 = 13" Reel	Special Code A = Std. Product

NOTE: Contact factory for availability of Termination and Tolerance Options for Specific Part Numbers.

APS MLCC – NP0

	0603			0805			1206					1210				1812	
	25V	50V	100V	25V	50V	100V	25V	50V	100V	200V	500V	25V	50V	100V	200V	50V	100V
100 10pF	G	G	G	J	J	J	J	J	J	J	J						
120 12	G	G	G	J	J	J	J	J	J	J	J						
150 15	G	G	G	J	J	J	J	J	J	J	J						
180 18	G	G	G	J	J	J	J	J	J	J	J						
220 22	G	G	G	J	J	J	J	J	J	J	J						
270 27	G	G	G	J	J	J	J	J	J	J	J						
330 33	G	G	G	J	J	J	J	J	J	J	J						
390 39	G	G	G	J	J	J	J	J	J	J	J						
470 47	G	G	G	J	J	J	J	J	J	J	J						
510 51	G	G	G	J	J	J	J	J	J	J	J						
560 56	G	G	G	J	J	J	J	J	J	J	J						
680 68	G	G	G	J	J	J	J	J	J	J	J						
820 82	G	G	G	J	J	J	J	J	J	J	J						
101 100	G	G	G	J	J	J	J	J	J	J	J						
121 120	G	G	G	J	J	J	J	J	J	J	J						
151 150	G	G	G	J	J	J	J	J	J	J	J						
181 180	G	G	G	J	J	J	J	J	J	J	J						
221 220	G	G	G	J	J	J	J	J	J	J	J						
271 270	G	G	G	J	J	J	J	J	J	J	J						
331 330	G	G	G	J	J	J	J	J	J	J	J						
391 390	G	G		J	J	J	J	J	J	J	J						
471 470	G	G		J	J	J	J	J	J	J	J						
561 560				J	J	J	J	J	J	J	J						
681 680				J	J	J	J	J	J	J	J						
821 820				J	J	J	J	J	J	J	J						
102 1000				J	J	J	J	J	J	J	J	J	J	J			
122 1200							J	J	J	J	J	J	J	M	M		
152 1500							J	M	M			J	J	M	M		
182 1800							J	M	M			J	J	M	M		
222 2200							J	M	M			J	J	M	M		
272 2700							J	M	Q			J	J	M			
332 3300							J	M	Q			J	J	P		K	K
392 3900												J	J	P		K	K
472 4700												J	J	P		K	K
103 10nF																	
	0603			0805			1206					1210				1812	

Letter	G	J	K	M	N	P	Q	X
Max. Thickness	0.90 (0.035)	0.94 (0.037)	1.02 (0.040)	1.27 (0.050)	1.40 (0.055)	1.52 (0.060)	1.78 (0.070)	2.29 (0.090)
	PAPER		PLASTIC TAPE					

AEC-Q200 qualified
TS 16949, ISO 9001 certified



APS for COTS-Plus Applications

APS Series X7R Dielectric

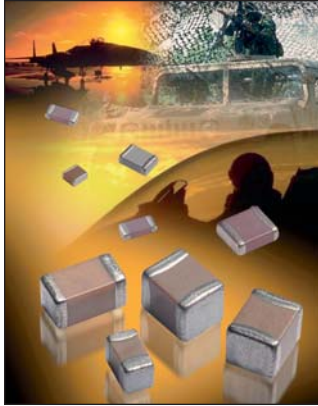

As part of our continuing support to high reliability customers, AVX has launched an Automotive Plus Series of parts (APS) qualified and manufactured in accordance with automotive AEC-Q200 standard. Each production batch is quality tested to an enhanced requirement and shipped with a certificate of conformance. On a quarterly basis a reliability package is issued to all APS customers.

A detailed qualification package is available on request and contains results on a range of part numbers including:

- X7R dielectric components containing BME electrode and copper terminations with a Ni/Sn plated overcoat.
- X7R dielectric components BME electrode and soft terminations with a Ni/Sn plated overcoat (FLEXITERM®).
- X7R for Hybrid applications.
- NP0 dielectric components containing Pd/Ag electrode and silver termination with a Ni/Sn plated overcoat.

We are also able to support customers who require an AEC-Q200 grade component finished with Tin/Lead.

Check for up-to-date CV Tables at <http://www.avx.com/docs/catalogs/aps.pdf>

HOW TO ORDER

AP03	5	C	104	K	Q	T	2	A
Size	Voltage	Dielectric	Capacitance Code (In pF)	Capacitance Tolerance	Failure Rate	Terminations	Packaging	Special Code
AP03=0603 AP05=0805 AP06=1206 AP10=1210 AP12=1812 AP20=2220	Y = 16V 3 = 25V 5 = 50V 1 = 100V 2 = 200V 7 = 500V	X7R = C	2 Significant Digits + Number of Zeros e.g. 10µF = 106	J = ±5% K = ±10% M = ±20%	Q = APS	T = Plated Ni and Sn** Z = FLEXITERM®** U = Conductive Epoxy** B = 5% min lead X = FLEXITERM® with 5% min lead	2 = 7" Reel 4 = 13" Reel	A = Std. Product

**RoHS compliant

NOTE: Contact factory for availability of Termination and Tolerance Options for Specific Part Numbers.

AUTOMOTIVE MLCC – X7R

		0603					0805					1206					1210				1812		2220						
		16V	25V	50V	100V	200V	16V	25V	50V	100V	200V	16V	25V	50V	100V	200V	500V	16V	25V	50V	100V	50V	100V	25V	50V				
102	Cap 1	G	G	G	G	G	J	J	J	J	J	J	J	J	J	J	J	J	J	J	J	K	K	K	K	K	K		
182	(nF) 1.8	G	G	G	G	G	J	J	J	J	J	J	J	J	J	J	J	J	J	J	J	K	K	K	K	K	K		
222	2.2	G	G	G	G	G	J	J	J	J	J	J	J	J	J	J	J	J	J	J	J	K	K	K	K	K	K		
332	3.3	G	G	G	G	G	J	J	J	J	J	J	J	J	J	J	J	J	J	J	J	K	K	K	K	K	K		
472	4.7	G	G	G	G	G	J	J	J	J	J	J	J	J	J	J	J	J	J	J	J	K	K	K	K	K	K		
103	10	G	G	G	G	G	J	J	J	J	J	J	J	J	J	J	J	J	J	J	J	K	K	K	K	K	K		
123	12	G	G	G	G	G	J	J	J	M		J	J	J	J	J	J	J	J	J	J	K	K	K	K	K	K		
153	15	G	G	G	G	G	J	J	J	M		J	J	J	J	J	J	J	J	J	J	K	K	K	K	K	K		
183	18	G	G	G	G	G	J	J	J	M		J	J	J	J	J	J	J	J	J	J	K	K	K	K	K	K		
223	22	G	G	G	G	G	J	J	J	M		J	J	J	J	J	J	J	J	J	J	K	K	K	K	K	K		
273	27	G	G	G	G	G	J	J	J	M		J	J	J	J	J	J	J	J	J	J	K	K	K	K	K	K		
333	33	G	G	G	G	G	J	J	J	M		J	J	J	J	J	J	J	J	J	J	K	K	K	K	K	K		
473	47	G	G	G	G	G	J	J	J	M		J	J	J	M	J	J	J	J	M	J	K	K	K	K	K	K		
563	56	G	G	G	G	G	J	J	J	M		J	J	J	M	J	J	J	J	M	J	K	K	K	M	K	K		
683	68	G	G	G	G	G	J	J	J	M		J	J	J	M	J	J	J	J	M	J	K	K	K	M	K	K		
823	82	G	G	G	G	G	J	J	J	M		J	J	J	M	J	J	J	J	M	J	K	K	K	M	K	K		
104	100	G	G	G	G	G	J	J	J	M		J	J	J	M	J	J	J	J	M	J	K	K	K	M	K	K		
124	120						J	J	M			J	J	M			J	J	M			K	K	K	P	K	K		
154	150						M	N	M			J	J	M			K	K	K	P	K	K							
224	220						M	N	M			J	M	M	Q		M	M	M	P	M	M							
334	330						N	N	M			J	M	P	Q		P	P	P	Q	X	X							
474	470						N	N	M			M	M	P	Q		P	P	P	Q	X	X							
684	680						N	N				M	Q	Q	Q		P	P	Q	X	X	X							
105	Cap 1						N	N				M	Q	Q	Q		P	Q	Q	X	X	X							
155	(µF) 1.5											Q	Q				P	Q	Z	Z	X	X							
225	2.2											Q	Q				X	Z	Z	Z	X	Z							
335	3.3																X	Z	Z		Z								
475	4.7																X	Z	Z		Z								
106	10																							Z					
226	22																							Z					
		16V	25V	50V	100V	200V	16V	25V	50V	100V	200V	16V	25V	50V	100V	200V	500V	16V	25V	50V	100V	50V	100V	25V	50V				
		0603					0805					1206					1210				1812		2220						

Under development

Letter	A	C	E	G	J	K	M	N	P	Q	X	Y	Z
Max. Thickness	0.33 (0.013)	0.56 (0.022)	0.71 (0.028)	0.90 (0.035)	0.94 (0.037)	1.02 (0.040)	1.27 (0.050)	1.40 (0.055)	1.52 (0.060)	1.78 (0.070)	2.29 (0.090)	2.54 (0.100)	2.79 (0.110)
	PAPER					EMBOSSED							

High Voltage MLCC (Tin/Lead)

Applications from 600V to 5000V



AVX Corporation will support those customers for commercial and military Multilayer Ceramic Capacitors with a termination consisting of 5% minimum lead. This termination is indicated by the use of a "B" in the 12th position of the AVX Catalog Part Number. This fulfills AVX's commitment to providing a full range of products to our customers. AVX has provided in the following pages, a full range of values that we are offering in this "B" termination.

Larger physical sizes than normally encountered chips are used to make high voltage MLC chip product. Special precautions must be taken in applying these chips in surface mount assemblies. The temperature gradient during heating or cooling cycles should not exceed 4°C per second. The preheat temperature must be within 50°C of the peak temperature reached by the ceramic bodies through the soldering process. Chip sizes 1210 and larger should be reflow soldered only. Capacitors may require protective surface coating to prevent external arcing.

For 1825, 2225 and 3640 sizes, AVX offers leaded version in either thru-hole or SMT configurations (for details see section on high voltage leaded MLC chips).

NEW 630V RANGE

HOW TO ORDER

Check for up-to-date CV Tables at <http://www.avx.com/docs/catalogs/hvtinterm.pdf>

LD08	A	A	271	K	A	B	1	A
AVX Style	Voltage	Temperature Coefficient	Capacitance Code (2 significant digits + no. of zeros) Examples:	Capacitance Tolerance COG: J = ±5% K = ±10% M = ±20% X7R: K = ±10% M = ±20% Z = +80%, -20%	Test Level A = Standard	Termination B = 5% Min Pb	Packaging 1 = 7" Reel 3 = 13" Reel 9 = Bulk	Special Code A = Standard
LD05 - 0805 LD06 - 1206 LD10 - 1210 LD08 - 1808 LD12 - 1812 LD13 - 1825 LD20 - 2220 LD14 - 2225 LD40 - 3640	C = 600V/630V A = 1000V S = 1500V G = 2000V W = 2500V H = 3000V J = 4000V K = 5000V	COG = A X7R = C	10 pF = 100 100 pF = 101 1,000 pF = 102 22,000 pF = 223 220,000 pF = 224 1 μF = 105					

Notes: Capacitors with X7R dielectrics are not intended for applications across AC supply mains or AC line filtering with polarity reversal. Contact plant for recommendations. Contact factory for availability of Termination and Tolerance options for Specific Part Numbers.

*** AVX offers nonstandard chip sizes. Contact factory for details.

HIGH VOLTAGE COG CAPACITANCE VALUES

VOLTAGE	0805	1206	1210	1808	1812	1825	2220	2225	3640
600/630	min. 10pF max. 330pF	10 pF 1200 pF	100 pF 2700 pF	100 pF 3300 pF	100 pF 5600 pF	1000 pF 0.012 μF	1000 pF 0.012 μF	1000 pF 0.018 μF	1000 pF 0.047 μF
1000	min. 10pF max. 180pF	10 pF 560 pF	10 pF 1500 pF	100 pF 2200 pF	100 pF 3300 pF	100 pF 8200 pF	1000 pF 0.010 μF	1000 pF 0.010 μF	1000 pF 0.022 μF
1500	min. — max. —	10 pF 270 pF	10 pF 680 pF	10 pF 820 pF	10 pF 1800 pF	100 pF 4700 pF	100 pF 4700 pF	100 pF 5600 pF	100 pF 0.010 μF
2000	min. — max. —	10 pF 120 pF	10 pF 270 pF	10 pF 330 pF	10 pF 1000 pF	100 pF 1800 pF	100 pF 2200 pF	100 pF 2700 pF	100 pF 6800 pF
2500	min. — max. —	—	—	10 pF 180 pF	10 pF 470 pF	10 pF 1200 pF	100 pF 1500 pF	100 pF 1800 pF	100 pF 3900 pF
3000	min. — max. —	—	—	10 pF 120 pF	10 pF 330 pF	10 pF 820 pF	10 pF 1000 pF	10 pF 1200 pF	100 pF 2700 pF
4000	min. — max. —	—	—	10 pF 47 pF	10 pF 150 pF	10 pF 330 pF	10 pF 470 pF	10 pF 560 pF	100 pF 1200 pF
5000	min. — max. —	—	—	—	—	—	10 pF 220 pF	10 pF 270 pF	10 pF 820 pF

HIGH VOLTAGE X7R CAPACITANCE VALUES

VOLTAGE	0805	1206	1210	1808	1812	1825	2220	2225	3640
600/630	min. 100pF max. 6800pF	1000 pF 0.022 μF	1000 pF 0.056 μF	1000 pF 0.068 μF	1000 pF 0.120 μF	0.010 μF 0.270 μF	0.010 μF 0.270 μF	0.010 μF 0.330 μF	0.010 μF 0.560 μF
1000	min. 100pF max. 1500pF	100 pF 6800 pF	1000 pF 0.015 μF	1000 pF 0.018 μF	1000 pF 0.039 μF	1000 pF 0.100 μF	1000 pF 0.120 μF	1000 pF 0.150 μF	1000 pF 0.220 μF
1500	min. — max. —	100 pF 2700 pF	100 pF 5600 pF	100 pF 6800 pF	100 pF 0.015 μF	1000 pF 0.056 μF	1000 pF 0.056 μF	1000 pF 0.068 μF	1000 pF 0.100 μF
2000	min. — max. —	10 pF 1500 pF	100 pF 3300 pF	100 pF 3300 pF	100 pF 8200 pF	100 pF 0.022 μF	1000 pF 0.027 μF	1000 pF 0.033 μF	1000 pF 0.027 μF
2500	min. — max. —	—	—	10 pF 2200 pF	10 pF 5600 pF	100 pF 0.015 μF	100 pF 0.018 μF	100 pF 0.022 μF	1000 pF 0.022 μF
3000	min. — max. —	—	—	10 pF 1800 pF	10 pF 3900 pF	100 pF 0.010 μF	100 pF 0.012 μF	100 pF 0.015 μF	1000 pF 0.018 μF
4000	min. — max. —	—	—	—	—	—	—	—	100 pF 6800 pF
5000	min. — max. —	—	—	—	—	—	—	—	100 pF 3300 pF

Tip & Ring Tin/Lead Termination “B”

Multilayer Ceramic Chip Capacitors

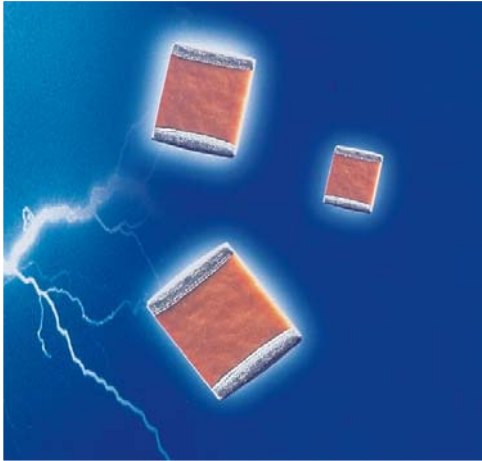

AVX Corporation will support customers for commercial and military Multilayer Ceramic Capacitors with a termination consisting of 5% minimum lead. This termination is indicated by the use of a “B” in the 12th position of the AVX Catalog Part Number. This fulfills AVX’s commitment to providing a full range of products to our customers.

AVX “Tip & Ring” or “ring detector” Multilayer Ceramic Chip Capacitors are designed as a standard telecom filter to block -48 Volts DC telephone line voltage and pass subscriber’s AC signal pulse (16 to 25Hz, 70 to 90 VRMS). The ringer capacitors replace large leaded film capacitors and are ideal for telecom/modem applications. Using AVX “Tip and Ring” capacitors not only saves valuable real estate on the board and reduces the weight of the overall product, but also features standard surface mounting capabilities, so critical to new and compact designs.

The AVX “Tip & Ring” capacitors are offered in standard EIA sizes and standard values. They offer excellent high frequency performance, low ESR and improved temperature performance over film capacitors.

Check for up-to-date CV Tables at <http://www.avx.com/docs/catalogs/apt&rb.pdf>

HOW TO ORDER

LD12	P	C	104	K	A	B	1	A
AVX Style	Voltage	Temperature Coefficient	Capacitance Code	Capacitance Tolerance	Test Level	Termination	Packaging	Special Code
LD05 - 0805 LD06 - 1206 LD10 - 1210 LD08 - 1808 LD12 - 1812 LD13 - 1825 LD20 - 2220 LD14 - 2225	250 VDC Telco Rating	X7R	(2 significant digits + no. of zeros) Examples: 1,000 pF = 102 22,000 pF = 223 220,000 pF = 224 1 μ F = 105	K = \pm 10% M = \pm 20%	A = Standard	B = 5% Min Pb X = FLEXITERM® 5% min. Pb	1 = 7" Reel 3 = 13" Reel 9 = Bulk	A = Standard

Contact factory for availability of Termination and Tolerance options for Specific Part Numbers.

PERFORMANCE CHARACTERISTICS

Capacitance Range	1000 pF to 1.2 μ F (25°C, 1.0 \pm 0.2 Vrms at 1kHz)
Capacitance Tolerances	\pm 10%, \pm 20%
Dissipation Factor	2.5% max. (25°C, 1.0 \pm 0.2 Vrms at 1kHz)
Operating Temperature Range	-55°C to +125°C
Temperature Characteristic	X7R \pm 15% (0 VDC)
Voltage Rating	250 VDC Telco rating
Insulation Resistance	1000 megohm-microfarad min.
Dielectric Strength	Minimum 200% rated voltage for 5 seconds at 50 mA max. current

CAPACITANCE RANGE (μ F)

STYLE (SIZE)	LD05 (0805)	LD06 (1206)	LD10 (1210)	LD08 (1808)	LD12 (1812)	LD13 (1825)	LD20 (2220)	LD14 (2225)
min.	0.0010	0.0010	0.0010	0.010	0.10	0.33	0.47	0.47
max.	0.027	0.082	0.22	0.27	0.47	1.0	1.0	1.2

Automotive MLCC

NP0 Dielectric

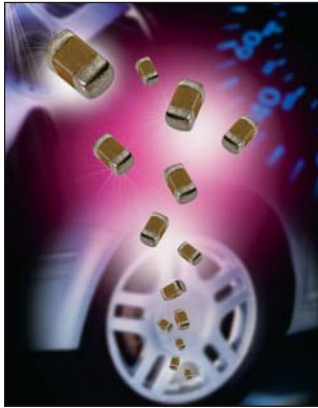

AVX Corporation has supported the Automotive Industry requirements for Multilayer Ceramic Capacitors consistently for more than 10 years. Products have been developed and tested specifically for automotive applications and all manufacturing facilities are QS9000 and VDA 6.4 approved.

As part of our sustained investment in capacity and state of the art technology, we are now transitioning from the established Pd/Ag electrode system to a Base Metal Electrode system (BME).

AVX is using AEC-Q200 as the qualification vehicle for this transition. A detailed qualification package is available on request and contains results on a range of part numbers including:

- Contains BME electrode and copper terminations with a Ni/Sn plated overcoat.
- BME electrode with epoxy finish for conductive glue mounting.
- BME electrode and soft terminations with a Ni/Sn plated overcoat.
- NP0 dielectric components containing Pd/Ag electrode and silver termination with a Ni/Sn plated overcoat.



Check for up-to-date CV Tables at
<http://www.avx.com/docs/catalogs/cauto.pdf>

HOW TO ORDER

0805

5

A

104

K

4

T

2

A

Size
 0603
 0805
 1206
 1210
 1812

Voltage
 3 = 25V
 5 = 50V
 1 = 100V
 2 = 200V
 7 = 500V

Dielectric
 NP0 = A

Capacitance Code (In pF)
 2 Significant Digits + Number of Zeros
 e.g. 10µF = 106

Capacitance Tolerance
 F = ±1% (≥10pF)
 G = ±2% (≥10pF)
 J = ±5% (≤1µF)
 K = ±10%
 M = ±20%

Failure Rate
 4 = Automotive

Terminations
 T = Plated Ni and Sn

Packaging
 2 = 7" Reel
 4 = 13" Reel

Special Code
 A = Std. Product

Contact factory for availability of Tolerance Options for Specific Part Numbers.

AUTOMOTIVE MLCC – NP0

	0603			0805			1206					1210				1812	
	25V	50V	100V	25V	50V	100V	25V	50V	100V	200V	500V	25V	50V	100V	200V	50V	100V
100 10pF	G	G	G	J	J	J	J	J	J	J	J						
120 12	G	G	G	J	J	J	J	J	J	J	J						
150 15	G	G	G	J	J	J	J	J	J	J	J						
180 18	G	G	G	J	J	J	J	J	J	J	J						
220 22	G	G	G	J	J	J	J	J	J	J	J						
270 27	G	G	G	J	J	J	J	J	J	J	J						
330 33	G	G	G	J	J	J	J	J	J	J	J						
390 39	G	G	G	J	J	J	J	J	J	J	J						
470 47	G	G	G	J	J	J	J	J	J	J	J						
510 51	G	G	G	J	J	J	J	J	J	J	J						
560 56	G	G	G	J	J	J	J	J	J	J	J						
680 68	G	G	G	J	J	J	J	J	J	J	J						
820 82	G	G	G	J	J	J	J	J	J	J	J						
101 100	G	G	G	J	J	J	J	J	J	J	J						
121 120	G	G	G	J	J	J	J	J	J	J	J						
151 150	G	G	G	J	J	J	J	J	J	J	J						
181 180	G	G	G	J	J	J	J	J	J	J	J						
221 220	G	G	G	J	J	J	J	J	J	J	J						
271 270	G	G	G	J	J	J	J	J	J	J	J						
331 330	G	G	G	J	J	J	J	J	J	J	J						
391 390	G	G	G	J	J	J	J	J	J	J	J						
471 470	G	G	G	J	J	J	J	J	J	J	J						
561 560				J	J	J	J	J	J	J	J						
681 680				J	J	J	J	J	J	J	J						
821 820				J	J	J	J	J	J	J	J						
102 1000				J	J	J	J	J	J	J	J	J	J	J	J		
122 1200							J	J	J	J	J	J	J	M	M		
152 1500							J	M	M	M	M	J	J	M	M		
182 1800							J	M	M	M	M	J	J	M	M		
222 2200							J	M	M	M	M	J	J	M	M		
272 2700							J	M	Q			J	J	M			
332 3300							J	M	Q			J	J	P		K	K
392 3900												J	J	P		K	K
472 4700												J	J	P		K	K
103 10nF																	
	25V	50V	100V	25V	50V	100V	25V	50V	100V	200V	500V	25V	50V	100V	200V	50V	100V
	0603			0805			1206					1210				1812	

Letter	A	C	E	G	J	K	M	N	P	Q	X	Y	Z
Max. Thickness	0.33 (0.013)	0.56 (0.022)	0.71 (0.028)	0.90 (0.035)	0.94 (0.037)	1.02 (0.040)	1.27 (0.050)	1.40 (0.055)	1.52 (0.060)	1.78 (0.070)	2.29 (0.090)	2.54 (0.100)	2.79 (0.110)
	PAPER					EMBOSSED							



Automotive MLCC

X7R Dielectric

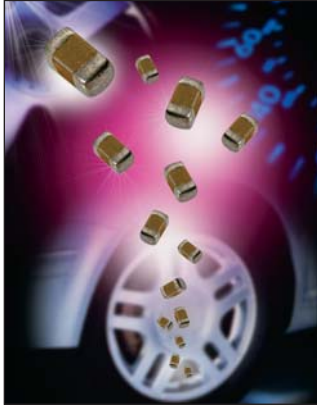

AVX Corporation has supported the Automotive Industry requirements for Multilayer Ceramic Capacitors consistently for more than 10 years. Products have been developed and tested specifically for automotive applications and all manufacturing facilities are QS9000 and VDA 6.4 approved.

As part of our sustained investment in capacity and state of the art technology, we are now transitioning from the established Pd/Ag electrode system to a Base Metal Electrode system (BME).

AVX is using AEC-Q200 as the qualification vehicle for this transition. A detailed qualification package is available on request and contains results on a range of part numbers including:

- X7R dielectric components containing BME electrode and copper terminations with a Ni/Sn plated overcoat.
- X7R dielectric components, BME electrode with epoxy finish for conductive glue mounting.
- X7R dielectric components BME electrode and soft terminations with a Ni/Sn plated overcoat.

Check for up-to-date CV Tables at <http://www.avx.com/docs/catalogs/cauto.pdf>

HOW TO ORDER

0805	5	C	104	K	4	T	2	A
Size 0402 0603 0805 1206 1210 1812 2220	Voltage Y = 16V 3 = 25V 5 = 50V 1 = 100V 2 = 200V 7 = 500V	Dielectric X7R = C	Capacitance Code (In pF) 2 Significant Digits + Number of Zeros e.g. 10µF = 106	Capacitance Tolerance J = ±5% K = ±10% M = ±20%	Failure Rate 4 = Automotive	Terminations T = Plated Ni and Sn Z = FLEXITERM® U = Conductive Epoxy	Packaging 2 = 7" Reel 4 = 13" Reel	Special Code A = Std. Product

NOTE: Contact factory for non-specified capacitance values. 0402 case size available in T termination only.
Contact factory for availability of Termination and Tolerance Options for Specific Part Numbers.

AUTOMOTIVE MLCC – X7R

	0402			0603				0805					1206					1210				1812		2220				
	16V	25V	50V	16V	25V	50V	100V	200V	16V	25V	50V	100V	200V	16V	25V	50V	100V	200V	500V	16V	25V	50V	100V	50V	100V	25V	50V	
221	Cap .22	C	C	C																								
271	(nF) .27	C	C	C																								
331	.33	C	C	C																								
391	.39	C	C	C																								
471	.47	C	C	C																								
561	.56	C	C	C																								
681	.68	C	C	C																								
821	.82	C	C	C																								
102	1	C	C	C	G	G	G	G	G	J	J	J	J	J	J	J	J	J	J	J	K	K	K	K	K	K	K	K
182	1.8	C	C	C	G	G	G	G	G	J	J	J	J	J	J	J	J	J	J	J	K	K	K	K	K	K	K	K
222	2.2	C	C	C	G	G	G	G	G	J	J	J	J	J	J	J	J	J	J	J	K	K	K	K	K	K	K	K
332	3.3	C	C	C	G	G	G	G	G	J	J	J	J	J	J	J	J	J	J	J	K	K	K	K	K	K	K	K
472	4.7	C	C	C	G	G	G	G	G	J	J	J	J	J	J	J	J	J	J	J	K	K	K	K	K	K	K	K
103	10	C			G	G	G	G	G	J	J	J	J	J	J	J	J	J	J	J	K	K	K	K	K	K	K	K
123	12				G	G	G			J	J	J	M		J	J	J	J	J		K	K	K	K	K	K	K	K
153	15				G	G	G			J	J	J	M		J	J	J	J	J		K	K	K	K	K	K	K	K
183	18				G	G	G			J	J	J	M		J	J	J	J	J		K	K	K	K	K	K	K	K
223	22				G	G	G			J	J	J	M		J	J	J	J	J		K	K	K	K	K	K	K	K
273	27				G	G	G			J	J	J	M		J	J	J	J	J		K	K	K	K	K	K	K	K
333	33				G	G	G			J	J	J	M		J	J	J	J	J		K	K	K	K	K	K	K	K
473	47				G	G	G			J	J	J	M		J	J	J	M	J		K	K	K	K	K	K	K	K
563	56				G	G	G			J	J	J	M		J	J	J	M	J		K	K	K	M	K	K	K	K
683	68				G	G	G			J	J	J	M		J	J	J	M	J		K	K	K	M	K	K	K	K
823	82				G	G	G			J	J	J	M		J	J	J	M	J		K	K	K	M	K	K	K	K
104	100				G	G	G			J	J	M	M		J	J	J	M	J		K	K	K	M	K	K	K	K
124	120									J	J	M			J	J	M	M			K	K	K	P	K	K	K	K
154	150									M	N	M			J	J	M	M			K	K	K	P	K	K	K	K
224	220									M	N	M			J	M	M	Q			M	M	M	P	M	M	M	M
334	330									N	N	M			J	M	P	Q			P	P	P	Q	X	X	X	X
474	470									N	N	M			M	M	P	Q			P	P	P	Q	X	X	X	X
684	680									N	N				M	Q	Q	Q			P	P	Q	X	X	X	X	X
105	Cap 1									N	N				M	Q	Q	Q			P	Q	Q	X	X	X	X	X
155	(µF) 1.5														Q	Q					P	Q	Z	Z	X	X	X	X
225	2.2														Q	Q					X	Z	Z	Z	Z	Z	Z	Z
335	3.3																				X	Z	Z	Z	Z	Z	Z	Z
475	4.7																				X	Z	Z	Z	Z	Z	Z	Z
106	10																											
226	22																											Z
		16V	25V	50V	16V	25V	50V	100V	200V	16V	25V	50V	100V	200V	16V	25V	50V	100V	200V	500V	16V	25V	50V	100V	50V	100V	25V	50V
		0402			0603				0805					1206					1210				1812		2220			

Letter	A	C	E	G	J	K	M	N	P	Q	X	Y	Z
Max. Thickness	0.33 (0.013)	0.56 (0.022)	0.71 (0.028)	0.90 (0.035)	0.94 (0.037)	1.02 (0.040)	1.27 (0.050)	1.40 (0.055)	1.52 (0.060)	1.78 (0.070)	2.29 (0.090)	2.54 (0.100)	2.79 (0.110)
	PAPER					EMBOSSED							

= Under development
AEC-Q200 qualified
TS 16949, ISO 9001 certified



High Voltage FLEXITERM®

AEC-Q200 X7R For 600V to 5000V Applications

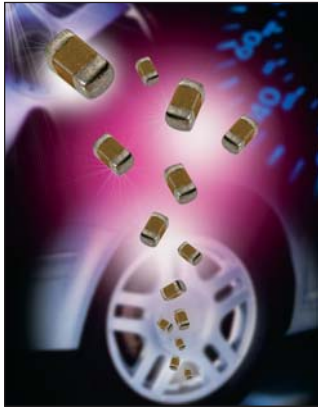

High value, low leakage and small size are difficult parameters to obtain in capacitors for high voltage systems. AVX special high voltage MLC chip capacitors meet these performance characteristics and are designed for applications such as snubbers in high frequency power converters, resonators in SMPS, and high voltage coupling/DC blocking. These high voltage chip designs exhibit low ESRs at high frequencies.

To make high voltage chips, larger physical sizes than are normally encountered are necessary. These larger sizes require that special precautions be taken in applying these chips in surface mount assemblies. In response to this, and to follow from the success of the FLEXITERM® range of low voltage parts, AVX is delighted to offer a FLEXITERM® high voltage range of capacitors, FLEXITERM®.

The FLEXITERM® layer is designed to enhance the mechanical flexure and temperature cycling performance of a standard ceramic capacitor, giving customers a solution where board flexure or temperature cycle damage are concerns.

Check for up-to-date CV Tables at <http://www.avx.com/docs/catalogs/flexitermhv.pdf>

HOW TO ORDER

1808	A	C	272	K	4	Z	1	A
AVX Style 0805 1206 1210 1808 1812 1825 2220 2225 ***	Voltage C = 600V/630V A = 1000V S = 1500V G = 2000V W = 2500V H = 3000V	Temperature Coefficient COG = A X7R = C	Capacitance Code (2 significant digits + no. of zeros) Examples: 10 pF = 100 100 pF = 101 1,000 pF = 102 22,000 pF = 223 220,000 pF = 224 1 µF = 105	Capacitance Tolerance COG: J = ±5% K = ±10% M = ±20% X7R: K = ±10% M = ±20% Z = +80%, -20%	Test Level	Termination* Z = FLEXITERM® 100% Tin (RoHS Compliant)	Packaging 1 = 7" Reel 3 = 13" Reel 9 = Bulk	Special Code A = Standard

Notes: Capacitors with X7R dielectrics are not intended for applications across AC supply mains or AC line filtering with polarity reversal. Contact plant for recommendations. Contact factory for availability of Termination and Tolerance options for Specific Part Numbers.

*** AVX offers nonstandard chip sizes. Contact factory for details.

Size	1206			1210						1812					2220	
	600/630	1000	2000	600/630	1000	1500	2000	2500	3000	600/630	1000	2000	2500	3000	600/630	1500
(pF) 100																
120																
150																
180																
220																
270																
330																
390																
470																
560																
680																
820																
1000																
1200																
1500																
1800																
2200																
2700																
3300																
3900																
4700																
5600																
6800																
8200																
0.01																
0.012																
0.015																
0.018																
0.022																
0.027																
0.033																
0.039																
0.047																
0.056																
0.068																
0.082																
(µF) 0.1																
Size	1206			1210						1812					2220	

Standard Capacitor Arrays

Standard NP0, X7R and X5R Dielectric

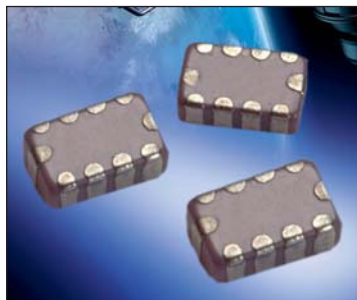

AVX is the market leader in the development and manufacture of capacitor arrays. The smallest array option available from AVX, the 0405 2-element device, has been an enormous success in the Telecommunications market. The array family of products also includes the 0612 4-element device as well as 0508 2-element and 4-element series, all of which have received widespread acceptance in the marketplace.

AVX capacitor arrays are available in X5R, X7R and NP0 (C0G) ceramic dielectrics to cover a broad range of capacitance values. Voltage ratings from 6.3 Volts up to 100 Volts are offered. AVX also now offers a range of automotive capacitor arrays qualified to AEC-Q200 (see separate table).

Key markets for capacitor arrays are Mobile and Cordless Phones, Digital Set Top Boxes, Computer Motherboards and Peripherals as well as Automotive applications, RF Modems, Networking Products, etc.

[Check for up-to-date CV Tables at
http://www.avx.com/docs/catalogs/caparray.pdf](http://www.avx.com/docs/catalogs/caparray.pdf)

HOW TO ORDER (Capacitor Array - IPC)

W ↓	2 ↓	A ↓	4 ↓	3 ↓	C ↓	103 ↓	M ↓	A ↓	T ↓	2A ↓
Style	Case Size	Array	Number of Caps	Voltage	Dielectric	Capacitance Code (In pF)	Capacitance Tolerance	Failure Rate	Terminations	Packaging & Quantity Code
W = RoHS L = Tin/Lead	1 = 0405 2 = 0508 3 = 0612 5 = 0306			6 = 6V Z = 10V Y = 16V 3 = 25V 5 = 50V 1 = 100	A = NP0 C = X7R D = X5R	2 Sig. Digits + No. of Zeros	J = ±5% K = ±10% M = ±20%	A=Commercial	T = Ni Barrier* Z = FLEXITERM®* B = 5% min lead X = FLEXITERM® with 5% min lead	2A = 7" Reel (4000) 4A = 13" Reel (10000) 2F = 7" Reel (1000)
									*RoHS compliant	

NP0/C0G

SIZE # Elements	0405				0508				0612						
	2		2		4		4		4		4				
Soldering	Reflow Only		Reflow/Wave		Reflow/Wave		Reflow/Wave		Reflow/Wave		Reflow/Wave				
Packaging	All Paper		All Paper		Paper/Embossed		Paper/Embossed		Paper/Embossed		Paper/Embossed				
Length	1.00 ± 0.15 (0.039 ± 0.006)		1.30 ± 0.15 (0.051 ± 0.006)		1.30 ± 0.15 (0.051 ± 0.006)		1.60 ± 0.150 (0.063 ± 0.006)		1.60 ± 0.150 (0.063 ± 0.006)		1.60 ± 0.150 (0.063 ± 0.006)				
Width	1.37 ± 0.15 (0.054 ± 0.006)		2.10 ± 0.15 (0.083 ± 0.006)		2.10 ± 0.15 (0.083 ± 0.006)		3.20 ± 0.20 (0.126 ± 0.006)		3.20 ± 0.20 (0.126 ± 0.006)		3.20 ± 0.20 (0.126 ± 0.006)				
Max. Thickness	0.66 (0.026)		0.94 (0.037)		0.94 (0.037)		1.35 (0.053)		1.35 (0.053)		1.35 (0.053)				
WVDC	16	25	50	16	25	50	100	16	25	50	100	16	25	50	100
1R0 1R2 1R5	1.0		1.2												
1R8 2R2 2R7	1.8		2.2		2.2										
3R3 3R9 4R7	3.3		3.9		4.7										
5R6 6R8 6R2	5.6		6.8		8.2										
100 120 150	10		12		15										
180 220 270	18		22		27										
330 390 470	33		39		47										
560 680 820	56		68		82										
101 121 151	100		120		150										
181 221 271	180		220		270										
331 391 471	330		390		470										
561 681 821	560		680		820										
102 122 152	1000		1200		1500										
182 222 272	1800		2200		2700										
332 392 472	3300		3900		4700										
562 682 822	5600		6800		8200										

X7R/X5R

SIZE # Elements	0306			0405			0508			0508			0612																	
	4			2			2			4			4																	
Soldering	Reflow Only			Reflow Only			Reflow/Wave			Reflow/Wave			Reflow/Wave																	
Packaging	All Paper			All Paper			Paper/Embossed			Paper/Embossed			Paper/Embossed																	
Length	1.60 ± 0.15 (0.063 ± 0.006)			1.00 ± 0.15 (0.039 ± 0.006)			1.30 ± 0.15 (0.051 ± 0.006)			1.30 ± 0.15 (0.051 ± 0.006)			1.60 ± 0.150 (0.063 ± 0.006)																	
Width	0.81 ± 0.15 (0.032 ± 0.006)			1.37 ± 0.15 (0.054 ± 0.006)			2.10 ± 0.15 (0.083 ± 0.006)			2.10 ± 0.15 (0.083 ± 0.006)			3.20 ± 0.20 (0.126 ± 0.006)																	
Max. Thickness	0.50 (0.020)			0.66 (0.026)			0.94 (0.037)			0.94 (0.037)			1.35 (0.053)																	
WVDC	6	10	16	25	6	10	16	25	50	6	10	16	25	50	100	6	10	16	25	50	100	6	10	16	25	50	100			
101 121 151	Cap			100			120			150																				
181 221 271	180			220			270																							
331 391 471	330			390			470																							
561 681 821	560			680			820																							
102 122 152	1000			1200			1500																							
182 222 272	1800			2200			2700																							
332 392 472	3300			3900			4700																							
562 682 822	5600			6800			8200																							
103 123 153	Cap			0.010			0.012			0.015																				
183 223 273	0.018			0.022			0.027																							
333 393 473	0.033			0.039			0.047																							
563 683 823	0.056			0.068			0.082																							
104 124 154	0.10			0.12			0.15																							
184 224 274	0.18			0.22			0.27																							
334 474 564	0.33			0.47			0.56																							
684 824 105	0.68			0.82			1.0																							
125 155 185	1.2			1.5			1.8																							
225 335 475	2.2			3.3			4.7																							
106 226 476	10			22			47																							
107	100																													

= Currently available X7R
 = Currently available X5R
 = Under development X7R, contact factory for advance samples
 = Under development X5R, contact factory for advance samples



FLEXISAFE™ MLC Chips

For Ultra Safety Critical Applications



AVX have developed a range of components specifically for safety critical applications.

Utilizing the award-winning FLEXITERM® layer in conjunction with the cascade design previously used for high voltage MLCCs, a range of ceramic capacitors is now available for customers who require components designed with an industry leading set of safety features.

The FLEXITERM® layer protects the component from any damage to the ceramic resulting from mechanical stress during PCB assembly or use with end customers. Board flexure type mechanical damage accounts for the majority of MLCC failures. The addition of the cascade structure protects the component from low insulation resistance failure resulting from other common causes for failure; thermal stress damage, repetitive strike ESD damage and placement damage. With the inclusion of the cascade design structure to complement the FLEXITERM® layer, the FLEXISAFE™ range of capacitors has unbeatable safety features.

[Check for up-to-date CV Tables at http://www.avx.com/docs/catalogs/flexisafe.pdf](http://www.avx.com/docs/catalogs/flexisafe.pdf)

HOW TO ORDER

FS03	5	C	104	K	Q	Z	2	A
Size	Voltage	Dielectric	Capacitance Code (In pF)	Capacitance Tolerance	Failure Rate	Terminations	Packaging	Special Code
FS03 = 0603 FS05 = 0805 FS06 = 1206 FS10 = 1210	Y = 16V 3 = 25V 5 = 50V 1 = 100V	X7R = C	2 Sig. Digits + Number of Zeros e.g. 10µF =106	J = ±5% K = ±10% M = ±20%	A = Commercial 4 = Automotive Q = APS	Z = FLEXITERM® X = FLEXITERM® with 5% min lead	2 = 7" Reel 4 = 13" Reel	A = Std. Product

FLEXISAFE™ X7R RANGE

Capacitance		0603				0805			1206			1210		
Code	nF	16	25	50	100	16	25	50	16	25	50	16	25	50
102	1													
182	1.8													
222	2.2													
332	3.3													
472	4.7													
103	10													
123	12													
153	15													
183	18													
223	22													
273	27													
333	33													
473	47													
563	56													
683	68													
823	82													
104	100													
124	120													
154	150													
224	220													
334	330													
474	470													

 Qualified

Automotive Capacitor Arrays

AEC-Q200 Series NP0/COG, X7R Dielectric and X8R Dielectric

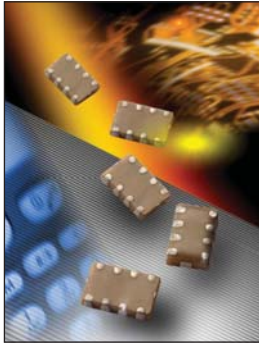

As the market leader in the development and manufacture of capacitor arrays AVX is pleased to offer a range of AEC-Q200 qualified arrays to compliment our product offering to the Automotive Industry. Both the AVX 0612 and 0508 4-element capacitor array styles are qualified to the AEC-Q200 automotive specifications.

AEC-Q200 is the Automotive Industry qualification standard and a detailed qualification package is available on request.

All AVX automotive dielectric capacitor array production facilities are certified to ISO/TS 16949:2002.

Check for up-to-date CV Tables at <http://www.avx.com/docs/catalogs/caparray.pdf>

HOW TO ORDER

W T	3 T	A T	4 T	Y T	C T	104 T	K T	4 T	T T	2A T
Style W = RoHS L = Tin/Lead	Case Size 1 = 0405 2 = 0508 3 = 0612	Array	Number of Caps	Voltage Z = 10V Y = 16V 3 = 25V 5 = 50V 1 = 100V	Dielectric A = NP0 C = X7R F = X8R	Capacitance Code (In pF) Significant Digits + Number of Zeros e.g. 10µF=106	Capacitance Tolerance *J = ±5% *K = ±10% M = ±20%	Failure Rate 4 = Automotive	Terminations T = Plated Ni and Sn** Z = FLEXITERM*** B = 5% min lead X = FLEXITERM® with 5% min lead	Packaging & Quantity Code 2A = 7" Reel (4000) 4A = 13" Reel (10000) 2F = 7" Reel (1000)

**RoHS compliant

*Contact factory for availability by part number for K = ±10% and J = ±5% tolerance.

NP0/COG											X7R											X8R						
SIZE	0405		0508		0508				0612				SIZE	0508					0508				0612		0405			
No. of Elements	2		2		4				4				No. of Elements	2					4				4		2			
WVDC	50	50	16	25	50	100	16	25	50	100	WVDC	10	16	25	50	100	16	25	50	100	10	16	25	50	100	16		
1R0 Cap 1.0 1R2 (pF) 1.2 1R5 1.5											101 Cap 100 121 (pF) 120 151 150																	
1R8 1.8 2R2 2.2 2R7 2.7											181 180 221 220 271 270																	
3R3 3.3 3R9 3.9 4R7 4.7											331 330 391 390 471 470																	
5R6 5.6 6R8 6.8 8R2 8.2											561 560 681 680 821 820																	
100 10 120 12 150 15											102 1000 122 1200 152 1500																	
180 18 220 22 270 27											182 1800 222 2200 272 2700																	
330 33 390 39 470 47											332 3300 392 3900 472 4700																	
560 56 680 68 820 82											562 5600 682 6800 822 8200																	
101 100 121 120 151 150											103 Cap 0.010 123 (µF) 0.012 153 0.015																	
181 180 221 220 271 270											183 0.018 223 0.022 273 0.027																	
331 330 391 390 471 470											333 0.033 393 0.039 473 0.047																	
561 560 681 680 821 820											563 0.056 683 0.068 823 0.082																	
102 1000 122 1200 152 1500											104 0.10 124 0.12 154 0.15																	
182 1800 222 2200 272 2700											224 0.22																	

Light Blue = NP0/COG
Dark Blue = Under development

Light Blue = X7R
Dark Blue = X8R
Blue = Under development



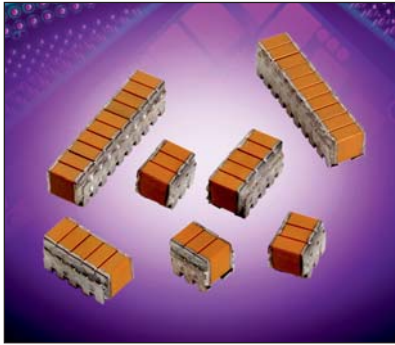

The TurboCap™, MLC capacitors from AVX Corporation are characterized with very high capacitance in a small volume. By vertical stacking of the ceramic elements, the footprint required for mounting the capacitors is greatly reduced. TurboCaps™ are ideally suited as filters in the input and output stages of switch mode power supplies (SMPS). With their ultra-low ESR, these capacitors are designed to handle high ripple current at high frequencies and high power levels. The DIP leads in either thru-hole or surface mount configurations offer superior stress relief to the ceramic elements. The leads effectively decouple the parts from the board and minimize thermally or mechanically induced stresses encountered during assembly, temperature cycling or other environmental conditions.

Check for up-to-date CV Tables at
<http://www.avx.com/docs/Catalogs/turbocap.pdf>

HOW TO ORDER

ST12	5	C	186	M	A	N	03
AVX Style ST12 ST20	Voltage 3 = 25V 5 = 50V 1 = 100V	Temperature Coefficient X7R = C	Capacitance Code (2 significant digits + no. of zeros) 1 pF = 105 10 pF = 106 100 pF = 107	Capacitance Tolerance M = ±20%	Test Level A = Standard	Termination N = Straight Lead J = Leads formed in L = Leads formed out	Number of Leads Per Side 03 = 3 05 = 5 10 = 10

CAPACITANCE (µF)

Cap (µF)	ST12		ST20			
	50V	100V	Voltage			
			25V	50V	100V	500V
.82						Development
1.3						Development
2.7						Development
8.2		...03				
12		...05				
14		Development			...03	
18	...03					
22	Development	...10			...05	
27	...05	Development		...03	Development	
47				...05	...10	
50	...10			Development	Development	
68			...03			
100	Development		...05	...10		
220			...10	Development		

Development
 Numbers inside shaded areas refer to the number of leads per side (the last two digits of the part number).

MH Series

Lead Free Ceramic Capacitor in Molded SM Leadframe



AVX is pleased to introduce the MH range of multi layer ceramic capacitors. The MH components are surface mount molded parts with a multi layer ceramic insert.

MH capacitors combine the ceramic attributes of very low ESR, non polar construction, excellent high frequency behavior, excellent voltage stress capabilities and wide temperature range; with the enhanced mechanical protection of a molded case.

The MH range provides a lead free solution to customers who have previously been unable to use large case ceramic capacitors because of mechanical stressing concerns.

Check for up-to-date CV Tables at <http://www.avx.com/docs/catalogs/mh.pdf>

HOW TO ORDER

MH T MH Series	V T Case Size	1 T MLCC Count	1 T Voltage 3 = 25V 5 = 50V 1 = 100V	C T Dielectric C = X7R	225 T Capacitance Code (In pF) 2 Sig. Digits + Number of Zeros	M T Capacitance Tolerance K = ±10% M = ±20%	A T Failure Rate A = Not Applicable	T T Terminations T = Tin Plated	2 T Packaging 2 = 7" Reel 4 = 13" Reel 6 = Waffle Pack	A T Special Code A = Standard
------------------------------------	-----------------------------------	------------------------------------	---	---	---	---	--	--	---	--

MH X7R TARGET RANGE

	Cap µF	25V	50V	100V
105	1.0			
125	1.2			
155	1.5			
185	1.8			
225	2.2			
275	2.7			
335	3.3			
395	3.9			
475	4.7			
565	5.6			
685	6.8			
825	8.2			
106	10			
126	12			
156	15			
186	18			
226	22			
276	27			
336	33			
396	39			
476	47			



LEAD-FREE
LEAD-FREE COMPATIBLE
COMPONENT

TS 16949, ISO 14001
Certified Manufacture

Leaded SMPS MLCC

SK Series for Output Filtering

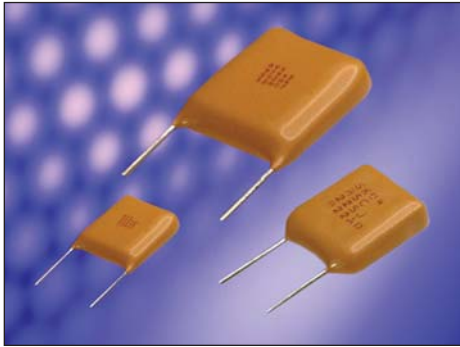

AVX SK styles are conformally coated MLC capacitors for input or output filtering in switch mode power supplies. They are specially processed to handle high currents and are low enough in cost for commercial SMPS application.

Check for up-to-date CV Tables at
<http://www.avx.com/docs/catalogs/sk.pdf>

HOW TO ORDER

SK	01	3	E	125	Z	A	A	*
Style	Size	Voltage	Temperature Coefficient	Capacitance Code	Capacitance Tolerance	Test Level	Leads	Packaging
		3 = 25V 5 = 50V 1 = 100V 2 = 200V 7 = 500V	Z5U = E X7R = C COG = A	(2 significant digits + no. of zeros) 22 nF = 223 220 nF = 224 1 μF = 105 100 μF = 107	COG: J = ±5% K = ±10% M = ±20% X7R: K = ±10% M = ±20% Z = +80, -20% Z5U: M = ±20% Z = +80, -20% P = GMV (+100, -0%)	A = Standard B = Hi-Rel*	A = Tin/Lead R = RoHS Compliant	(See Note 1)

Note 1: No suffix signifies bulk packaging, which is AVX standard packaging. SK01, SK*3, SK*4, SK*5, SK*6, SK*9 & SK*0 are available taped and reel per EIA-468. Use suffix "TR1" if tape & reel is required.

Note: Capacitors with X7R and Z5U dielectrics are not intended for applications across AC supply mains or AC line filtering with polarity reversal. Contact plant for recommendations.

*Hi-Rel screening for COG and X7R only. Screening consists of 100% Group A (B Level), Subgroup 1 per MIL-PRF-49470.

C0G Capacitance Range (μF)

Style	25 WVDC min./max.	50 WVDC min./max.	100 WVDC min./max.	200 WVDC min./max.	500 WVDC min./max.
SK01	.001/0.015	.001/0.012	.001/0.010	.0010/0.0056	.0010/0.0018
SK03/SK53	.01/0.056	.01/0.047	.01/0.039	.001/0.022	.001/0.0068
SK04/SK54	.01/0.12	.01/0.10	.01/0.082	.01/0.047	.001/0.015
SK05/SK55	.01/0.18	.01/0.15	.01/0.12	.01/0.068	.001/0.022
SK06/SK56	.10/0.56	.01/0.47	.01/0.39	.01/0.22	.01/0.068
SK07	.10/0.68	.01/0.56	.01/0.47	.01/0.27	.01/0.082
SK08	.82/1.20	.68/1.10	.56/0.82	.33/0.47	.10/0.15
SK09/SK59	.10/0.27	.01/0.22	.01/0.18	.01/0.10	.001/0.039
SK10/SK60	.10/0.68	.01/0.56	.01/0.47	.01/0.27	.01/0.082

X7R Capacitance Range (μF)

Style	25 WVDC min./max.	50 WVDC min./max.	100 WVDC min./max.	200 WVDC min./max.	500 WVDC min./max.
SK01	.01/0.39	.01/0.33	.01/0.27	.01/0.12	.001/0.047
SK03/SK53	.10/2.2	.10/1.8	.01/1.5	.01/0.56	.01/0.27
SK04/SK54	.10/4.7	.10/3.3	.10/2.7	.01/1.0	.01/0.47
SK05/SK55	.10/6.8	.10/5.6	.10/3.9	.10/1.8	.01/0.68
SK06/SK56	1.0/15	1.0/10	.10/5.6	.10/3.9	.10/1.5
SK07	1.0/18	1.0/14	1.0/8.2	.10/4.7	.10/2.2
SK08	22/33	15/22	10/15	5.6/8.2	2.2/3.9
SK09/SK59	.10/8.2	.10/5.6	.10/3.3	.10/2.2	.10/1.2
SK10/SK60	1.0/18	1.0/12	.10/6.8	.10/4.7	.10/2.2

Z5U Capacitance Range (μF)

Style	25 WVDC min./max.	50 WVDC min./max.	100 WVDC min./max.	200 WVDC min./max.
SK01	.10/1.2	.10/0.82	.10/0.47	.10/0.33
SK03/SK53	.10/5.6	.10/3.30	.10/2.20	.10/1.50
SK04/SK54	1.0/10.0	1.0/8.20	.10/4.70	.10/3.30
SK05/SK55	1.0/18.0	1.0/10.00	1.0/6.80	.10/4.70
SK06/SK56	1.0/47.0	1.0/39.00	1.0/22.00	1.0/15.00
SK07	1.0/68.0	1.0/47.00	1.0/27.00	1.0/18.00
SK08	82/120.0	56/100.00	33/47.00	22/33.00
SK09/SK59	1.0/27.0	1.0/18.00	1.0/10.00	1.0/6.80
SK10/SK60	1.0/56.0	1.0/39.00	1.0/22.00	1.0/18.00

Leaded SMPS MLCC

SE Series of Extended Ranges

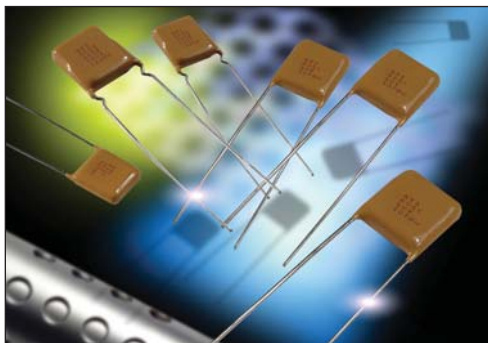

AVX SE styles offer capacitance extension to popular SK ranges. The CV product for SE-series, X7R capacitors (TCC: $\pm 15\%$ over -55 to $+125^\circ\text{C}$) compares favorably to high CV ranges offered by other suppliers in much less stable Y5U dielectric (TCC: $+22/-56\%$ over -30 to $+85^\circ\text{C}$). SE style capacitors are conformally coated and are designed for input and output filtering applications in switch mode power supplies.

 Check for up-to-date CV Tables at
<http://www.avx.com/docs/catalogs/se.pdf>

HOW TO ORDER

SE	01	3	C	125	M	A	A	*
T	T	T	T	T	T	T	T	T
Style	Size	Voltage	Temperature Coefficient	Capacitance Code	Capacitance Tolerance	Test Level	Leads	Packaging
		3 = 25V 5 = 50V 1 = 100V	X7R = C	(2 significant digits + no. of zeros) 22 nF = 223 220 nF = 224 1 μF = 105 100 μF = 107	X7R: K = $\pm 10\%$ M = $\pm 20\%$ Z = +80, -20%	A = Standard B = Hi-Rel*	A = Tin/Lead R = RoHS Compliant	(See Note 1)

Note 1: No suffix signifies bulk packaging, which is AVX standard packaging. Parts available tape and reel per EIA-468. Use suffix "TR1" if tape & reel is required.

Note: Capacitors with X7R dielectrics are not intended for applications across AC supply mains or AC line filtering with polarity reversal. Contact plant for recommendations.

*Hi-Rel screening consists of 100% Group A, Subgroup 1 per MIL-PRF-39014.

X7R Capacitance Range (μF)

Style	25 WVDC min./max.	50 WVDC min./max.	100 WVDC min./max.
SE01	0.47/1.5	0.39/1.0	0.33/0.68
SE03/SE53	2.7/6.8	2.2/4.7	1.8/3.3
SE04/SE54	5.6/12	3.9/10	3.3/6.8
SE05/SE55	8.2/18	6.8/12	4.7/10.0
SE06/SE56	18/39	12/27	6.8/15

Commercial SMT SMPS Capacitors

RH Series for I/O Filtering in DC-DC Converters

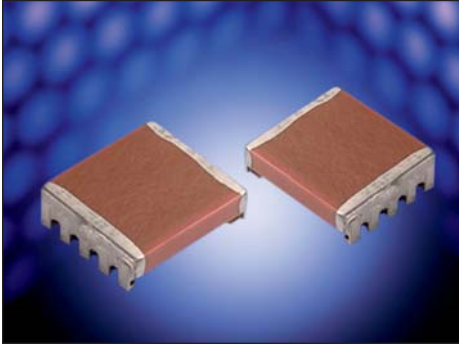

This range of uncoated MLC capacitors are processed for input and output filter capacitors in high frequency DC-DC converter applications above 10 Watts e.g. telecomms and instrumentation, where high volume and low cost is required. These products are available in surface mount 'J' lead versions and can be supplied in bulk and tape/reel packaging.

- 0.047 μF to 47.0 μF
- 25V to 500 VDC
- -55°C to +125°C
- Low ESR/ESL
- X7R Dielectric

Check for up-to-date CV Tables at <http://www.avx.com/docs/catalogs/rh.pdf>

HOW TO ORDER

RH	31	5	C	225	M	A	3	0	A	3
Style Code	Size Code	Voltage Code	Dielectric Code	Capacitance Code	Capacitance Tolerance	Specification Code	Package Code	Lead Dia. Code	Lead Space Code	Lead Style Code
		3 = 25V 5 = 50V 1 = 100V 2 = 200V 7 = 500V	C = X7R	2 Sig. Digits + Number of Zeros Examples: 105 = 1 μF 104 = 0.1 μF	K = $\pm 10\%$ M = $\pm 20\%$	A = Non customized	3 = Waffle Pack A = Tape & Reel	0 = Standard R = RoHS Compliant	A = Standard	3 = 'J' Lead

X7R Stable Dielectric

Cap μF	RH21/RH22 Style				RH31/RH32 Style				RH41/RH42 Style				RH51/RH52 Style				RH61/RH62 Style					
	25	50	100	200	500	50	100	200	500	50	100	200	500	50	100	200	500	50	100	200	500	
0.047																						
0.056																						
0.068																						
0.082																						
0.1																						
0.12																						
0.15																						
0.18																						
0.22																						
0.27																						
0.33																						
0.39																						
0.47																						
0.56																						
0.68																						
0.78																						
0.82																						
1																						
1.2																						
1.5																						
1.8																						
2.2																						
2.7																						
3																						
3.3																						
3.9																						
4.4																						
4.7																						
5.6																						
6.8																						
8.2																						
10																						
12																						
15																						
18																						
22																						
27																						
33																						
39																						
47																						

For availability of further parts in the RH21/RH22 Series, contact manufacturing.

Stacked Leaded MLC Capacitors

SM Series

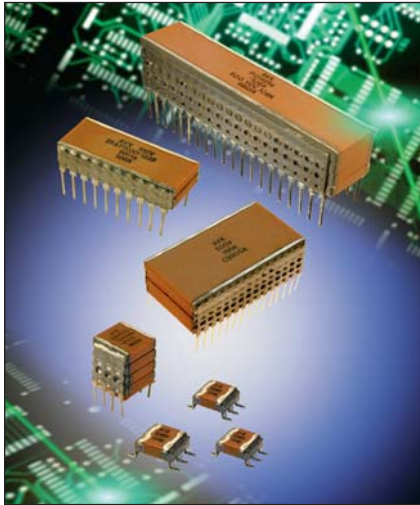

The SMPS capacitors are designed for high current, high-power and high-temperature applications. These capacitors have very low ESR (Equivalent Series Resistance) and ESL (Equivalent Series Inductance). SMPS Series capacitors offer design and component engineers a proven technology specifically designed for programs requiring high reliability performance in harsh environments.

Check for up-to-date CV Tables at <http://www.avx.com/docs/catalogs/rm01-06.pdf>

HOW TO ORDER AVX Styles: SM-1, SM-2, SM-3, SM-4, SM-5, SM-6

SM0	1	7	C	106	M	A	N	650
AVX Style Size SM0 = Uncoated SM5 = Epoxy Coated	Size	Voltage 5 = 50V 1 = 100V 2 = 200V 7 = 500V	Temperature Coefficient COG = A X7R = C	Capacitance Code (2 significant digits + no. of zeros) 10 pF = 100 100 pF = 101 1,000 pF = 102 22,000 pF = 223 220,000 pF = 224 1 μF = 105 10 μF = 106 100 μF = 107	Capacitance Tolerance COG: J = ±5% K = ±10% M = ±20% X7R: K = ±10% M = ±20% Z = +80%, -20%	Test Level A = Standard	Termination N = Straight Lead J = Leads formed in L = Leads formed out P = P Style Leads Z = Z Style Leads	Height Max Dimension "A" 120 = 0.120" 240 = 0.240" 360 = 0.360" 480 = 0.480" 650 = 0.650"

Note: Capacitors with X7R and Z5U dielectrics are not intended for applications across AC supply mains or AC line filtering with polarity reversal. Contact plant for recommendations.

CAPABILITY

Case code	Voltage	X7R Cap range Min μF	X7R Cap range Max μF	Tolerances	Configurations
5	50	1.2	5.4	10 & 20%	N, J, L Leads
	100	0.68	3.3	10 & 20%	N, J, L Leads
	200	0.47	1.5	10 & 20%	N, J, L Leads
	500	0.15	0.68	10 & 20%	N, J, L Leads
4	50	6.8	15.0	10 & 20%	N, J, L Leads
	100	3.9	8.2	10 & 20%	N, J, L Leads
	200	1.8	3.9	10 & 20%	N, J, L Leads
	500	0.8	1.8	10 & 20%	N, J, L Leads
3	50	18.0	47.0	10 & 20%	N, J, L Leads
	100	10.0	27.0	10 & 20%	N, J, L Leads
	200	4.7	12.0	10 & 20%	N, J, L Leads
	500	2.5	5.4	10 & 20%	N, J, L Leads
2	50	120.0	150.0	10 & 20%	N, J, L Leads
	100	68.0	82.0	10 & 20%	N, J, L Leads
	200	33.0	39.0	10 & 20%	N, J, L Leads
	500	15.0	18.0	10 & 20%	N, J, L Leads
1	50	56.0	100.0	10 & 20%	N, J, L Leads
	100	33.0	56.0	10 & 20%	N, J, L Leads
	200	15.0	27.0	10 & 20%	N, J, L Leads
	500	6.8	12.0	10 & 20%	N, J, L Leads
6	50	180.0	270.0	10 & 20%	N, J, L Leads
	100	100.0	180.0	10 & 20%	N, J, L Leads
	200	47.0	120.0	10 & 20%	N, J, L Leads
	500	22.0	39.0	10 & 20%	N, J, L Leads

Stacked Leaded MLC Capacitors

RM Series

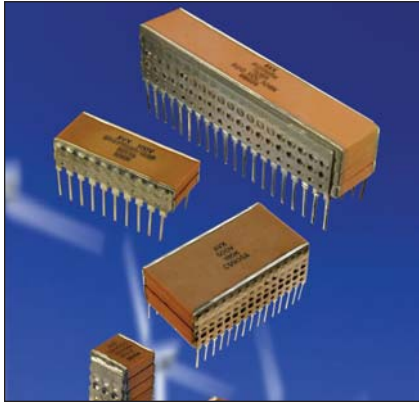

The SMPS capacitors are designed for high current, high-power and high-temperature applications. These capacitors have very low ESR (Equivalent Series Resistance) and ESL (Equivalent Series Inductance). SMPS Series capacitors offer design and component engineers a proven technology specifically designed for programs requiring high reliability performance in harsh environments.

Check for up-to-date CV Tables at <http://www.avx.com/docs/catalogs/rm01-06.pdf>

HOW TO ORDER AVX Styles: RM-1, RM-2, RM-3, RM-4, RM-5, RM-6

RM0	1	7	C	106	M	A	N	650
AVX Style Size	Size	Voltage	Temperature Coefficient	Capacitance Code (2 significant digits + no. of zeros)	Capacitance Tolerance	Test Level	Termination	Height
RM0 = Uncoated RM5 = Epoxy Coated	5 = 50V 1 = 100V 2 = 200V 7 = 500V	COG = A X7R = C	COG = A X7R = C	10 pF = 100 100 pF = 101 1,000 pF = 102 22,000 pF = 223 220,000 pF = 224 1 μF = 105 10 μF = 106 100 μF = 107	COG: J = ±5% K = ±10% M = ±20% X7R: K = ±10% M = ±20% Z = +80%, -20%	A = Standard	N = Straight Lead J = Leads formed in L = Leads formed out P = P Style Leads Z = Z Style Leads	Max Dimension "A" 120 = 0.120" 240 = 0.240" 360 = 0.360" 480 = 0.480" 650 = 0.650"

Note: Capacitors with X7R and Z5U dielectrics are not intended for applications across AC supply mains or AC line filtering with polarity reversal. Contact plant for recommendations.



CAPABILITY

Case code	Voltage	X7R Cap range Min μF	X7R Cap range Max μF	Tolerances	Configurations
5	50	1.2	5.4	10 & 20%	N, J, L Leads
	100	0.68	3.3	10 & 20%	N, J, L Leads
	200	0.47	1.5	10 & 20%	N, J, L Leads
	500	0.15	0.68	10 & 20%	N, J, L Leads
4	50	6.8	15.0	10 & 20%	N, J, L Leads
	100	3.9	8.2	10 & 20%	N, J, L Leads
	200	1.8	3.9	10 & 20%	N, J, L Leads
	500	0.8	1.8	10 & 20%	N, J, L Leads
3	50	18.0	47.0	10 & 20%	N, J, L Leads
	100	10.0	27.0	10 & 20%	N, J, L Leads
	200	4.7	12.0	10 & 20%	N, J, L Leads
	500	2.5	5.4	10 & 20%	N, J, L Leads
2	50	120.0	150.0	10 & 20%	N, J, L Leads
	100	68.0	82.0	10 & 20%	N, J, L Leads
	200	33.0	39.0	10 & 20%	N, J, L Leads
	500	15.0	18.0	10 & 20%	N, J, L Leads
1	50	56.0	100.0	10 & 20%	N, J, L Leads
	100	33.0	56.0	10 & 20%	N, J, L Leads
	200	15.0	27.0	10 & 20%	N, J, L Leads
	500	6.8	12.0	10 & 20%	N, J, L Leads
6	50	180.0	270.0	10 & 20%	N, J, L Leads
	100	100.0	180.0	10 & 20%	N, J, L Leads
	200	47.0	120.0	10 & 20%	N, J, L Leads
	500	22.0	39.0	10 & 20%	N, J, L Leads

SMPS Stacked MLC Capacitors

SM9 Style Encapsulated in DAP (Diallyl Phthalate) Case

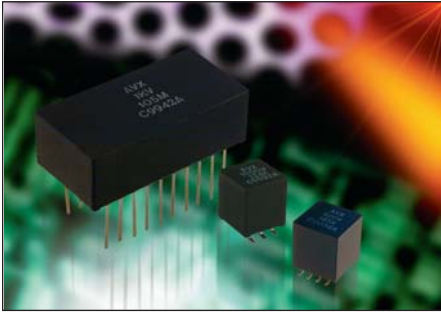

As the world's leading manufacturer and innovator in application specific multilayer ceramic (ASMLC) capacitors, AVX offers a unique technological and production capability to the field. AVX actively pursues and satisfies the high reliability and custom needs of a variety of governmental and industrial customers. Successful involvement in missile programs, extensive work in ultra-high reliability telecommunications and sophisticated capacitor design applications – all have established AVX as the source for advanced and high reliability ASMLC capacitors. **Advanced Products are ISO9001 certified organizations for design and manufacturing of MLC capacitors.**

Check for up-to-date CV Tables at
<http://www.avx.com/docs/catalogs/sm9.pdf>

HOW TO ORDER AVX Styles: SM91, SM92, SM93, SM94, SM95, SM96

SM9	1	7	C	106	M	A	N	650
AVX Style SM9 = Plastic Case	Size	Voltage 5 = 50V 1 = 100V 2 = 200V 7 = 500V	Temperature Coefficient C0G = A X7R = C Z5U = E	Capacitance Code (2 significant digits + number of zeros) 10 pF = 100 100 pF = 101 1,000 pF = 102 22,000 pF = 223 220,000 pF = 224 1 μF = 105 10 μF = 106 100 μF = 107	Capacitance Tolerance C0G: J = ±5% K = ±10% M = ±20% X7R: K = ±10% M = ±20% Z = +80%, -20% Z5U: Z = +80%, -20% P = GMV (+100, -0%)	Test Level A = Standard B = Hi-Rel*	Termination N = Straight Lead J = Leads formed in L = Leads formed out	Height Max Dimension "A" 270 = 0.270" 390 = 0.390" 530 = 0.530" 660 = 0.660" 800 = 0.800"

Note: Capacitors with X7R and Z5U dielectrics are not intended for applications across AC supply mains or AC line filtering with polarity reversal. Contact plant for recommendations.

*Hi-Rel screening for C0G and X7R only. Screening consists of 100% Group A (B Level), Subgroup 1 per MIL-PRF-49470.

Low Inductance Capacitors (RoHS)

LICC 0612/0508/0306/0204 LICC (Low Inductance Chip Capacitors)

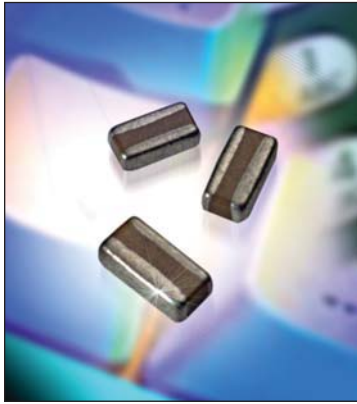

The key physical characteristic determining equivalent series inductance (ESL) of a capacitor is the size of the current loop it creates. The smaller the current loop, the lower the ESL.

A standard surface mount MLCC is rectangular in shape with electrical terminations on its shorter sides. A Low Inductance Chip Capacitor (LICC) sometimes referred to as Reverse Geometry Capacitor (RGC) has its terminations on the longer sides of its rectangular shape. The image on the right shows the termination differences between an MLCC and an LICC.

When the distance between terminations is reduced, the size of the current loop is reduced. Since the size of the current loop is the primary driver of inductance, an 0306 with a smaller current loop has significantly lower ESL than an 0603. The reduction in ESL varies by EIA size, however, ESL is typically reduced 60% or more with an LICC versus a standard MLCC.

AVX LICC products are available with a lead-free finish of plated Nickel/Tin.

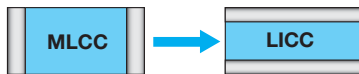

Check for up-to-date CV Tables at <http://www.avx.com/docs/catalogs/licc.pdf>

HOW TO ORDER

0612	Z	D	105	M	A	T	2	A
Size 0204 0306 0508 0612	Voltage 4 = 4V 6 = 6.3V Z = 10V Y = 16V 3 = 25V 5 = 50V	Dielectric C = X7R D = X5R W = X6S Z = X7S	Capacitance Code (In pF) 2 Sig. Digits + Number of Zeros	Capacitance Tolerance K = ±10% M = ±20%	Failure Rate A = N/A	Terminations T = Plated Ni and Sn	Packaging Available 2 = 7" Reel 4 = 13" Reel	Thickness Thickness mm (in.) 0.35 (0.014) 0.56 (0.022) 0.61 (0.024) 0.76 (0.030) 1.02 (0.040) 1.27 (0.050)

NOTE: Contact factory for availability of Termination and Tolerance Options for Specific Part Numbers.

SIZE	0204				0306					0508					0612							
	WVDC	4	6.3	10	16	4	6.3	10	16	25	50	6.3	10	16	25	50	6.3	10	16	25	50	
CAP	0.001																					
(µF)	0.0022																					
	0.0047																					
	0.010																					
	0.015																					
	0.022																					
	0.047																					
	0.068																					
	0.10																					
	0.15																					
	0.22																					
	0.47																					
	0.68																					
	1.0																					
	1.5																					
	2.2																					
	3.3																					
	4.7																					
	10																					

Solid = X7R

= X5R

= X7S

= X6S

mm (in.)

0204	
Code	Thickness
C	0.35 (0.014)

mm (in.)

0306	
Code	Thickness
A	0.61 (0.024)

mm (in.)

0508	
Code	Thickness
S	0.56 (0.022)
V	0.76 (0.030)
A	1.02 (0.040)

mm (in.)

0612	
Code	Thickness
S	0.56 (0.022)
V	0.76 (0.030)
W	1.02 (0.040)
A	1.27 (0.050)



Low Inductance Capacitors (Tin/Lead)

LICC 0612/0508/0306 Tin/Lead Termination "B"

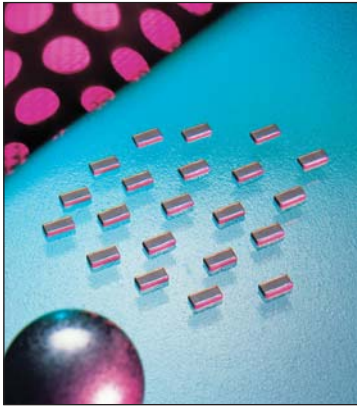

The key physical characteristic determining equivalent series inductance (ESL) of a capacitor is the size of the current loop it creates. The smaller the current loop, the lower the ESL.

A standard surface mount MLCC is rectangular in shape with electrical terminations on its shorter sides. A Low Inductance Chip Capacitor (LICC) sometimes referred to as Reverse Geometry Capacitor (RGC) has its terminations on the longer sides of its rectangular shape. The image on the right shows the termination differences between an MLCC and an LICC.

When the distance between terminations is reduced, the size of the current loop is reduced. Since the size of the current loop is the primary driver of inductance, an 0306 with a smaller current loop has significantly lower ESL than an 0603. The reduction in ESL varies by EIA size, however, ESL is typically reduced 60% or more with an LICC versus a standard MLCC.

AVX LICC products are available with a lead termination for high reliability military and aerospace applications that must avoid tin whisker reliability issues.

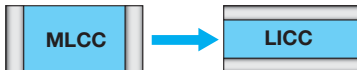

Check for up-to-date CV Tables at <http://www.avx.com/docs/catalogs/licc.pdf>

HOW TO ORDER

LD18	Z	D	105	M	A	B	2	A
Size LD15 = 0204 LD16 = 0306 LD17 = 0508 LD18 = 0612	Voltage 4 = 4V 6 = 6.3V Z = 10V Y = 16V 3 = 25V 5 = 50V	Dielectric C = X7R D = X5R W = X6S	Capacitance Code (In pF) 2 Sig. Digits + Number of Zeros	Capacitance Tolerance K = ±10% M = ±20%	Failure Rate A = N/A	Terminations B = 5% min lead	Packaging Available 2 = 7" Reel 4 = 13" Reel	Thickness mm (in) 0.35 (0.014) 0.56 (0.022) 0.61 (0.024) 0.76 (0.030) 1.02 (0.040) 1.27 (0.050)

NOTE: Contact factory for availability of Termination and Tolerance Options for Specific Part Numbers.

SIZE	LD15				LD16					LD17					LD18						
	WVDC	4	6.3	10	16	4	6.3	10	16	25	50	6.3	10	16	25	50	6.3	10	16	25	50
Cap 1000 (pF)						A	A	A	A	A	S	S	S	S	V	S	S	S	S	S	V
Cap 2200 (pF)						A	A	A	A	A	S	S	S	S	V	S	S	S	S	S	V
Cap 4700 (pF)						A	A	A	A	A	S	S	S	S	V	S	S	S	S	S	V
Cap 0.010 (µF)						A	A	A	A	A	S	S	S	S	V	S	S	S	S	S	V
Cap 0.015 (µF)						A	A	A	A	A	S	S	S	S	V	S	S	S	S	S	W
Cap 0.022 (µF)						A	A	A	A	A	S	S	S	S	V	S	S	S	S	S	W
0.047						A	A	A	A	A	S	S	S	S	V	A	S	S	S	S	W
0.068						A	A	A	A	A	S	S	S	S	V	A	S	S	S	S	W
0.10		C	C			A	A	A	A	A	S	S	S	V	A	S	S	S	S	V	W
0.15						A	A				S	S	V			S	S	S	S	W	W
0.22						A	A				S	S	A			S	S	V			
0.47						A	A				V	V	A			S	S	V			
0.68											A	A				V	V	W			
1.0											A	A				V	V	W	A		
1.5											A	A				W	W				
2.2																A	A				
3.3																A	A				
4.7																					
10																					
WVDC	4	6.3	10	16	4	6.3	10	16	25	50	6.3	10	16	25	50	6.3	10	16	25	50	
SIZE	0204				0306					0508					0612						

Solid = X7R
 = X5R
 = X7S
 = X6S

mm (in.)		mm (in.)	
0204		0306	
Code	Thickness	Code	Thickness
C	0.35 (0.014)	A	0.61 (0.024)
mm (in.)		mm (in.)	
0508		0612	
Code	Thickness	Code	Thickness
S	0.56 (0.022)	S	0.56 (0.022)
V	0.76 (0.030)	V	0.76 (0.030)
A	1.02 (0.040)	W	1.02 (0.040)
		A	1.27 (0.050)

IDC Low Inductance Capacitors (RoHS)

0612/0508 Interdigitated Capacitors



Inter-Digitated Capacitors (IDCs) are used for both semiconductor package and board level decoupling. The equivalent series inductance (ESL) of a single capacitor or an array of capacitors in parallel determines the response time of a Power Delivery Network (PDN). A designer can use many standard MLCCs in parallel to reduce ESL or a low ESL Inter-Digitated Capacitor (IDC) device.

IDCs are typically used on packages of semiconductor products with power levels of 15 watts or greater. Inter-Digitated Capacitors are used on CPU, GPU, ASIC, and ASSP devices produced on 0.13μ, 90nm, 65nm, and 45nm processes. IDC devices are used on both ceramic and organic package substrates. These low ESL surface mount capacitors can be placed on the bottom side or the top side of a package substrate.

IDCs are used for board level decoupling of systems with speeds of 300MHz or greater. Low ESL IDCs free up valuable board space by reducing the number of capacitors required versus standard MLCCs. There are additional benefits to reducing the number of capacitors beyond saving board space including higher reliability from a reduction in the number of components and lower placement costs based on the need for fewer capacitors.

Check for up-to-date CV Tables at <http://www.avx.com/docs/catalogs/w2lw3l.pdf>

HOW TO ORDER

W	3	L	1	6	D	225	M	A	T	3	A
Style	IDC Case Size	Low Inductance	Number of Terminals	Voltage	Dielectric	Capacitance Code (In pF)	Capacitance Tolerance	Failure Rate	Terminations	Packaging Available	Thickness
	2 = 0508 3 = 0612		1 = 8 Terminals	4 = 4V 6 = 6.3V Z = 10V Y = 16V 3 = 25V	C = X7R D = X5R Z = X7S	2 Sig. Digits + Number of Zeros	M = ±20%	A = N/A	T = Plated Ni and Sn	1 = 7" Reel 3 = 13" Reel	mm (in.) A = 0.95 (0.037) S = 0.55 (0.022)

NOTE: Contact factory for availability of Termination and Tolerance Options for Specific Part Numbers.

SIZE	Thin 0508				0508				Thin 0612				0612						
Length	MM	2.03 ± 0.20				2.03 ± 0.20				3.20 ± 0.20				3.20 ± 0.20					
	(in.)	(0.080 ± 0.008)				(0.080 ± 0.008)				(0.126 ± 0.008)				(0.126 ± 0.008)					
Width	MM	1.27 ± 0.20				1.27 ± 0.20				1.60 ± 0.20				1.60 ± 0.20					
	(in.)	(0.050 ± 0.008)				(0.050 ± 0.008)				(0.063 ± 0.008)				(0.063 ± 0.008)					
Terminal Pitch	MM	0.50 ± 0.05				0.50 ± 0.05				0.80 ± 0.10				0.80 ± 0.10					
	(in.)	(0.020 ± 0.002)				(0.020 ± 0.002)				(0.031 ± 0.004)				(0.031 ± 0.004)					
Thickness	MM	0.55 MAX.				0.95 MAX.				0.55 MAX.				0.95 MAX.					
	(in.)	(0.022) MAX.				(0.037) MAX.				(0.022) MAX.				(0.037) MAX.					
WDC		4	6.3	10	16	25	4	6.3	10	16	25	4	6.3	10	16	4	6.3	10	16
Cap (μF)	0.01																		
	0.033																		
	0.047																		
	0.068																		
	0.10																		
	0.22																		
	0.33																		
	0.47																		
	0.68																		
	1.0																		
	1.5																		
	2.2																		
	3.3																		



Consult factory for additional requirements

- = X7R
- = X5R
- = X7S

IDC Low Inductance Capacitors (Tin/Lead)

0612/0508 Interdigitated Capacitors

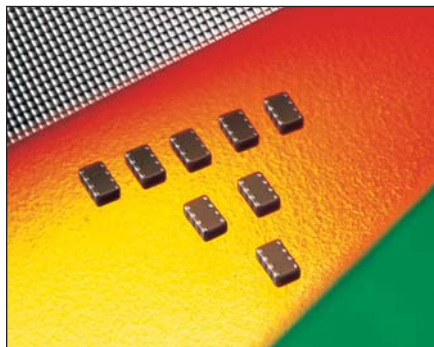

Inter-Digitated Capacitors (IDCs) are used for both semiconductor package and board level decoupling. The equivalent series inductance (ESL) of a single capacitor or an array of capacitors in parallel determines the response time of a Power Delivery Network (PDN). A designer can use many standard MLCCs in parallel to reduce ESL or a low ESL Inter-Digitated Capacitor (IDC) device.

IDCs are typically used on packages of semiconductor products with power levels of 15 watts or greater. Inter-Digitated Capacitors are used on CPU, GPU, ASIC, and ASSP devices produced on 0.13μ, 90nm, 65nm, and 45nm processes. IDC devices are used on both ceramic and organic package substrates. These low ESL surface mount capacitors can be placed on the bottom side or the top side of a package substrate.

IDCs are used for board level decoupling of systems with speeds of 300MHz or greater. Low ESL IDCs free up valuable board space by reducing the number of capacitors required versus standard MLCCs. There are additional benefits to reducing the number of capacitors beyond saving board space including higher reliability from a reduction in the number of components and lower placement costs based on the need for fewer capacitors.

Check for up-to-date CV Tables at <http://www.avx.com/docs/catalogs/I2I-I3I.pdf>

HOW TO ORDER

L	3	L	1	6	D	225	M	A	B	3	A
Style	IDC Case Size	Low Inductance	Number of Terminals	Voltage	Dielectric	Capacitance Code (In pF)	Capacitance Tolerance	Failure Rate	Terminations	Packaging Available	Thickness Max. Thickness
	2 = 0508 3 = 0612		1 = 8 Terminals	4 = 4V 6 = 6.3V Z = 10V Y = 16V 3 = 25V	C = X7R D = X5R Z = X7S	2 Sig. Digits + Number of Zeros	M = ±20%	A = N/A	B = 5% min. Lead	1 = 7" Reel 3 = 13" Reel	mm (in.) A = 0.95 (0.037) S = 0.55 (0.022)

NOTE: Contact factory for availability of Termination and Tolerance Options for Specific Part Numbers.

SIZE	Thin 0508					0508					Thin 0612				0612					
	MM (in.)	2.03 ± 0.20 (0.080 ± 0.008)	2.03 ± 0.20 (0.080 ± 0.008)	2.03 ± 0.20 (0.080 ± 0.008)	2.03 ± 0.20 (0.080 ± 0.008)	2.03 ± 0.20 (0.080 ± 0.008)	3.20 ± 0.20 (0.126 ± 0.008)	3.20 ± 0.20 (0.126 ± 0.008)	3.20 ± 0.20 (0.126 ± 0.008)	3.20 ± 0.20 (0.126 ± 0.008)	3.20 ± 0.20 (0.126 ± 0.008)	3.20 ± 0.20 (0.126 ± 0.008)	3.20 ± 0.20 (0.126 ± 0.008)	3.20 ± 0.20 (0.126 ± 0.008)	3.20 ± 0.20 (0.126 ± 0.008)					
Length	MM (in.)	2.03 ± 0.20 (0.080 ± 0.008)	2.03 ± 0.20 (0.080 ± 0.008)	2.03 ± 0.20 (0.080 ± 0.008)	2.03 ± 0.20 (0.080 ± 0.008)	2.03 ± 0.20 (0.080 ± 0.008)	3.20 ± 0.20 (0.126 ± 0.008)	3.20 ± 0.20 (0.126 ± 0.008)	3.20 ± 0.20 (0.126 ± 0.008)	3.20 ± 0.20 (0.126 ± 0.008)	3.20 ± 0.20 (0.126 ± 0.008)	3.20 ± 0.20 (0.126 ± 0.008)	3.20 ± 0.20 (0.126 ± 0.008)	3.20 ± 0.20 (0.126 ± 0.008)	3.20 ± 0.20 (0.126 ± 0.008)					
Width	MM (in.)	1.27 ± 0.20 (0.050 ± 0.008)	1.27 ± 0.20 (0.050 ± 0.008)	1.27 ± 0.20 (0.050 ± 0.008)	1.27 ± 0.20 (0.050 ± 0.008)	1.27 ± 0.20 (0.050 ± 0.008)	1.60 ± 0.20 (0.063 ± 0.008)	1.60 ± 0.20 (0.063 ± 0.008)	1.60 ± 0.20 (0.063 ± 0.008)	1.60 ± 0.20 (0.063 ± 0.008)	1.60 ± 0.20 (0.063 ± 0.008)	1.60 ± 0.20 (0.063 ± 0.008)	1.60 ± 0.20 (0.063 ± 0.008)	1.60 ± 0.20 (0.063 ± 0.008)	1.60 ± 0.20 (0.063 ± 0.008)					
Terminal Pitch	MM (in.)	0.50 ± 0.05 (0.020 ± 0.002)	0.50 ± 0.05 (0.020 ± 0.002)	0.50 ± 0.05 (0.020 ± 0.002)	0.50 ± 0.05 (0.020 ± 0.002)	0.50 ± 0.05 (0.020 ± 0.002)	0.80 ± 0.10 (0.031 ± 0.004)	0.80 ± 0.10 (0.031 ± 0.004)	0.80 ± 0.10 (0.031 ± 0.004)	0.80 ± 0.10 (0.031 ± 0.004)	0.80 ± 0.10 (0.031 ± 0.004)	0.80 ± 0.10 (0.031 ± 0.004)	0.80 ± 0.10 (0.031 ± 0.004)	0.80 ± 0.10 (0.031 ± 0.004)	0.80 ± 0.10 (0.031 ± 0.004)					
Thickness	MM (in.)	0.55 MAX. (0.022) MAX.	0.55 MAX. (0.022) MAX.	0.55 MAX. (0.022) MAX.	0.55 MAX. (0.022) MAX.	0.55 MAX. (0.022) MAX.	0.95 MAX. (0.037) MAX.	0.95 MAX. (0.037) MAX.	0.95 MAX. (0.037) MAX.	0.95 MAX. (0.037) MAX.	0.95 MAX. (0.037) MAX.	0.95 MAX. (0.037) MAX.	0.95 MAX. (0.037) MAX.	0.95 MAX. (0.037) MAX.	0.95 MAX. (0.037) MAX.					
WVDC		4	6.3	10	16	25	4	6.3	10	16	25	4	6.3	10	16	4	6.3	10	16	
Cap (μF)	0.01																			
	0.033																			
	0.047																			
	0.068																			
	0.10																			
	0.22																			
	0.33																			
	0.47																			
	0.68																			
	1.0																			
	1.5																			
	2.2																			
	3.3																			

Consult factory for additional requirements

- = X7R
- = X5R
- = X7S

LGA Low Inductance Capacitors

0204/0306/0805 Land Grid Arrays



Land Grid Array (LGA) capacitors are the latest family of low inductance MLCCs from AVX. These new LGA products are the third low inductance family developed by AVX. The innovative LGA technology sets a new standard for low inductance MLCC performance. *Electronic Products* awarded its 2006 Product of the Year Award to the LGA Decoupling capacitor.

Our initial 2 terminal versions of LGA technology deliver the performance of an 8 terminal IDC low inductance MLCC with a number of advantages including:

- Simplified layout of 2 large solder pads compared to 8 small pads for IDCs
- Opportunity to reduce PCB or substrate contribution to system ESL by using multiple parallel vias in solder pads
- Advanced FCT manufacturing process used to create uniformly flat terminations on the capacitor that resist “tombstoning”
- Better solder joint reliability

 Check for up-to-date CV Tables at
<http://www.avx.com/docs/catalogs/lga2t.pdf>

APPLICATIONS

Semiconductor Packages

- Microprocessors/CPUs
- Graphics Processors/GPUs
- Chipsets
- FPGAs
- ASICs

Board Level Device Decoupling

- Frequencies of 300 MHz or more
- ICs drawing 15W or more
- Low voltages
- High speed buses

HOW TO ORDER

LG	1	2	6	Z	104	M	A	T	2	S	1
Style	Case Size	Number of Terminals	Working Voltage	Temperature Characteristic	Coded Cap	Cap Tolerance	Termination Style	Termination	Packaging Tape & Reel	Thickness	Number of Capacitors
	1 = 0204 2 = 0306 C = 0805	2	4 = 4V 6 = 6.3V Z = 10V	C = X7R D = X5R Z = X7S W = X6S		M = 20%	A = “U” Land	100% Sn* <small>*Contact factory for other termination finishes</small>	2 = 7” Reel 4 = 13” Reel	S = 0.55mm max	

SIZE	LG12 (0204)						LG22 (0306)						LGC2 (0805)										
Length mm (in.)	0.50 (0.020)						0.76 (0.030)						2.06 (0.081)										
Width mm (in.)	1.00 (0.039)						1.60 (0.063)						1.32 (0.052)										
Temp. Char.	X5R (D)		X7S (Z)		X6S (W)		X7R (C)		X5R (D)		X7S (Z)		X6S (W)		X7R (C)		X5R (D)		X7S (Z)		X6S (W)		
Working Voltage	6.3 (6)	4 (4)	6.3 (6)	4 (4)	6.3 (6)	4 (4)	10 (Z)	6.3 (6)	4 (4)	6.3 (6)	4 (4)	6.3 (6)	4 (4)	6.3 (6)	4 (4)	6.3 (6)	4 (4)	6.3 (6)	4 (4)	6.3 (6)	4 (4)	6.3 (6)	4 (4)
Cap (µF)	0.010 (103)																						
	0.022 (223)																						
	0.047 (473)																						
	0.100 (104)																						
	0.220 (224)																						
	0.330 (334)																						
	0.470 (474)																						
	1.000 (105)																						
	2.200 (225)																						

= X7R
 = X5R
 = X7S
 = X6S

Please contact AVX for values



Low Inductance Capacitors

LICA® (Low Inductance Decoupling Capacitor Arrays)

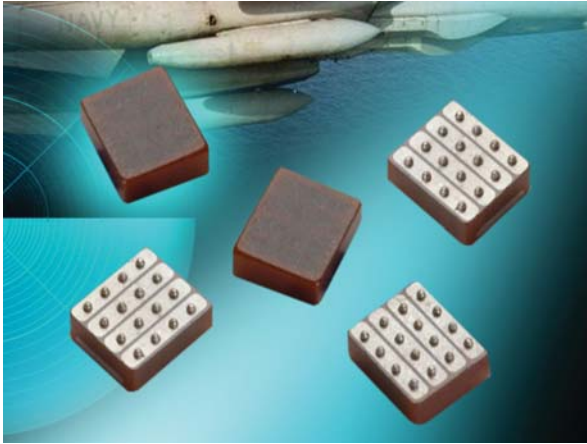

LICA® arrays utilize up to four separate capacitor sections in one ceramic body. These designs exhibit a number of technical advancements:

Low Inductance features–

- Low resistance platinum electrodes in a low aspect ratio pattern
- Double electrode pickup and perpendicular current paths
- C4 “flip-chip” technology for minimal interconnect inductance

Check for up-to-date CV Tables at
<http://www.avx.com/docs/catalogs/licc.pdf>

HOW TO ORDER

LICA	3	T	102	M	3	F	C	4	A	A
Style & Size	Voltage	Dielectric	Cap/Section (EIA Code)	Capacitance Tolerance	Height Code	Termination	Reel Packaging	# of Caps/Part	Inspection Code	Code Face
9 = 5V Z = 10V 3 = 25V	D = X5R T = T55T S = High K T55T	102 = 1000 pF 103 = 10 nF 104 = 100 nF	M = ±20% P = GMV	6 = 0.500mm 3 = 0.650mm 1 = 0.875mm 5 = 1.100mm 7 = 1.600mm	F = C4 Solder Balls- 97Pb/3Sn H = C4 Solder Balls Low ESR G = Lead Free SAC R = Cr-Cu-Au N = Cr-Ni-Au V = Eutectic Lead-Tin Bump- 37%Pb/63%Sn X = None	M = 7" Reel R = 13" Reel 6 = 2"x2" Waffle Pack 8 = 2"x2" Black Waffle Pack 7 = 2"x2" Waffle Pack w/ termination facing up A = 2"x2" Black Waffle Pack w/ termination facing up C = 4"x4" Waffle Pack w/ clear lid	1 = one 2 = two 4 = four	A = Standard B = COTS-Plus X = MIL-PRF-123	A = Bar B = No Bar C = Dot, S55S Dielectrics D = Triangle	

NOTE: Contact factory for availability of Termination and Tolerance Options for Specific Part Numbers.

TERMINATION OPTIONS

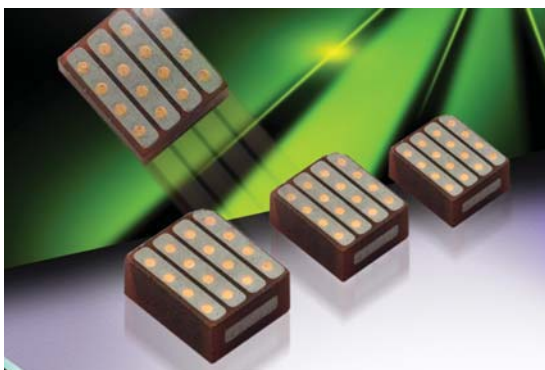
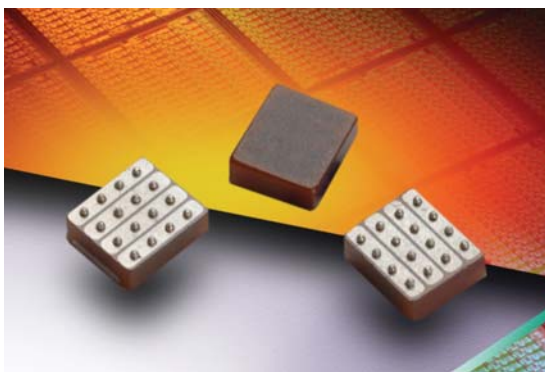

LICA COMMON PART NUMBER LIST

Part Number	Voltage	Thickness (mm)	Capacitors per Package
LICA3T193M3FC4AA	25	0.650	4
LICA3T153P3FC4AA	25	0.650	4
LICA3T134M1FC1AA	25	0.875	1
LICA3T104P1FC1AA	25	0.875	1
LICA3T333M1FC4AA	25	0.875	4
LICA3T263P3FC4AA	25	0.650	4
LICA3T244M5FC1AA	25	1.100	1
LICA3T194P5FC1AA	25	1.100	1
LICA3T394M7FC1AB	25	1.600	1
LICA3T314P7FC1AB	25	1.600	1
Extended Range			
LICAZT623M3FC4AB	10	0.650	4
LICA3T104M3FC1A	25	0.650	1
LICA3T803P3FC1A	25	0.650	1
LICA3T423M3FC2A	25	0.650	2
LICA3T333P3FC2A	25	0.650	2
LICA3S253M3FC4A	25	0.650	4
LICAZD753M3FC4AD	10	0.650	4
LICAZD504M3FC1AB	10	0.650	1
LICAZD604M7FC1AB	10	1.600	1
LICA3D193M3FC4AB	25	0.650	4

TAJ Series

Standard Tantalum Capacitors



- General purpose SMT chip tantalum series
- 6 case sizes available
- Low profile options available
- CV range: 0.10-2200 μ F / 2.5-50V



Check for up-to-date CV Tables at <http://www.avx.com/docs/catalogs/taj.pdf>

HOW TO ORDER

TAJ	C	106	M	035	R	NJ	-
Type	Case Size	Capacitance Code pF code: 1st two digits represent significant figures 3rd digit represents multiplier (number of zeros to follow)	Tolerance K=±10% M=±20%	Rated DC Voltage 002=2.5Vdc 004=4Vdc 006=6.3Vdc 010=10Vdc 016=16Vdc 020=20Vdc 025=25Vdc 035=35Vdc 050=50Vdc 063=63Vdc	Packaging R = 7" T/R (Lead Free since production date 1/1/04) S = 13" T/R (Lead Free since production date 1/1/04) A = Gold Plating 7" Reel B = Gold Plating 13" Reel H = Tin/Lead 7" reel (Contact Manufacturer) K = Tin/Lead 13" reel (Contact Manufacturer) H, K = Non RoHS	Specification Suffix NJ = Standard Suffix	Additional characters may be added for special requirements V = Dry pack Option (selected codes only)

Capacitance		Rated voltage DC (V _R) to 85°C									
μ F	Code	2.5V (e)	4V (G)	6.3V (J)	10V (A)	16V (C)	20V (D)	25V (E)	35V (V)	50V (T)	63V
0.10	104								A	A	
0.15	154								A	A/B	
0.22	224								A	A/B	
0.33	334								A	B	
0.47	474							A	A/B	A/B/C	
0.68	684						A	A	A/B	A/B/C	
1.0	105				A	A	A	A	A/B	A ^(M) /B/C	
1.5	155				A	A	A	A	A/B	C/D	
2.2	225			A	A	A/B	A/B	A/B	A/B/C	C/D	
3.3	335			A	A	A/B	A/B	A/B/C	B/C	C/D	
4.7	475		A	A	A/B	A/B	A/B/C	A/B/C	B/C/D	C/D	
6.8	685		A	A/B	A/B	A/B/C	A/B/C	B/C	C/D	C/D	
10	106		A	A/B	A/B/C	A/B/C	A ^(M) */B/C	B/C/D	C/D/E	D/E/V	
15	156		A/B	A/B	A/B/C	A ^(M) /B/C	B/C/D	C/D	C/D	D/E/V	E ^(M) *
22	226		A	A/B/C	A/B/C	A/B/C	B/C/D	C/D	D/E	V	V ^(M) *
33	336	A	A/B	A/B/C	A/B/C/D	B/C/D	C/D	D/E	D/E/V		
47	476	A	A/B	A/B/C/D	B/C/D	C/D	C/D/E	D/E	E/V		
68	686	A	A/B/C	B/C/D	B/C/D	C/D	C ^(M) /D/E	E/V	V ^(M)		
100	107	A/B	A/B/C	B/C/D	B ^(M) /C/D/E	C/D/E	D/E/V	E ^(M) /V			
150	157	B	B/C	B ^(M) /C/D	C/D/E	C/D/E	D/E/V	V ^(M)			
220	227	B/D	B ^(M) /C/D	C/D/E	C/D/E	E/V					
330	337	D	C/D/E	C/D/E	D/E/V	V					
470	477	C/D	C/D/E	D/E/V	E/V						
680	687	C/D/E	D/E	E/V							
1000	108	D ^(M) /E	D/E/V	E ^(M) /V ^(M)							
1500	158	D/E/V ^(M)	E/V ^(M)								
2200	228	V ^(M)									

Non preferred Ratings - not recommended for new designs, higher voltage or smaller case size substitution are offered.

Note: Voltage ratings are minimum values. AVX reserves the right to supply higher ratings in the same case size, to the same reliability standards.

Released codes ^(M tolerance only)

Engineering samples - please contact manufacturer

*Codes under development - subject to change

TAJ Low Profile

Low Profile Tantalum Capacitors

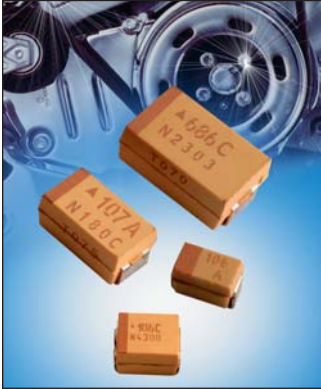

- General purpose SMT chip tantalum series
- CV range: 0.10-1000µF / 2.5-50V
- 9 case sizes in low profile option available



Check for up-to-date CV Tables at <http://www.avx.com/docs/catalogs/tajlp.pdf>

HOW TO ORDER

TAJ	C	107	M	010	R	NJ	-
Type	Case Size	Capacitance Code pF code: 1st two digits represent significant figures 3rd digit represents multiplier (number of zeros to follow)	Tolerance K=±10% M=±20%	Rated DC Voltage 002=2.5Vdc 004=4Vdc 006=6.3Vdc 010=10Vdc 016=16Vdc 020=20Vdc 025=25Vdc 035=35Vdc 050=50Vdc	Packaging R = 7" T/R (Lead Free since production date 1/1/04) S = 13" T/R (Lead Free since production date 1/1/04) A = Gold Plating 7" Reel B = Gold Plating 13" Reel	Specification Suffix NJ = Standard Suffix	Additional characters may be added for special requirements V = Dry pack Option (selected codes only)

Capacitance		Rated voltage DC (V _R) to 85°C								
µF	Code	2.5V (e)	4V (G)	6.3V (J)	10V (A)	16V (C)	20V (D)	25V (E)	35V (V)	50V (T)
0.10	104						R/S		R/S	S
0.15	154						R/S	R	R/S	S
0.22	224						R/S	R	R/S	S
0.33	334						R/S	R	R/S	S/T
0.47	474						R/S	R/S	R/S/T	S/T
0.68	684					R/S	R/S/T	R/S	P/S/T	
1.0	105				R/S	R/S/T	R/S/T	P/R/S	P/S/T	W
1.5	155			R/S	R/S	R/S	P/R/S/T	P/S/T	T	W
2.2	225		R/S	R/S	R/S	R/S/T	P/R/S/T	T	T	
3.3	335		R/S	R/S	R/S/T	R/S/T	T	T/W	W	Y
4.7	475	R	R/S	R/S/T	R/S/T	R/S/T	T	T/W	W	Y
6.8	685	R	R/S/T	R/S/T	P/R/S/T	S/T	T	W	Y	Y
10	106	R/S	R/S/T	P/R/S/T	K/P/R ^(M) /S/T	T/W	W	W	X/Y	
15	156	R	R/S/T	K/P/R/S/T	S/T/W	T ^(M) /W	W	Y	Y	
22	226	P/R	K/P/R/S/T	K/P ^(M) /S/T/W	T/W	W	W/Y	Y	Y	
33	336	K/P/S	K/P ^(M) /S/T/W	T/W	W	W/Y	X/Y	Y		
47	476	P ^(M) /S	T/W	T/W	W/Y	W/X/Y	X/Y	Y		
68	686	T	T/W	W	W/Y	F/X/Y	Y			
100	107	T/W	T ^(M) /W	W/Y	W/X/Y	F ^(M) /Y				
150	157	T ^(M) /W	W/Y	W/X/Y	F/X ^(M) /Y	Y ^(M)				
220	227	W/Y	W/X/Y	F/X/Y	Y					
330	337	W ^(M) /Y	F/X/Y	Y						
470	477	F/Y	Y	Y						
680	687	Y	Y ^(M)							
1000	108	Y ^(M)								

Released codes (M tolerance only)

Engineering samples - please contact manufacturer

*Codes under development - subject to change

Note: Voltage ratings are minimum values. AVX reserves the right to supply higher ratings in the same case size, to the same reliability standards.

TACmicrochip®

Small Case Size Tantalum Capacitors

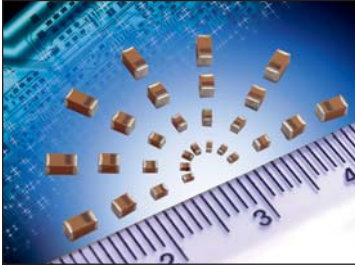

- The world's smallest surface mount tantalum capacitor
- CV range: 0.47 - 150µF / 2 - 25V
- 5 case sizes available
- Low profile options available
- Industrial and hi-rel medical applications



Check for up-to-date CV Tables at
<http://www.avx.com/docs/catalogs/tac.pdf>

HOW TO ORDER

TAC	L	226	M	004	R	TA
Type TACmicrochip®	Case Size	Capacitance Code pF code: 1st two digits represent significant figures, 3rd digit represents multiplier (number of zeros to follow)	Tolerance K=±10% M=±20%	Rated DC Voltage 002=2Vdc 003=3Vdc 004=4Vdc 006=6.3Vdc 010=10Vdc 016=16Vdc 020=20Vdc 025=25Vdc 050=50Vdc	Packaging R, P = 7" Standard Tin Termination Plastic Tape X, Q = 4 1/4" Standard Tin Termination Plastic Tape A = 7" Gold Termination Plastic Tape F = 4 1/4" Gold Termination Plastic Tape	Alternative characters may be used for special requirements

Capacitance		Voltage Rating DC (V _R) at 85°C								
µF	Code	2.0V	3.0V	4.0V	6.3V	10V	16V	20V	25V	50V
0.10	104							K*		
0.15	154									
0.22	224									
0.33	334									
0.47	474					K ^(M) /L	L			
0.68	684					K ^(M) /L	L			
1.0	105				K/L	K/L	L		R	A*
1.5	155			L	L	L	L			
2.2	225		K ^(M) /L	L	K ^(M) /L	L	L			
3.3	335	K ^(M) /L	K ^(M) /L	L	L	L/R	R*	R ^(M)		
4.7	475	K ^(M) /L	K ^(M) /L	L	L	L/R		R ^(M)	A*	
6.8	685	K ^(M) /L	L	L	L/R	L/R				
10	106	K ^(M) /L	L	L/R	L ^(M) /R	L/R	R			
15	156		R	L ^(M) /R	L ^(M) /R	R				
22	226	R	L ^(M) /R	L ^(M) /R	R	R				
33	336	R	R	R	R	A ^(M) /B ^(M) /R ^(M)				
47	476	R	R	R	A/R ^(M)	B				
68	686	R ^(M)	R ^(M)	A ^(M)	A ^(M) *					
100	107		A ^(M) /R ^(M)	A ^(M) /R ^(M)	A ^(M)					
150	157	A ^(M)								
220	227									

Released codes ^(M tolerance only)

*Codes under development - subject to change

Standard Height Profile: A, B, K, L, R Case

Low Profile: H, J, T, U, V Case

Note: Voltage ratings are minimum values. AVX reserves the right to supply higher ratings in the same case size, to the same reliability standards.

TACmicrochip® Low Profile

Low Profile Small Case Size Tantalum Capacitors

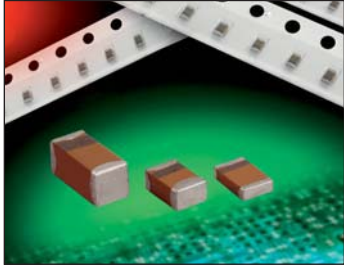

- The world's smallest surface mount tantalum capacitor
- CV range: 1.0-220µF / 2-16V
- 5 case sizes available in low profile option
- Industrial and hi-rel medical applications



Check for up-to-date CV Tables at
<http://www.avx.com/docs/catalogs/tac1p.pdf>

HOW TO ORDER

TAC Type TACmicrochip®	U Case Size	475 Capacitance Code pF code: 1st two digits represent significant figures, 3rd digit represents multiplier (number of zeros to follow)	M Tolerance K=±10% M=±20%	004 Rated DC Voltage 002=2Vdc 003=3Vdc 004=4Vdc 006=6.3Vdc 010=10Vdc 016=16Vdc	R Packaging R = 7" Standard Tin Termination Plastic Tape X = 4¼" Standard Tin Termination Plastic Tape A = 7" Gold Termination Plastic Tape F = 4¼" Gold Termination Plastic Tape	TA Alternative characters may be used for special requirements
--	----------------------------	---	--	---	--	---

Capacitance		Voltage Rating DC (V _R) at 85°C					
µF	Code	2.0V	3.0V	4.0V	6.3V	10V	16V
1.0	105						U ^(M)
1.5	155						
2.2	225					U ^(M)	
3.3	335				U ^(M)		
4.7	475			U ^(M)			
6.8	685						
10	106	U ^(M)		J ^(M)		H/V ^(M)	
15	156				H	V ^(M)	
22	226				H		
33	336			H			
47	476		H ^(M)			T	
68	686				T*		
100	107				T ^(M)		
150	157						
220	227		T ^(M)				

Released codes ^(M tolerance only)

*Codes under development - subject to change

Standard Height Profile: A, B, K, L, R Case

Low Profile: H, J, T, U, V Case

Note: Voltage ratings are minimum values. AVX reserves the right to supply higher ratings in the same case size, to the same reliability standards.

TLC Series

Consumer Series Small Case Size Tantalum Capacitors



- High capacitance vs. voltage ratio
- Super high volumetric efficiency
- CV range: 0.47-220µF / 2-35V
- 10 case sizes available
- Consumer applications (portable handheld electronics, cellular phones, digital equipments etc.)



Check for up-to-date CV Tables at <http://www.avx.com/docs/catalogs/tlc.pdf>

HOW TO ORDER

TLC Type	L Case Size	226 Capacitance Code pF code: 1st two digits represent significant figures, 3rd digit represents multiplier (number of zeros to follow)	M Tolerance M=±20%	006 Rated DC Voltage 002=2Vdc 003=3Vdc 004=4Vdc 006=6.3Vdc 010=10Vdc 016=16Vdc 020=20Vdc 025=25Vdc 035=35Vdc	R Packaging R, P = 7" Standard Tin Termination Plastic Tape X, Q = 4 1/4" Standard Tin Termination Plastic Tape A = 7" Gold Termination Plastic Tape F = 4 1/4" Gold Termination Plastic Tape	TA Standard Suffix OR 4000 ESR in mΩ
-------------------------	----------------------------	---	--------------------------------------	--	--	--

Capacitance		Voltage Rating DC (V _R) to 40°C								
µF	Code	2.0V	3.0V	4.0V	6.3V	10V	16V	20V	25V	35V
0.33	334						J*		L	
0.47	474					N*	K			
0.68	684									
1.0	105						J*	J*	L	L*/R
1.5	155									
2.2	225					J*/K	J*	H/L*	H/R	
3.3	335						L			
4.7	475			K/N*	K/U	J/K*				R*
6.8	685		K	K		U				
10	106		K	J/K/Z	J/K/Z	J*/U/Z*	V	R		A*
15	156	K	K*	K*/Z*		H/L				
22	226	J	J	J*	L/U*	L*/M			T*	
33	336			L	H/L/L(4000)	H				
47	476	L	L	H/L	H	C*/Q*/R				
68	686			R	R	A*/R*				
100	107		H*	C*/H*/Q*	R	R*/T				
150	157			R*	R*					
220	227	R*	S*	A*/R*/T						
330	337									
470	477	A*		A*						
680	687									

Released Codes

*Codes under development - subject to change

Note: Voltage ratings are minimum values. AVX reserves the right to supply higher ratings in the same case size, to the same reliability standards.

TLJ Series

High CV Consumer Series Tantalum Capacitors

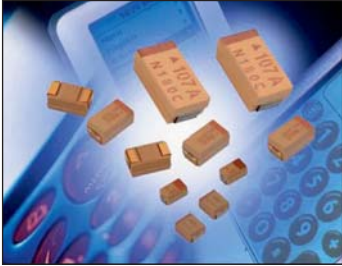

- High Volumetric Efficiency
- 3x reflow 260°C compatible
- 13 case sizes available including low profile codes
- Environmentally friendly
- Consumer applications (e.g. mobiles phones, PDA etc.)
- CV range: 10-680µF / 2.5-20V



Check for up-to-date CV Tables at
<http://www.avx.com/docs/catalogs/tlj.pdf>

HOW TO ORDER

TLJ	W	157	M	010	R	0200
Type	Case Size	Capacitance Code	Tolerance	Rated DC Voltage	Packaging	ESR in mΩ
		pF code: 1st two digits represent significant figures, 3rd digit represents multiplier (number of zeros to follow)	M = ±20%	002 = 2.5Vdc 004 = 4Vdc 006 = 6.3Vdc 010 = 10Vdc 016 = 16Vdc 020 = 20Vdc	R = 7" T/R S = 13" T/R	

Capacitance		Rated Voltage DC to 40°C / 0.5DC to 85°C / 0.2DC to 125°C						
µF	Code	2.5V (e)	4V (G)	6.3V (J)	10V (A)	16V (C)	20V (D)	35V (V)
6.8	685							
10	106				R(2000,3000)	P(4500)*S(2200)	T(1000)	
15	156				R(2000)			
22	226			N(5400)/R(3500)	K(1800)/N(3800) R(3800)	T(1000)		
33	336		N(8000)/R(3000)	K(1700)/N(8000) P(3000)/R(3000)	K(1500)/N(9600) P(3500) R(3500)/S(1500)	T(1000)		
47	476		K(1500)/N(4000) P(3000)/R(3000)	K(1500)/N(8300) P(700,900,1800,2500) R(3200)/S(1500)	A(600)/G(1500) P(3200)/R(3200) S(1500)/T(600)			
68	686		K(1200)/N(8000) P(3000) R(2900)/S(1500)	A(500)/G(800) S(1500)/T(600)	A(1500)			
100	107		A(500)/G(800) N(5200)/P(2700) S(1400)	A(500,800)/G(800) P(5400)/S(1400)* T(800)	A(1400) H(900)/T(900)			
150	157		A(800)/T(800)	A(900)/G(2500) H(900)/T(1200)	B(500) W(150,200)			
220	227	T(1100)	A(1100)/G(3000) H(900)/T(1100)	B(500)/T(2000) W(200)	B(1100)/F(300)			
330	337		T(2700)/W(200)	F(300)				
470	477							
680	687			Y(150)				
1000	108							
1500	158			V(200)*				

Available Ratings, (ESR ratings in mOhms in brackets)

Engineering samples - please contact manufacturer

*Codes under development - subject to change

Note: Voltage ratings are minimum values. AVX reserves the right to supply higher ratings in the same case size, to the same reliability standards.

TLN Series

Tantalum Solid Electrolytic Chip Capacitors Undertab Series



- Undertab terminations layout:
 - High Volumetric Efficiency
 - High PCB assembly density
 - High capacitance in smaller dimensions
- 3x reflow 260°C compatible
- Consumer applications (e.g. PCMCIA/USB wireless express cards, mobiles, MP3 etc.)
- 7 case sizes available
- CV range 47-1000µF / 4-10V



 Check for up-to-date CV Tables at <http://www.avx.com/docs/catalogs/tlnunder.pdf>

HOW TO ORDER

TLN	S	227	M	004	R	3000
Type	Case Size	Capacitance Code	Tolerance	Rated DC Voltage	Packaging	ESR in mΩ
		pF code: 1st two digits represent significant figures, 3rd digit represents multiplier (number of zeros to follow)	M = ±20%	004 = 4Vdc 006 = 6.3Vdc 010 = 10Vdc	R = 7" T/R S = 13" T/R	

Capacitance		Rated Voltage DC to 40°C / 0.5DC to 85°C/ 0.2DC to 125°C		
µF	Code	4V (G)	6.3V (J)	10V (A)
33	336			N(9600)*
47	476		N(8300)*	K(1500)/N(9600) R(4000)
68	686	N(3000)*	N(8300)*	K(7200)*S(6000)
100	107	N(5200)*	K(5400)/R(2000) S(5400)	K(9600)/L(7200)* S(7200)
150	157	K(4000)*R(4000)*	K(8300)/L(5400)* S(5400)	G(6000)/L(9600) S(7200)*T(6000)*
220	227	K(3000)/L(3000)* S(3000)	G(3000)/L(8300) S(8300)*T(3000)*	G(7200)*H(6000)* T(7200)
330	337	G(4000)*L(4000)* S(5200)*	G(5400)*H(3000)* T(5400)	H(7200)*T(9600)*
470	477	G(5200)*H(3000)* T(4000)*	H(5400)*T(8300)*	H(9600)*
680	687	H(4000)*T(5200)*	H(8300)*	
1000	108	H(5200)*	Y(150)	

Available Ratings, (ESR ratings in mOhms in brackets)

Engineering samples - please contact manufacturer

*Codes under development - subject to change

Note: Voltage ratings are minimum values. AVX reserves the right to supply higher ratings in the same case size, to the same reliability standards.

TPS Series

Low ESR Tantalum Capacitors



- Low ESR series of robust MnO₂ solid electrolyte capacitors
- CV range: 0.15-1500µF / 2.5-50V
- 14 case sizes available
- Power supply applications



Check for up-to-date CV Tables at <http://www.avx.com/docs/catalogs/tps.pdf>

HOW TO ORDER

TPS	C	107	M	010	R	0100	-
Type	Case Size	Capacitance Code pF code: 1st two digits represent significant figures, 3rd digit represents multiplier (number of zeros to follow)	Tolerance K = ±10% M = ±20%	Rated DC Voltage 002 = 2.5Vdc 004 = 4Vdc 006 = 6.3Vdc 010 = 10Vdc 016 = 16Vdc 020 = 20Vdc 025 = 25Vdc 035 = 35Vdc 050 = 50Vdc 063 = 63Vdc	Packaging R = 7" T/R (Lead Free since production date 1/1/04) S = 13" T/R (Lead Free since production date 1/1/04) A = Gold Plating 7" Reel B = Gold Plating 13" Reel H = Tin/Lead 7" reel (Contact Manufacturer) K = Tin/Lead 13" reel (Contact Manufacturer) H, K = Non RoHS	ESR in mΩ	Additional characters may be added for special requirements V = Dry pack Option (selected codes only)

Capacitance		Rated Voltage DC (V _r) to 85°C									
µF	Code	2.5V (e)	4V (G)	6.3V (J)	10V (A)	16V (C)	20V (D)	25V (E)	35V (V)	50V (T)	63V
0.15	154									A(9000)	
0.22	224								A(6000)	A(7000)	
0.33	334								A(6000)		
0.47	474							A(7000)	A(6000) B(4000)	C(2300)	
0.68	684							A(6000)	A(6000)		
1	105				R(9000)		A(3000), R(6000) S(6000), T(2000)	R(2500,4000)	A(3000) B(2000)	C(2500)	
1.5	155							A(3000) B(1800)	B(2500)	C(1500,2000)	
2.2	225		R(7000)		A(1800)	A(1800,3500) T(2000)	A(8000)	B(900,1200,2500)	A(1500), B(750, 1500,2000), C(1000)	D(1200)	
3.3	335				T(1500)	A(3500)		A(2500) B(1300)	A(1000,1500) B(750,1500,2000)	B(1000) C(700)	D(800)
4.7	475		S(4000)		A(1400) R(3000,5000)	A(2000) B(800,1500)	A(1800) B(750,1000)	B(700,900,1500)	B(700,1500) C(600), D(700)	D(300,500,700)	
6.8	685			A(1800)	A(1800) T(1800)	A(1500) B(600,1200)		B(600,1000) C(700)	C(350) D(150,400,500)	D(200,300, 500,600)	
10	106		R(3000)	A(1500) R(1000,1500,3000) T(1000)	A(900,1800) P(2000) ^M T(1000,2000)	B(500,800), C(500) T(800,1000) W(500,600)		B(500,1000) C(500,700) W(500)	B(1800) C(300,500)	D(125,300) E(200), Y(250)	E(400,500)
15	156			A(700,1500)	A(1000) B(450,600) T(1200)	B(500,800)		B(500) C(400,450)	C(220,300) D(100,300)	C(350,450) D(100,300) Y(250)	E(250) V(250)
22	226			A(500,900) B(375,600) S(900)	A(900) B(400,500,700) C(300), T(800)	B(400,600) C(150,250,300,375) W(500)		B(400,600) C(100,150,400) D(200,300)	C(275,400) D(100,200,300)	D(125,200,300,400) E(125,200,300) Y(200)	
33	336			A(600) B(250,350,450,600) T(800)	A(700) B(250,425,500,650) C(150,375,500) W(350)	B(350,500) C(100,150,225,300) D(200), W(140,175, 250,400,500) Y(300,400)		C(300) D(100,200)	D(100,200,300) E(100,175, 200,300) Y(200)	D(200,300) E(100,250,300) V(200)	
47	476		A(500)	A(900) B(250,350,500) C(300), T(1200)	B(250,350,500,650) C(200,350) D(100) W(125,150,250)	C(110,350) D(80,100,150,200) W(200) X(180), Y(250)	D(75,100,200) E(80,100,150) F(70,125,150)		D(125,150,250) 200,250)	E(200,250) V(150,200)	
68	686			B(250,350,500) C(150,200) W(110,125,250)	B(600) C(80,100,200,300) D(100,150), W(100,150) Y(100,200)	C(125,200) D(70,100,150) F(200), X(150) Y(150,200,250)		D(70,150, 200,300) E(125,150,200)	E(125,200) V(80,95,150,200)	V(150,200) ^M	
100	107	B(200)	B(200,250, 350,500) W(100)	B(250,400) C(75,150) W(100,150) Y(100)	B(400) ^M C(75,100,150,200) D(50,65,80,100,125, 150), E(125) W(150) X(65,150,200) Y(100,150,200)	C(200) D(60,100,125,150) E(55,100,125,150) F(150,200) ^M Y(100,150,200)		D(85,100,150) E(100,150,200) V(60,85,100,200)	V(100)		
150	157	B(150)	B(250) C(70,80)	C(50,90,150,200,250) D(50,125), Y(40,50)	D(50,85,100), E(100) F(200), X(100) ^M Y(100,150,200)	D(60,85,100,125,150) E(100), V(45,75) Y(200) ^M		V(80)			
220	227	B(150, 200,600) D(45)	D(40,50,100) Y(40,50,75)	C(70,100,125,250) D(50,100,125) E(100), F(200) Y(100,150)	D(40,50,100,150) E(50,60,70,100, 125,150) Y(100,150,200)	E(100,150) V(50,75,100,150)					
330	337	Y(40)	C(100) D(35,45,100) F(200) X(100)	C(80,100) D(45,50,70,100) E(50,100,125,150) V(100), Y(100,150)	D(50,65,100,150) E(40,50,60,100) V(40,60,100)						
470	477	D(35) F(200) Y(100)	D(45,100) E(35,45,100)	D(45,60,100,200) E(45,50,60,100,200) V(40,55,100), Y(150)	E(45,50,60,100,200) V(40,60,100)						
680	687	D(35,50) E(35,50) Y(100)	D(45,60,100) E(40,60,100)	E(45,60,100) V(35,40,50)							
1000	108	E(30,40) Y(100) ^M	E(40,60) V(25,35,40,50)	E(100) ^M , V(40,50) ^M							
1500	158	D(100) E(50) V(30,40) ^M	E(50,75) V(50,75) ^M								

Released codes ^M(tolerance only)

Engineering samples - please contact manufacturer

*Codes under development - subject to change

ESR limits quoted in brackets (milliohms)

NOTE: Voltage ratings are minimum values. AVX reserves the right to supply higher ratings in the same case size, to the same reliability standards.

TPM Multianode

Ultra Low ESR Tantalum Capacitors

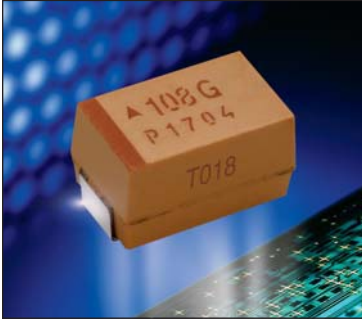

- Multi-anode construction
- Super low ESR
- CV range: 10-2200 μ F / 2.5-50V
- 4 case sizes available
- "Mirror" multi-anode construction used with D case capacitors reduces ESL to half



Check for up-to-date CV Tables at <http://www.avx.com/docs/catalogs/tpm.pdf>

HOW TO ORDER

TPM	E	108	M	004	R	0018
Type	Case Size	Capacitance Code pF code: 1st two digits represent significant figures, 3rd digit represents multiplier (number of zeros to follow)	Tolerance K= \pm 10% M= \pm 20%	Rated DC Voltage 002=2.5Vdc 004=4Vdc 006=6.3Vdc 010=10Vdc 016=16Vdc 020=20Vdc 025=25Vdc 035=35Vdc 050=50Vdc	Packaging R = 7" T/R Lead Free S = 13" T/R Lead Free H = Tin/Lead 7" reel (Contact Manufacturer) K = Tin/Lead 13" reel (Contact Manufacturer) H, K = Non RoHS	ESR in m Ω

Capacitance		Rated Voltage DC (V_R) to 85°C								
μ F	Code	2.5V (e)	4V (G)	6.3V (J)	10V (A)	16V (C)	20V (D)	25V (E)	35V (V)	50V (T)
6.8	685									
10	106									D(140) E(120)
15	156									E(75,100)
22	226								D(70) E(60,100)	E(75,100)
33	336							D(65)	E(50,65)	
47	476							D(55)	E(55,65)	
68	686							E(45,55)		
100	107				Y(45) ^(M)		E(35,45)			
150	157				Y(45) ^(M)	E(30,40)	E(35)			
220	227			Y(30) ^(M)	D(35)	E(25,40)				
330	337		D(25,35)	D(25,35)	D(35) E(23,35)	E(50)*				
470	477		D(25,35)	D(30) E(18,23,30)	E(23,30)					
680	687		D(25) E(18,23)	E(18,23), V(23)						
1000	108	D(25)	D(25,45) E(18,23), V(18)	E(25) ^(M) V(20) ^(M)						
1500	158	E(12,15,18)	E(15,18)							
2200	228	E(18) ^(M)								

Released codes ^(M tolerance only)

Engineering samples - please contact manufacturer

*Codes under development - subject to change

Note: Voltage ratings are minimum values. AVX reserves the right to supply higher ratings in the same case size, to the same reliability standards.

TPC Series

Low ESR Small Case Size Tantalum Capacitors

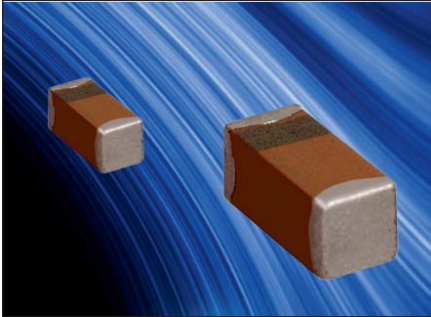

- Low ESR TACmicrochip® capacitor
- Smallest and low profile tantalum
- CV range: 1.0-100µF / 3-25V
- 4 case sizes available
- Power supply applications



Check for up-to-date CV Tables at <http://www.avx.com/docs/catalogs/tpc.pdf>

HOW TO ORDER

TPC	R	106	M	010	R	1800
Type TACmicrochip®	Case Size	Capacitance Code pF code: 1st two digits represent significant figures, 3rd digit represents multiplier (number of zeros to follow)	Tolerance K=±10% M=±20%	Rated DC Voltage 003=3Vdc 004=4Vdc 006=6.3Vdc 010=10Vdc 016=16Vdc 020=20Vdc 025=25Vdc	Packaging R, P = 7" Standard Tin Termination Plastic Tape X, Q = 4 1/4" Standard Tin Termination Plastic Tape A, M = 7" Gold Termination Plastic Tape F, N = 4 1/4" Gold Termination Plastic Tape	ESR in mΩ

Capacitance		Voltage Rating DC (V _R) at 85°C						
µF	Code	3.0V	4.0V	6.3V	10V	16V	20V	25V
1.0	105				L(5000)			R(3000)
1.5	155							
2.2	225			K(8000)/L(5000)	L(5000)	L(5000)		
3.3	335				L(5000)			
4.7	475	K(8000)			L(5000) ^(M)		R(1500) ^{(M)*}	
6.8	685							
10	106			L(4000) ^(M)	H(2500) L(4000) ^(M) , R(1800)	R(1800)		
15	156			R(1800)	R(1500)			
22	226		L(5000) ^(M) /R(1800)	R(1500)	R(1500)			
33	336	R(1800)	H(1500) ^(M) /R(1500)		R(1500) ^(M)			
47	476	R(1500)		R(1800) ^(M)				
68	686							
100	107		R(1000) ^(M)					

Codes shown are examples of ESR values offered on certain CV and case size. Other codes and ESR values available upon request.

Released codes ^(M tolerance only)

*Code under development – subject to change

Note: Voltage ratings are minimum values. AVX reserves the right to supply higher ratings in the same case size, to the same reliability standards

TCJ Series

Polymer Tantalum Capacitors

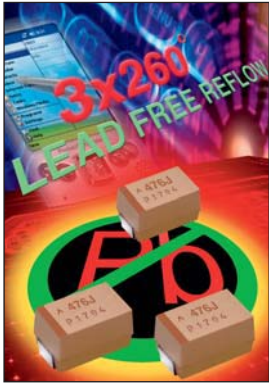

- Conductive polymer electrode reduces ignition failure mode
- Lower ESR
- 3x reflow 260°C compatible
- CV range: 1.0-220µF / 2.5-35V
- 11 case sizes available



Check for up-to-date CV Tables at <http://www.avx.com/docs/catalogs/tcj.pdf>

HOW TO ORDER

TCJ	A	226	M	004	R	0300
Type	Case Size	Capacitance Code pF code: 1st two digits represent significant figures, 3rd digit represents multiplier (number of zeros to follow)	Tolerance M=±20%	Rated DC Voltage 002=2.5Vdc 004=4Vdc 006=6.3Vdc 010=10Vdc 016=16Vdc 020=20Vdc 025=25Vdc 035=35Vdc	Packaging R=7" T/R S=13" T/R	ESR in mΩ

Capacitance		Rated Voltage DC (V _r) to 85°C						
µF	Code	2.5V (e)	4V (G)	6.3V (J)	10V (A)	16V (C)	25V (E)	35V (V)
1.0	105						P(500)	
4.7	475				K(500), R(500)			
6.8	685					A(200)		
10	106			A(300), R(500)	A(300)	A(200), B(200) T(150,200)		C(200)
15	156		A(300)	A(300)	A(200)	B(150)		
22	226		A(300)	A(300), K(400) S(400), T(150)	B(300), T(150)	B(150)	Y(70)*	
33	336		A(300)	A(200) B(70,200) T(150)	B(70,200) C(100) T(70,150)			
47	476		A(200), T(80)	A(200), B(70) K(400), P(500) T(80,120)	B(70), C(100)			
68	686	A(250)	A(250), B(70) T(80)	B(55), C(100) W(70)				
100	107	A(200), B(70)	A(200), B(70) G(300), T(150)	B(45,70)				
150	157	B(70)	B(70)	A(200), B(45,70) H(200), W(40,70) Y(25,40)*				
220	227		B(45,70)	B(200)				

Available Ratings, (ESR ratings in mOhms in brackets)

Engineering samples - please contact manufacturer

*Codes under development - subject to change

Note: Voltage ratings are minimum values. AVX reserves the right to supply higher ratings in the same case size, to the same reliability standards.

TCM Series

Tantalum Solid Electrolytic Chip Capacitors Conductive Polymer Multianode

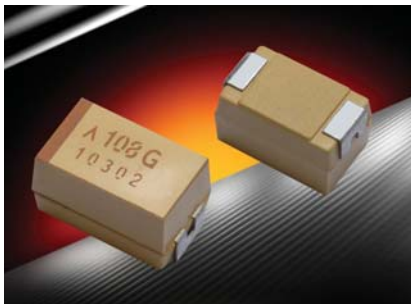

- Conductive polymer multianode
- Extremely Low ESR
- Reduced ignition failure mode
- 3x reflow 260°C compatible
- Volumetric efficiency
- High frequency capacitance retention



LEAD-FREE

LEAD-FREE COMPATIBLE COMPONENT



Check for up-to-date CV Tables at
<http://www.avx.com/docs/catalogs/tcm.pdf>

HOW TO ORDER

TCM

Type

E

Case Size
See table above

108

Capacitance Code
pF code: 1st two digits represent significant figures, 3rd digit represents multiplier (number of zeros to follow)

M

Tolerance
M=±20%

004

Rated DC Voltage
004=4Vdc
006=6.3Vdc
010=10Vdc
035=35Vdc

R

Packaging
R = 7" T/R
S = 13" T/R

0010

ESR in mΩ

CAPACITANCE AND RATED VOLTAGE, VR (VOLTAGE CODE) RANGE (LETTER DENOTES CASE SIZE)

Capacitance		Rated Voltage DC (V _R) to 85°C			
μF	Code	4V (G)	6.3V (J)	10V (A)	35V (V)
22	226				E(25)
33	336				
47	476				
68	686				
100	107				
150	157				
220	227				
330	337		E*	E*	
470	477		E*	E*	
680	687				
1000	108	E(10,12)			
1500	158				

Available Ratings, (ESR ratings in mOhms in brackets)

Engineering samples - please contact manufacturer

*Codes under development - subject to change

Note: Voltage ratings are minimum values. AVX reserves the right to supply higher ratings in the same case size, to the same reliability standards.

TCN Series

Tantalum Solid Electrolytic Chip Capacitors Undertab Series with Conductive Polymer Electrode

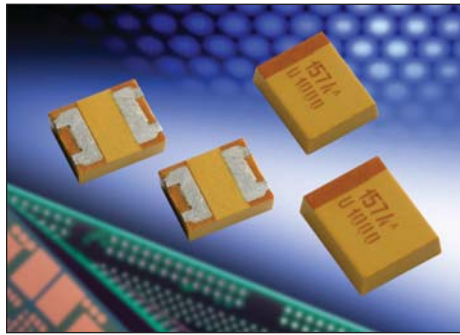

- Conductive polymer electrode reduces ignition failure mode
- Lower ESR
- Undertab terminations layout:
 - High Volumetric Efficiency
 - High PCB assembly density
 - High capacitance in smaller dimensions
- 3x reflow 260°C compatible
- Consumer applications (e.g. mobiles, MP3 etc.)
- 3 case sizes available



[Check for up-to-date CV Tables at http://www.avx.com/docs/catalogs/tcn.pdf](http://www.avx.com/docs/catalogs/tcn.pdf)

HOW TO ORDER

TCN	L	157	M	006	R	0200
Type	Case Size	Capacitance Code	Tolerance	Rated DC Voltage	Packaging	ESR in mΩ
		pF code: 1st two digits represent significant figures, 3rd digit represents multiplier (number of zeros to follow)	M = ±20%	004 = 4Vdc 006 = 6.3Vdc 010 = 10Vdc	R = 7" T/R S = 13" T/R	

Capacitance		Rated Voltage DC to 85°C / 0.66DC to 105°C		
μF	Code	4V (G)	6.3V (J)	10V (A)
15	156			N(500)*
22	226			N(500)*
33	336	N(500)*	K(500)*/N(500)*	K(500)*/N(500)*
47	476	N(500)*	K(500)*/T(120)	K(500)*/S(500)*
68	686	K(500)*/N(500)*	K(500)*/S(500)*	G(150)*/L(150)* S(500)*
100	107	K(500)*/S(500)*	G(200)*/L(200)*	G(150)*/L(150)* S(150)*/T(150)*
150	157	G(200)*/L(200)* S(500)*	G(200)/K(200)* L(200)/S(200)* T(200)	G(150)*/H(150)* T(150)*
220	227	G(200)*/L(150)* S(200)*/T(150)*	H(200)*/T(200)	H(150)*
330	337	H(150)*/T(150)*	H(200)*/T(200)*	
470	477	H(150)*		

Available Ratings, (ESR ratings in mOhms in brackets)

Engineering samples - please contact manufacturer

*Codes under development - subject to change

Note: Voltage ratings are minimum values. AVX reserves the right to supply higher ratings in the same case size, to the same reliability standards.

TRJ Series

Professional Series Tantalum Capacitors

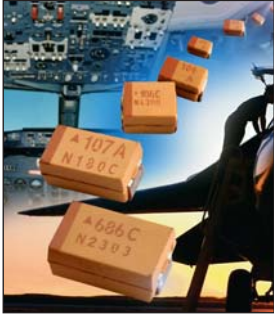

- Improved reliability – 2x standard
- DCL reduced by 25% to 0.0075 CV
- Robust against higher thermo-mechanical stresses during assembly process
- CV range: 0.10-470µF / 6.3-50V
- 5 case sizes available
- 117 low ESR parts released
- Automotive, medical, aerospace, military and other high-end applications



Check for up-to-date CV Tables at <http://www.avx.com/docs/catalogs/trj.pdf>

HOW TO ORDER

TRJ	B	105	*	035	R	RJ	-
Type	Case Size	Capacitance Code	Tolerance	Rated DC Voltage	Packaging/ Termination Plating	Standard Suffix	Additional characters may be added for special requirements
		pF code: 1st two digits represent significant figures, 3rd digit represents multiplier (number of zeros to follow)	K=±10% M=±20%	006 = 6.3V 010 = 10V 016 = 16V 020 = 20V 025 = 25V 035 = 35V 050 = 50V	R = 7" T/R S = 13" T/R A = Gold Plating 7" Reel B = Gold Plating 13" Reel H = Tin/Lead 7" reel (Contact Manufacturer) K = Tin/Lead 13" reel (Contact Manufacturer) H, K = Non RoHS	OR 0100 Low ESR in mΩ	V = Dry pack Option (selected codes only)

Capacitance		Rated Voltage DC (V _R) to 85°C						
µF	Code	6.3V (J)	10V (A)	16V (C)	20V (D)	25V (E)	35V (V)	50V (T)
0.10	104						A	
0.15	154						A, A(6000)	
0.22	224						A, A(6000)	A, A(7000)
0.33	334						A, A(6000)	A
0.47	474					A, A(7000)	A, A(4000)	B
0.68	684					A, A(6000)	A, A(6000)	B, B(2000)
1.0	105				A, A(3000)	A, A(3000)	A, B, A(3000), B(2000)	C, B, B(2000)
1.5	155				A, A(3000)	A, A(3000)	A, B, A(2000), B(2500)	C, C(1500)
2.2	225			A, A(3500)	A, A(3000)	A, B, A(1600), B(1200)	B, B(2000)	C, D, C(1000), D(1200)
3.3	335			A, A(3500)	A, B, A(2500), B(1300)	B, B(2000)	B, C, B(1000), C(800))	C, D, C(1000), D(800)
4.7	475		A, A(2000)	A, B, A(2000), B(1500)	A, B, A(1800), B(1000)	B, B(1000)	B, C, B(1500), C(600)	D, D(600)
6.8	685		A, A(1800)	A, B, A(1500), B(1200)	B, B(1000)	B, C, B(1000), C(600)	C, C(600)	D, D(700)
10	106	A, A(1500)	A, B, A(1800), B(800)	B, B(800)	B, C, B(1000), C(500)	C, C(600)	C, D, C(600), D(400)	E, E(400)
15	156	A, B, A(1500), B(700)	A, B, A(1000), B(600)	B, B(800)	B, C, B(500), C(400)	C, D, C(500), D(300)	D, D(350)	
22	226	A, B, A(900), B(600)	B, B(700)	B, C, B(600), C(350)	C, D, C(400), D(300)	D, D(300)	D, D(400)	
33	336	B, B(600)	B, C, B(650), C(300)	C, C(300)	C, D, C(300), D(250)	D, D(400)	E, E(250)	
47	476	B, C, B(500), C(250)	C, C(300)	C, D, C(350), D(200)	D, D(200)	D, E, D(250), E(150)		
68	686	C, C(200)	C, C(300)	D, D(150)	D, E, D(200), E(200)			
100	107	C, C(300)	C, D, C(200), D(150)	D, E, D(150), E(150)	E, E(150)			
150	157	C, D, C(300), D(150)	D, E, D(150), E(150)	E, E(150)				
220	227	D, D(150)	D, E, E(150)					
330	337	E, E(150)	E, E(100)					
470	477	E, E(200)						

Available Ratings, (ESR ratings in mOhms in brackets)
 Engineering samples - please contact manufacturer
 *Codes under development - subject to change

Note: Voltage ratings are minimum values. AVX reserves the right to supply higher ratings in the same case size, to the same reliability standards.

TAW Series

Tantalum Solid Electrolytic Fused Capacitors

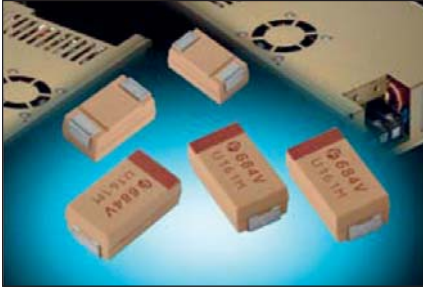

- Thin film fuse connected in series with capacitor
- Protection from possible damaging from high DC leakage current (short circuit failure)
- CV range: 6.8-100 μ F / 10-50V
- Application: servers



 Check for up-to-date CV Tables at
<http://www.avx.com/docs/catalogs/taw.pdf>

HOW TO ORDER

TAW	D	476	*	010	R	0500
Type	Case Size	Capacitance Code	Tolerance	Rated DC Voltage	Packaging	ESR in m Ω
		pF code: 1st two digits represent significant figures 3rd digit represents multiplier (number of zeros to follow)	K= \pm 10% M= \pm 20%	010=10Vdc 016=16Vdc 020=20Vdc 025=25Vdc 050=50Vdc	R = 7" T/R S = 13" T/R	

Capacitance		Rated Voltage DC (V_R) to 85°C					
μ F	Code	6.3V (J)	10V (A)	16V (C)	20V (D)	25V (E)	50V (T)
1.0	105						
2.2	225						
4.7	475						
6.8	685						D(700)
10	106					D(600)	D(700)
22	226					D(600)	
33	336			D(600)	D(500)		
47	476		D(500)	D(800)			
100	107		D(500)				

Available Ratings (ESR ratings in mOhms in brackets)

Engineering samples - please contact manufacturer

*Codes under development - subject to change

Note: Voltage ratings are minimum values. AVX reserves the right to supply higher ratings in the same case size, to the same reliability standards.

SMPS Stacked MLC Capacitors

SMX Style for High Temperatures Applications up to 200°C



SMX-style, stacked Switch Mode Power Supply Capacitors (SMPS) utilizing Multilayer Ceramic (MLCC) construction are ideally suited for high temperature applications up to 200°C. This product is intended for downhole oil exploration, including logging while drilling, geophysical probes, as well as space and aerospace electronics. The high temperature solder utilized in the construction of SMX-style parts assures reliable operation in harsh environments. The wide product offering provides designers a solution for high capacitance value and high voltage capacitors rated at 200°C. The SMX-style capacitors are ideally suited for applications as DC filters in high power, high frequency motor drives, high pulsed-current circuitry, as well as low power electronics.

SMX-style, SMPS capacitors are characterized with excellent performance in comparison to wet tantalum products. The main benefits of SMX-product over wet tantalum capacitors include:

- Much lower ESR and lower losses
- Excellent capacitance retention with frequency
- Excellent high frequency performance
- Low DC leakage current
- Much higher current handling capabilities

Check for up-to-date CV Tables at <http://www.avx.com/docs/catalogs/smx.pdf>

HOW TO ORDER AVX Styles: SMX1, SMX2, SMX3, SMX4, SMX5, SMX6

SMX	1	7	C	106	M	A	N	650
AVX Style SMX = Uncoated	Size	Voltage 3 = 25V 5 = 50V 1 = 100V 2 = 200V 7 = 500V	Temperature Coefficient COG = A X7R/X9U = C	Capacitance Code (2 significant digits + number of zeros) 10 pF = 100 100 pF = 101 1,000 pF = 102 22,000 pF = 223 220,000 pF = 224 1 μF = 105 10 μF = 106 100 μF = 107	Capacitance Tolerance COG: J = ±5% K = ±10% M = ±20% X7R: K = ±10% M = ±20% Z = +80%, -20%	Test Level A = Standard	Termination N = Straight Lead J = Leads formed in L = Leads formed out P = P Style Leads Z = Z Style Leads	Height Max Dimension "A" 120 = 0.120" 240 = 0.240" 360 = 0.360" 480 = 0.480" 650 = 0.650"

Note: Capacitors with X7R/X9U dielectric is not intended for applications across AC supply mains or AC line filtering with polarity reversal. Contact plant for recommendations.

Max Capacitance (μF) Available Versus Style with Height (A) of 0.120" - 3.05mm

AVX STYLE	SMX1		AN120					SMX2		AN120					SMX3		AN120					SMX4		AN120					SMX5		AN120					SMX6		AN120				
	25V	50V	100V	200V	500V	25V	50V	100V	200V	500V	25V	50V	100V	200V	500V	25V	50V	100V	200V	500V	25V	50V	100V	200V	500V	25V	50V	100V	200V	500V	25V	50V	100V	200V	500V							
COG	1.0	.70	.40	.18	.068	1.2	1.0	.60	.26	.10	.50	.40	.20	.09	.033	.16	.13	.07	.02	.01	.05	.04	.02	.01	.0039	3.2	2.4	1.3	.50	.20												
X7R/X9U	22	12	7.0	2.6	1.0	33	18	11	4.0	1.5	11	6.0	3.6	1.3	.50	3.3	1.8	1.1	.40	.15	1.2	.68	.40	.16	.056	68	40	24	9.4	3.3												

Max Capacitance (μF) Available Versus Style with Height (A) of 0.240" - 6.10mm

AVX STYLE	SMX1		AN240					SMX2		AN240					SMX3		AN240					SMX4		AN240					SMX5		AN240					SMX6		AN240				
	25V	50V	100V	200V	500V	25V	50V	100V	200V	500V	25V	50V	100V	200V	500V	25V	50V	100V	200V	500V	25V	50V	100V	200V	500V	25V	50V	100V	200V	500V	25V	50V	100V	200V	500V							
COG	2.0	1.4	.80	.36	.13	2.4	2.0	1.2	.52	.20	1.0	.80	.40	.18	.068	.33	.26	.14	.05	.02	.10	.08	.05	.02	.0078	6.4	4.8	2.6	1.0	.40												
X7R/X9U	44	24	14	5.2	2.0	66	36	22	8.0	3.0	22	12	7.2	2.6	1.0	6.6	3.6	2.2	.80	.30	2.4	1.3	.80	.32	.110	130	80	48	18	6.6												

Max Capacitance (μF) Available Versus Style with Height (A) of 0.360" - 9.14mm

AVX STYLE	SMX1		AN360					SMX2		AN360					SMX3		AN360					SMX4		AN360					SMX5		AN360					SMX6		AN360				
	25V	50V	100V	200V	500V	25V	50V	100V	200V	500V	25V	50V	100V	200V	500V	25V	50V	100V	200V	500V	25V	50V	100V	200V	500V	25V	50V	100V	200V	500V	25V	50V	100V	200V	500V							
COG	3.0	2.1	1.2	.54	.22	3.6	3.0	1.8	.78	.30	1.5	1.2	.60	.27	.10	.48	.39	.21	.07	.03	.15	.12	.07	.03	.011	10	7.2	3.9	1.5	.60												
X7R/X9U	68	36	21	7.8	3.0	100	54	33	12	4.5	33	18	10	3.9	1.5	10	5.4	3.3	1.2	.47	3.6	2.0	1.2	.48	.160	200	120	72	28	10												

Max Capacitance (μF) Available Versus Style with Height (A) of 0.480" - 12.2mm

AVX STYLE	SMX1		AN480					SMX2		AN480					SMX3		AN480					SMX4		AN480					SMX5		AN480					SMX6		AN480				
	25V	50V	100V	200V	500V	25V	50V	100V	200V	500V	25V	50V	100V	200V	500V	25V	50V	100V	200V	500V	25V	50V	100V	200V	500V	25V	50V	100V	200V	500V	25V	50V	100V	200V	500V							
COG	4.0	2.8	1.6	.72	.27	4.8	4.0	2.2	1.0	.40	2.0	1.6	.80	.36	.130	.64	.52	.28	.10	.04	.20	.16	.10	.04	.015	13	9.6	5.2	2.0	.80												
X7R/X9U	88	48	28	10	4.0	130	72	44	16	6.0	44	24	14	5.2	2.0	13	7.2	4.4	1.6	.60	4.8	2.7	1.6	.64	.22	270	160	96	37	13												

Max Capacitance (μF) Available Versus Style with Height (A) of 0.650" - 16.5mm

AVX STYLE	SMX1		AN650					SMX2		AN650					SMX3		AN650					SMX4		AN650					SMX5		AN650					SMX6		AN650				
	25V	50V	100V	200V	500V	25V	50V	100V	200V	500V	25V	50V	100V	200V	500V	25V	50V	100V	200V	500V	25V	50V	100V	200V	500V	25V	50V	100V	200V	500V	25V	50V	100V	200V	500V							
COG	5.0	3.5	2.0	.90	.34	6.0	5.0	3.0	1.3	.50	2.5	2.0	1.0	.45	.160	.82	.65	.35	.12	.05	.25	.20	.12	.05	.019	16	12	6.5	2.5	1.0												
X7R/X9U	110	60	35	13	5.0	160	90	55	20	7.5	56	30	18	6.5	2.5	16	9.0	5.5	2.0	.80	6.0	3.4	2.0	.80	.28	340	200	120	47	16												

SMPS Molded Radial MLC Capacitors

SXP Style for High Temperature Applications up to 200°C

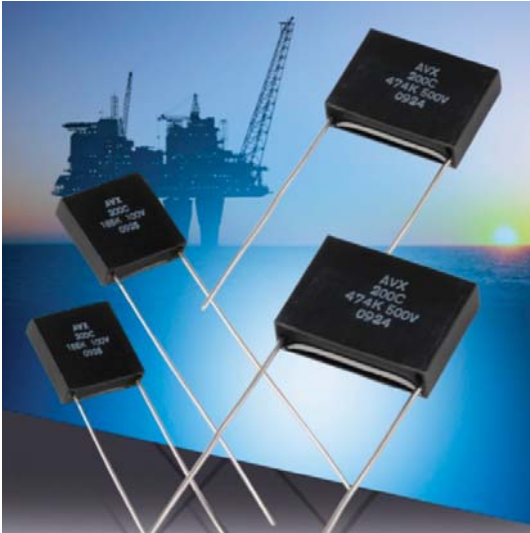

SXP-style, encapsulated radial leaded MLC capacitors are ideally suited for high temperature applications up to 200°C. This product is intended for downhole oil exploration, including logging while drilling, geophysical probes, as well as space, aerospace and hybrid automotive applications. This product supplements the SMX family of capacitors and offers mechanical protection to the ceramic element in extreme harsh environments. The high temperature solder utilized in the construction of SXP-style parts assures reliable operation in high temperature and rugged environments. The SXP-style capacitors are ideally suited for applications as DC filters in high power, high frequency motor drives, high pulsed-current circuitry, as well as standard electronic equipment designed for high temperature applications.

SXP-style, switch mode power supply capacitors are characterized with excellent performance. The main benefits of SXP product include:

- Low ESR, low ESL
- Low DC leakage
- Excellent high frequency performance

HOW TO ORDER

SMP	3	1	C	104	M	A	A
AVX Style	Size	Voltage	Temperature Coefficient	Capacitance Code	Capacitance Tolerance	Test Level	Leads
		5 = 50V 1 = 100V 2 = 200V 7 = 500V A = 1000V	COG = A X7R/X9U = C	(2 significant digits + number of zeros) 100 pF = 101 22,000 pF = 223 1µF = 105	COG: J = ±5% K = ±10% M = ±20% X7R: K = ±10% M = ±20% Z = +80%, -20%	A = Standard	A = Standard Tin/Lead (min. 5% Pb)
					Tighter tolerances available upon request		

CAPACITANCE RANGE

COG

Style	50V	100V	200V	500V	1000V
SXP1 (MIN)	1000pF	1000pF	1000pF	100pF	100pF
(MAX)	.047µF	.027µF	8200pF	4700pF	2200pF
SXP2 (MIN)	.01µF	1000pF	1000pF	100pF	100pF
(MAX)	.10µF	.056µF	.018µF	8200pF	4700pF
SXP3 (MIN)	.01µF	1000pF	1000pF	1000pF	1000pF
(MAX)	.15µF	.068µF	.022µF	.012µF	6800pF
SXP4 (MIN)	.01µF	.01µF	1000pF	1000pF	1000pF
(MAX)	.39µF	.22µF	.068µF	.033µF	.018µF

X7R

Style	50V	100V	200V	500V	1000V
SXP1 (MIN)	.1µF	.01µF	.01µF	.01µF	.01µF
(MAX)	1.2µF	.68µF	.27µF	.12µF	.033µF
SXP2 (MIN)	.1µF	.1µF	.01µF	.01µF	.01µF
(MAX)	2.2µF	1.2µF	.56µF	.22µF	.068µF
SXP3 (MIN)	.01µF	.1µF	.01µF	.01µF	.01µF
(MAX)	3.3µF	1.8µF	.82µF	.33µF	.10µF
SXP4 (MIN)	1µF	.1µF	.1µF	.01µF	.01µF
(MAX)	10µF	5.6µF	2.2µF	1.0µF	.27µF

THJ Series

High Temperature Tantalum Capacitors



- Improved reliability – 2x standard
- 175°C @ 0.5V_R continuous operation
- CV range: 0.10-220µF / 6.3-50V
- 5 case sizes available
- Low ESR options on approval
- High temperature automotive and industry applications



Check for up-to-date CV Tables at <http://www.avx.com/docs/catalogs/thj.pdf>

HOW TO ORDER

THJ	B	105	*	035	R	JN	—
Type	Case Size	Capacitance Code pF code: 1st two digits represent significant figures 3rd digit represents multiplier (number of zeros to follow)	Tolerance K=±10% M=±20%	Rated DC Voltage 006=6.3Vdc 010=10Vdc 016=16Vdc 020=20Vdc 025=25Vdc 035=35Vdc 050=50Vdc	Packaging R = 7" T/R S = 13" T/R A = Gold Plating 7" Reel B = Gold Plating 13" Reel H = Tin/Lead 7" reel (Contact Manufacturer) K = Tin/Lead 13" reel (Contact Manufacturer) H, K = Non RoHS	Standard Suffix OR 0100 Low ESR in mΩ	Additional characters may be added for special requirements V = Dry pack Option (selected codes only)

Capacitance		Rated voltage (V _R) to 85°C (Voltage Code)						
µF	Code	6.3V (J)	10V (A)	16V (C)	20V (D)	25V (E)	35V (V)	50V (T)
0.10	104						A	
0.15	154						A	
0.22	224						A	
0.33	334						A	
0.47	474					A	B	
0.68	684					A	B	
1.0	105						A/B	
1.5	155				A		C	
2.2	225			A		B	C	
3.3	335		A	A	B		C	D
4.7	475	A	A	A/B			C	D
6.8	685	A	A	A/B		C	D	
10	106	A	B	B		C	D	D/E
15	156	B	B	B	C		D	
22	226	B	B	C		D	D, D(3000)	
33	336	B	C	C	D	D	E	
47	476	C	C	C/D				
68	686	C	D	D				
100	107	D	D	E				
150	157	D						
220	227		E					

Available Ratings, (ESR ratings in mOhms in brackets)

Engineering samples - please contact manufacturer

*Codes under development - subject to change

Note: Voltage ratings are minimum values. AVX reserves the right to supply higher ratings in the same case size, to the same reliability standards.

THJ Series

High Temperature Tantalum Chip Capacitor with Extension to 200°C



- SMD 200°C tantalum capacitor
- 200°C @ 0.33VR 1000hrs continuous operation
- Leakage current after 200°C 1000hrs less than 1mA
- 3x reflow 260°C
- Gold plated termination for hybrid assembly
- Oil drilling, aerospace, automotive applications
- CV range: 100-220µF / 10-16V



[Check for up-to-date CV Tables at
http://www.avx.com/docs/catalogs/thj.pdf](http://www.avx.com/docs/catalogs/thj.pdf)

HOW TO ORDER

THJ	E	107	*	016	A	JH
Type	Case Size	Capacitance Code	Tolerance	Rated DC Voltage	Packaging	Standard Suffix
		pF code: 1st two digits represent significant figures 3rd digit represents multiplier (number of zeros to follow)	K=±10% M=±20%	010=10Vdc 016=16Vdc	A = Gold Plating 7" Reel B = Gold Plating 13" Reel	

Capacitance		Rated voltage (V _R) to 85°C (Voltage Code)						
µF	Code	6.3V (J)	10V (A)	16V (C)	20V (D)	25V (E)	35V (V)	50V (T)
33	336							
47	476							
68	686							
100	107			E				
150	157		E					
220	227							
330	337							
470	477							
680	687							

Available Ratings

Engineering samples - please contact manufacturer

*Codes under development – subject to change

Note: Voltage ratings are minimum values. AVX reserves the right to supply higher ratings in the same case size, to the same reliability standards

Standard X8R MLCC

X8R Dielectric

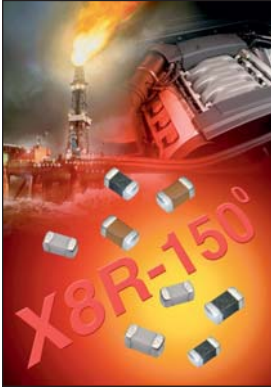

AVX has developed a range of multilayer ceramic capacitors designed for use in applications up to 150°C. These capacitors are manufactured with an X8R dielectric material which has a capacitance variation of ±15% between -55°C and +150°C.

The need for X8R performance has been driven by customer requirements for parts that operate at elevated temperatures. They provide a highly reliable capacitor with low loss and stable capacitance over temperature.

They are ideal for automotive under the hood sensors, measure while drilling and log while drilling. Typical applications include wire line logging tools such as gamma ray receivers, acoustic transceivers and micro-resistivity tools. They can also be used as bulk capacitors for high temperature camera modules.

X8R capacitors are available as standard and Automotive AEC-Q200 qualified parts. Optional termination systems, tin, FLEXITERM® and conductive epoxy for hybrid applications are available. Providing this series with our FLEXITERM® termination system provides further advantage to customers by way of enhanced resistance to both, temperature cycling and mechanical damage.

Check for up-to-date CV Tables at <http://www.avx.com/docs/catalogs/cx8r.pdf>

HOW TO ORDER

0805	5	F	104	K	4	T	2	A
Size 0603 0805 1206	Voltage 25V = 3 50V = 5	Dielectric X8R = F	Capacitance Code (In pF) 2 Sig. Digits + Number of Zeros e.g. 10µF = 106	Capacitance Tolerance J = ± 5% K = ± 10% M = ± 20%	Failure Rate 4 = Automotive A = Not Applicable	Terminations T = Plated Ni and Sn Z = FLEXITERM® U = Conductive Epoxy for Hybrid apps	Packaging 2 = 7" Reel 4 = 13" Reel	Special Code A = Std. Product

NOTE: Contact factory for availability of Termination and Tolerance Options for Specific Part Numbers.

SIZE	0603		0805		1206	
	25V	50V	25V	50V	25V	50V
271 Cap 270	G	G				
331 (pF) 330	G	G	J	J		
471 470	G	G	J	J		
681 680	G	G	J	J		
102 1000	G	G	J	J	J	J
152 1500	G	G	J	J	J	J
182 1800	G	G	J	J	J	J
222 2200	G	G	J	J	J	J
272 2700	G	G	J	J	J	J
332 3300	G	G	J	J	J	J
392 3900	G	G	J	J	J	J
472 4700	G	G	J	J	J	J
562 5600	G	G	J	J	J	J
682 6800	G	G	J	J	J	J
822 8200	G	G	J	J	J	J
103 Cap 0.01	G	G	J	J	J	J
123 (µF) 0.012	G	G	J	J	J	J
153 0.015	G	G	J	J	J	J
183 0.018	G	G	J	J	J	J
223 0.022	G	G	J	J	J	J
273 0.027	G	G	J	J	J	J
333 0.033	G	G	J	J	J	J
393 0.039	G	G	J	J	J	J
473 0.047	G	G	J	J	J	J
563 0.056	G		N	N	M	M
683 0.068	G		N	N	M	M
823 0.082			N	N	M	M
104 0.1			N	N	M	M
124 0.12			N	N	M	M
154 0.15			N	N	M	M
184 0.18			N		M	M
224 0.22			N		M	M
274 0.27					M	M
334 0.33					M	M
394 0.39					M	
474 0.47					M	
684 0.68						
824 0.82						
105 1						
	25V	50V	25V	50V	25V	50V
	0603		0805		1206	

■ = AEC-Q200 Qualified

Letter	A	C	E	G	J	K	M	N	P	Q	X	Y	Z
Max. Thickness	0.33 (0.013)	0.56 (0.022)	0.71 (0.028)	0.90 (0.035)	0.94 (0.037)	1.02 (0.040)	1.27 (0.050)	1.40 (0.055)	1.52 (0.060)	1.78 (0.070)	2.29 (0.090)	2.54 (0.100)	2.79 (0.110)
	PAPER					EMBOSSED							



Automotive MLCC

X8R Dielectric

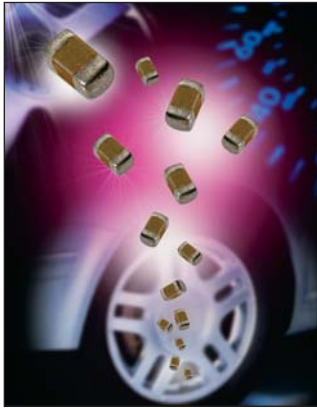

AVX Corporation has supported the Automotive Industry requirements for Multilayer Ceramic Capacitors consistently for more than 10 years. Products have been developed and tested specifically for automotive applications and all manufacturing facilities are QS9000 and VDA 6.4 approved.

As part of our sustained investment in capacity and state of the art technology, we are now transitioning from the established Pd/Ag electrode system to a Base Metal Electrode system (BME).

AVX is using AEC-Q200 as the qualification vehicle for this transition. A detailed qualification package is available on request and contains results on a range of part numbers including:

- X7R dielectric components containing BME electrode and copper terminations with a Ni/Sn plated overcoat.
- X7R dielectric components, BME electrode with epoxy finish for conductive glue mounting.
- X7R dielectric components BME electrode and soft terminations with a Ni/Sn plated overcoat.
- NP0 dielectric components containing Pd/Ag electrode and silver termination with a Ni/Sn plated overcoat.

Check for up-to-date CV Tables at <http://www.avx.com/docs/catalogs/cauto.pdf>

HOW TO ORDER

0805	5	F	104	K	4	T	2	A
Size	Voltage	Dielectric	Capacitance Code (In pF)	Capacitance Tolerance	Failure Rate	Terminations	Packaging	Special Code
0603 0805 1206	3 = 25V 5 = 50V	X8R = F	2 Significant Digits + Number of Zeros e.g. 10µF = 106	J = ±5% K = ±10% M = ±20%	4 = Automotive	T = Plated Ni and Sn Z = FLEXITERM® U = Conductive Epoxy	2 = 7" Reel 4 = 13" Reel	A = Std. Product

NOTE: Contact factory for non-specified capacitance values.
Contact factory for availability of Termination and Tolerance Options for Specific Part Numbers.

AUTOMOTIVE MLCC – X8R

SIZE	WVDC	0603		0805		1206	
		25V	50V	25V	50V	25V	50V
271	Cap 270	G	G				
331	(pF) 330	G	G	J	J		
471	470	G	G	J	J		
681	680	G	G	J	J		
102	1000	G	G	J	J	J	J
152	1500	G	G	J	J	J	J
182	1800	G	G	J	J	J	J
222	2200	G	G	J	J	J	J
272	2700	G	G	J	J	J	J
332	3300	G	G	J	J	J	J
392	3900	G	G	J	J	J	J
472	4700	G	G	J	J	J	J
562	5600	G	G	J	J	J	J
682	6800	G	G	J	J	J	J
822	8200	G	G	J	J	J	J
103	Cap 0.01	G	G	J	J	J	J
123	(µF) 0.012	G	G	J	J	J	J
153	0.015	G	G	J	J	J	J
183	0.018	G	G	J	J	J	J
223	0.022	G	G	J	J	J	J
273	0.027	G	G	J	J	J	J
333	0.033	G	G	J	J	J	J
393	0.039	G	G	J	J	J	J
473	0.047	G	G	J	J	J	J
563	0.056	G		N	N	M	M
683	0.068	G		N	N	M	M
823	0.082			N	N	M	M
104	0.1			N	N	M	M
124	0.12			N	N	M	M
154	0.15			N	N	M	M
184	0.18			N	N	M	M
224	0.22			N		M	M
274	0.27					M	M
334	0.33					M	M
394	0.39					M	
474	0.47					M	
684	0.68						
824	0.82						
105	1						
SIZE	WVDC	25V	50V	25V	50V	25V	50V

= AEC-Q200 Qualified

Letter	A	C	E	G	J	K	M	N	P	Q	X	Y	Z
Max. Thickness	0.33 (0.013)	0.56 (0.022)	0.71 (0.028)	0.90 (0.035)	0.94 (0.037)	1.02 (0.040)	1.27 (0.050)	1.40 (0.055)	1.52 (0.060)	1.78 (0.070)	2.29 (0.090)	2.54 (0.100)	2.79 (0.110)
	PAPER					EMBOSSED							

AEC-Q200 qualified
TS 16949, ISO 9001 certified



FLEXITERM® MLCC

X8R FLEXITERM® Automotive Series

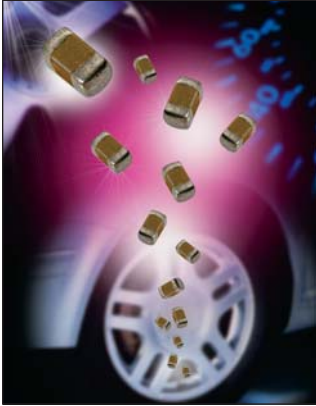

AVX has developed a range of multilayer ceramic capacitors designed for use in applications up to 150°C. These capacitors are manufactured with an X8R dielectric material which has a capacitance variation of ±15% between -55°C and +150°C.

The need for X8R performance has been driven by customer requirements for parts that operate at elevated temperatures. They provide a highly reliable capacitor with low loss and stable capacitance over temperature and are ideal for automotive under the hood sensors.

X8R capacitors are available as Automotive AEC-Q200 qualified parts. Optional termination systems, tin, FLEXITERM® and conductive epoxy for hybrid applications are available. Providing this series with our FLEXITERM® termination system provides further advantage to customers by way of enhanced resistance to both, temperature cycling and mechanical damage.

Check for up-to-date CV Tables at <http://www.avx.com/docs/catalogs/cx8r.pdf>

HOW TO ORDER

0805	5	F	104	K	4	Z	2	A
Size 0603 0805 1206	Voltage 3 = 25V 5 = 50V	Dielectric X8R = F	Capacitance Code (In pF) 2 Significant Digits + Number of Zeros e.g. 10µF = 106	Capacitance Tolerance J = ±5%* K = ±10% M = ±20%	Failure Rate 4 = Automotive	Terminations Z = FLEXITERM® U = Conductive Epoxy	Packaging 2 = 7" Reel 4 = 13" Reel	Special Code A = Std. Product

* ≤ 1µF only

NOTE: Contact factory for non-specified capacitance values.
Contact factory for availability of Termination and Tolerance Options for Specific Part Numbers.

AUTOMOTIVE MLCC – X8R

SIZE		0603		0805		1206	
Cap	WVDC	25V	50V	25V	50V	25V	50V
271	270	G	G				
331	330	G	G	J	J		
471	470	G	G	J	J		
681	680	G	G	J	J		
102	1000	G	G	J	J	J	J
152	1500	G	G	J	J	J	J
182	1800	G	G	J	J	J	J
222	2200	G	G	J	J	J	J
272	2700	G	G	J	J	J	J
332	3300	G	G	J	J	J	J
392	3900	G	G	J	J	J	J
472	4700	G	G	J	J	J	J
562	5600	G	G	J	J	J	J
682	6800	G	G	J	J	J	J
822	8200	G	G	J	J	J	J
103	0.01	G	G	J	J	J	J
123	0.012	G	G	J	J	J	J
153	0.015	G	G	J	J	J	J
183	0.018	G	G	J	J	J	J
223	0.022	G	G	J	J	J	J
273	0.027	G	G	J	J	J	J
333	0.033	G	G	J	J	J	J
393	0.039	G	G	J	J	J	J
473	0.047	G	G	J	J	J	J
563	0.056	G		N	N	M	M
683	0.068	G		N	N	M	M
823	0.082			N	N	M	M
104	0.1			N	N	M	M
124	0.12			N	N	M	M
154	0.15			N	N	M	M
184	0.18			N		M	M
224	0.22			N		M	M
274	0.27					M	M
334	0.33					M	M
394	0.39					M	
474	0.47					M	
684	0.68						
824	0.82						
105	1						
Cap	WVDC	25V	50V	25V	50V	25V	50V
SIZE	WVDC	0603		0805		1206	

Letter	A	C	E	G	J	K	M	N	P	Q	X	Y	Z
Max. Thickness	0.33 (0.013)	0.56 (0.022)	0.71 (0.028)	0.90 (0.035)	0.94 (0.037)	1.02 (0.040)	1.27 (0.050)	1.40 (0.055)	1.52 (0.060)	1.78 (0.070)	2.29 (0.090)	2.54 (0.100)	2.79 (0.110)
	PAPER					EMBOSSED							

AEC-Q200 qualified
TS 16949, ISO 9001 certified



Tin/Lead Termination MLCC

LD Series X8R Dielectric, Tin/Lead

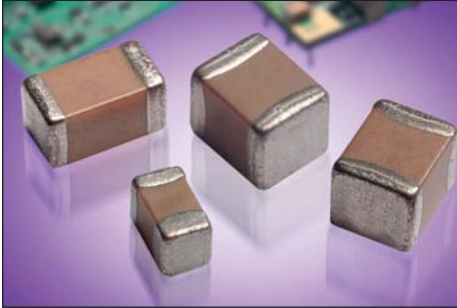

AVX Corporation will support those customers for commercial and military Multilayer Ceramic Capacitors with a termination consisting of 5% minimum lead. This termination is indicated by the use of a "B" in the 12th position of the AVX Catalog Part Number. This fulfills AVX's commitment to providing a full range of products to our customers. Please contact the factory if you require additional information on our MLCC Tin/Lead Termination "B" products.

Check for up-to-date CV Tables at <http://www.avx.com/docs/catalogs/tinterm.pdf>

HOW TO ORDER

- LD05**
 - 5**
 - F**
 - 101**
 - J**
 - A**
 - B**
 - 2**
 - A**
- Size**
LD03 - 0603
LD04 - 0504*
LD05 - 0805
LD06 - 1206
- Voltage**
3 = 25V
5 = 50V
- Dielectric**
X8R = F
- Capacitance Code (In pF)**
2 Sig. Digits
+ Number of Zeros
- Capacitance Tolerance**
J = ±5%
K = ±10%
M = ±20%
- Failure Rate**
A = Not Applicable
- Terminations**
B = 5% min lead
- Packaging**
2 = 7" Reel
4 = 13" Reel
7 = Bulk Cass.
9 = Bulk
- Special Code**
A = Std. Product

**Contact
Factory
For
Multiples**

*LD04 has the same CV ranges as LD03.

NOTE: Contact factory for availability of Tolerance Options for Specific Part Numbers.
Contact factory for non-specified capacitance values.

X8R Dielectric

SIZE		LD03		LD05		LD06	
	WVDC	25V	50V	25V	50V	25V	50V
271	Cap	G	G				
331	(pF)	G	G	J	J		
471		G	G	J	J		
681		G	G	J	J		
102		G	G	J	J	J	J
152		G	G	J	J	J	J
182		G	G	J	J	J	J
222		G	G	J	J	J	J
272		G	G	J	J	J	J
332		G	G	J	J	J	J
392		G	G	J	J	J	J
472		G	G	J	J	J	J
562		G	G	J	J	J	J
682		G	G	J	J	J	J
822		G	G	J	J	J	J
103	Cap	G	G	J	J	J	J
123	(µF)	G	G	J	J	J	J
153		G	G	J	J	J	J
183		G	G	J	J	J	J
223		G	G	J	J	J	J
273		G	G	J	J	J	J
333		G	G	J	J	J	J
393		G	G	J	J	J	J
473		G	G	J	J	J	J
563		G		N	N	M	M
683		G		N	N	M	M
823				N	N	M	M
104				N	N	M	M
124				N	N	M	M
154				N	N	M	M
184				N		M	M
224				N		M	M
274						M	M
334						M	M
394						M	
474						M	
684							
824							
105							
SIZE	WVDC	25V	50V	25V	50V	25V	50V
		LD03		LD05		LD06	

Letter	A	C	E	G	J	K	M	N	P	Q	X	Y	Z
Max. Thickness	0.33 (0.013)	0.56 (0.022)	0.71 (0.028)	0.90 (0.035)	0.94 (0.037)	1.02 (0.040)	1.27 (0.050)	1.40 (0.055)	1.52 (0.060)	1.78 (0.070)	2.29 (0.090)	2.54 (0.100)	2.79 (0.110)
	PAPER					EMBOSSED							

NOJ Series

Standard OxiCap® Niobium Oxide Capacitors

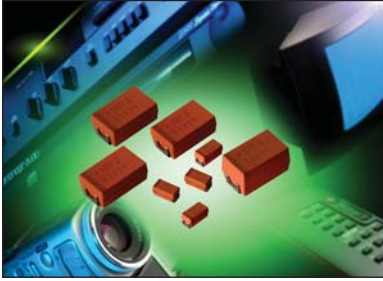

- Non-burn safe technology
- Reliability level: 0.5%/1000 hrs.
- 6 case sizes available
- Environmentally friendly
- IBM global approval received in 2004
- Electra Award received in 2005
- CV range: 4.7-1000µF / 1.8-10V



Electra Award
2005

Check for up-to-date CV Tables at
<http://www.avx.com/docs/catalogs/noj.pdf>

HOW TO ORDER

NOJ	D	107	M	006	R	WJ	-
Type	Case Size	Capacitance Code 1st two digits represent significant figures, 3rd digit represents multiplier in pF	Tolerance M=±20%	Rated DC Voltage 001 = 1.8Vdc 002 = 2.5Vdc 004 = 4Vdc 006 = 6.3Vdc 010 = 10Vdc	Packaging R = Lead Free 7" Reel S = Lead Free 13" Reel	Specification Suffix WJ = Standard Suffix	Additional characters may be added for special requirements V = Dry pack Option (selected codes only) with exception of D, E, V cases

Capacitance		Rated Voltage DC (V _R) to 85°C / 0.66 DC to 105°C				
µF	Code	1.8V (x)	2.5V (e)	4V (G)	6.3V (J)	10V (A)
4.7	475				A	A
6.8	685				A	A
10	106				A	A/B
15	156			A	A/B	A/B
22	226		A	A/B	A/B	B/C
33	336		A/B	A/B	B/C	C
47	476	A	A/B	A/B/C	B/C	C
68	686	B	B/C	B/C	B/C	C
100	107	B/C	B/C	B/C	B/C/D	D
150	157	C	C	C/D	C/D	E*
220	227	C	C	C/D	C/D/E	V*
330	337	C	C/D	D	D/E	
470	477		D/E	D/E	E/V	
680	687		E	E/V		
1000	108		V	V		



Released codes

Engineering samples - please contact manufacturer

*Codes under development - subject to change

Note: Voltage ratings are minimum values. AVX reserves the right to supply higher ratings in the same case size, to the same reliability standards.

NOJ Low Profile

Low Profile OxiCap® Niobium Oxide Capacitors

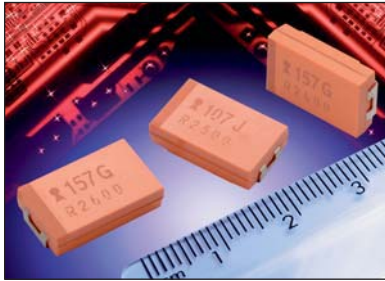

- Non-burn safe technology
- Reliability level: 0.5%/1000 hrs.
- CV range: 2.2-470µF / 1.8-10V
- 7 case sizes in low profile available
- IBM global approval received in 2004
- Electra Award received in 2005



Electra Award
2005

Check for up-to-date CV Tables at
<http://www.avx.com/docs/catalogs/nojlp.pdf>

HOW TO ORDER

NOJ	Y	107	M	006	R	WJ	-
Type	Case Size	Capacitance Code	Tolerance	Rated DC Voltage	Packaging	Specification Suffix	Additional characters may be added for special requirements
		1st two digits represent significant figures, 3rd digit represents multiplier in pF	M=±20%	001 = 1.8Vdc 002 = 2.5Vdc 004 = 4Vdc 006 = 6.3Vdc 010 = 10Vdc	R = Lead Free 7" Reel S = Lead Free 13" Reel	WJ = Standard Suffix	V = Dry pack Option (selected codes only) with exception of X, Y cases

Capacitance		Rated Voltage DC (V _R) to 85°C / 0.66 DC to 105°C				
µF	Code	1.8V (x)	2.5V (e)	4V (G)	6.3V (J)	10V (A)
1.0	105					
1.5	155					
2.2	225					P
3.3	335					P
4.7	475				P/S	T
6.8	685			P/S	P/S/T	T
10	106		P/S	P/S/T	P/T	T
15	156	P/S	P/S/T	P/T		
22	226	P/S/T	P/T	T	T	
33	336	T	T	T	W	
47	476	T	T	W	W	
68	686		W	W	X/Y	
100	107	W	W	W/X	F/Y	
150	157		X	Y	F/Y	
220	227	X	Y	F/Y	Y	
330	337	Y	Y	Y		
470	477	Y				

Released codes

Engineering samples - please contact manufacturer

*Codes under development - subject to change

Note: Voltage ratings are minimum values. AVX reserves the right to supply higher ratings in the same case size, to the same reliability standards.



LEAD-FREE

LEAD-FREE COMPATIBLE COMPONENT



RoHS COMPLIANT



NON-BURN
NON-SMOKE

NLJ Series

Niobium Oxide Capacitors High CV Consumer Series



- High Volumetric efficiency
- Environmentally friendly
- 3x reflow 260°C compatible
- Consumer applications
- OxiCap® non-burn technology
- RoHS compliance
- Lead-free solution
- 10 case sizes available
- CV range: 22-1000µF / 4-10V



Electra Award
2005

Check for up-to-date CV Tables at
<http://www.avx.com/docs/catalogs/nlj.pdf>

HOW TO ORDER

NLJ	A	476	M	006	R	1600
Type	Case Size	Capacitance Code 1st two digits represent significant figures, 3rd digit represents multiplier in pF	Tolerance M=±20%	Rated DC Voltage 004 = 4Vdc 006 = 6.3Vdc 010 = 10Vdc	Packaging R = 7" T/R S = 13" T/R	ESR in mΩ

Capacitance		Rated Voltage DC to 40°C / 0.5DC to 85°C / 0.33DC to 105°C		
µF	Code	4V (G)	6.3V (J)	10V (A)
6.8	685			K(4000)*P(5000)*
10	106		K(4000)*	K(2200)*P(6000)*
15	156	K(4000)*P(4000)*	P(3500)*	L(2800)*S(2000)*
22	226	P(4000)	L(2500)*S(1800)	A(3000)*G(3000)* L(2200)*
33	336	A(3000)*S(1700)*	G(2200)/L(2500)*	A(1700)/T(1800)*
47	476	A(2600)*G(2600)* L(1600)*	A(1600)/T(1600)	B(1000)/H(1000)* W(400)
68	686	A(1500)*T(1500)*	H(900)*	B(1400)*
100	107	H(900)*	B(1700)/W(600)	C(1200)/Y(1200)
150	157	B(1500)/W(400)		
220	227			D(1000)
330	337		C(500)/Y(500)	
470	477	C(500)/Y(500)		
680	687		D(500)	
1000	108	D(500)		

Available Ratings, (ESR ratings in mOhms in brackets)

Engineering samples - please contact manufacturer

*Codes under development - subject to change

Note: Voltage ratings are minimum values. AVX reserves the right to supply higher ratings in the same case size, to the same reliability standards.



LEAD-FREE

LEAD-FREE COMPATIBLE
COMPONENT



RoHS
COMPLIANT



NON-BURN
NON-SMOKE

NOS Series

Low ESR OxiCap® Niobium Oxide Capacitors



- Low ESR NbO capacitors
- Non-burn safe technology
- Reliability level: 0.2%/1000 hrs.
- CV range: 10-1000µF / 1.8-6.3V
- 9 case sizes available
- IBM global approval received in 2004
- Electra Award received in 2005



Electra Award
2005



Check for up-to-date CV Tables at
<http://www.avx.com/docs/catalogs/nos.pdf>

HOW TO ORDER

NOS

Type

D

Case Size

107

Capacitance Code
1st two digits
represent significant
figures, 3rd digit
represents multiplier
in pF

M

Tolerance
M=±20%

006

Rated
DC Voltage
001 = 1.8Vdc
002 = 2.5Vdc
004 = 4Vdc
006 = 6.3Vdc

R

Packaging
R = Lead Free
7" Reel
S = Lead Free
13" Reel

0100

ESR in mΩ

-

Additional
characters may be
added for special
requirements
V = Dry pack Option
(selected codes only)
with exception of
D, E, X, Y, V cases

Capacitance		Rated Voltage DC (V _R) to 85°C / 0.66 DC to 105°C / 0.5 DC to 125°C			
µF	Code	1.8V (x)	2.5V (e)	4.0V (G)	6.3V (J)
4.7	475				
6.8	685				
10	106				A(800, 1000, 2000)
15	156			A(1500)	B(600)
22	226		A(900)	B(600)	B(600)
33	336			B(600)	B(600) C(500) W(250)
47	476		B(500)	B(500) C(300) W(150)	B(500) C(300)
68	686		C(200) W(150)	C(200)	C(75,200) X(100) Y(100)
100	107	B(350) W(150)	C(150)	C(70,150) X(100)	C(150) D(80,100) Y(100)
150	157		C(65,150) X(100)	C(90,150) Y(100)	D(50,70,100) Y(100)
220	227	C(125) X(100)	C(80,125) Y(100)	D(40,60,100) Y(100)	D(45,60,100) E(80,100)
330	337	Y(100)	D(35,50,100) Y(100)	D(35,55,100) E(100)/Y(150)	E(80,100)
470	477	Y(100)	D(35,55,100) E(100)	D(100) E(75,100)	V(75)
680	687		E(60)	V(75)	
1000	108		V(50)		

Available Ratings, (ESR ratings in mOhms in brackets)

Engineering samples - please contact manufacturer

*Codes under development - subject to change

Note: Voltage ratings are minimum values. AVX reserves the right to supply higher ratings in the same case size, to the same reliability standards.



LEAD-FREE

LEAD-FREE COMPATIBLE
COMPONENT



RoHS
COMPLIANT



NON-BURN
NON-SMOKE

NOM Series

Ultra Low ESR OxiCap® Niobium Oxide Capacitors

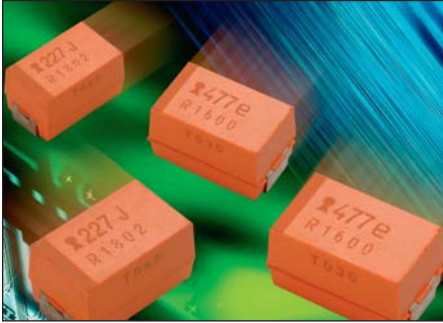

- Multi-anode construction
- Super low ESR
- Non-burn safe technology
- CV range: 220-680µF / 1.8-6.3V
- IBM global approval received in 2004
- Electra award received in 2005



Electra Award
2005

Check for up-to-date CV Tables at
<http://www.avx.com/docs/catalogs/nom.pdf>

HOW TO ORDER

NOM	E	227	M	006	R	0040
Type	Case Size	Capacitance Code	Tolerance	Rated DC Voltage	Packaging	ESR in mΩ
		1st two digits represent significant figures, 3rd digit represents multiplier in pF	M=±20%	001 = 1.8Vdc 002 = 2.5Vdc 004 = 4Vdc 006 = 6.3Vdc	R = Lead Free 7" Reel S = Lead Free 13" Reel	

Capacitance		Rated Voltage DC (V _R) to 85°C / 0.66 DC to 105°C / 0.5 DC to 125°C			
µF	Code	1.8V (x)	2.5V (e)	4.0V (G)	6.3V (J)
220	227				E(40)
330	337			E(35)	E(23,35)
470	477		E(30)	E(23,30)	
680	687	E(23)	E(23)		

Available Ratings, (ESR ratings in mOhms in brackets)

Engineering samples - please contact manufacturer

*Codes under development - subject to change

Note: Voltage ratings are minimum values. AVX reserves the right to supply higher ratings in the same case size, to the same reliability standards.



LEAD-FREE

LEAD-FREE COMPATIBLE COMPONENT



RoHS
COMPLIANT



NON-BURN
NON-SMOKE

Accu-F RF Capacitors

Thin Film Low ESR High Q Capacitors

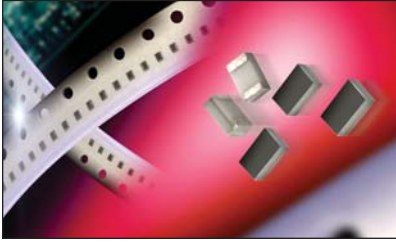

The use of very low-loss dielectric materials, silicon dioxide and silicon oxynitride, in conjunction with highly conductive electrode metals results in low ESR and high Q. These high-frequency characteristics change at a slower rate with increasing frequency than for ceramic microwave capacitors.

Because of the thin-film technology, the above-mentioned frequency characteristics are obtained without significant compromise of properties required for surface mounting.

Check for up-to-date CV Tables at <http://www.avx.com/docs/catalogs/accuf-p.pdf>

HOW TO ORDER

0402	3	J	4R7	A	A	W	TR
Size 0603 0805	Voltage 1 = 100V 5 = 50V 3 = 25V	Temperature Coefficient (1) J = 0±30ppm/°C (-55°C to +125°C) K = 0±60ppm/°C (-55°C to +125°C)	Capacitance Capacitance expressed in pF. (2 significant digits + number of zeros) for values <10pF, letter R denotes decimal point. Example: 68pF = 680 8.2pF = 8R2	Tolerance for C ≤ 2.0pF* P = ±0.02pF Q = ±0.03pF A = ±0.05pF B = ±0.1pF C = ±0.25pF for C ≤ 3.0pF Q = ±0.03pF A = ±0.05pF B = ±0.1pF C = ±0.25pF for C ≥ 10pF F = ±1% G = ±2% J = ±5%	Specification Code A = Accu-F® technology	Termination Code W = Nickel/Solder Coated Accu-F® Sn63, Pb37	Packaging Code TR = Tape & Reel

(1) TC's shown are per EIA/IEC Specifications.

* Tolerances as tight as ±0.01pF are available. Please consult the factory.

TEMP. COEFFICIENT CODE

“J” = 0±30ppm/°C (-55°C to +125°C)⁽²⁾

Size Code	0603			0805		
	100	50	25	100	50	25
Cap in pF ⁽¹⁾						
Cap code						
0.1 – 0R1						
0.2 – 0R2						
0.3 – 0R3						
0.4 – 0R4						
0.5 – 0R5						
0.6 – 0R6						
0.7 – 0R7						
0.8 – 0R8						
0.9 – 0R9						
1.0 – 1R0						
1.2 – 1R2						
1.5 – 1R5						
1.8 – 1R8						
2.2 – 2R2						
2.7 – 2R7						
3.3 – 3R3						
3.9 – 3R9						
4.7 – 4R7						
5.6 – 5R6						
6.8 – 6R8						
8.2 – 8R2						
10 – 100						
12 – 120						
15 – 150						
18 – 180						
22 – 220						
27 – 270						
33 – 330						
39 – 390						
47 – 470						
56 – 560						
68 – 680						
82 – 820						
100 – 101						
120 – 121						
150 – 151						

TEMP. COEFFICIENT CODE

“K” = 0±60ppm/°C (-55°C to +125°C)⁽²⁾

Size Code	0603			0805		
	100	50	25	100	50	25
Cap in pF ⁽¹⁾						
Cap code						
0.1 – 0R1						
0.2 – 0R2						
0.3 – 0R3						
0.4 – 0R4						
0.5 – 0R5						
0.6 – 0R6						
0.7 – 0R7						
0.8 – 0R8						
0.9 – 0R9						
1.0 – 1R0						
1.2 – 1R2						
1.5 – 1R5						
1.8 – 1R8						
2.2 – 2R2						
2.7 – 2R7						
3.3 – 3R3						
3.9 – 3R9						
4.7 – 4R7						
5.6 – 5R6						
6.8 – 6R8						
8.2 – 8R2						
10 – 100						
12 – 120						
15 – 150						
18 – 180						
22 – 220						
27 – 270						
33 – 330						
39 – 390						
47 – 470						
56 – 560						
68 – 680						
82 – 820						
100 – 101						
120 – 121						
150 – 151						

(1) For capacitance values higher than listed in table, please consult factory.
(2) TC shown is per EIA/IEC Specifications.



Intermediate values are available within the indicated range.

SQCA/CB RF Capacitors

Ceramic (0505/1111) Low ESR High Q Capacitors

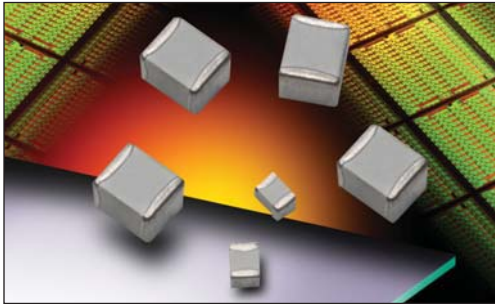

SQCA (0505) & SQCB (1111) are AVX's Ultra Low ESR microwave capacitors. Suitable for RF Power Amplifiers, they come in non-mag termination for MRI applications. They offer very High Q & resonant frequency and power handling capability.



Check for up-to-date CV Tables at <http://www.avx.com/docs/catalogs/sq.pdf>

HOW TO ORDER

SQ	CB	7	M	100	J	A	T	1A
AVX Style SQ	Case Size CA = 0505 CB = 1111	Voltage Code 5 = 50V E = 150V 2 = 200V V = 250V 9 = 300V 7 = 500V	Temperature Coefficient Code M = +90±20ppm/°C A = 0±30ppm/°C C = 15% (*J Termination only)	Capacitance EIA Capacitance Code in pF. First two digits = significant figures or "R" for decimal place. Third digit = number of zeros or after "R" significant figures.	Capacitance Tolerance Code B = ±.1 pF C = ±.25 pF D = ±.5 pF F = ±1% G = ±2% J = ±5% K = ±10% M = ±20% N = ±30%	Failure Rate Code A = Not Applicable	Termination Style Code *1 = Pd/Ag *7 = Ag/Ni/Au J = Nickel Barrier Tin/Lead (60/40) *T = 100% Tin *RoHS Compliant	Packaging Code 1A = 7" Reel Unmarked 6A = Waffle Pack Unmarked ME = 7" Reel Marked WE = Waffle Pack Unmarked *Vertical T&R available *500 piece reels available

Case Size A

TABLE I: TC: M (+90±20PPM/°C)

Cap. pF	Cap. Tol.	WVDC	Cap. pF	Cap. Tol.	WVDC	Cap. pF	Cap. Tol.	WVDC	Cap. pF	Cap. Tol.	WVDC
0.1	B	150, 250	1.7	B, C, D	150, 250	6.2	B, C, D	150, 250	27	F, G, J, K	150, 250
0.2	B	150, 250	1.8	B, C, D	150, 250	6.8	B, C, J, K	150, 250	30	F, G, J, K	150, 250
0.3	B,C	150, 250	1.9	B, C, D	150, 250	7.5	B, C, J, K	150, 250	33	F, G, J, K	150, 250
0.4	B,C	150, 250	2.0	B, C, D	150, 250	8.2	B, C, J, K	150, 250	36	F, G, J, K	150, 250
0.5	B, C, D	150, 250	2.2	B, C, D	150, 250	9.1	B, C, J, K	150, 250	39	F, G, J, K	150, 250
0.6	B, C, D	150, 250	2.4	B, C, D	150, 250	10	F, G, J, K	150, 250	43	F, G, J, K	150, 250
0.7	B, C, D	150, 250	2.7	B, C, D	150, 250	11	F, G, J, K	150, 250	47	F, G, J, K	150, 250
0.8	B, C, D	150, 250	3.0	B, C, D	150, 250	12	F, G, J, K	150, 250	51	F, G, J, K	150, 250
0.9	B, C, D	150, 250	3.3	B, C, D	150, 250	13	F, G, J, K	150, 250	56	F, G, J, K	150, 250
1.0	B, C, D	150, 250	3.6	B, C, D	150, 250	15	F, G, J, K	150, 250	62	F, G, J, K	150, 250
1.1	B, C, D	150, 250	3.9	B, C, D	150, 250	16	F, G, J, K	150, 250	68	F, G, J, K	150, 250
1.2	B, C, D	150, 250	4.3	B, C, D	150, 250	18	F, G, J, K	150, 250	75	F, G, J, K	150, 250
1.3	B, C, D	150, 250	4.7	B, C, D	150, 250	20	F, G, J, K	150, 250	82	F, G, J, K	150, 250
1.4	B, C, D	150, 250	5.1	B, C, D	150, 250	22	F, G, J, K	150, 250	91	F, G, J, K	150, 250
1.5	B, C, D	150, 250	5.6	B, C, D	150, 250	24	F, G, J, K	150, 250	100	F, G, J, K	150, 250
1.6	B, C, D	150, 250									

TABLE II: TC: A (0±30PPM/°C)

Cap. pF	Cap. Tol.	WVDC	Cap. pF	Cap. Tol.	WVDC	Cap. pF	Cap. Tol.	WVDC	Cap. pF	Cap. Tol.	WVDC
0.1	B	150	2.7	B, C, D	150	20	F, G, J, K	150	150	F, G, J, K	50
0.2	B	150	3.0	B, C, D	150	22	F, G, J, K	150	160	F, G, J, K	50
0.3	B,C	150	3.3	B, C, D	150	24	F, G, J, K	150	180	F, G, J, K	50
0.4	B,C	150	3.6	B, C, D	150	27	F, G, J, K	150	200	F, G, J, K	50
0.5	B, C, D	150	3.9	B, C, D	150	30	F, G, J, K	150	220	F, G, J, K	50
0.6	B, C, D	150	4.3	B, C, D	150	33	F, G, J, K	150	240	F, G, J, K	50
0.7	B, C, D	150	4.7	B, C, D	150	36	F, G, J, K	150	270	F, G, J, K	50
0.8	B, C, D	150	5.1	B, C, D	150	39	F, G, J, K	150	300	F, G, J, K	50
0.9	B, C, D	150	5.6	B, C, D	150	43	F, G, J, K	150	330	F, G, J, K	50
1.0	B, C, D	150	6.2	B, C, D	150	47	F, G, J, K	150	360	F, G, J, K	50
1.1	B, C, D	150	6.8	B, C, J, K	150	51	F, G, J, K	150	390	F, G, J, K	50
1.2	B, C, D	150	7.5	B, C, J, K	150	56	F, G, J, K	150	430	F, G, J, K	50
1.3	B, C, D	150	8.2	B, C, J, K	150	62	F, G, J, K	150	470	F, G, J, K	50
1.4	B, C, D	150	9.1	B, C, J, K	150	68	F, G, J, K	150	510	F, G, J, K	50
1.5	B, C, D	150	10	F, G, J, K	150	75	F, G, J, K	150	560	F, G, J, K	50
1.6	B, C, D	150	11	F, G, J, K	150	82	F, G, J, K	150	620	F, G, J, K	50
1.7	B, C, D	150	12	F, G, J, K	150	91	F, G, J, K	150	680	F, G, J, K	50
1.8	B, C, D	150	13	F, G, J, K	150	100	F, G, J, K	150	750	F, G, J, K	50
1.9	B, C, D	150	15	F, G, J, K	150	110	F, G, J, K	50	820	F, G, J, K	50
2.0	B, C, D	150	16	F, G, J, K	150	120	F, G, J, K	50	910	F, G, J, K	50
2.2	B, C, D	150	18	F, G, J, K	150	130	F, G, J, K	50	1000	F, G, J, K	50
2.4	B, C, D	150									

SQCA/CB RF Capacitors

Ceramic (0505/1111) Low ESR High Q Capacitors



Case Size A

TABLE III: TC: C ($\pm 15\%$)

Cap. pF	Cap. Tol.	WVDC	Cap. pF	Cap. Tol.	WVDC	Cap. pF	Cap. Tol.	WVDC
1000	K, M, N	50	2200	K, M, N	50	5100	K, M, N	50
1200	K, M, N	50	2700	K, M, N	50	5600	K, M, N	50
1500	K, M, N	50	3300	K, M, N	50	6800	K, M, N	50
1800	K, M, N	50	3900	K, M, N	50	8200	K, M, N	50
2000	K, M, N	50	4700	K, M, N	50	10000	K, M, N	50

Case Size B

TABLE IV: TC: M ($+90\pm 20\text{PPM}/^\circ\text{C}$)

Cap. pF	Cap. Tol.	WVDC	Cap. pF	Cap. Tol.	WVDC	Cap. pF	Cap. Tol.	WVDC	Cap. pF	Cap. Tol.	WVDC
0.1	B	500	2.7	B, C, D	500	20	F, G, J, K	500	150	F, G, J, K	300
0.2	B	500	3.0	B, C, D	500	22	F, G, J, K	500	160	F, G, J, K	300
0.3	B, C	500	3.3	B, C, D	500	24	F, G, J, K	500	180	F, G, J, K	300
0.4	B, C	500	3.6	B, C, D	500	27	F, G, J, K	500	200	F, G, J, K	300
0.5	B, C, D	500	3.9	B, C, D	500	30	F, G, J, K	500	220	F, G, J, K	200
0.6	B, C, D	500	4.3	B, C, D	500	33	F, G, J, K	500	240	F, G, J, K	200
0.7	B, C, D	500	4.7	B, C, D	500	36	F, G, J, K	500	270	F, G, J, K	200
0.8	B, C, D	500	5.1	B, C, D	500	39	F, G, J, K	500	300	F, G, J, K	200
0.9	B, C, D	500	5.6	B, C, D	500	43	F, G, J, K	500	330	F, G, J, K	200
1.0	B, C, D	500	6.2	B, C, D	500	47	F, G, J, K	500	360	F, G, J, K	200
1.1	B, C, D	500	6.8	B, C, J, K	500	51	F, G, J, K	500	390	F, G, J, K	200
1.2	B, C, D	500	7.5	B, C, J, K	500	56	F, G, J, K	500	430	F, G, J, K	200
1.3	B, C, D	500	8.2	B, C, J, K	500	62	F, G, J, K	500	470	F, G, J, K	200
1.4	B, C, D	500	9.1	B, C, J, K	500	68	F, G, J, K	500	510	F, G, J, K	150
1.5	B, C, D	500	10	F, G, J, K	500	75	F, G, J, K	500	560	F, G, J, K	150
1.6	B, C, D	500	11	F, G, J, K	500	82	F, G, J, K	500	620	F, G, J, K	150
1.7	B, C, D	500	12	F, G, J, K	500	91	F, G, J, K	500	680	F, G, J, K	150
1.8	B, C, D	500	13	F, G, J, K	500	100	F, G, J, K	500	750	F, G, J, K	150
1.9	B, C, D	500	15	F, G, J, K	500	110	F, G, J, K	300	820	F, G, J, K	150
2.0	B, C, D	500	16	F, G, J, K	500	120	F, G, J, K	300	910	F, G, J, K	150
2.2	B, C, D	500	18	F, G, J, K	500	130	F, G, J, K	300	1000	F, G, J, K	150
2.4	B, C, D	500									

TABLE V: TC: A ($0\pm 30\text{PPM}/^\circ\text{C}$)

Cap. pF	Cap. Tol.	WVDC	Cap. pF	Cap. Tol.	WVDC	Cap. pF	Cap. Tol.	WVDC	Cap. pF	Cap. Tol.	WVDC
0.1	B	500	3.9	B, C, D	500	47	F, G, J, K	500	560	F, G, J, K	150
0.2	B	500	4.3	B, C, D	500	51	F, G, J, K	500	620	F, G, J, K	150
0.3	B, C	500	4.7	B, C, D	500	56	F, G, J, K	500	680	F, G, J, K	150
0.4	B, C	500	5.1	B, C, D	500	62	F, G, J, K	500	750	F, G, J, K	150
0.5	B, C, D	500	5.6	B, C, D	500	68	F, G, J, K	500	820	F, G, J, K	150
0.6	B, C, D	500	6.2	B, C, D	500	75	F, G, J, K	500	910	F, G, J, K	150
0.7	B, C, D	500	6.8	B, C, J, K	500	82	F, G, J, K	500	1000	F, G, J, K	150
0.8	B, C, D	500	7.5	B, C, J, K	500	91	F, G, J, K	500	1100	F, G, J, K	50
0.9	B, C, D	500	8.2	B, C, J, K	500	100	F, G, J, K	500	1200	F, G, J, K	50
1.0	B, C, D	500	9.1	B, C, J, K	500	110	F, G, J, K	300	1300	F, G, J, K	50
1.1	B, C, D	500	10	F, G, J, K	500	120	F, G, J, K	300	1500	F, G, J, K	50
1.2	B, C, D	500	11	F, G, J, K	500	130	F, G, J, K	300	1600	F, G, J, K	50
1.3	B, C, D	500	12	F, G, J, K	500	150	F, G, J, K	300	1800	F, G, J, K	50
1.4	B, C, D	500	13	F, G, J, K	500	160	F, G, J, K	300	2000	F, G, J, K	50
1.5	B, C, D	500	15	F, G, J, K	500	180	F, G, J, K	300	2200	F, G, J, K	50
1.6	B, C, D	500	16	F, G, J, K	500	200	F, G, J, K	300	2400	F, G, J, K	50
1.7	B, C, D	500	18	F, G, J, K	500	220	F, G, J, K	200	2700	F, G, J, K	50
1.8	B, C, D	500	20	F, G, J, K	500	240	F, G, J, K	200	3000	F, G, J, K	50
1.9	B, C, D	500	22	F, G, J, K	500	270	F, G, J, K	200	3300	F, G, J, K	50
2.0	B, C, D	500	24	F, G, J, K	500	300	F, G, J, K	200	3600	F, G, J, K	50
2.2	B, C, D	500	27	F, G, J, K	500	330	F, G, J, K	200	3900	F, G, J, K	50
2.4	B, C, D	500	30	F, G, J, K	500	360	F, G, J, K	200	4300	F, G, J, K	50
2.7	B, C, D	500	33	F, G, J, K	500	390	F, G, J, K	200	4700	F, G, J, K	50
3.0	B, C, D	500	36	F, G, J, K	500	430	F, G, J, K	200	5000	F, G, J, K	50
3.3	B, C, D	500	39	F, G, J, K	500	470	F, G, J, K	200	5100	F, G, J, K	50
3.6	B, C, D	500	43	F, G, J, K	500	510	F, G, J, K	150			

TABLE VI: TC: C ($\pm 15\%$)

Cap. pF	Cap. Tol.	WVDC	Cap. pF	Cap. Tol.	WVDC	Cap. pF	Cap. Tol.	WVDC
5000	K, M, N	50	15000	K, M, N	50	47000	K, M, N	50
6800	K, M, N	50	18000	K, M, N	50	68000	K, M, N	50
8200	K, M, N	50	27000	K, M, N	50	82000	K, M, N	50
10000	K, M, N	50	33000	K, M, N	50	100000	K, M, N	50
12000	K, M, N	50	39000	K, M, N	50			



SQCS/CF RF Capacitors

Ceramic (0603/0805) Ultra Low ESR High Q Capacitors

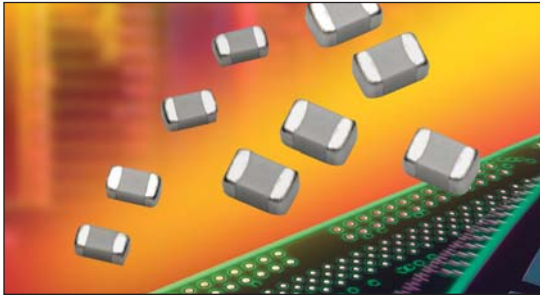

SQCS (0603) & SQCF (0805) are AVX's Ultra Low ESR microwave capacitors suitable for Base Station infrastructure applications requiring High Q and power handling capability.

Check for up-to-date CV Tables at <http://www.avx.com/docs/catalogs/sq.pdf>

HOW TO ORDER

SQ ┆	CS ┆	V ┆	A ┆	100 ┆	J ┆	A ┆	T ┆	1A ┆
AVX Style SQ	Case Size CS = 0603 CF = 0805	Voltage Code V = 250V	Temperature Coefficient Code A = 0±30ppm/°C	Capacitance EIA Capacitance Code in pF. First two digits = significant figures or "R" for decimal place. Third digit = number of zeros or after "R" significant figures.	Capacitance Tolerance Code A = ±.05 pF B = ±.1 pF C = ±.25 pF D = ±.5 pF F = ±1% G = ±2% J = ±5%	Failure Rate Code A = Not Applicable	Termination Style Code **1 = Pd/Ag **7 = Ag/Ni/Au J = Nickel Barrier Tin/Lead (60/40) **T = 100% Tin (Standard)	Packaging Code 1A = 7" Reel Unmarked ME = 7" Reel Marked *Vertical T&R available *500 piece reels available

**RoHS Compliant

TABLE I: TC: A (0±30PPM/°C) CASE SIZE S

Cap. pF	Cap. Tol.	WVDC	Cap. pF	Cap. Tol.	WVDC	Cap. pF	Cap. Tol.	WVDC
0.1	A, B	250	2.4	A, B, C	250	18	F, G, J	250
0.2	A, B	250	2.7	A, B, C	250	20	F, G, J	250
0.3	A, B	250	3.0	A, B, C	250	22	F, G, J	250
0.4	A, B	250	3.3	A, B, C	250	24	F, G, J	250
0.5	A, B, C	250	3.6	A, B, C	250	27	F, G, J	250
0.6	A, B, C	250	3.9	A, B, C	250	30	F, G, J	250
0.7	A, B, C	250	4.3	A, B, C	250	33	F, G, J	250
0.8	A, B, C	250	4.7	A, B, C	250	36	F, G, J	250
0.9	A, B, C	250	5.1	A, B, C	250	39	F, G, J	250
1.0	A, B, C	250	5.6	A, B, C	250	43	F, G, J	250
1.1	A, B, C	250	6.2	A, B, C	250	47	F, G, J	250
1.2	A, B, C	250	6.8	B, C, D	250	51	F, G, J	250
1.3	A, B, C	250	7.5	B, C, D	250	56	F, G, J	250
1.4	A, B, C	250	8.2	B, C, D	250	62	F, G, J	250
1.5	A, B, C	250	9.1	B, C, D	250	68	F, G, J	250
1.6	A, B, C	250	10	F, G, J	250	75	F, G, J	250
1.7	A, B, C	250	11	F, G, J	250	82	F, G, J	250
1.8	A, B, C	250	12	F, G, J	250	91	F, G, J	250
1.9	A, B, C	250	13	F, G, J	250	100	F, G, J	250
2.0	A, B, C	250	15	F, G, J	250			
2.2	A, B, C	250	16	F, G, J	250			

TABLE II: TC: A (0±30PPM/°C) CASE SIZE F

Cap. pF	Cap. Tol.	WVDC	Cap. pF	Cap. Tol.	WVDC	Cap. pF	Cap. Tol.	WVDC	Cap. pF	Cap. Tol.	WVDC
0.1	A, B	250	2.4	A, B, C	250	18	F, G, J	250	150	F, G, J	250
0.2	A, B	250	2.7	A, B, C	250	20	F, G, J	250	180	F, G, J	250
0.3	A, B	250	3.0	A, B, C	250	22	F, G, J	250	200	F, G, J	250
0.4	A, B	250	3.3	A, B, C	250	24	F, G, J	250	220	F, G, J	250
0.5	A, B, C	250	3.6	A, B, C	250	27	F, G, J	250	240	F, G, J	250
0.6	A, B, C	250	3.9	A, B, C	250	30	F, G, J	250			
0.7	A, B, C	250	4.3	A, B, C	250	33	F, G, J	250			
0.8	A, B, C	250	4.7	A, B, C	250	36	F, G, J	250			
0.9	A, B, C	250	5.1	A, B, C	250	39	F, G, J	250			
1.0	A, B, C	250	5.6	A, B, C	250	43	F, G, J	250			
1.1	A, B, C	250	6.2	A, B, C	250	47	F, G, J	250			
1.2	A, B, C	250	6.8	B, C, D	250	51	F, G, J	250			
1.3	A, B, C	250	7.5	B, C, D	250	56	F, G, J	250			
1.4	A, B, C	250	8.2	B, C, D	250	62	F, G, J	250			
1.5	A, B, C	250	9.1	B, C, D	250	68	F, G, J	250			
1.6	A, B, C	250	10	F, G, J	250	75	F, G, J	250			
1.7	A, B, C	250	11	F, G, J	250	82	F, G, J	250			
1.8	A, B, C	250	12	F, G, J	250	91	F, G, J	250			
1.9	A, B, C	250	13	F, G, J	250	100	F, G, J	250			
2.0	A, B, C	250	15	F, G, J	250	110	F, G, J	250			
2.2	A, B, C	250	16	F, G, J	250	120	F, G, J	250			



U Series RF Capacitors (RoHS)

C0G (NP0) Ceramic Low ESR Capacitors



“U” Series capacitors are C0G (NP0) chip capacitors specially designed for “Ultra” low ESR for applications in the communications market. Max ESR and effective capacitance are met on each value producing lot to lot uniformity. Sizes available are EIA chip sizes 0402, 0603, 0805, and 1210.

 Check for up-to-date CV Tables at <http://www.avx.com/docs/catalogs/useries.pdf>

HOW TO ORDER

0805	1	U	100	J	A	T	2	A
Case Size	Voltage Code	Dielectric = Ultra Low ESR	Capacitance	Capacitance Tolerance Code	Failure Rate Code	Termination	Packaging Code	Special Code
0402 0603 0805 1210	5 = 50V 1 = 100V 2 = 200V		EIA Capacitance Code in pF. First two digits = significant figures or “R” for decimal place. Third digit = number of zeros or after “R” significant figures.	B = ±0.1pF C = ±0.25pF D = ±0.5pF F = ±1% J = ±5% K = ±10% M = ±20%	A = Not Applicable	T = Plated Ni and Sn	2 = 7" Reel 4 = 13" Reel 9 = Bulk	A = Standard

Cap (pF)	Available Tolerance	Size			
		0402	0603	0805	1210
0.2	B,C	50V	N/A	N/A	N/A
0.3	↓	↓	↓	↓	↓
0.4	B,C	↓	↓	↓	↓
0.5	↓	↓	↓	↓	↓
0.6	B,C,D	↓	↓	↓	↓
0.7	↓	↓	↓	↓	↓
0.8	↓	↓	↓	↓	↓
0.9	B,C,D	↓	↓	↓	↓

Cap (pF)	Available Tolerance	Size			
		0402	0603	0805	1210
1.0	B,C,D	50V	200V	200V	200V
1.1	↓	↓	↓	↓	↓
1.2	↓	↓	↓	↓	↓
1.3	↓	↓	↓	↓	↓
1.4	↓	↓	↓	↓	↓
1.5	↓	↓	↓	↓	↓
1.6	↓	↓	↓	↓	↓
1.7	↓	↓	↓	↓	↓
1.8	↓	↓	↓	↓	↓
1.9	↓	↓	↓	↓	↓
2.0	↓	↓	↓	↓	↓
2.1	↓	↓	↓	↓	↓
2.2	↓	↓	↓	↓	↓
2.4	↓	↓	↓	↓	↓
2.7	↓	↓	↓	↓	↓
3.0	↓	↓	↓	↓	↓
3.3	↓	↓	↓	↓	↓
3.6	↓	↓	↓	↓	↓
3.9	↓	↓	↓	↓	↓
4.3	↓	↓	↓	↓	↓
4.7	↓	↓	↓	↓	↓
5.1	↓	↓	↓	↓	↓
5.6	↓	↓	↓	↓	↓
6.2	B,C,D	↓	↓	↓	↓
6.8	B,C,J,K,M	↓	↓	↓	↓

Cap (pF)	Available Tolerance	Size			
		0402	0603	0805	1210
7.5	B,C,J,K,M	50V	200V	200V	200V
8.2	↓	↓	↓	↓	↓
9.1	B,C,J,K,M	↓	↓	↓	↓
10	F,G,J,K,M	↓	↓	↓	↓
11	↓	↓	↓	↓	↓
12	↓	↓	↓	↓	↓
13	↓	↓	↓	↓	↓
15	↓	↓	↓	↓	↓
18	↓	↓	↓	↓	↓
20	↓	↓	↓	↓	↓
22	↓	↓	↓	↓	↓
24	↓	↓	↓	↓	↓
27	↓	↓	↓	↓	↓
30	↓	↓	↓	↓	↓
33	↓	↓	↓	↓	↓
36	↓	↓	↓	↓	↓
39	↓	↓	↓	↓	↓
43	↓	↓	↓	↓	↓
47	↓	↓	↓	↓	↓
51	↓	↓	↓	↓	↓
56	↓	↓	↓	↓	↓
68	↓	↓	↓	↓	↓
75	↓	↓	↓	↓	↓
82	↓	↓	↓	↓	↓
91	↓	↓	↓	↓	↓

Cap (pF)	Available Tolerance	Size			
		0402	0603	0805	1210
100	F,G,J,K,M	N/A	100V	200V	200V
110	↓	↓	50V	↓	↓
120	↓	↓	50V	↓	↓
130	↓	↓	N/A	200V	↓
140	↓	↓	↓	100V	↓
150	↓	↓	↓	↓	↓
160	↓	↓	↓	↓	↓
180	↓	↓	↓	↓	↓
200	↓	↓	↓	↓	↓
220	↓	↓	↓	↓	↓
270	↓	↓	↓	↓	↓
300	↓	↓	↓	↓	↓
330	↓	↓	↓	↓	↓
360	↓	↓	↓	↓	↓
390	↓	↓	↓	↓	↓
430	↓	↓	↓	↓	↓
470	↓	↓	↓	↓	↓
510	↓	↓	↓	↓	↓
560	↓	↓	↓	↓	↓
620	↓	↓	↓	↓	↓
680	↓	↓	↓	↓	↓
750	↓	↓	↓	↓	↓
820	↓	↓	↓	↓	↓
910	↓	↓	↓	↓	↓
1000	F,G,J,K,M	↓	↓	↓	↓



U Series RF Capacitors (Tin/Lead)

C0G (NP0) Ceramic Low ESR Capacitors



“U” Series capacitors are C0G (NP0) chip capacitors specially designed for “Ultra” low ESR for applications in the communications market. Max ESR and effective capacitance are met on each value producing lot to lot uniformity. Sizes available are EIA chip sizes 0402, 0603, 0805, and 1210.

Check for up-to-date CV Tables at <http://www.avx.com/docs/catalogs/useries.pdf>

HOW TO ORDER

- LD05**
Case Size
LD02 = 0402
LD03 = 0603
LD05 = 0805
LD10 = 1210
- 1**
Voltage Code
5 = 50V
1 = 100V
2 = 200V
- U**
Dielectric = Ultra Low ESR
- 100**
Capacitance
EIA Capacitance Code in pF.
First two digits = significant figures or “R” for decimal place.
Third digit = number of zeros or after “R” significant figures.
- J**
Capacitance Tolerance Code
B = ±0.1pF
C = ±0.25pF
D = ±0.5pF
F = ±1%
G = ±2%
J = ±5%
K = ±10%
M = ±20%
- A**
Failure Rate Code
A = Not Applicable
- B**
Termination
B = 5% min lead
- 2**
Packaging Code
2 = 7" Reel
4 = 13" Reel
9 = Bulk
- A**
Special Code
A = Standard

Cap (pF)	Available Tolerance	Size			
		LD02	LD03	LD05	LD10
0.2	B,C	50V	N/A	N/A	N/A
0.3	B,C	50V	N/A	N/A	N/A
0.4	B,C	50V	N/A	N/A	N/A
0.5	B,C	50V	N/A	N/A	N/A
0.6	B,C,D	50V	N/A	N/A	N/A
0.7	B,C,D	50V	N/A	N/A	N/A
0.8	B,C,D	50V	N/A	N/A	N/A
0.9	B,C,D	50V	N/A	N/A	N/A

Cap (pF)	Available Tolerance	Size			
		LD02	LD03	LD05	LD10
1.0	B,C,D	50V	200V	200V	200V
1.1	B,C,D	50V	200V	200V	200V
1.2	B,C,D	50V	200V	200V	200V
1.3	B,C,D	50V	200V	200V	200V
1.4	B,C,D	50V	200V	200V	200V
1.5	B,C,D	50V	200V	200V	200V
1.6	B,C,D	50V	200V	200V	200V
1.7	B,C,D	50V	200V	200V	200V
1.8	B,C,D	50V	200V	200V	200V
1.9	B,C,D	50V	200V	200V	200V
2.0	B,C,D	50V	200V	200V	200V
2.1	B,C,D	50V	200V	200V	200V
2.2	B,C,D	50V	200V	200V	200V
2.4	B,C,D	50V	200V	200V	200V
2.7	B,C,D	50V	200V	200V	200V
3.0	B,C,D	50V	200V	200V	200V
3.3	B,C,D	50V	200V	200V	200V
3.6	B,C,D	50V	200V	200V	200V
3.9	B,C,D	50V	200V	200V	200V
4.3	B,C,D	50V	200V	200V	200V
4.7	B,C,D	50V	200V	200V	200V
5.1	B,C,D	50V	200V	200V	200V
5.6	B,C,D	50V	200V	200V	200V
6.2	B,C,D	50V	200V	200V	200V
6.8	B,C,J,K,M	50V	200V	200V	200V

Cap (pF)	Available Tolerance	Size			
		LD02	LD03	LD05	LD10
7.5	B,C,J,K,M	50V	200V	200V	200V
8.2	B,C,J,K,M	50V	200V	200V	200V
9.1	B,C,J,K,M	50V	200V	200V	200V
10	F,G,J,K,M	50V	200V	200V	200V
11	F,G,J,K,M	50V	200V	200V	200V
12	F,G,J,K,M	50V	200V	200V	200V
13	F,G,J,K,M	50V	200V	200V	200V
15	F,G,J,K,M	50V	200V	200V	200V
18	F,G,J,K,M	50V	200V	200V	200V
20	F,G,J,K,M	50V	200V	200V	200V
22	F,G,J,K,M	50V	200V	200V	200V
24	F,G,J,K,M	50V	200V	200V	200V
27	F,G,J,K,M	50V	200V	200V	200V
30	F,G,J,K,M	50V	200V	200V	200V
33	F,G,J,K,M	50V	200V	200V	200V
36	F,G,J,K,M	50V	200V	200V	200V
39	F,G,J,K,M	50V	200V	200V	200V
43	F,G,J,K,M	50V	200V	200V	200V
47	F,G,J,K,M	50V	200V	200V	200V
51	F,G,J,K,M	50V	200V	200V	200V
56	F,G,J,K,M	50V	200V	200V	200V
68	F,G,J,K,M	50V	200V	200V	200V
75	F,G,J,K,M	50V	200V	200V	200V
82	F,G,J,K,M	50V	200V	200V	200V
91	F,G,J,K,M	50V	200V	200V	200V

Cap (pF)	Available Tolerance	Size			
		LD02	LD03	LD05	LD10
100	F,G,J,K,M	N/A	100V	200V	200V
110	F,G,J,K,M	N/A	100V	200V	200V
120	F,G,J,K,M	N/A	50V	200V	200V
130	F,G,J,K,M	N/A	N/A	200V	200V
140	F,G,J,K,M	N/A	N/A	100V	200V
150	F,G,J,K,M	N/A	N/A	100V	200V
160	F,G,J,K,M	N/A	N/A	100V	200V
180	F,G,J,K,M	N/A	N/A	N/A	200V
200	F,G,J,K,M	N/A	N/A	N/A	200V
220	F,G,J,K,M	N/A	N/A	N/A	200V
270	F,G,J,K,M	N/A	N/A	N/A	200V
300	F,G,J,K,M	N/A	N/A	N/A	200V
330	F,G,J,K,M	N/A	N/A	N/A	200V
360	F,G,J,K,M	N/A	N/A	N/A	200V
390	F,G,J,K,M	N/A	N/A	N/A	200V
430	F,G,J,K,M	N/A	N/A	N/A	200V
470	F,G,J,K,M	N/A	N/A	N/A	200V
510	F,G,J,K,M	N/A	N/A	N/A	200V
560	F,G,J,K,M	N/A	N/A	N/A	200V
620	F,G,J,K,M	N/A	N/A	N/A	200V
680	F,G,J,K,M	N/A	N/A	N/A	200V
750	F,G,J,K,M	N/A	N/A	N/A	200V
820	F,G,J,K,M	N/A	N/A	N/A	200V
910	F,G,J,K,M	N/A	N/A	N/A	200V
1000	F,G,J,K,M	N/A	N/A	N/A	200V



HQ Series, High Q, High RF Power Chips

For 600V to 7200V Application



Hi-Q®, High RF Power, Surface Mount and Leaded MLC Capacitors from AVX Corporation are characterized with ultra-low ESR and dissipation factor at high frequencies. They are designed to handle high power and high voltage levels for applications in RF power amplifiers, inductive heating, high magnetic field environments (MRI coils), medical and industrial electronics.

Check for up-to-date CV Tables at <http://www.avx.com/docs/catalogs/hi-q.pdf>

HOW TO ORDER

HQCC	A	A	271	J	A	T	1	A
AVX Style HQCC HQCE	Voltage C = 600V A = 1000V S = 1500V G = 2000V W = 2500V H = 3000V J = 4000V K = 5000V M = 7200V	Temperature Coefficient COG = A	Capacitance Code (2 significant digits + no. of zeros) Examples: 4.7 pF = 4R7 10 pF = 100 100 pF = 101 1,000 pF = 102	Capacitance Tolerance C = ±0.25pF (<13pF) D = ±0.50pF (<25pF) F = ±1% (≥25pF) G = ±2% (≥13pF) J = ±5% K = ±10% M = ±20%	Test Level A = Standard	Termination* 1 = Pd/Ag T = Plated Ni and Sn (RoHS Compliant) J = 5% Min Pb M = Microstip (non-mag) A = Axial (non-mag)	Packaging 1 = 7" Reel 3 = 13" Reel 9 = Bulk	Special Code A = Standard

DIELECTRIC PERFORMANCE CHARACTERISTICS

Capacitance Range	3.3pF to 6,800pF (25°C, 1.0 ±0.2 Vrms at 1kHz, for ≤ 1000 pF use 1MHz)
Capacitance Tolerances	±0.25pF, ±0.50pF, ±1%, ±2%, ±5%, ±10%, ±20%
Dissipation Factor 25°C	0.1% Max (+25°C, 1.0 ±0.2 Vrms at 1kHz, for ≤ 1000 pF use 1MHz)
Operating Temperature Range	-55°C to +125°C
Temperature Characteristic	COG: 0 ± 30 ppm/°C (-55°C to +125°C)
Voltage Ratings	600, 1000, 1500, 2000, 2500, 3000, 4000, 5000, 7200VDC
Insulation Resistance	100K MΩ min. @ +25°C and 500VDC 10K MΩ min. @ +125°C and 500VDC
Dielectric Strength	120% of rated WVDC

HIGH VOLTAGE CAPACITANCE VALUES (pF)

Style	600 WDC min./max.	1000 WVDC min./max.	1500 WVDC min./max.	2000 WVDC min./max.	2500 WVDC min./max.	3000 WVDC min./max.	4000 WVDC min./max.	5000 WVDC min./max.	7200 WVDC min./max.
HQCC	2,200 - 2,700	1,500 - 1,800	820 - 1,200	470 - 680	330 - 390	4.7 - 270	3.3 - 6.8		
HQCE	3.3 - 6,800	3.3 - 4,700	3.3 - 2,700	3.3 - 1,800	3.3 - 1,000	3.3 - 680	3.3 - 390	3.3 - 180	3.3 - 100



HQL Series, High Q, High RF Power

Ribbon Ledged MLC Capacitors

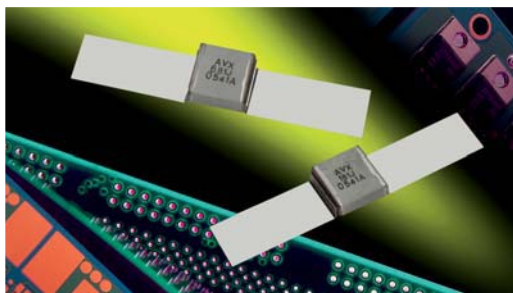

Hi-Q®, High RF Power, Ribbon Ledged MLC Capacitors from AVX Corporation are characterized with ultra-low ESR and dissipation factor at high frequencies. The HQL-style parts are constructed using non-magnetic materials. They are designed to handle high power and high voltage levels for applications in RF power amplifiers, inductive heating, high magnetic field environments (MRI coils), medical and industrial electronics.

Check for up-to-date CV Tables at
<http://www.avx.com/docs/catalogs/hi-ql.pdf>

HOW TO ORDER

HQLC 	A 	A 	271 	J 	A 	A
AVX Style HQLC HQLE	Voltage C = 600V/630 A = 1000V S = 1500V G = 2000V W = 2500V H = 3000V J = 4000V K = 5000V M = 7200V	Temperature Coefficient COG = A	Capacitance Code (2 significant digits + no. of zeros) Examples: 4.7 pF = 4R7 10 pF = 100 100 pF = 101 1,000 pF = 102	Capacitance Tolerance C = ±0.25pF (<13pF) D = ±0.50pF (<25pF) F = ±1% (≥25pF) G = ±2% (≥13pF) J = ±5% K = ±10% M = ±20%	Test Level A = Standard	Lead Style A = Axial Ribbon M = Microstrip

DIELECTRIC PERFORMANCE CHARACTERISTICS

Capacitance Range	3.3pF to 6,800pF (25°C, 1.0 ±0.2 Vrms at 1kHz, for ≤ 1000 pF use 1MHz)
Capacitance Tolerances	±0.25pF, ±0.50pF, ±1%, ±2%, ±5%, ±10%, ±20%
Dissipation Factor 25°C	0.1% Max (+25°C, 1.0 ±0.2 Vrms at 1kHz, for ≤ 1000 pF use 1MHz)
Operating Temperature Range	-55°C to +125°C
Temperature Characteristic	COG: 0 ± 30 ppm/°C (-55°C to +125°C)
Voltage Ratings	600, 1000, 1500, 2000, 2500, 3000, 4000, 5000, 7200VDC
Insulation Resistance	100K MΩ min. @ +25°C and 500VDC 10K MΩ min. @ +125°C and 500VDC
Dielectric Strength	120% of rated WVDC

HIGH VOLTAGE CAPACITANCE VALUES (pF)

Style	600 WDC min./max.	1000 WVDC min./max.	1500 WVDC min./max.	2000 WVDC min./max.	2500 WVDC min./max.	3000 WVDC min./max.	4000 WVDC min./max.	5000 WVDC min./max.	7200 WVDC min./max.
HQLC	2,200 - 2,700	1,500 - 1,800	820 - 1,200	470 - 680	330 - 390	4.7 - 270	3.3 - 6.8		
HQLE	3.3 - 6,800	3.3 - 4,700	3.3 - 2,700	3.3 - 1,800	3.3 - 1,000	3.3 - 680	3.3 - 390	3.3 - 180	3.3 - 100



GX Series

Ultra Broad Band Capacitor



ADVANTAGES

- Ultra-Broadband performance
- Ultra-Low Insertion Loss
- X5R & X7S Characteristics
- Low Return Loss

APPLICATIONS

- Semi-Conductor Data Communications Customers
- Receiver Optical Sub-Assemblies
- Transimpedance Amplifier Customers
- Test Equipment Manufactures

[Check for up-to-date CV Tables at http://www.avx.com/docs/catalogs/gx.pdf](http://www.avx.com/docs/catalogs/gx.pdf)

The GX Series was developed specifically to address DC Blocking issues from ~16KHz (-3dB roll-off) to 40GHz. Most applications will experience resonance-free insertion loss of <0.5dB thru at least 40GHz. Insertion loss at higher frequencies is in part dependent on installation parameters. Using AVX's patented precision thin film termination process, the part is designed to be completely orientation insensitive with a standard EIA 0402 footprint to minimize board space requirements. Both Ni/Sn and Ni/Au

terminations are available to cover a wide range of attachment processes. All GX parts are RoHS compliant.

Au terminated units are wire bondable. Users may, therefore, find these devices equally useful in bypass applications when wire bonding is a necessary part of the manufacturing process.

More information can be obtained by contacting the factory or your local AVX representative.

HOW TO ORDER

GX 	02 	YD 	104 	K 	A 	T 	2
Style	Case Size 02 = 0402	Voltage/Dielectric YD = 16Vdc/X5R ZZ = 10Vdc/X7S	Capacitance 104 = 0.1µF EIA Cap Code in pF	Tolerance K = ±10% M = ±20%	Failure Rate A = Std	Termination T = Ni-Sn (Standard) 7 = Ni-Au	Packaging 2 = 4000 pcs, 7" T&R 2-500 = 500 pcs, 7" T&R 2-1000 = 1000 pcs, 7" T&R

ELECTRICAL SPECIFICATIONS

Capacitance	0.1 µF ± 10%, 0.1 µF ± 20%
Voltage Rating/Operating Temperature	16 VDC @ 85°C; 10 VDC @ 125°C
Dielectric Withstanding Voltage	250% WVDC
Insulation Resistance	10,000 Meg Ohms @ 25°C; 1,000 Meg Ohms @ 125°C
Temperature Coefficient	16 VDC X5R (± 15%); 10 VDC X7S (± 22%)

Film Chip Capacitors

CB-PET Series High Temperature PET Dielectric

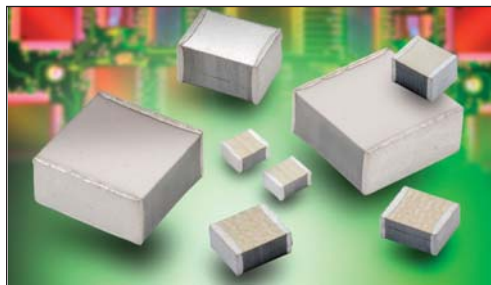

Film chip capacitor using a naked and stacked construction with metallized High Temperature PET (polyethylene terephthalate).

- Use of high temperature dielectric films makes these capacitors suitable for IR or vapor phase reflow processes. This chip is built without specific encapsulation.
- The intrinsic elasticity of the dielectric film allows an excellent compatibility of the capacitor with all types of material for printed circuit boards.
- The self-healing property of film technology results in a safe open failure mode and better overall reliability.
- Excellent thermal shock resistance
- Low dissipation factor, ESR & ESL
- No piezoelectric effect
- Available in tape and reel suitable for automatic placement
- Non-polar construction

 Check for up-to-date CV Tables at <http://www.avx.com/docs/catalogs/cb-petht.pdf>

HOW TO ORDER

CB Type SMD Lead Free	04 Size 04 = 2220 05 = 2824 16 = 4030 17 = 5040 18 = 6054	2 Dielectric 2 = PET-HT	G Voltage D = 50/63V E = 100V G = 250V I = 400V K = 630V	0104 Capacitance EIA Code 1st digit: 0 2nd & 3rd digit: the 2nd significant figures of the capacitance value 4th digit: the number of zeros to be added to the capacitance value	K Tolerance K = 10% J = 5%	-- Suffix Packaging -- = Bulk BC = tape & reel diameter: 330mm
--	--	--	---	---	--	---

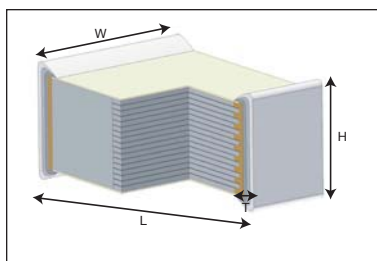

Size Code	Equivalent Size	Length (L)	Width (W)
04	2220	5.8±0.50 (0.228±0.020)	5.0±0.50 (0.197±0.020)
05	2824	7.2±0.50 (0.283±0.020)	6.1±0.50 (0.240±0.020)
16	4030	10.5±0.60 (0.413±0.024)	7.6±0.80 (0.299±0.031)
17	5040	12.8±0.60 (0.504±0.024)	10.2±0.80 (0.402±0.031)
18	6054	15.3±0.60 (0.602±0.024)	13.7±0.80 (0.539±0.031)

millimeters (inches)

VOLTAGE (Vdc / Vac)											
Capacitance		63 Vdc / 40 Vac		100 Vdc / 63 Vac		250 Vdc - 160 Vac		400 Vdc / 200 Vac		630 Vdc / 250 Vac	
Value	Cap Code	Size Code	H max	Size Code	H max	Size Code	H max	Size Code	H max	Size Code	H max
0.010µF	0103							2220	2.4	2220	2.8
0.015	0153							2220	2.4	2220	4.0
0.022	0223							2220	3.0	2824	3.4
0.033	0333							2220	4.2	2824	5.0
0.047	0473					2220	3.0	2824	4.5	4030	3.6
0.068	0683					2220	4.1	4030	3.6	4030	5.2
0.100	0104					2220	4.55	4030	4.7	5040	5.0
0.150	0154					2824	4.3	5040	4.6	5040	6.9
0.220	0224			2220	3.3	2824	4.9	6054	4.0	6054	5.8
0.330	0334	2220	3.3	2220	4.0	4030	5.6	6054	5.6		
0.470	0474	2220	3.5	2824	4.4	4030	6.15				
0.680	0684	2220	4.0	2824	5.2	5040	6.5				
1.0µF	0105	2220	4.0	2824	5.7	6054	6.0				
1.5	0155	2824	5.4	4030	6.1	6054	7.0				
2.2	0225	4030	5.7	5040	5.5						
3.3	0335	6054	5.5	6054	5.2						
4.7	0475	6054	4.9	6054	7.1						

For other values : upon request



Film Chip Capacitors

CB-PEN Series PEN Dielectric

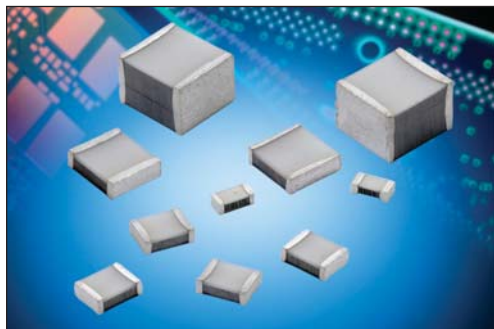

Film chip capacitor using a naked and stacked construction with metallized PEN (polyethylene naphthalate).

- Use of high temperature dielectric films makes these capacitors suitable for IR or vapor phase reflow processes. This chip is built without specific encapsulation.
- The intrinsic elasticity of the dielectric film allows an excellent compatibility of the capacitor with all types of material for printed circuit boards.
- The self-healing property of film technology results in a safe open circuit failure mode and better overall reliability.
- Excellent thermal shock resistance
- Low dissipation factor, ESR & ESL
- No piezoelectric effect
- Available in tape and reel suitable for automatic placement
- Non-polar construction.

Check for up-to-date CV Tables at <http://www.avx.com/docs/catalogs/cb-pen.pdf>

HOW TO ORDER

CB Type SMD Lead Free	01 Size 01 = 1206 02 = 1210 03 = 1812 04 = 2220	7 Dielectric 7 = PEN	D Voltage C = 25V D = 50/63V E = 100V G = 250V I = 400V K = 630V	0103 Capacitance EIA Code 1st digit: 0 2nd & 3rd digit: the 2nd significant figures of the capacitance value 4th digit: the number of zeros to be added to the capacitance value	J Tolerance K = 10% J = 5%	BA Suffix Packaging -- = Bulk BA = tape & reel diameter: 180mm BC = tape & reel diameter: 330mm
------------------------------------	---	-----------------------------------	--	--	--	--

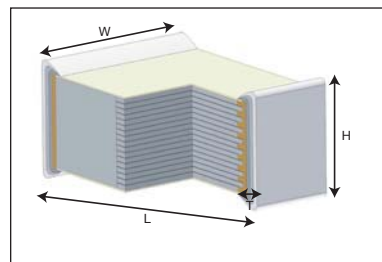

Size Code	Equivalent Size	Length (L)	Width (W)
01	1206	3.3±0.30 (0.130±0.012)	1.6±0.30 (0.063±0.012)
02	1210	3.3±0.30 (0.130±0.012)	2.5±0.30 (0.098±0.012)
03	1812	4.7±0.50 (0.185±0.020)	3.2±0.50 (0.126±0.020)
04	2220	5.8±0.50 (0.228±0.020)	5.0±0.50 (0.197±0.020)
05	2824	7.2±0.50 (0.283±0.020)	6.1±0.50 (0.240±0.020)
16	4030	10.5±0.60 (0.413±0.024)	7.6±0.80 (0.299±0.031)
17	5040	12.8±0.60 (0.504±0.024)	10.2±0.80 (0.402±0.031)
18	6054	15.3±0.60 (0.602±0.024)	13.7±0.80 (0.539±0.031)

VOLTAGE (Vdc / Vac)															
Capacitance		25 Vdc / 16 Vac		50-63 Vdc / 40 Vac				100 Vdc - 63 Vac		250 Vdc / 160 Vac		400 Vdc / 200 Vac		630 Vdc / 250 Vac	
Value	Cap Code	Size Code	H max	Size Code	Size Code	H max	H max	Size Code	H max	Size Code	H max	Size Code	H max	Size Code	H max
0.001µF	0102	1206	1.15	1206	1812	1.15	1.9	1206	1.15	1812	2.0	1812	2.0	1812	2.0
0.0015	0152	1206	1.15	1206	1812	1.15	1.9	1206	1.15	1812	2.0	1812	2.0	1812	2.0
0.0022	0222	1206	1.15	1206	1812	1.15	1.9	1206	1.15	1812	2.0	1812	2.0	1812	2.0
0.0033	0332	1206	1.15	1206	1812	1.15	1.9	1206	1.15	1812	2.0	1812	2.0	1812	2.0
0.0047	0472	1206	1.15	1206	1812	1.15	2.0	1206	1.15	1812	2.0	1812	2.0	1812	2.5
0.0068	0682	1206	1.15	1206	1812	1.15	2.0	1206	1.15	1812	2.0	1812	2.0	2220	2.0
0.010	0103	1206	1.15	1206	1812	1.15	2.0	1206	1.15	1812	2.0	2220	1.9	2220	2.4
0.015	0153	1206	1.15	1206	1812	1.15	2.4	1210	1.8	1812	2.4	2220	2.2	2220	3.4
0.022	0223	1206	1.15	1206	1812	1.15	2.0	1210	1.8	1812	2.9	2220	2.8	2824	3.4
0.033	0333	1210	1.8	1210	1812	1.8	2.0	1812	2.0	2220	2.2	2220	3.9	2824	4.8
0.047	0473	1210	1.8	1210	1812	1.8	2.7	1812	2.6	2220	2.9	2824	3.2	4030	4.0
0.068	0683	1210	1.8	1210	1812	1.8	2.0	1812	2.0	2220	4.0	2824	4.4	4030	5.5
0.100	0104	1210	2.3	1210	1812	2.3	2.8	1812	3.0	2220	4.5	4030	5.3	5040	5.2
0.150	0154			1812		2.0		2220	3.3	2824	4.7	4030	6.0	5040**	6.9
0.220	0224			1812		3.0		2220	4.0	2824	5.7	5040	5.0	6054	6.0
0.330	0334			2220		4.0		2220	4.2	4030	6.1	6054	5.9		
0.470	0474			2220		4.0		2824*	4.5	5040	5.5	6054	6.5		
0.680	0684			2220		3.9		2824*	4.5	6054	4.6				
1	0105			2824*		4.7		4030	6.0	6054	6.4				
1.5	0155			2824*		4.7		5040	5.5						
2.2	0225			4030		6.1		5040	6.9						
3.3	0335			6054		5.3		6054	7.1						
4.7	0475			6054		7.2									

For other values: upon request
 *Special length: 7.3 +0.7/-0.3 (0.287 +0.028/-0.012)
 **Only available in tolerance 10%

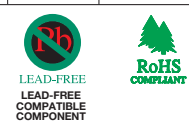

Film Chip Capacitors

CB-PPS Series PPS Dielectric

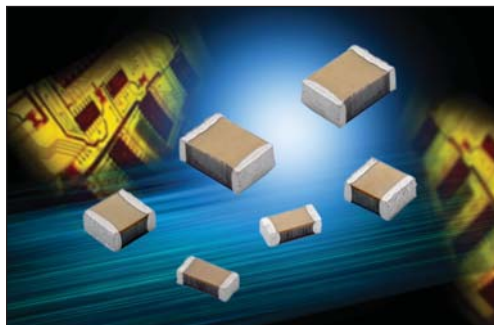

Film chip capacitor using a naked and stacked construction with metallized PPS (polyphenylene sulfide film).

- Applicable for both flow and reflow soldering
- Very constant Capacitance value with temperature
- Low dielectric absorption
- The intrinsic elasticity of the dielectric film provides an excellent compatibility of the capacitor with all types of material for printed circuit boards
- Excellent thermal shock resistance
- Low dissipation factor, ESR and ESL
- No piezoelectric effect
- Available in tape and reel suitable for automatic placement
- Non-polar construction.



Check for up-to-date CV Tables at
<http://www.avx.com/docs/catalogs/cb-pps.pdf>

HOW TO ORDER

CB Type SMD Lead Free	02 Size 01 = 1206 02 = 1210 03 = 1812	8 Dielectric 8 = PPS	B Voltage B = 16V D = 50V	0104 Capacitance EIA Code 1st digit: 0 2nd & 3rd digit: the 2nd significant figures of the capacitance value 4th digit: the number of zeros to be added to the capacitance value	G Tolerance G = 2% J = 5% K = 10%	-- Suffix Packaging -- = Bulk BA = tape & reel diameter: 180mm
--	--	---	---	---	--	---

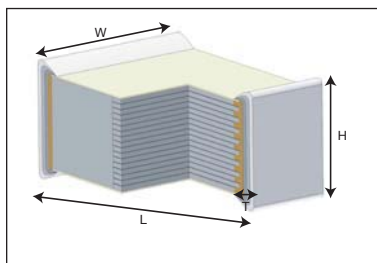

	millimeters (inches)		
Size Code	Equivalent Size	Length (L)	Width (W)
01	1206	3.3±0.30 (0.130±0.012)	1.6±0.30 (0.063±0.012)
02	1210	3.3±0.30 (0.130±0.012)	2.5±0.30 (0.098±0.012)
03	1812	4.5±0.50 (0.177±0.020)	3.2±0.50 (0.126±0.020)

VOLTAGE (Vdc / Vac)					
Capacitance		16 Vdc / 10 Vac		50 Vdc / 40 Vac	
Value	Cap Code	Size Code	H max	Size Code	H max
0.001µF	0102	1206	1.15	1206	1.15
0.0015	0152	1206	1.15	1206	1.15
0.0022	0222	1206	1.15	1206	1.15
0.0033	0332	1206	1.15	1206	1.15
0.0047	0472	1206	1.15	1206	1.15
0.0068	0682	1206	1.15	1206	1.15
0.010	0103	1206	1.15	1206	1.15
0.015	0153	1206	1.15	1210	1.8
0.022	0223	1206	1.15	1210	1.8
0.033	0333	1206	1.15	1210	2.1
0.047	0473	1210	1.8	1812	2.4
0.068	0683	1210	1.8	1812	2.4
0.100	0104	1210	1.8	1812	2.4
0.150	0154	1812	2.3		
0.180	0184	1812	2.5		

For other values : upon request



SR Series

SkyCap® Radial Conformal Coated NP0 Dielectric

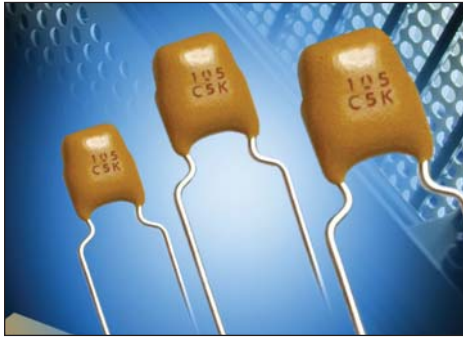

AVX SR Series is a conformally coated radial lead capacitor. We offer NP0, X7R, and Z5U dielectrics standard. Alternative dielectrics are also available upon request. Voltages range from 50V to 500V, with lower voltages available as well.

Check for up-to-date CV Tables at <http://www.avx.com/docs/catalogs/skycap.pdf>

HOW TO ORDER

SR21	5	A	104	F	A	R
AVX Style	Voltage	Temperature Coefficient	Capacitance	Capacitance Tolerance	Failure Rate	Leads
SR15 SR20 SR21 SR22 SR27 SR30 SR40 SR50	5 = 50V 1 = 100V 2 = 200V	A = COG (NP0)	First two digits are the significant figures of capacitance. Third digit indicates the additional number of zeros. For example, order 100,000 pF as 104. (For values below 10pF use "R" in place of decimal point, e.g., 1R4 = 1.4pF.)	C = ±.25pF D = ±.5pF F = ±1% (>50pF only) G = ±2% (>25pF only) J = ±5% K = ±10%	A = Not Applicable	R = RoHS

COG (NP0) Dielectric

AVX Style		SR15			SR20			SR21			SR22			SR27			SR30		SR40		SR50	
AVX "Insertable"		SR07			SR29			SR59			N/A			N/A			SR65		SR75		N/A	
Cap. in.*	Industry Preferred Values in Blue	WVDC			WVDC			WVDC			WVDC			WVDC			WVDC		WVDC		WVDC	
		200	100	50	200	100	50	200	100	50	200	100	50	200	100	50	100	50	100	50	100	50
1.0-9.9	SR151A1R0DAR																					
10	SR151A100KAR																					
15	SR.....A150KAR																					
22	SR.....A220KAR																					
33	SR.....A330KAR																					
39	SR.....A390KAR																					
47	SR.....A470KAR																					
68	SR.....A680KAR																					
100	SR151A101KAR																					
150	SR.....A151KAR																					
220	SR.....A221KAR																					
330	SR.....A331KAR																					
390	SR.....A391KAR																					
470	SR.....A471KAR																					
680	SR.....A681KAR																					
1000	SR211A102KAR																					
1500	SR.....A152KAR																					
2200	SR.....A222KAR																					
3900	SR.....A392KAR																					
4700	SR.....A472KAR																					
6800	SR.....A682KAR																					
8200	SR.....A822KAR																					
10,000	SR305A103KAR																					
15,000	SR.....A153KAR																					
22,000	SR.....A223KAR																					
33,000	SR.....A333KAR																					
39,000	SR.....A393KAR																					
47,000	SR.....A473KAR																					
68,000	SR.....A683KAR																					
100,000	SR.....A104KAR																					

For other styles, voltages, tolerances and lead lengths see Part No. Codes or contact factory.

NOTE: Capacitance Ranges available for SR12 same as SR15
SR62 same as SR21
SR64 same as SR30
SR89 same as SR21

*Other capacitance values available upon special request.

= Industry preferred values
 = SR20 only

SR Series

SkyCap® Radial Conformal Coated X7R Dielectric

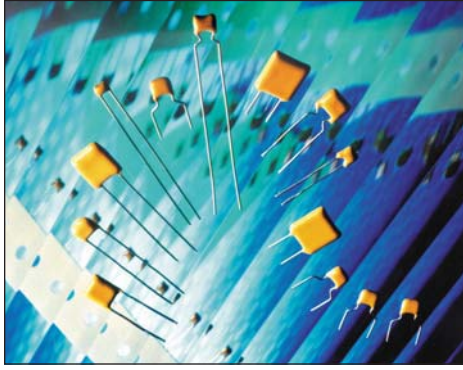

AVX SR Series is a conformally coated radial leaded capacitor. We offer NP0, X7R, and Z5U dielectrics standard. Alternative dielectrics are also available upon request. Voltages range from 50V to 500V, with lower voltages available as well.

Check for up-to-date CV Tables at <http://www.avx.com/docs/catalogs/skycap.pdf>

HOW TO ORDER

SR21	5	C	104	M	A	R
AVX Style	Voltage	Temperature Coefficient	Capacitance	Capacitance Tolerance	Failure Rate	Leads
SR15 SR20 SR21 SR22 SR27 SR30 SR40 SR50	5 = 50V 1 = 100V 2 = 200V	C = X7R	First two digits are the significant figures of capacitance. Third digit indicates the additional number of zeros. For example, order 100,000 pF as 104. (For values below 10pF use "R" in place of decimal point, e.g., 1R4 = 1.4pF.)	J = ±5% K = ±10% M = ±20%	A = Not Applicable	R = RoHS

X7R Dielectric

AVX Style	AVX "Insertable"	Width (W)	Height (H)	Thickness (T)	Lead Spacing (L.S.)	Lead Diameter (L.D.)	SR15			SR20			SR21			SR22		SR27		SR30			SR40			SR50								
							WVDC	100	50	WVDC	100	50	WVDC	100	50	WVDC	50	WVDC	100	50	WVDC	100	50	WVDC	100	50	WVDC	100	50					
470	SR...C471KAR																																	
1000	SR155C102KAR																																	
1500	SR...C152KAR																																	
2200	SR...C222KAR																																	
3300	SR...C332KAR																																	
4700	SR...C472KAR																																	
6800	SR...C682KAR																																	
10,000	SR215C103KAR																																	
15,000	SR...C153KAR																																	
22,000	SR...C223KAR																																	
33,000	SR...C333KAR																																	
47,000	SR...C473KAR																																	
68,000	SR...C683KAR																																	
100,000	SR215C104KAR																																	
150,000	SR...C154KAR																																	
220,000	SR215C224KAR																																	
330,000	SR...C334KAR																																	
390,000	SR...C394KAR																																	
470,000	SR305C474KAR																																	
1.0 µF	SR305C105KAR																																	
2.2 µF	SR405C225KAR																																	
2.7 µF	SR505C275KAR																																	
4.7 µF	SR505C475KAR																																	

For other styles, voltages, tolerances and lead lengths see Part No. Codes or contact factory.

*Other capacitance values available upon special request.

- = Industry preferred values
- = SR20 only
- = Extended range
- = Extended range, SR20 only
- = Extended range with 0.150" thickness maximum

NOTE: Capacitance Ranges available for SR12 same as SR15
SR62 same as SR21
SR64 same as SR30
SR89 same as SR21

SR Series

SkyCap® Radial Conformal Coated Z5U Dielectric

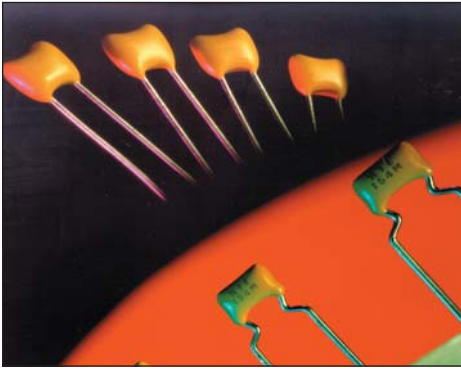

AVX SR Series is a conformally coated radial lead capacitor. We offer NP0, X7R, and Z5U dielectrics standard. Alternative dielectrics are also available upon request. Voltages range from 50V to 500V, with lower voltages available as well.

Check for up-to-date CV Tables at <http://www.avx.com/docs/catalogs/skycap.pdf>

HOW TO ORDER

SR21	5	E	104	M	A	R
↓	↓	↓	↓	↓	↓	↓
AVX Style SR15 SR20 SR21 SR22 SR27 SR30 SR40 SR50	Voltage 5 = 50V 1 = 100V	Temperature Coefficient E = Z5U	Capacitance First two digits are the significant figures of capacitance. Third digit indicates the additional number of zeros. For example, order 100,000 pF as 104. (For values below 10pF use "R" in place of decimal point, e.g., 1R4 = 1.4pF.)	Capacitance Tolerance M = ±20% Z = +80% -20%	Failure Rate A = Not Applicable	Leads R = RoHS

Z5U Dielectric

AVX Style		SR15	SR20	SR21	SR22	SR27	SR30	SR40	SR50				
AVX "Insertable"		SR07	SR29	SR59	N/A	N/A	SR65	SR75	N/A				
Cap. in.* pF	Industry Preferred Values in Blue	WVDC		WVDC		WVDC		WVDC		WVDC		WVDC	
		100	50	100	50	100	50	100	50	100	50	100	50
10,000	SR155E103ZAR	■											
47,000	SR.....E473ZAR	■											
100,000	SR215E104ZAR	■											
150,000	SR.....E154ZAR		■										
220,000	SR215E224ZAR		■										
330,000	SR215E334ZAR		■										
470,000	SR215E474ZAR		■										
680,000	SR.....E684ZAR		■										
1.0 µF	SR.....105ZAR		■										
1.5 µF	SR30E155ZAR		■										
2.2 µF	SR30E225ZAR		■										
3.3 µF	SR30E335ZAR		■										
4.7 µF	SR30E475ZAR		■										

For other styles, voltages, tolerances and lead lengths see Part No. Codes or contact factory.

*Other capacitance values available upon special request.

■ = Industry preferred values
 ▨ = SR20 only

SL Series

SkyCap® Radial Conformal Coated NP0 Dielectric

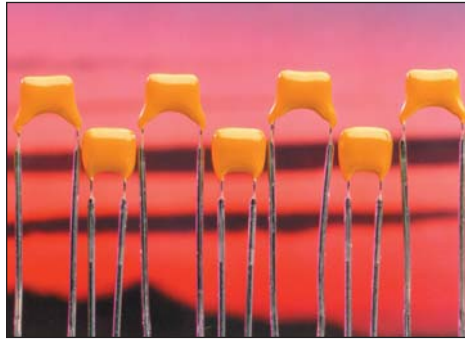

AVX SL Series is a conformally coated radial lead capacitor. We offer NP0, X7R, and Z5U dielectrics standard. Alternative dielectrics are also available upon request. Voltages range from 50V to 500V, with lower voltages available as well.

Check for up-to-date CV Tables at <http://www.avx.com/docs/catalogs/skycap.pdf>

HOW TO ORDER

SL21	5	A	104	F	A	B
AVX Style	Voltage	Temperature Coefficient	Capacitance	Capacitance Tolerance	Failure Rate	Leads
SL15 SL20 SL21 SL22 SL27 SL30 SL40 SL50	5 = 50V 1 = 100V 2 = 200V	A = COG (NP0)	First two digits are the significant figures of capacitance. Third digit indicates the additional number of zeros. For example, order 100,000 pF as 104. (For values below 10pF use "R" in place of decimal point, e.g., 1R4 = 1.4pF)	C = ±.25pF D = ±.5pF F = ±1% (>50pF only) G = ±2% (>25pF only) J = ±5% K = ±10%	A = Not Applicable	B = Tin/Lead

COG (NP0) Dielectric

AVX Style	SL15	SL20	SL21	SL22	SL27	SL30	SL40	SL50											
AVX "Insertable"	SL07	SL29	SL59	N/A	N/A	SL65	SL75	N/A											
Cap. in.* pF	WVDC			WVDC			WVDC			WVDC			WVDC			WVDC			
Industry Preferred Values in Blue	200	100	50	200	100	50	200	100	50	200	100	50	100	50	100	50	100	50	
1.0-9.9 10 15	SL151A1R0DAB SL151A100KAB SL_____A150KAB																		
22 33 39	SL_____A220KAB SL_____A330KAB SL_____A390KAB																		
47 68 100	SL_____A470KAB SL_____A680KAB SL151A101KAB																		
150 220 330	SL_____A151KAB SL_____A221KAB SL_____A331KAB																		
390 470 680	SL_____A391KAB SL_____A471KAB SL_____A681KAB																		
1000 1500 2200	SL211A102KAB SL_____A152KAB SL_____A222KAB																		
3900 4700 6800	SL_____A392KAB SL_____A472KAB SL_____A682KAB																		
8200 10,000 15,000	SL_____A822KAB SL305A103KAB SL_____A153KAB																		
22,000 33,000 39,000	SL_____A223KAB SL_____A333KAB SL_____A393KAB																		
47,000 68,000 100,000	SL_____A473KAB SL_____A683KAB SL_____A104KAB																		

For other styles, voltages, tolerances and lead lengths see Part No. Codes or contact factory.

NOTE: Capacitance Ranges available for SL12 same as SL15
SL62 same as SL21
SL64 same as SL30
SL89 same as SL21

*Other capacitance values available upon special request.

= Industry preferred values
 = SL20 only

SL Series

SkyCap® Radial Conformal Coated X7R Dielectric

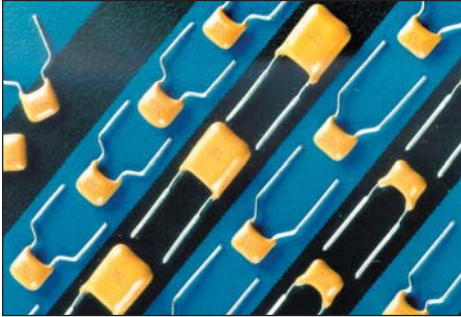

AVX SL Series is a conformally coated radial lead capacitor. We offer NP0, X7R, and Z5U dielectrics standard. Alternative dielectrics are also available upon request. Voltages range from 50V to 500V, with lower voltages available as well.

Check for up-to-date CV Tables at <http://www.avx.com/docs/catalogs/skycap.pdf>

HOW TO ORDER

SL21	5	C	104	M	A	B
AVX Style	Voltage	Temperature Coefficient	Capacitance	Capacitance Tolerance	Failure Rate	Leads
SL15 SL20 SL21 SL22 SL27 SL30 SL40 SL50	5 = 50V 1 = 100V 2 = 200V	C = X7R	First two digits are the significant figures of capacitance. Third digit indicates the additional number of zeros. For example, order 100,000 pF as 104. (For values below 10pF use "R" in place of decimal point, e.g., 1R4 = 1.4pF.)	J = ±5% K = ±10% M = ±20%	A = Not Applicable	B = Tin/Lead

X7R Dielectric

AVX Style	SL15	SL20	SL21	SL22	SL27	SL30	SL40	SL50							
AVX "Insertable"	SL07	SL29	SL59	N/A	N/A	SL65	SL75	N/A							
Width (W)	3.81 (.150)	5.08 (.200)	5.08 (.200)	5.08 (.200)	6.604 (.260)	7.62 (.300)	10.16 (.400)	12.70 (.500)							
Height (H)	3.81 (.150)	5.08 (.200)	5.08 (.200)	5.08 (.200)	6.35 (.250)	7.62 (.300)	10.16 (.400)	12.70 (.500)							
Thickness (T)	2.54 (.100)	3.175 (.125)	3.175 (.125)	3.175 (.125)	4.06 (.160)	3.81 (.150)	3.81 (.150)	5.08 (.200)							
Lead Spacing (L.S.)	2.54 (.100)	2.54 (.100)	5.08 (.200)	6.35 (.250)	7.62 (.300)	5.08 (.200)	5.08 (.200)	10.16 (.400)							
Lead Diameter (L.D.)	.508 (.020)	.508 (.020)	.508 (.020)	.508 (.020)	.508 (.020)	.508 (.020)	.508 (.020)	.635 (.025)							
Cap. in.* Industry Preferred pF	VVDC		VVDC		VVDC		VVDC		VVDC		VVDC		VVDC		
	200	100	50	200	100	50	200	100	50	200	100	50	200	100	50
470	SL.....C471KAB														
1000	SL155C102KAB														
1500	SL.....C152KAB														
2200	SL.....C222KAB														
3300	SL.....C332KAB														
4700	SL.....C472KAB														
6800	SL.....C682KAB														
10,000	SL215C103KAB														
15,000	SL.....C153KAB														
22,000	SL.....C223KAB														
33,000	SL.....C333KAB														
47,000	SL.....C473KAB														
68,000	SL.....C683KAB														
100,000	SL215C104KAB														
150,000	SL.....C154KAB														
220,000	SL215C224KAB														
330,000	SL.....C334KAB														
390,000	SL.....C394KAB														
470,000	SL305C474KAB														
1.0 µF	SL305C105KAB														
2.2 µF	SL405C225KAB														
2.7 µF	SL505C275KAB														
4.7 µF	SL505C475KAB														

For other styles, voltages, tolerances and lead lengths see Part No. Codes or contact factory.

*Other capacitance values available upon special request.

- = Industry preferred values
- = SL20 only
- = Extended range
- = Extended range, SL20 only
- = Extended range with 0.150" thickness maximum

NOTE: Capacitance Ranges available for SL12 same as SL15
SL62 same as SL21
SL64 same as SL30
SL89 same as SL21

SL Series

SkyCap® Radial Conformal Coated Z5U Dielectric

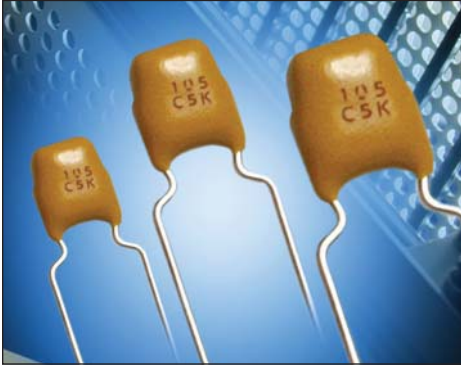

AVX SL Series is a conformally coated radial lead capacitor. We offer NP0, X7R, and Z5U dielectrics standard. Alternative dielectrics are also available upon request. Voltages range from 50V to 500V, with lower voltages available as well.

Check for up-to-date CV Tables at <http://www.avx.com/docs/catalogs/skycap.pdf>

HOW TO ORDER

SL21	5	E	104	M	A	B
AVX Style	Voltage	Temperature Coefficient	Capacitance	Capacitance Tolerance	Failure Rate	Leads
SL15 SL20 SL21 SL22 SL27 SL30 SL40 SL50	5 = 50V 1 = 100V	E = Z5U	First two digits are the significant figures of capacitance. Third digit indicates the additional number of zeros. For example, order 100,000 pF as 104. (For values below 10pF use "R" in place of decimal point, e.g., 1R4 = 1.4pF.)	M = ±20% Z = +80% -20%	A = Not Applicable	B = Tin/Lead

Z5U Dielectric

AVX Style		SL15	SL20	SL21	SL22	SL27	SL30	SL40	SL50		
AVX "Insertable"		SL07	SL29	SL59	N/A	N/A	SL65	SL75	N/A		
Cap. in.* pF	Industry Preferred Values in Blue	WVDC		WVDC		WVDC		WVDC		WVDC	
		100	50	100	50	100	50	100	50	100	50
10,000	SL155E103ZAB										
47,000	SL.....E473ZAB										
100,000	SL215E104ZAB										
150,000	SL.....E154ZAB										
220,000	SL215E224ZAB										
330,000	SL215E334ZAB										
470,000	SL215E474ZAB										
680,000	SL.....E684ZAB										
1.0 µF	SL.....105ZAB										
1.5 µF	SL30E155ZAB										
2.2 µF	SL30E225ZAB										
3.3 µF	SL30E335ZAB										
4.7 µF	SL30E475ZAB										

For other styles, voltages, tolerances and lead lengths see Part No. Codes or contact factory.

*Other capacitance values available upon special request.

- = Industry preferred values
- = SL20 only

AR Series (Automotive)

SkyCap® Radial Conformal Coated C0G (NP0) Dielectric



AVX AR Series is a conformally coated radial leaded capacitor. We offer NP0, X7R, and X8R dielectrics standard. Alternative dielectrics are also available upon request. Voltages range from 50V to 200V.

[Check for up-to-date CV Tables at http://www.avx.com/docs/catalogs/skycap.pdf](http://www.avx.com/docs/catalogs/skycap.pdf)

HOW TO ORDER

AR21	5	A	100	F	4	R
AVX Style	Voltage	Temperature Coefficient	Capacitance	Capacitance Tolerance	Failure Rate	Leads
	5 = 50V 1 = 100V 2 = 200V	A = C0G (NP0)	First two digits are the significant figures of capacitance. Third digit indicates the additional number of zeros. For example, order 100,000 pF as 104. (For values below 10pF use "R" in place of decimal point, e.g., 1R4 = 1.4pF.)	C = ±.25pF D = ±.5pF F = ±1% (>50pF only) G = ±2% (>25pF only) J = ±5% K = ±10%	4 = AEC-Q200	R = RoHS

C0G (NP0) Dielectric

EIA Characteristic Dimensions: Millimeters (Inches)

AVX Style		AR15			AR20			AR21		
AVX "Insertable"		AR07			AR29			AR59		
Cap in pF	Industry Preferred Values in Blue	WVDC			WVDC			WVDC		
		200	100	50	200	100	50	200	100	50
1	AR-----A1R0D4R									
10	AR.....A100K4R									
15	AR-----A150K4R									
22	AR-----A220K4R									
33	AR-----A330K4R									
39	AR-----A390K4R									
47	AR-----A470K4R									
68	AR-----A680K4R									
100	AR.....A101K4R									
150	AR-----A151K4R									
220	AR-----A221K4R									
330	AR-----A331K4R									
390	AR-----A391K4R									
470	AR-----A471K4R									
680	AR-----A681K4R									
1,000	AR.....A102K4R									
1,500	AR-----A152K4R									
2,200	AR-----A222K4R									
3,900	AR-----A392K4R									
4,700	AR.....A472K4R									
6800	AR-----A682K4R									
8200	AR-----A822K4R									

Notes:
 "Insertable" make reference to alternative AVX style using the same range of capacitance available on the matrix.
 For others Styles, voltages, tolerance and lead lengths see Skycap catalog or contact factory.
 Others capacitance values available upon special request.
 Others styles available: AR12, AR14, AR62, AR89.

AR Series (Automotive)

SkyCap® Radial Conformal Coated X7R Dielectric



AVX AR Series is a conformally coated radial leaded capacitor. We offer NP0, X7R, and X8R dielectrics standard. Alternative dielectrics are also available upon request. Voltages range from 50V to 200V.

Check for up-to-date CV Tables at <http://www.avx.com/docs/catalogs/skycap.pdf>

HOW TO ORDER

AR21	5	C	104	M	4	R
AVX Style	Voltage 5 = 50V 1 = 100V	Temperature Coefficient C = X7R	Capacitance First two digits are the significant figures of capacitance. Third digit indicates the additional number of zeros. For example, order 100,000 pF as 104. (For values below 10pF use "R" in place of decimal point, e.g., 1R4 = 1.4pF)	Capacitance Tolerance J = ±5% K = ±10% M = ±20%	Failure Rate 4 = AEC-Q200	Leads R = RoHS

X7R Dielectric

EIA Characteristic Dimensions: Millimeters (Inches)

Cap in pF	AVX Style	AR15	AR20	AR21	AR30	AR40
	AVX "Insertable"	AR07	AR29	AR59	AR65	AR75
Industry Preferred Values in Blue	WVDC	WVDC	WVDC	WVDC	WVDC	WVDC
	100 50	100 50	100 50	100 50	100 50	100 50
470	AR----C471K4R					
1000	AR----C102K4R					
1500	AR----C152K4R					
2200	AR----C222K4R					
3300	AR----C332K4R					
4700	AR----C472K4R					
6800	AR----C682K4R					
10,000	AR----C103K4R					
15,000	AR----C153K4R					
22,000	AR----C223K4R					
33,000	AR----C333K4R					
47,000	AR----C473K4R					
68,000	AR----C683K4R					
100,000	AR----C104K4R					
150,000	AR----C154K4R					
220,000	AR----C224K4R					
330,000	AR----C334K4R					
390,000	AR----C394K4R					
470,000	AR----C474K4R					
680,000	AR----C684K4R					
1.0 uF	AR----C105K4R					
4,700,000	AR----C475K4R					
6,800,000	AR----C685K4R					
10.0 uF	AR----C106K4R					

Notes:
 "Insertable" make reference to alternative AVX style using the same range of capacitance available on the matrix.
 For others Styles, voltages, tolerance and lead lengths see Skycap catalog or contact factory.
 Others capacitance values available upon special request.
 Others styles available: AR12, AR14, AR62, AR89, AR32, AR38.

AR Series (Automotive)

SkyCap® Radial Conformal Coated X8R Dielectric



AVX AR Series is a conformally coated radial leaded capacitor. We offer NP0, X7R, and X8R dielectrics standard. Alternative dielectrics are also available upon request. Voltages range from 50V to 200V.

Check for up-to-date CV Tables at <http://www.avx.com/docs/catalogs/skycap.pdf>

HOW TO ORDER

AR21	5	F	104	M	4	R
↓	↓	↓	↓	↓	↓	↓
AVX Style	Voltage	Temperature Coefficient	Capacitance	Capacitance Tolerance	Failure Rate	Leads
	5 = 50V 1 = 100V 2 = 200V	F = X8R	First two digits are the significant figures of capacitance. Third digit indicates the additional number of zeros. For example, order 100,000 pF as 104. (For values below 10pF use "R" in place of decimal point, e.g., 1R4 = 1.4pF.)	J = ±5% K = ±10% M = ±20%	4 = AEC-Q200	R = RoHS

X8R Dielectric

EIA Characteristic Dimensions: Millimeters (Inches)

AVX Style		AR20			AR21		
AVX "Insertable"		AR29			AR59		
Cap in pF	Industry Preferred Values in Blue	WVDC			WVDC		
		200	100	50	200	100	50
1,000	AR.....F102K4R						
10,000	AR.....F103K4R						
100,000	AR.....F104K4R						
330,000	AR.....F334K4R						

Notes:
 "Insertable" make reference to alternative AVX style using the same range of capacitance available on the matrix.
 For others Styles, voltages, tolerance and lead lengths see Skycap catalog or contact factory.
 Others capacitance values available upon special request.
 Others styles available: AR14, AR62, AR89.

MR Series

Molded Radial MLCC NP0 Dielectric

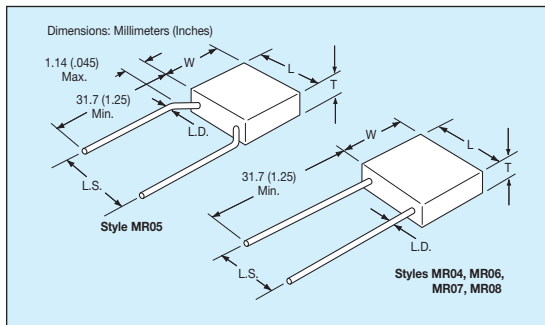

AVX MR series is a molded radial leaded capacitor. We offer NP0, X7R, and Z5U dielectrics. Voltage available are 50, 100, & 200 VDC. AVX also offers military grade molded radials per MIL-PRF-39014, MIL-C-11015, and MIL-PRF-20.

Check for up-to-date CV Tables at <http://www.avx.com/docs/catalogs/rceralam.pdf>

HOW TO ORDER

- MR05**
AVX Style
MR04
MR05
MR06
MR07
MR08
- 1**
Voltage
5 = 50V
1 = 100V
2 = 200V
- A**
Dielectric
A = COG (NP0)
- 561**
Capacitance
First two digits are the significant figures of capacitance. Third digit indicates the additional number of zeros. For example, order 100,000 pF as 104. (For values below 10pF use "R" in place of decimal point, e.g., 1R4 = 1.4pF)
- J**
Capacitance Tolerance
D = ±5pF (>10pF only)
F = ±1% (>50pF only)
G = ±2% (>25pF only)
J = ±5%
K = ±10%
- A**
Failure Rate
A = Not Applicable
- A**
Leads
A = Standard Solderable
T¹ = Trimmed Leads .230" ± .030"

¹ Trimmed lead length for the MR05 style will be measured from the bend in the lead (seating plane).

COG (NP0) Dielectric

Cap. in pF	AVX Style Typical AVX Part Nos.	MR04		MR05		MR06		MR07		MR08	
		WVDC		WVDC		WVDC		WVDC		WVDC	
1.0 to 9.1	MR.....5A1R0DAA MR.....5A9R1DAA										
10 to 15	MR.....5A100KAA MR.....5A120KAA MR.....5A150KAA										
18 to 27	MR.....5A180KAA MR.....5A220KAA MR.....5A270KAA										
33 to 47	MR.....5A330KAA MR.....5A390KAA MR.....5A470KAA										
56 to 82	MR.....5A560KAA MR.....5A680KAA MR.....5A820KAA										
100 to 150	MR.....5A101KAA MR.....5A121KAA MR.....5A151KAA										
180 to 270	MR.....5A181KAA MR.....5A221KAA MR.....5A271KAA										
330 to 470	MR.....5A331KAA MR.....5A391KAA MR.....5A471KAA										
560 to 820	MR.....5A561KAA MR.....5A681KAA MR.....5A821KAA										
1000 to 1500	MR.....5A102KAA MR.....5A122KAA MR.....5A152KAA										
1800 to 2700	MR.....5A182KAA MR.....5A222KAA MR.....5A272KAA										
3300 to 4700	MR.....5A332KAA MR.....5A392KAA MR.....5A472KAA										
5600 to 8200	MR.....5A562KAA MR.....5A682KAA MR.....5A822KAA										
10,000 to 15,000	MR.....5A103KAA MR.....5A123KAA MR.....5A153KAA										
18,000 to 27,000	MR.....5A183KAA MR.....5A223KAA MR.....5A273KAA										
33,000 to 47,000	MR.....5A333KAA MR.....5A393KAA MR.....5A473KAA										
56,000 to 82,000	MR.....5A563KAA MR.....5A683KAA MR.....5A823KAA										
100,000 to 150,000	MR.....5A104KAA MR.....5A124KAA MR.....5A154KAA										

For trimmed leads see "How To Order".
For other tolerances see "How To Order".
For other voltages see "How To Order".
= Industry preferred values

MR Series

Molded Radial MLCC X7R Dielectric

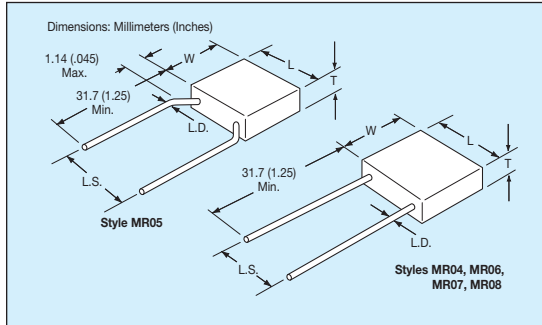

AVX MR series is a molded radial leaded capacitor. We offer NP0, X7R, and Z5U dielectrics. Voltage available are 50, 100, & 200 VDC. AVX also offers military grade molded radials per MIL-PRF-39014, MIL-C-11015, and MIL-PRF-20.

Check for up-to-date CV Tables at <http://www.avx.com/docs/catalogs/rceralam.pdf>

HOW TO ORDER

- MR05**
AVX Style
MR04
MR05
MR06
MR07
MR08
- 1**
Voltage
5 = 50V
1 = 100V
2 = 200V
- C**
Dielectric
C = X7R
- 561**
Capacitance
First two digits are the significant figures of capacitance. Third digit indicates the additional number of zeros. For example, order 100,000 pF as 104. (For values below 10pF use "R" in place of decimal point, e.g., 1R4 = 1.4pF)
- J**
Capacitance Tolerance
J = ±5%
K = ±10%
M = ±20%
- A**
Failure Rate
A = Not Applicable
T = CECC
- A**
Leads
A = Standard Solderable
T' = Trimmed Leads .230" ± .030"

¹ Trimmed lead length for the MR05 style will be measured from the bend in the lead (seating plane).

X7R Dielectric

Cap. in pF	AVX Style Typical AVX Part Nos.	MR04 WVDC	MR05 WVDC	MR06 WVDC	MR07 WVDC	MR08 WVDC
100	MR.....5C101KAA					
120	MR.....5C121KAA					
150	MR.....5C151KAA					
180	MR.....5C181KAA					
220	MR.....5C221KAA					
270	MR.....5C271KAA					
330	MR.....5C331KAA					
390	MR.....5C391KAA					
470	MR.....5C471KAA					
560	MR.....5C561KAA					
680	MR.....5C681KAA					
820	MR.....5C821KAA					
1000	MR.....5C102KAA					
1200	MR.....5C122KAA					
1500	MR.....5C152KAA					
1800	MR.....5C182KAA					
2200	MR.....5C222KAA					
2700	MR.....5C272KAA					
3300	MR.....5C332KAA					
3900	MR.....5C392KAA					
4700	MR.....5C472KAA					
5600	MR.....5C562KAA					
6800	MR.....5C682KAA					
8200	MR.....5C822KAA					
10,000	MR.....5C103KAA					
12,000	MR.....5C123KAA					
15,000	MR.....5C153KAA					
18,000	MR.....5C183KAA					
22,000	MR.....5C223KAA					
27,000	MR.....5C273KAA					
33,000	MR.....5C333KAA					
39,000	MR.....5C393KAA					
47,000	MR.....5C473KAA					
56,000	MR.....5C563KAA					
68,000	MR.....5C683KAA					
82,000	MR.....5C823KAA					
100,000	MR.....5C104KAA					
120,000	MR.....5C124KAA					
150,000	MR.....5C154KAA					
180,000	MR.....5C184KAA					
220,000	MR.....5C224KAA					
270,000	MR.....5C274KAA					
330,000	MR.....5C334KAA					
390,000	MR.....5C394KAA					
470,000	MR.....5C474KAA					
560,000	MR.....5C564KAA					
680,000	MR.....5C684KAA					
820,000	MR.....5C824KAA					
1.0 µF	MR.....5C105KAA					
1.2 µF	MR.....5C125KAA					
1.5 µF	MR.....5C155KAA					
1.8 µF	MR.....5C185KAA					
2.0 µF	MR.....5C205KAA					
2.2 µF	MR.....5C225KAA					
2.7 µF	MR.....5C275KAA					
3.3 µF	MR.....5C335KAA					
3.9 µF	MR.....5C395KAA					
4.7 µF	MR.....5C475KAA					

For trimmed leads see "How To Order".
For other tolerances see "How To Order".
For other voltages see "How To Order".

= Industry preferred values

MR Series

Molded Radial MLCC Z5U Dielectric

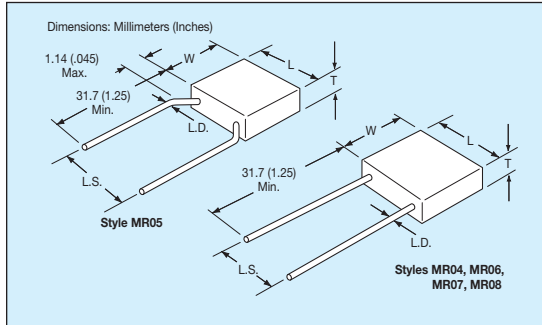

AVX MR series is a molded radial leaded capacitor. We offer NPO, X7R, and Z5U dielectrics. Voltage available are 50, 100, & 200 VDC. AVX also offers military grade molded radials per MIL-PRF-39014, MIL-C-11015, and MIL-PRF-20.

Check for up-to-date CV Tables at <http://www.avx.com/docs/catalogs/rceralam.pdf>

HOW TO ORDER

MR05	1	A	561	Z	A	A
AVX Style	Voltage	Dielectric	Capacitance	Capacitance Tolerance	Failure Rate	Leads
MR04 MR05 MR06 MR07 MR08	5 = 50V 1 = 100V	A = COG (NPO) C = X7R E = Z5U	First two digits are the significant figures of capacitance. Third digit indicates the additional number of zeros. For example, order 100,000 pF as 104. (For values below 10pF use "R" in place of decimal point, e.g., 1R4 = 1.4pF)	M = ±20% Z = +80% -20%	A = Not Applicable	A = Standard Solderable T ¹ = Trimmed Leads .230" ± .030"
						¹ Trimmed lead length for the MR05 style will be measured from the bend in the lead (seating plane).

Z5U Dielectric

Cap. in pF	AVX Style Typical AVX Part Nos.	MR04		MR05		MR06		MR07		MR08	
		100	50	100	50	100	50	100	50	100	50
10,000	MR.....5E103ZAA										
12,000	MR.....5E123ZAA										
15,000	MR.....5E153ZAA										
18,000	MR.....5E183ZAA										
22,000	MR.....5E223ZAA										
27,000	MR.....5E273ZAA										
33,000	MR.....5E333ZAA										
39,000	MR.....5E393ZAA										
47,000	MR.....5E473ZAA										
56,000	MR.....5E563ZAA										
68,000	MR.....5E683ZAA										
82,000	MR.....5E823ZAA										
100,000	MR.....5E104ZAA										
120,000	MR.....5E124ZAA										
150,000	MR.....5E154ZAA										
180,000	MR.....5E184ZAA										
220,000	MR.....5E224ZAA										
270,000	MR.....5E274ZAA										
330,000	MR.....5E334ZAA										
390,000	MR.....5E394ZAA										
470,000	MR.....5E474ZAA										
560,000	MR.....5E564ZAA										
680,000	MR.....5E684ZAA										
820,000	MR.....5E824ZAA										
1.0 µF	MR.....5E105ZAA										
1.2 µF	MR.....5E125ZAA										
1.5 µF	MR.....5E155ZAA										
1.8 µF	MR.....5E185ZAA										
2.2 µF	MR.....5E225ZAA										
2.7 µF	MR.....5E275ZAA										
3.3 µF	MR.....5E335ZAA										
3.9 µF	MR.....5E395ZAA										
4.7 µF	MR.....5E475ZAA										
5.6 µF	MR.....5E565ZAA										
6.8 µF	MR.....5E685ZAA										
8.2 µF	MR.....5E825ZAA										
10.0 µF	MR.....5E106ZAA										

For trimmed leads see "How To Order".
For other tolerances see "How To Order".
For other voltages see "How To Order".

 = Industry preferred values

MD Series

2 Pin DIP

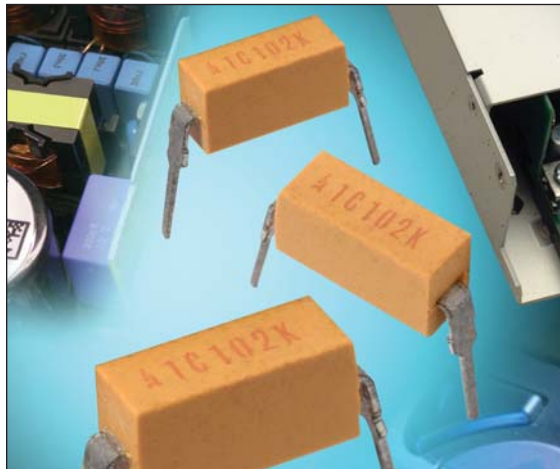

AVX MD series is a Molded 2 Pin DIP capacitor. We offer NP0, X7R, and Z5U dielectrics. Voltages available are 50 and 100Vdc.

Check for up-to-date CV Tables at <http://www.avx.com/docs/catalogs/dipguard.pdf>

HOW TO ORDER

MD01	5	E	104	M	A	B
AVX Style MD01 CKR22* CKS22** MD02 CKR23* CKS23* MD03 CKR24* CKS24**	Voltage 5 = 50V 1 = 100V	Temperature Coefficient A = C0G (NP0) C = X7R E = Z5U	Capacitance First two digits are the significant figures of capacitance. Third digit indicates the additional number of zeros. For example, order 100,000 pF as 104.	Capacitance Tolerance COG (NP0): F = ±1% J = ±5% K = ±10% X7R: J = ±5% K = ±10% M = ±20% Z5U: M = ±20% Z = +80% -20%	Failure Rate A = Not Applicable	Assembly Method A = Hand Assembled B = Automated Assembly

C0G (NP0)

EIA Characteristic		C0G (NP0)	
AVX Style		MD01	
Cap. in pF*	AVX Style	WVDC	
		100	50
10	MD015A100KAB		
15	MD015A150KAB		
22	MD015A220KAB		
33	MD015A330KAB		
47	MD015A470KAB		
68	MD015A680KAB		
100	MD015A101KAB		
150	MD015A151KAB		
220	MD015A221KAB		
330	MD015A331KAB		
470	MD015A471KAB		
680	MD015A681KAB		
1000	MD015A102KAB		
1500	MD015A152KAB		
2200	MD015A222KAB		
3300	MD015A332KAB		
AVX Style		MD02	
Cap. in pF*	AVX Style	WVDC	
		100	50
4700	MD025A472KAB		
6800	MD025A682KAB		
10000	MD025A103KAB		

For other voltages and tolerances see Part No. Codes.

X7R

EIA Characteristic		X7R	
AVX Style		MD01	
Cap. in pF*	AVX Style	WVDC	
		100	50
220	MD015C221KAB		
330	MD015C331KAB		
470	MD015C471KAB		
680	MD015C681KAB		
1000	MD015C102KAB		
1500	MD015C152KAB		
2200	MD015C222KAB		
3300	MD015C332KAB		
4700	MD015C472KAB		
6800	MD015C682KAB		
10,000	MD011C103KAB		
15,000	MD015C153KAB		
22,000	MD015C223KAB		
33,000	MD015C333KAB		
47,000	MD015C473KAB		
68,000	MD015C683KAB		
100,000	MD015C104KAB		
AVX Style		MD02	
Cap. in pF*	AVX Style	WVDC	
		100	50
150,000	MD025C154KAB		
220,000	MD025C224KAB		
AVX Style		MD03	
Cap. in pF*	AVX Style	WVDC	
		100	50
330,000	MD035C334KAA		
470,000	MD035C474KAA		
680,000	MD035C684KAA		
1,000,000	MD035C105KAA		

For other voltages and tolerances see Part No. Codes.

Z5U

EIA Characteristic		Z5U	
AVX Style		MD01	
Cap. in pF*	AVX Style	WVDC	
		100	50
10,000	MD015E103ZAB		
15,000	MD015E153ZAB		
22,000	MD015E223ZAB		
33,000	MD015E333ZAB		
47,000	MD015E473ZAB		
68,000	MD015E683ZAB		
100,000	MD015E104ZAB		
150,000	MD015E154ZAB		
220,000	MD015E224ZAB		
330,000	MD015E334ZAB		
AVX Style		MD02	
Cap. in pF*	AVX Style	WVDC	
		100	50
470,000	MD025E474ZAB		
AVX Style		MD03	
Cap. in pF*	AVX Style	WVDC	
		100	50
680,000	MD035E684ZAA		
1,000,000	MD035E105ZAA		

For other voltages and tolerances see Part No. Codes.

*Other capacitance values available upon special request.

 = Industry preferred values

SA Series

SpinGuard® Axial Conformal Coated NP0 Dielectric

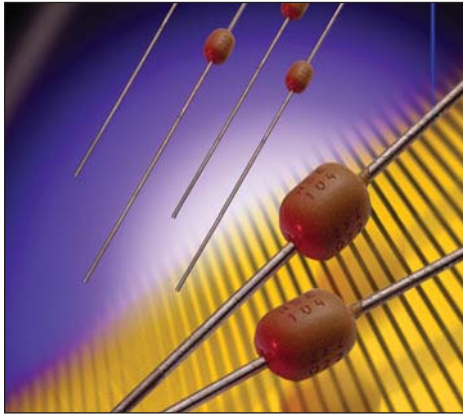

AVX SA series is a conformally coated axial leaded capacitor. We offer NP0, X7R, X5R, and Z5U dielectrics. Voltages available are 10, 50, 100, and 200Vdc. Lower voltages available upon request.

Check for up-to-date CV Tables at <http://www.avx.com/docs/catalogs/spingrd.pdf>

HOW TO ORDER

SA10	5	A	104	F	A	R
Conformal Axial Size	Voltage	Dielectric	Capacitance	Capacitance Tolerance	Failure Rate	Leads
SA05 SA10 SA11 SA20 SA30 SA40	5 = 50V 1 = 100V 2 = 200V	A = COG (NP0)	First two digits are the significant figures of capacitance. Third digit indicates the additional number of zeros. For example, order 100,000 pF as 104. (For values below 10pF use "R" in place of decimal point, e.g., 1R4 = 1.4pF)	C = ±.25pF D = ±.5pF F = ±1% G = ±2% J = ±5% K = ±10%	A = Not Applicable	Standard (Solderable) R = RoHS Compliant A = Standard Solderable

NP0 Dielectric

Cap. in pF	AVX Style Typical AVX Part Nos.	SA05		SA10			SA11		SA20		SA30		SA40	
		WVDC 200	WVDC 100	WVDC 200	WVDC 100	WVDC 50	WVDC 100	WVDC 50	WVDC 100	WVDC 50	WVDC 100	WVDC 50	WVDC 100	WVDC 50
1.0* + 9.1*	SA102A1R0DAR + SA102A9R1DAR													
10 12 15	SA102A100JAR SA102A120JAR SA102A150JAR													
18 22 27	SA102A180JAR SA102A220JAR SA102A270JAR													
33 39 47	SA102A330JAR SA102A390JAR SA102A470JAR													
56 68 82	SA102A560JAR SA102A680JAR SA102A820JAR													
100 120 150	SA102A101JAR SA102A121JAR SA101A151JAR													
180 220 270	SA101A181JAR SA101A221JAR SA101A271JAR													
330 390 470	SA101A331JAR SA101A391JAR SA101A471JAR													
560 680 820	SA101A561JAR SA101A681JAR SA101A821JAR													
1000 1200 1500	SA105A102JAR SA201A122JAR SA201A152JAR													
1800 2200 2700	SA205A182JAR SA301A222JAR SA301A272JAR													
3300 3900 4700	SA301A332JAR SA301A392JAR SA305A472JAR													
5600 6800 8200	SA401A562JAR SA401A682JAR SA405A822JAR													
10,000 12,000	SA405A103JAR SA405A123JAR													

For other tolerances see Part No. Codes
For other voltages see Part No. Codes
AVX Style

 = Industry preferred values

**"C&D" Tolerance Only

SA Series

SpinGuard® Axial Conformal Coated X7R Dielectric

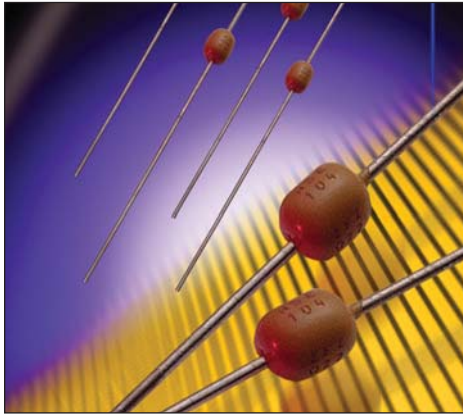

AVX SA series is a conformally coated axial leaded capacitor. We offer NP0, X7R, X5R, and Z5U dielectrics. Voltages available are 10, 50, 100, and 200Vdc. Lower voltages available upon request.

Check for up-to-date CV Tables at <http://www.avx.com/docs/catalogs/spingrd.pdf>

HOW TO ORDER

SA10	5	C	104	K	A	R
↓	↓	↓	↓	↓	↓	↓
Conformal Axial Size	Voltage	Dielectric	Capacitance	Capacitance Tolerance	Failure Rate	Leads
SA05 SA10 SA11 SA20 SA30 SA40	5 = 50V 1 = 100V 2 = 200V	C = X7R	First two digits are the significant figures of capacitance. Third digit indicates the additional number of zeros. For example, order 100,000 pF as 104. (For values below 10pF use "R" in place of decimal point, e.g., 1R4 = 1.4pF)	J = ±5% K = ±10% M = ±20%	A = Not Applicable	Standard (Solderable) R = RoHS Compliant A = Standard Solderable

X7R Dielectric

Cap. in pF	AVX Style Typical AVX Part Nos.	SA05		SA10		SA11		SA20		SA30		SA40	
		200	100 50	200	100 50	100	50	100	50	100	50	100	50
220	SA102C221KAR												
270	SA102C271KAR												
330	SA102C331KAR												
390	SA102C391KAR												
470	SA102C471KAR												
560	SA101C561KAR												
680	SA101C681KAR												
820	SA101C821KAR												
1000	SA101C102KAR												
1200	SA101C122KAR												
1500	SA101C152KAR												
1800	SA101C182KAR												
2200	SA101C222KAR												
2700	SA101C272KAR												
3300	SA101C332KAR												
3900	SA101C392KAR												
4700	SA101C472KAR												
5600	SA101C562KAR												
6800	SA101C682KAR												
8200	SA105C822KAR												
10,000	SA105C103KAR												
12,000	SA105C123KAR												
15,000	SA105C153KAR												
18,000	SA105C183KAR												
22,000	SA105C223KAR												
27,000	SA105C273KAR												
33,000	SA105C333KAR												
39,000	SA105C393KAR												
47,000	SA105C473KAR												
56,000	SA115C563KAR												
68,000	SA115C683KAR												
82,000	SA115C823KAR												
100,000	SA115C104KAR												
120,000	SA305C124KAR												
150,000	SA305C154KAR												
180,000	SA305C184KAR												
220,000	SA305C224KAR												
270,000	SA305C274KAR												
330,000	SA305C334KAR												
470,000	SA405C474KAR												
1,000,000	SA305C105KAR												

For other tolerances see Part No. Codes
For other voltages see Part No. Codes
AVX Style

 = Industry preferred values

SA Series

SpinGuard® Axial Conformal Coated X5R Dielectric

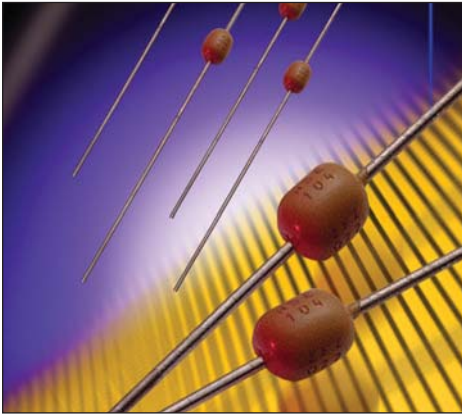

AVX SA series is a conformally coated axial leaded capacitor. We offer NP0, X7R, X5R, and Z5U dielectrics. Voltages available are 10, 50, 100, and 200Vdc. Lower voltages available upon request.

Check for up-to-date CV Tables at <http://www.avx.com/docs/catalogs/spingrd.pdf>

HOW TO ORDER

SA10	5	D	104	K	A	R
Conformal Axial Size SA10	Voltage Z = 10V	Dielectric D = X5R	Capacitance First two digits are the significant figures of capacitance. Third digit indicates the additional number of zeros. For example, order 100,000 pF as 104. (For values below 10pF use "R" in place of decimal point, e.g., 1R4 = 1.4pF)	Capacitance Tolerance K = ±10% M = ±20%	Failure Rate A = Not Applicable	Leads Standard (Solderable) R = RoHS Compliant A = Standard Solderable

Dimensions: Millimeters (Inches)



AVX Style		SA10
Length (L)		4.32 (.170")
Diameter (D)		2.54 (.100")
Lead Diameter		.445 (.0175")
Lead Length		25.4 (1.00")
Cap. in μ F	Typical AVX Part Nos.	WVDC
1.8	SA10ZD185KAR	10
2.7	SA10ZD275KAR	
3.3	SA10ZD335KAR	
4.7	SA10ZD475KAR	

For other tolerances see Part No. Codes
 For other voltages see Part No. Codes
 AVX Style

 = Industry preferred values

SA Series

SpinGuard® Axial Conformal Coated Z5U Dielectric

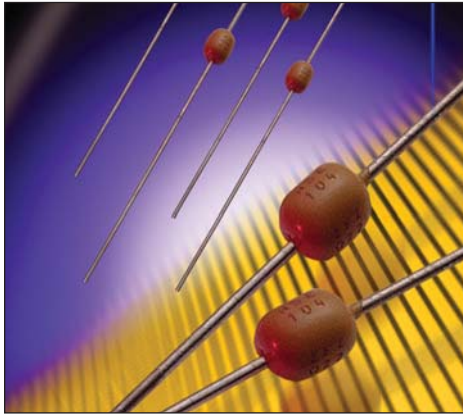

AVX SA series is a conformally coated axial leaded capacitor. We offer NP0, X7R, X5R, and Z5U dielectrics. Voltages available are 10, 50, 100, and 200Vdc. Lower voltages available upon request.

Check for up-to-date CV Tables at <http://www.avx.com/docs/catalogs/spingrd.pdf>

HOW TO ORDER

SA10	5	E	104	Z	A	R
Conformal Axial Size	Voltage	Dielectric	Capacitance	Capacitance Tolerance	Failure Rate	Leads
SA05 SA10 SA11 SA20 SA30 SA40	5 = 50V 1 = 100V	E = Z5U	First two digits are the significant figures of capacitance. Third digit indicates the additional number of zeros. For example, order 100,000 pF as 104. (For values below 10pF use "R" in place of decimal point, e.g., 1R4 = 1.4pF.)	M = ±20% Z = +80% -20%	A = Not Applicable	Standard (Solderable) R = RoHS Compliant A = Standard Solderable

Z5U Dielectric

Cap. in pF	AVX Style Typical AVX Part Nos.	SA05		SA10		SA11		SA20		SA30		SA40	
		WVDC 50		100	50	100	50	100	50	100	50	100	50
10,000 15,000 22,000	SA105E103ZAR SA105E153ZAR SA105E223ZAR												
33,000 47,000 68,000	SA105E333ZAR SA105E473ZAR SA105E683ZAR												
*100,000 150,000 220,000	SA105E104ZAR SA105E154ZAR SA105E224ZAR												
330,000 470,000 680,000	SA115E334ZAR SA305E474ZAR SA305E684ZAR												
820,000 1,000,000	SA305E824ZAR SA305E105ZAR												

For other tolerances see Part No. Codes
For other voltages see Part No. Codes
AVX Style

= Industry preferred values

*Preferred Industry Decoupling Capacitor — Insertable on .300" centers.

SA105E104ZAA

MA Series

Molded Axial NP0 Dielectric

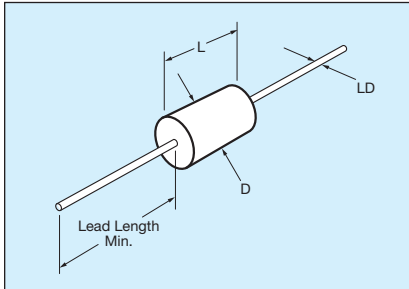

AVX MA series is a molded axial leaded capacitor. We offer NP0, X7R, and Z5U dielectrics. Voltages available are 50V, 100V, and 200Vdc. AVX also offers military grade molded axials per MIL-C-11015, MIL-PRF-39014, and MIL-PRF-20.

Check for up-to-date CV Tables at <http://www.avx.com/docs/catalogs/aceralam.pdf>

HOW TO ORDER

MA10

Molded Axial Size

- MA10
- MA20
- MA30
- MA40
- MA50
- MA60

5

Voltage
5 = 50V
1 = 100V
2 = 200V

A

Dielectric
A = COG (NP0)

104

Capacitance

First two digits are the significant figures of capacitance. Third digit indicates the additional number of zeros. For example, order 100,000 pF as 104. (For values below 10pF use "R" in place of decimal point, e.g., 1R4 = 1.4pF.)

J

Capacitance Tolerance

- F = ±1%
- J = ±5%
- K = ±10%
- M = ±20%
- D = ±5.pF <10pF only

A

Failure Rate
A = Not Applicable

A

Leads
A = Standard

‡ C tolerance available COG (NP0) from 1.0 to 9.1 pF only. Minimum tolerance for values 10 pF - 100 pF is D or F whichever is greater.

NP0 Dielectric

Cap. in pF	AVX Style Typical AVX Part Nos.	MA10			MA20			MA30			MA40			MA50			MA60		
		WVDC	WVDC	WVDC	WVDC	WVDC	WVDC	WVDC	WVDC	WVDC	WVDC	WVDC	WVDC	WVDC	WVDC	WVDC	WVDC		
1.0 to 9.1	MA...5A1R0DAA MA...5A9R1DAA																		
10 to 15	MA...5A100KAA MA...5A120KAA MA...5A150KAA																		
18 to 27	MA...5A180KAA MA...5A220KAA MA...5A270KAA																		
33 to 47	MA...5A330KAA MA...5A390KAA MA...5A470KAA																		
56 to 82	MA...5A560KAA MA...5A680KAA MA...5A820KAA																		
100 to 150	MA...5A101KAA MA...5A121KAA MA...5A151KAA																		
180 to 270	MA...5A181KAA MA...5A221KAA MA...5A271KAA																		
330 to 470	MA...5A331KAA MA...5A391KAA MA...5A471KAA																		
560 to 820	MA...5A561KAA MA...5A681KAA MA...5A821KAA																		
1000 to 1500	MA...5A102KAA MA...5A122KAA MA...5A152KAA																		
1800 to 2700	MA...5A182KAA MA...5A222KAA MA...5A272KAA																		
3300 to 4700	MA...5A332KAA MA...5A392KAA MA...5A472KAA																		
5600 to 8200	MA...5A562KAA MA...5A682KAA MA...5A822KAA																		
10,000 to 15,000	MA...5A103KAA MA...5A123KAA MA...5A153KAA																		
18,000 to 27,000	MA...5A183KAA MA...5A223KAA MA...5A273KAA																		
33,000 to 47,000	MA...5A333KAA MA...5A393KAA MA...5A473KAA																		
56,000 to 82,000	MA...5A563KAA MA...5A683KAA MA...5A823KAA																		
100,000 to 150,000	MA...5A104KAA MA...5A124KAA MA...5A154KAA																		

For other tolerances see Part No. Codes
For other voltages see Part No. Codes.
AVX Style

MA Series

Molded Axial X7R Dielectric

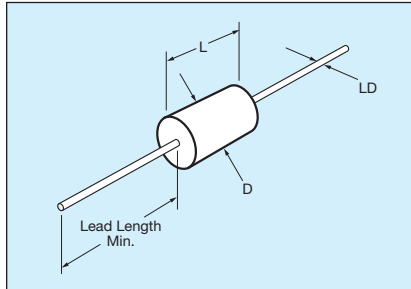

AVX MA series is a molded axial leaded capacitor. We offer NP0, X7R, and Z5U dielectrics. Voltages available are 50V, 100V, and 200Vdc. AVX also offers military grade molded axials per MIL-C-11015, MIL-PRF-39014, and MIL-PRF-20.

Check for up-to-date CV Tables at <http://www.avx.com/docs/catalogs/aceralam.pdf>

HOW TO ORDER

MA10

Molded Axial Size

- MA10
- MA20
- MA30
- MA40
- MA50
- MA60

5

Voltage

- 5 = 50V
- 1 = 100V
- 2 = 200V

C

Dielectric

C = X7R

104

Capacitance

First two digits are the significant figures of capacitance. Third digit indicates the additional number of zeros. For example, order 100,000 pF as 104. (For values below 10pF use "R" in place of decimal point, e.g., 1R4 = 1.4pF.)

J

Capacitance Tolerance

- J = ±5%
- K = ±10%
- M = ±20%

A

Failure Rate

A = Not Applicable

A

Leads

A = Standard

‡ C tolerance available C0G (NP0) from 1.0 to 9.1 pF only. Minimum tolerance for values 10 pF - 100 pF is D or F whichever is greater.

X7R Dielectric

Cap. in pF	AVX Style Typical AVX Part Nos.	MA10		MA20		MA30		MA40		MA50		MA60	
		WVDC	50	WVDC	50	WVDC	50	WVDC	50	WVDC	50	WVDC	50
220	MA...5C221KAA												
270	MA...5C271KAA												
330	MA...5C331KAA												
390	MA...5C391KAA												
470	MA...5C471KAA												
560	MA...5C561KAA												
680	MA...5C681KAA												
820	MA...5C821KAA												
1000	MA...5C102KAA												
1200	MA...5C122KAA												
1500	MA...5C152KAA												
1800	MA...5C182KAA												
2200	MA...5C222KAA												
2700	MA...5C272KAA												
3300	MA...5C332KAA												
3900	MA...5C392KAA												
4700	MA...5C472KAA												
5600	MA...5C562KAA												
6800	MA...5C682KAA												
8200	MA...5C822KAA												
10,000	MA...5C103KAA												
12,000	MA...5C123KAA												
15,000	MA...5C153KAA												
18,000	MA...5C183KAA												
22,000	MA...5C223KAA												
27,000	MA...5C273KAA												
33,000	MA...5C333KAA												
39,000	MA...5C393KAA												
47,000	MA...5C473KAA												
56,000	MA...5C563KAA												
68,000	MA...5C683KAA												
82,000	MA...5C823KAA												
100,000	MA...5C104KAA												
120,000	MA...5C124KAA												
150,000	MA...5C154KAA												
180,000	MA...5C184KAA												
220,000	MA...5C224KAA												
270,000	MA...5C274KAA												
330,000	MA...5C334KAA												
390,000	MA...5C394KAA												
470,000	MA...5C474KAA												
560,000	MA...5C564KAA												
680,000	MA...5C684KAA												
820,000	MA...5C824KAA												
1.0 µF	MA...5C105KAA												
1.2 µF	MA...5C125KAA												
1.5 µF	MA...5C155KAA												
1.8 µF	MA...5C185KAA												
2.2 µF	MA...5C225KAA												
2.7 µF	MA...5C275KAA												
3.3 µF	MA...5C335KAA												
3.9 µF	MA...5C395KAA												

For other tolerances see Part No. Codes
For other voltages see Part No. Codes.
AVX Style

MA Series

Molded Axial Z5U Dielectric

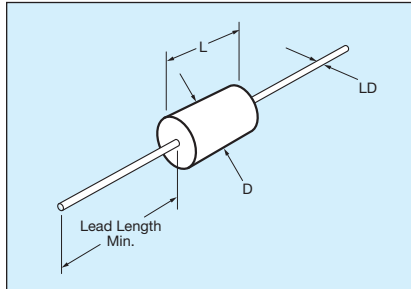

AVX MA series is a molded axial leaded capacitor. We offer NP0, X7R, and Z5U dielectrics. Voltages available are 50V, 100V, and 200Vdc. AVX also offers military grade molded axials per MIL-C-11015, MIL-PRF-39014, and MIL-PRF-20.

Check for up-to-date CV Tables at <http://www.avx.com/docs/catalogs/aceralam.pdf>

HOW TO ORDER

MA10

Molded Axial Size

- MA10
- MA20
- MA30
- MA40
- MA50
- MA60

5

Voltage

- 5 = 50V
- 1 = 100V
- 2 = 200V

E

Dielectric

E = Z5U

104

Capacitance

First two digits are the significant figures of capacitance. Third digit indicates the additional number of zeros. For example, order 100,000 pF as 104. (For values below 10pF use "R" in place of decimal point, e.g., 1R4 = 1.4pF.)

Z

Capacitance Tolerance

- M = ±20%
- Z = +80% -20%

A

Failure Rate

A = Not Applicable

A

Leads

A = Standard

‡ C tolerance available C0G (NP0) from 1.0 to 9.1 pF only. Minimum tolerance for values 10 pF - 100 pF is D or F whichever is greater.

Z5U Dielectric

Cap. in pF	AVX Style Typical AVX Part Nos.	MA10		MA20		MA30		MA40		MA50		MA60	
		WVDC	50	WVDC	50	WVDC	50	WVDC	50	WVDC	50	WVDC	50
1000	MA...5E102ZAA												
1200	MA...5E122ZAA												
1500	MA...5E152ZAA												
1800	MA...5E182ZAA												
2200	MA...5E222ZAA												
2700	MA...5E272ZAA												
3300	MA...5E332ZAA												
3900	MA...5E392ZAA												
4700	MA...5E472ZAA												
5600	MA...5E562ZAA												
6800	MA...5E682ZAA												
8200	MA...5E822ZAA												
10,000	MA...5E103ZAA												
12,000	MA...5E123ZAA												
15,000	MA...5E153ZAA												
18,000	MA...5E183ZAA												
22,000	MA...5E223ZAA												
27,000	MA...5E273ZAA												
33,000	MA...5E333ZAA												
39,000	MA...5E393ZAA												
47,000	MA...5E473ZAA												
56,000	MA...5E563ZAA												
68,000	MA...5E683ZAA												
82,000	MA...5E823ZAA												
100,000	MA...5E104ZAA												
120,000	MA...5E124ZAA												
150,000	MA...5E154ZAA												
180,000	MA...5E184ZAA												
220,000	MA...5E224ZAA												
270,000	MA...5E274ZAA												
330,000	MA...5E334ZAA												
390,000	MA...5E394ZAA												
470,000	MA...5E474ZAA												
560,000	MA...5E564ZAA												
680,000	MA...5E684ZAA												
820,000	MA...5E824ZAA												
1.0 µF	MA...5E105ZAA												
1.2 µF	MA...5E125ZAA												
1.5 µF	MA...5E155ZAA												
1.8 µF	MA...5E185ZAA												
2.2 µF	MA...5E225ZAA												
2.7 µF	MA...5E275ZAA												
3.3 µF	MA...5E335ZAA												
3.9 µF	MA...5E395ZAA												
4.7 µF	MA...5E475ZAA												
5.6 µF	MA...5E565ZAA												
6.8 µF	MA...5E685ZAA												
8.2 µF	MA...5E825ZAA												

For other tolerances see Part No. Codes
For other voltages see Part No. Codes.
AVX Style

Leaded High Voltage MLCC

SV Series Radial Capacitors – C0G Dielectric

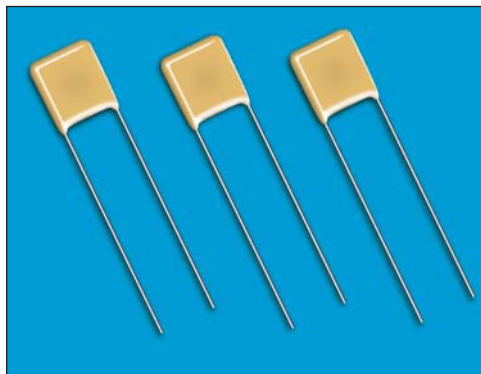

High value, low leakage and small size are difficult parameters to obtain in capacitors for high voltage systems. AVX special high voltage MLC radial leaded capacitors meet these performance characteristics. The added advantage of these capacitors lies in special internal design minimizing the electric field stresses within the MLC. These special design criteria result in significant reduction of partial discharge activity within the dielectric and having, therefore, a major impact on long-term reliability of the product. The SV high voltage radial capacitors are conformally coated with high insulation resistance, high dielectric strength epoxy eliminating the possibility of arc flashover.

The SV high voltage radial MLC designs exhibit low ESRs at high frequency. The same criteria governing the high voltage design carries the added benefits of extremely low ESR in relatively low capacitance and small packages. These capacitors are designed and are ideally suited for applications such as snubbers in high frequency power converters, resonators in SMPS, and high voltage coupling/DC blocking.

Check for up-to-date CV Tables at <http://www.avx.com/docs/catalogs/sv.pdf>

HOW TO ORDER

SV01

A

A

102

K

A

A

AVX Style

Voltage
 C = 600V/630V
 A = 1000V
 S = 1500V
 G = 2000V
 W = 2500V
 H = 3000V
 J = 4000V
 K = 5000V

Temperature Coefficient
 COG = A

Capacitance Code
 (2 significant digits + no. of zeros)
 Examples:
 10 pF = 100
 100 pF = 101
 1,000 pF = 102
 22,000 pF = 223
 220,000 pF = 224
 1 μF = 105

Capacitance Tolerance
 J = ±5%
 K = ±10%
 M = ±20%

Test Level
 A = Standard
 B = Hi-Rel*

Leads
 A = Tin/Lead
 R = RoHS Compliant

Packaging
 (See Note 1)

Note 1: No suffix signifies bulk packaging which is AVX standard packaging. Use suffix "TR1" if tape and reel is required. Parts are reel packaged per EIA-468.

*Hi-Rel screening consists of 100% Group A, Subgroup 1 per MIL-PRF-49467. (Except partial discharge testing is not performed and DWV is at 120% rated voltage).

COG								
Style	600/630V min./max.	1000V min./max.	1500V min./max.	2000V min./max.	2500V min./max.	3000V min./max.	4000V min./max.	5000V min./max.
SV01	100 pF / 1500 pF	100 pF / 1000 pF	10 pF / 330 pF	10 pF / 220 pF	10 pF / 120 pF	10 pF / 82 pF	—	—
SV02/SV52	100 pF / 6800 pF	100 pF / 4700 pF	100 pF / 1500 pF	10 pF / 1000 pF	10 pF / 680 pF	10 pF / 560 pF	10 pF / 150 pF	10 pF / 100 pF
SV03/SV53	100 pF / 0.012 μF	100 pF / 8200 pF	100 pF / 2700 pF	100 pF / 1800 pF	10 pF / 1000 pF	10 pF / 680 pF	10 pF / 390 pF	10 pF / 220 pF
SV04/SV54	100 pF / 3900 pF	100 pF / 2700 pF	10 pF / 820 pF	10 pF / 560 pF	10 pF / 270 pF	10 pF / 180 pF	10 pF / 100 pF	10 pF / 68 pF
SV05/SV55	1000 pF / 0.027 μF	1000 pF / 0.018 μF	100 pF / 6800 pF	100 pF / 4700 pF	100 pF / 2700 pF	100 pF / 1500 pF	10 pF / 1000 pF	10 pF / 560 pF
SV06/SV56	100 pF / 0.012 μF	100 pF / 0.010 μF	100 pF / 3300 pF	100 pF / 2200 pF	10 pF / 1200 pF	10 pF / 820 pF	10 pF / 470 pF	10 pF / 390 pF
SV07/SV57	1000 pF / 0.056 μF	1000 pF / 0.033 μF	1000 pF / 0.015 μF	100 pF / 0.010 μF	100 pF / 5600 pF	100 pF / 3900 pF	100 pF / 2200 pF	10 pF / 1200 pF
SV08/SV58	1000 pF / 0.082 μF	1000 pF / 0.047 μF	1000 pF / 0.022 μF	1000 pF / 0.015 μF	100 pF / 0.010 μF	100 pF / 6800 pF	100 pF / 3300 pF	100 pF / 2200 pF
SV09/SV59	1000 pF / 0.150 μF	1000 pF / 0.082 μF	1000 pF / 0.039 μF	1000 pF / 0.022 μF	1000 pF / 0.015 μF	100 pF / 8200 pF	100 pF / 4700 pF	100 pF / 3300 pF
SV10	1000 pF / 0.100 μF	1000 pF / 0.056 μF	1000 pF / 0.022 μF	1000 pF / 0.012 μF	100 pF / 8200 pF	100 pF / 5600 pF	100 pF / 3300 pF	100 pF / 2200 pF
SV11	1000 pF / 0.150 μF	1000 pF / 0.082 μF	1000 pF / 0.039 μF	1000 pF / 0.022 μF	1000 pF / 0.015 μF	100 pF / 8200 pF	100 pF / 4700 pF	100 pF / 3300 pF
SV12	0.01 μF / 0.220 μF	0.01 μF / 0.15 μF	1000 pF / 0.056 μF	1000 pF / 0.033 μF	1000 pF / 0.022 μF	1000 pF / 0.015 μF	100 pF / 8200 pF	100 pF / 5600 pF
SV13/SV63	100 pF / 0.018 μF	100 pF / 0.012 μF	100 pF / 4700 pF	100 pF / 2700 pF	100 pF / 1800 pF	100 pF / 1000 pF	10 pF / 470 pF	10 pF / 390 pF
SV14/SV64	1000 pF / 0.039 μF	1000 pF / 0.022 μF	100 pF / 8200 pF	100 pF / 5600 pF	100 pF / 3300 pF	100 pF / 1800 pF	10 pF / 820 pF	10 pF / 680 pF
SV15/SV65	1000 pF / 0.056 μF	1000 pF / 0.033 μF	1000 pF / 0.015 μF	100 pF / 0.01 μF	100 pF / 5600 pF	100 pF / 2700 pF	100 pF / 1800 pF	100 pF / 1200 pF
SV16/SV66	1000 pF / 0.120 μF	1000 pF / 0.082 μF	1000 pF / 0.039 μF	1000 pF / 0.022 μF	1000 pF / 0.015 μF	100 pF / 8200 pF	100 pF / 4700 pF	100 pF / 3300 pF
SV17/SV67	1000 pF / 0.150 μF	1000 pF / 0.10 μF	1000 pF / 0.056 μF	1000 pF / 0.039 μF	1000 pF / 0.022 μF	1000 pF / 0.012 μF	100 pF / 6800 pF	100 pF / 4700 pF

Note: Contact factory for other voltage ratings or values.

Leaded High Voltage MLCC

SV Series Radial Capacitors – X7R Dielectric

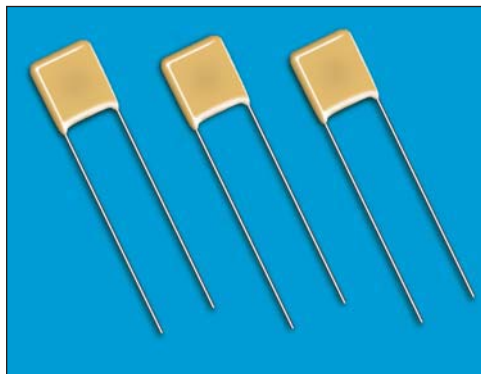

High value, low leakage and small size are difficult parameters to obtain in capacitors for high voltage systems. AVX special high voltage MLC radial leaded capacitors meet these performance characteristics. The added advantage of these capacitors lies in special internal design minimizing the electric field stresses within the MLC. These special design criteria result in significant reduction of partial discharge activity within the dielectric and having, therefore, a major impact on long-term reliability of the product. The SV high voltage radial capacitors are conformally coated with high insulation resistance, high dielectric strength epoxy eliminating the possibility of arc flashover.

The SV high voltage radial MLC designs exhibit low ESRs at high frequency. The same criteria governing the high voltage design carries the added benefits of extremely low ESR in relatively low capacitance and small packages. These capacitors are designed and are ideally suited for applications such as snubbers in high frequency power converters, resonators in SMPS, and high voltage coupling/DC blocking.

Check for up-to-date CV Tables at <http://www.avx.com/docs/catalogs/sv.pdf>

HOW TO ORDER

SV01

A

A

102

K

A

A

AVX Style

Voltage
A = 1000V
S = 1500V
G = 2000V
W = 2500V
H = 3000V
J = 4000V
K = 5000V

Temperature Coefficient
X7R = C

Capacitance Code
(2 significant digits + no. of zeros)
Examples:
10 pF = 100
100 pF = 101
1,000 pF = 102
22,000 pF = 223
220,000 pF = 224
1 μF = 105

Capacitance Tolerance
K = ±10%
M = ±20%
Z = +80
-20%

Test Level
A = Standard
B = Hi-Rel*

Leads
A = Tin/Lead
R = RoHS Compliant

Packaging
(See Note 1)

Note 1: No suffix signifies bulk packaging which is AVX standard packaging. Use suffix "TR1" if tape and reel is required. Parts are reel packaged per EIA-468.

Note: Capacitors with X7R dielectrics are not intended for applications across AC supply mains or AC line filtering with polarity reversal. Contact plant for recommendations.

*Hi-Rel screening consists of 100% Group A, Subgroup 1 per MIL-PRF-49467. (Except partial discharge testing is not performed and DWV is at 120% rated voltage).

X7R								
Style	600/630V min./max.	1000V min./max.	1500V min./max.	2000V min./max.	2500V min./max.	3000V min./max.	4000V min./max.	5000V min./max.
SV01	1000 pF / 0.018 μF	1000 pF / 0.012 μF	100 pF / 5600 pF	100 pF / 3900 pF	—	—	—	—
SV02/SV52	1000 pF / 0.082 μF	1000 pF / 0.047 μF	1000 pF / 0.015 μF	100 pF / 6800 pF	100 pF / 3900 pF	100 pF / 2700 pF	—	—
SV03/SV53	1000 pF / 0.180 μF	1000 pF / 0.082 μF	1000 pF / 0.018 μF	1000 pF / 0.01 μF	100 pF / 6800 pF	100 pF / 4700 pF	100 pF / 1800 pF	—
SV04/SV54	1000 pF / 0.056 μF	1000 pF / 0.033 μF	100 pF / 6800 pF	100 pF / 3900 pF	100 pF / 2200 pF	100 pF / 1800 pF	100 pF / 820 pF	—
SV05/SV55	0.01 μF / 0.470 μF	0.01 μF / 0.22 μF	1000 pF / 0.056 μF	1000 pF / 0.027 μF	1000 pF / 0.018 μF	1000 pF / 0.012 μF	100 pF / 4700 pF	—
SV06/SV56	0.01 μF / 0.180 μF	0.01 μF / 0.10 μF	1000 pF / 0.033 μF	1000 pF / 0.012 μF	100 pF / 8200 pF	100 pF / 6800 pF	100 pF / 2700 pF	100 pF / 1200 pF
SV07/SV57	0.01 μF / 0.820 μF	0.01 μF / 0.39 μF	0.01 μF / 0.10 μF	1000 pF / 0.047 μF	1000 pF / 0.033 μF	1000 pF / 0.027 μF	1000 pF / 0.01 μF	100 pF / 6800 pF
SV08/SV58	0.01 μF / 1.20 μF	0.01 μF / 0.68 μF	0.01 μF / 0.18 μF	1000 pF / 0.082 μF	1000 pF / 0.068 μF	1000 pF / 0.047 μF	1000 pF / 0.018 μF	1000 pF / 0.012 μF
SV09/SV59	0.10 μF / 1.80 μF	0.10 μF / 1.00 μF	0.01 μF / 0.27 μF	0.01 μF / 0.12 μF	0.01 μF / 0.10 μF	1000 pF / 0.068 μF	1000 pF / 0.027 μF	1000 pF / 0.018 μF
SV10	0.01 μF / 1.50 μF	0.01 μF / 0.82 μF	0.01 μF / 0.22 μF	0.01 μF / 0.10 μF	1000 pF / 0.082 μF	1000 pF / 0.056 μF	1000 pF / 0.022 μF	1000 pF / 0.022 μF
SV11	0.10 μF / 2.20 μF	0.10 μF / 1.2 μF	0.01 μF / 0.39 μF	0.01 μF / 0.18 μF	0.01 μF / 0.15 μF	0.01 μF / 0.10 μF	1000 pF / 0.039 μF	1000 pF / 0.027 μF
SV12	0.10 μF / 3.90 μF	0.10 μF / 2.20 μF	0.01 μF / 0.56 μF	0.01 μF / 0.27 μF	0.01 μF / 0.22 μF	0.01 μF / 0.15 μF	1000 pF / 0.056 μF	1000 pF / 0.033 μF
SV13/SV63	0.01 μF / 0.270 μF	0.01 μF / 0.10 μF	1000 pF / 0.033 μF	1000 pF / 0.012 μF	1000 pF / 0.01 μF	100 pF / 6800 pF	100 pF / 2700 pF	—
SV14/SV64	0.01 μF / 0.470 μF	0.01 μF / 0.18 μF	1000 pF / 0.068 μF	1000 pF / 0.022 μF	1000 pF / 0.018 μF	1000 pF / 0.015 μF	100 pF / 5600 pF	—
SV15/SV65	0.01 μF / 0.680 μF	0.01 μF / 0.33 μF	0.01 μF / 0.10 μF	1000 pF / 0.033 μF	1000 pF / 0.027 μF	1000 pF / 0.022 μF	1000 pF / 8200 pF	100 pF / 4700 pF
SV16/SV66	0.01 μF / 1.80 μF	0.01 μF / 1.0 μF	0.01 μF / 0.27 μF	0.01 μF / 0.12 μF	0.01 μF / 0.10 μF	1000 pF / 0.068 μF	1000 pF / 0.027 μF	1000 pF / 0.018 μF
SV17/SV67	0.01 μF / 2.20 μF	0.01 μF / 1.2 μF	0.01 μF / 0.39 μF	0.01 μF / 0.15 μF	0.01 μF / 0.12 μF	1000 pF / 0.082 μF	1000 pF / 0.039 μF	1000 pF / 0.027 μF

Note: Contact factory for other voltage ratings or values.

TAP Series

Dipped Radial Tantalum Capacitors

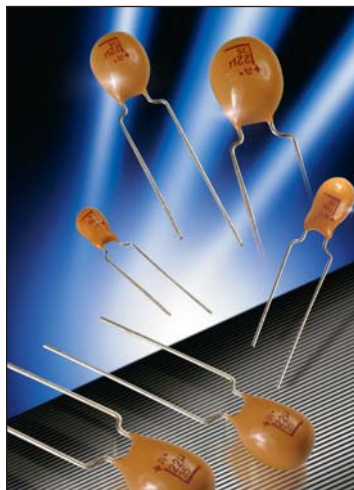

TAP is a professional grade device manufactured with a flame retardant coating and featuring low leakage current and impedance, very small physical sizes and exceptional temperature stability. It is designed and conditioned to operate to +125°C and is available loose or taped and reeled for auto insertion. The 15 case sizes with wide capacitance and working voltage ranges means the TAP can accommodate almost any application.



Check for up-to-date CV Tables at
<http://www.avx.com/docs/catalogs/tap.pdf>

HOW TO ORDER

TAP

Type

475

Capacitance Code
 pF code: 1st two digits represent significant figures, 3rd digit represents multiplier (number of zeros to follow)

M

Capacitance Tolerance
 K = ±10%
 M = ±20%
 (For J = ±5% tolerance, please consult factory)

035

Rated DC Voltage

SCS

Suffix indicating wire form and packaging

Capacitance Range (letter denotes case size)

Capacitance		Rated voltage DC (V _R)						
μF	Code	6.3V	10V	16V	20V	25V	35V	50V
0.1	104						A	A
0.15	154						A	A
0.22	224						A	A
0.33	334						A	A
0.47	474						A	A
0.68	684						A	B
1.0	105				A	A	A	C
1.5	155			A	A	A	A	D
2.2	225		A	A	A	A	B	E
3.3	335	A	A	A	B	B	C	F
4.7	475	A	A	B	C	C	E	G
6.8	685	A	B	C	D	D	F	H
10	106	B	C	D	E	E	F	J
15	156	C	D	E	F	F	H	K
22	226	D	E	F	H	H	K	L
33	336	E	F	F	J	J	M	
47	476	F	G	J	K	M	N	
68	686	G	H	L	N	N		
100	107	H	K	N	N			
150	157	K	N	N				
220	227	M	P	R				
330	337	P	R					

Values outside this standard range may be available on request.

AVX reserves the right to supply capacitors to a higher voltage rating, in the same case size, than that ordered.

TEP Series

Dipped Radial Capacitors – Tin/Lead Finish

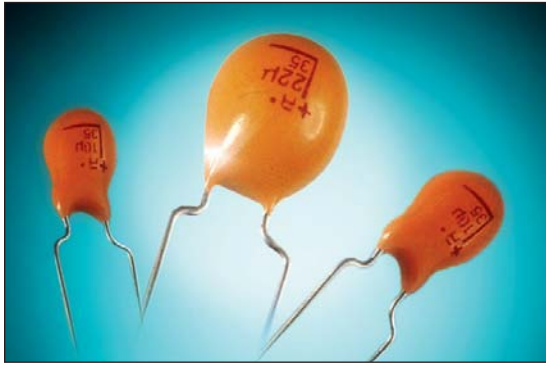

TEP is a Tin-Lead finish version of the conformally coated tantalum radial leaded capacitor (TAP). It is a professional grade device manufactured with a flame retardant coating and featuring low leakage current and impedance, very small physical sizes and exceptional temperature stability, available in bulk and T&R packaging for auto insertion. The wide range of Capacitance, working voltages and case sizes enables TEP to accommodate to almost any application.



Check for up-to-date CV Tables at
<http://www.avx.com/docs/catalogs/tep.pdf>

HOW TO ORDER

TEP

Type

106

Capacitance Code
 pF code: 1st two digits represent significant figures, 3rd digit represents multiplier (number of zeros to follow)

M

Capacitance Tolerance
 K = ±10%
 M = ±20%
 (For J = ±5% tolerance, please consult factory)

016

Rated DC Voltage

SCS

Suffix indicating wire form and packaging

Capacitance Range (letter denotes case size)								
Capacitance		Rated voltage DC (V _R)						
μF	Code	6.3V	10V	16V	20V	25V	35V	50V
0.1	104						A	A
0.15	154						A	A
0.22	224						A	A
0.33	334						A	A
0.47	474						A	A
0.68	684						A	B
1.0	105				A	A	A	C
1.5	155			A	A	A	A	D
2.2	225		A	A	A	A	B	E
3.3	335	A	A	A	B	B	C	F
4.7	475	A	A	B	C	C	E	G
6.8	685	A	B	C	D	D	F	H
10	106	B	C	D	E	E	F	J
15	156	C	D	E	F	F	H	K
22	226	D	E	F	H	H	K	L
33	336	E	F	F	J	J	M	
47	476	F	G	J	K	M	N	
68	686	G	H	L	N	N		
100	107	H	K	N	N			
150	157	K	N	N				
220	227	M	P	R				
330	337	P	R					

Values outside this standard range may be available on request.

AVX reserves the right to supply capacitors to a higher voltage rating, in the same case size, than that ordered.

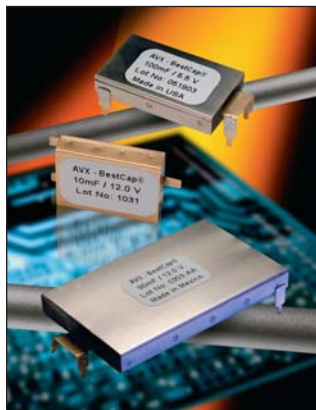

AVX's BestCap® technology provides excellent high power pulse characteristics based upon the combination of very high capacitance and ultra-low ESR, together with extremely low leakage current.

Based on a unique patented aqueous chemistry and an innovative design, this series offers high capacitance, even with short pulse applications such as in GSM, GPRS, Edge and PCS based systems.

While BestCap® technology offers more efficient energy savings in battery circuits than conventional supercapacitors, its Low ESR results in a high current handling capability, making this an ideal solution for any portable or wireless device requiring high power availability.

The Low Profile versions are ideally suited to PCMCIA, PDA, DSC and similar applications.

Check for up-to-date CV Tables at
<http://www.avx.com/docs/catalogs/bestcap.pdf>

HOW TO ORDER

BZ	0	1	5	A	503	Z	A	B	XX
BestCap®	Standard	Case Size 1 = 28mmx17mm 2 = 48mmx30mm 5 = 20mmx15mm 9 = 17mmx15mm	Rated Voltage 3 = 3.6V 4 = 4.5V 5 = 5.5V 9 = 9.0V C = 12.0V F = 15.0V	Series A = Maximum Capacitance B = Low Profile	Capacitance Code (Farad Code)	Capacitance Tolerance Z = (-20/+80)%	Lead Format A, C, H, L N or S	Packaging B = Bulk	Not Used For Standard Product (Consult Factory For Special Requirements)

A-SERIES – MAXIMUM CAPACITANCE									
Capacitance		Rated Voltage DC at 25°C							
mF	Code	3.6V		5.5V		9.0V		12.0V	
		Case Size	Lead Styles	Case Size	Lead Styles	Case Size	Lead Styles	Case Size	Lead Styles
10	103							BZ05	C, N, S
22	223							BZ01	A, C, H, S
33	333			BZ05	C, N, S	BZ01	A, C, H, S		
47	473								
50	503			BZ01	A, C, H, S				
68	683			BZ05	S				
70	703	BZ01	A, C, H, S						
90	903							BZ02	A, H, L
100	104			BZ01	A, H, S				
120	124					BZ02	A, H, L		
140	144	BZ01	A, H, S						
150	154								
200	204			BZ02	A, H, L				
280	284	BZ02	A, H, L						
400	404			BZ02	A, H, L				
560	564	BZ02	A, H, L						
1000	105			BZ12	A, H, L				

B-SERIES – LOW PROFILE													
Capacitance		Rated Voltage DC at 25°C											
mF	Code	3.6V		4.5V		5.5V		9.0V		12.0V		15.0V	
		Case Size	Lead Styles	Case Size	Lead Styles	Case Size	Lead Styles	Case Size	Lead Styles	Case Size	Lead Styles	Case Size	Lead Styles
6.8	682											BZ05	C, N, S
15	153			BZ09	N, S	BZ05	C, N, S			BZ01	A, H, S		
22	223			BZ05	N, S			BZ01	A, H, S				
30	303					BZ01	C, S						
33	333			BZ01	C, S	BZ05	S						
47	473			BZ15	N, S								
50	503	BZ01	C, S										
60	603					BZ01	A, H, S						
100	104	BZ11	C, S										

TLN PulseCap™ Series

Tantalum Solid Electrolytic Chip Capacitors



- Large case size for maximum capacitance
- 3x reflow 260°C compatible
- Low profile solution
- Consumer applications (e.g. PCMCIA/USB wireless express cards etc.)
- CV range: 1000-3300µF / 4-10V
- 2 case sizes available



[Check for up-to-date CV Tables at
http://www.avx.com/docs/catalogs/tlnpulse.pdf](http://www.avx.com/docs/catalogs/tlnpulse.pdf)

HOW TO ORDER

TLN	6	228	M	006	R	0055
Type	Case Size	Capacitance Code	Tolerance	Rated DC Voltage	Packaging	ESR in mΩ
		pF code: 1st two digits represent significant figures, 3rd digit represents multiplier	M = ±20%	004 = 4Vdc 006 = 6.3Vdc 010 = 10Vdc	R = Standard	

Capacitance		Voltage Rating DC (V _R) to 85°C		
µF	Code	4V (G)	6.3V (J)	10V (A)
1000	108			4(100)*/6(55)
1500	158		4(100)	6(55)
2200	228		6(55)	
3300	338	6(55)		

Available Codes (ESR ratings in mOhms in brackets)

Engineering samples - please contact manufacturer

*Codes under development – subject to change

Note: Voltage ratings are minimum values. AVX reserves the right to supply higher ratings in the same case size, to the same reliability standards.

Sub pF Varistor

AVX Multilayer Ceramic Transient Voltage Suppressors
ESD Protection for any Circuit Sensitive to Capacitance

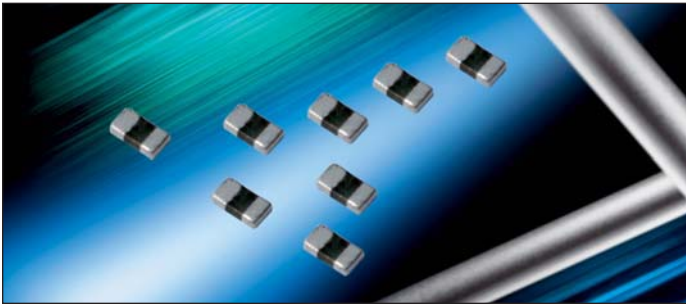

 Check for up-to-date CV Tables at
<http://www.avx.com/docs/catalogs/aguard-sub.pdf>

FEATURES

- High Reliability
- Capacitance <1pF
- Bi-Directional protection
- Fastest response time to ESD strikes
- Multi-strike capability
- Low insertion loss
- Low profile 0402 case size

GENERAL DESCRIPTION

AVX offers ultra-low capacitance ESD protection in the Sub 1pF range for use in circuits that are sensitive to capacitance. The Sub pF Varistor (SPV) is available in 0.8pF and 0.4pF capacitance values in a compact 0402 low profile package. SPV devices provide excellent response time to ESD strikes to protect sensitive circuits from over voltage conditions.

The development of new information processing technologies call for ever increasing digital system speeds. Higher speeds necessitate the use of ultra-low capacitance values in order to minimize signal distortion.

APPLICATIONS

- Antennas
- Optics
- HDMI
- RF circuits
- FlexRay
- Portable devices
- Analog sensors
- Any circuit sensitive to capacitance

HOW TO ORDER

VC	H4	AG	10	0R8	M	A	T	W	A
Varistor Chip	Chip Size	Varistor Series	Working Voltage	Capacitance	Tolerance	N/A	Termination	Reel Size	Reel Quantity
	Thin 0402	AntennaGuard	10 = 10V 15 = 15V	0R8 = 0.8pF 0R4 = 0.47pF	M = ±20%		T = Ni/Sn Alloy	W = 7"	A = 10k

ANTENNAGUARD CATALOG PART NUMBERS/ELECTRICAL VALUES

AVX Part Number	V _w (DC)	V _B	I _L	Cap	Cap Tolerance	3db Freq (MHz)	Case Size
VCH4AG100R8MA	≤10	125	<10 nA	0.8	±20%	5800	LP 0402
VCH4AG150R8MA	≤15	125	<10 nA	0.96 pF Max	Max	5800	LP 0402
VCH4AG150R4MA	≤15	135	<100 nA	0.47 pF Max	±20%	6700	LP 0402

- V_w(DC) DC Working Voltage (V)
V_B Typical Breakdown Voltage (V @ 1mA_{DC})
I_L Typical leakage current at the working voltage
Cap Typical capacitance (pF) @ frequency specified and 0.5V_{RMS}
Freq Frequency at which capacitance is measured (M = 1MHz)

TransFeed, Feedthrough Filter

AVX Multilayer Ceramic Transient Voltage Suppressors

TVS Protection and EMI Attenuation in a Single Chip

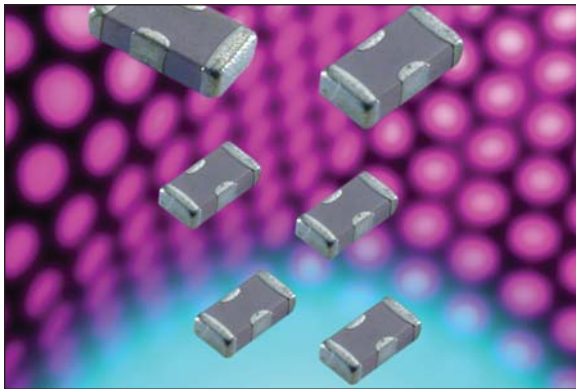

AVX has combined the best electrical characteristics of its TransGuard® Transient Voltage Suppressors (TVS) and its Feedthru Capacitors into a single chip for state-of-the-art overvoltage circuit protection and EMI reduction over a broad range of frequencies. This unique combination of multilayer ceramic construction in a feedthru configuration gives the circuit designer a single 0805 chip that responds to transient events faster than any TVS device on the market today, and provides significant EMI attenuation when in the off-state.

The reduction in parallel inductance, typical of the feedthru chip construction when compared to the construction of standard TVS or ceramic capacitor chips, gives the TransFeed product two very important electrical advantages: (1) faster “turn-on” time. Calculated response times of <200 pSec are not unusual with this device, and measured response times range from 200 – 250 pSec; (2) the second electrical advantage of lower parallel inductance, coupled with optimal series inductance, is the enhanced attenuation characteristics of the TransFeed product. Typical applications include filtering/protection on Microcontroller I/O Lines, Interface I/O Lines, Power Line Conditioning and Power Regulation.

Schematic Diagram

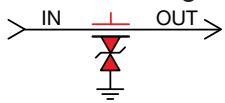

Electrical Model

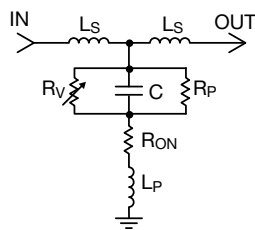

Check for up-to-date CV Tables at <http://www.avx.com/docs/catalogs/tfeed.pdf>

HOW TO ORDER

V T	2 T	F T	1 T	05 T	A T	150 T	Y T	2 T	E T	D T	P T
Varistor	Chip Size 2 = 0805 3 = 0612	Feedthru Capacitor	No. of Elements	Voltage 05 = 5.6VDC 09 = 9.0VDC 14 = 14.0VDC 18 = 18.0VDC	Energy Rating X = 0.05J A = 0.1J C = 0.3J	Varistor Clamping Voltage 150 = 18V 200 = 22V 300 = 32V 400 = 42V 500 = 50V	Capacitance Tolerance Y = +100/-50%	DC Resistance 1 = 0.150 Ohms 2 = 0.200 Ohms 3 = 0.250 Ohms	Feedthru Current D = 500 mA E = 750 mA F = 1.0 Amp	Packaging Code Pcs./Reel D = 1,000 R = 4,000 T = 10,000	Termination Finish P = Ni/Sn Alloy (Plated) M = Ni/Sn Pb (Plated)

TRANSFEED ELECTRICAL SPECIFICATIONS

AVX Part Number	Working Voltage (DC)	Working Voltage (AC)	Breakdown Voltage	Clamping Voltage	Maximum Leakage Current	Transient Energy Rating	Peak Current Rating	Typical Cap	DC Resistance	Maximum Feedthru Current
V2F105A150Y2E __	5.6	4.0	8.5±20%	18	35	0.10	30	800	0.200	0.75
V2F105C150Y1F __	5.6	4.0	8.5±20%	18	35	0.30	120	2500	0.150	1.00
V2F109A200Y2E __	9.0	6.4	12.7±15%	22	25	0.10	30	575	0.200	0.75
V2F109C200Y1F __	9.0	6.4	12.7±15%	22	25	0.30	120	1800	0.150	1.00
V2F114A300Y2E __	14.0	10.0	18.5±12%	32	15	0.10	30	300	0.200	0.75
V2F114C300Y1F __	14.0	10.0	18.5±12%	32	15	0.30	120	900	0.150	1.00
V2F118A400Y2E __	18.0	13.0	25.5±10%	42	10	0.10	30	200	0.200	0.75
V2F118C400Y1F __	18.0	13.0	25.5±10%	42	10	0.30	120	500	0.150	1.00
V2F118X500Y3D __	18.0	13.0	25.5±10%	50	10	0.05	20	75	0.250	0.50

Termination Finish Code
Packaging Code

TransFeed Array Filter

AVX Multilayer Ceramic Transient Voltage Suppressors

TVS Protection and EMI Attenuation in a Single Chip

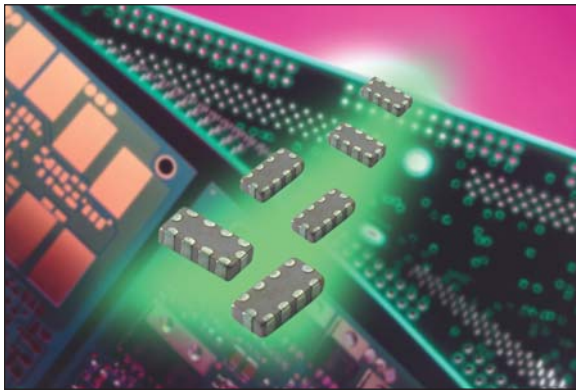

AVX has combined the best electrical characteristics of its TransGuard® Transient Voltage Suppressors (TVS) and its Feedthru Capacitors into a single chip for state-of-the-art overvoltage circuit protection and EMI reduction over a broad range of frequencies. This unique combination of multilayer ceramic construction in a feedthru configuration gives the circuit designer a single 0805 chip that responds to transient events faster than any TVS device on the market today, and provides significant EMI attenuation when in the off-state.

The reduction in parallel inductance, typical of the feedthru chip construction when compared to the construction of standard TVS or ceramic capacitor chips, gives the TransFeed product two very important electrical advantages: (1) faster “turn-on” time. Calculated response times of <200 pSec are not unusual with this device, and measured response times range from 200 – 250 pSec; (2) the second electrical advantage of lower parallel inductance, coupled with optimal series inductance, is the enhanced attenuation characteristics of the TransFeed product. Typical applications include filtering/protection on Microcontroller I/O Lines, Interface I/O Lines, Power Line Conditioning and Power Regulation.

Schematic Diagram

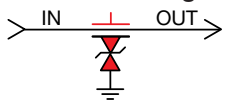

Electrical Model

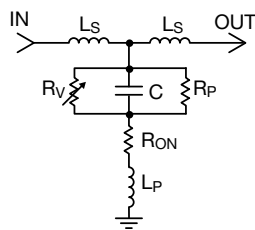

Check for up-to-date CV Tables at
<http://www.avx.com/docs/catalogs/tfeed.pdf>

HOW TO ORDER

V	3	F	4	18	X	500	Y	3	G	D	P
Array	Chip Size	Feedthru Capacitor	No. of Elements	Voltage	Energy Rating	Varistor Clamping Voltage	Capacitance Tolerance	DC Resistance	Feedthru Current	Packaging Code	Termination Finish
	2 = 0805 3 = 0612			18 = 18.0VDC	X = 0.05J A = 0.1J	400 = 42V 500 = 50V	Y = +100/-50%	3 = 0.250 Ohms	G = 200 mA	D = 1,000 R = 4,000 T = 10,000	P = Ni/Sn Alloy (Plated) M = Ni/Sn Pb (Plated)

AVX Part Number	Working Voltage (DC)	Working Voltage (AC)	Breakdown Voltage	Clamping Voltage	Maximum Leakage Current	Transient Energy Rating	Peak Current Rating	Typical Cap	DC Resistance	Maximum Feedthru Current
V3F418A400Y3G__	18.0	13.0	25.5±10%	42	10	0.10	20	150	0.200	0.30
V3F418X500Y3G__	18.0	13.0	25.5±10%	50	10	0.05	15	65	0.250	0.20

Termination Finish Code
 Packaging Code

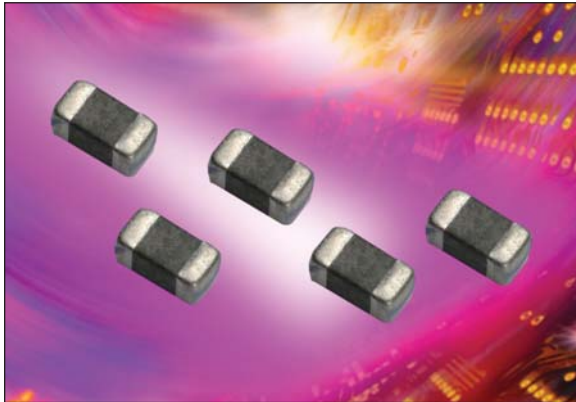

TransGuard® acts as an EMI filter in the “off state” and a transient voltage suppressor in the “on state”. They are bidirectional and therefore act as back to back zener diodes, but offer other advantages, for example, fast turn-on time (sub 1ns) and repetitive strike capability. Package options include EIA case sizes 0402, 0603, 0805, 1206, 1210, 1812 and 2220, as well as axial leaded configuration.

DESC drawing Series AA55562

[Check for up-to-date CV Tables at http://www.avx.com/docs/catalogs/tguard.pdf](http://www.avx.com/docs/catalogs/tguard.pdf)

PART NUMBER IDENTIFICATION

Surface Mount Devices

Important: For part number identification only, not for construction of part numbers.

The information below only defines the numerical value of part number digits, and cannot be used to construct a desired set of electrical limits. Please refer to the TransGuard® part number data for the correct electrical ratings.

V Product Designator V = Varistor	C Case Style C = Chip	1206 Case Size Designator	05 Working Voltage	D Energy	150 Clamping* Voltage	R Packaging (Pcs/Reel)	M Termination Finish M = Ni/Sn Pb (Plated)																																																																																																
		<table border="1" style="width: 100%; border-collapse: collapse; text-align: center;"> <thead> <tr> <th>Size</th> <th>Length</th> <th>Width</th> </tr> </thead> <tbody> <tr> <td>0402</td> <td>1.00±0.10mm (0.040"±0.004")</td> <td>0.5±0.10mm (0.020"±0.004")</td> </tr> <tr> <td>0603</td> <td>1.60±0.15mm (0.063"±0.006")</td> <td>0.8±0.15mm (0.032"±0.006")</td> </tr> <tr> <td>0805</td> <td>2.01±0.2mm (0.079"±0.008")</td> <td>1.25±0.2mm (0.049"±0.008")</td> </tr> <tr> <td>1206</td> <td>3.20±0.2mm (0.126"±0.008")</td> <td>1.60±0.2mm (0.063"±0.008")</td> </tr> <tr> <td>1210</td> <td>3.20±0.2mm (0.126"±0.008")</td> <td>2.49±0.2mm (0.098"±0.008")</td> </tr> </tbody> </table>	Size	Length	Width	0402	1.00±0.10mm (0.040"±0.004")	0.5±0.10mm (0.020"±0.004")	0603	1.60±0.15mm (0.063"±0.006")	0.8±0.15mm (0.032"±0.006")	0805	2.01±0.2mm (0.079"±0.008")	1.25±0.2mm (0.049"±0.008")	1206	3.20±0.2mm (0.126"±0.008")	1.60±0.2mm (0.063"±0.008")	1210	3.20±0.2mm (0.126"±0.008")	2.49±0.2mm (0.098"±0.008")	<table border="0" style="width: 100%;"> <tr> <td>03 = 3.3 VDC</td> <td>05 = 5.6 VDC</td> <td>09 = 9.0 VDC</td> <td>12 = 12.0 VDC</td> <td>14 = 14.0 VDC</td> <td>18 = 18.0 VDC</td> <td>26 = 26.0 VDC</td> <td>30 = 30.0 VDC</td> <td>48 = 48.0 VDC</td> <td>60 = 60.0 VDC</td> </tr> </table>	03 = 3.3 VDC	05 = 5.6 VDC	09 = 9.0 VDC	12 = 12.0 VDC	14 = 14.0 VDC	18 = 18.0 VDC	26 = 26.0 VDC	30 = 30.0 VDC	48 = 48.0 VDC	60 = 60.0 VDC	<table border="0" style="width: 100%;"> <tr> <td>A = 0.1J</td> <td>N = 1.1J</td> </tr> <tr> <td>B = 0.2J</td> <td>P = 3.0J</td> </tr> <tr> <td>C = 0.3J</td> <td>Q = 1.3J</td> </tr> <tr> <td>D = 0.4J</td> <td>R = 1.7J</td> </tr> <tr> <td>E = 0.5J</td> <td>S = 1.9-2.0J</td> </tr> <tr> <td>F = 0.7J</td> <td>T = 0.01J</td> </tr> <tr> <td>G = 0.9J</td> <td>U = 4.0-5.0J</td> </tr> <tr> <td>H = 1.2J</td> <td>V = 0.02J</td> </tr> <tr> <td>J = 1.5J</td> <td>W = 6.0J</td> </tr> <tr> <td>K = 0.6J</td> <td>X = 0.05J</td> </tr> <tr> <td>L = 0.8J</td> <td>Y = 12.0J</td> </tr> <tr> <td>M = 1.0J</td> <td>Z = 25.0J</td> </tr> </table>	A = 0.1J	N = 1.1J	B = 0.2J	P = 3.0J	C = 0.3J	Q = 1.3J	D = 0.4J	R = 1.7J	E = 0.5J	S = 1.9-2.0J	F = 0.7J	T = 0.01J	G = 0.9J	U = 4.0-5.0J	H = 1.2J	V = 0.02J	J = 1.5J	W = 6.0J	K = 0.6J	X = 0.05J	L = 0.8J	Y = 12.0J	M = 1.0J	Z = 25.0J	<table border="0" style="width: 100%;"> <tr> <td>100 = 12V</td> <td>150 = 18V</td> <td>200 = 22V</td> <td>250 = 27V</td> <td>300 = 32V</td> <td>390 = 42V</td> <td>400 = 42V</td> <td>500 = 50V</td> <td>560 = 60V</td> <td>580 = 60V</td> <td>620 = 67V</td> <td>650 = 67V</td> <td>101 = 100V</td> <td>121 = 120V</td> </tr> </table>	100 = 12V	150 = 18V	200 = 22V	250 = 27V	300 = 32V	390 = 42V	400 = 42V	500 = 50V	560 = 60V	580 = 60V	620 = 67V	650 = 67V	101 = 100V	121 = 120V	<table border="1" style="width: 100%; border-collapse: collapse; text-align: center;"> <thead> <tr> <th>Style</th> <th>"D"</th> <th>"R"</th> <th>"T"</th> <th>"W"</th> </tr> </thead> <tbody> <tr> <td>VC0402</td> <td>N/A</td> <td>N/A</td> <td>N/A</td> <td>10,000</td> </tr> <tr> <td>VC0603</td> <td>1,000</td> <td>4,000</td> <td>10,000</td> <td>N/A</td> </tr> <tr> <td>VC0805</td> <td>1,000</td> <td>4,000</td> <td>10,000</td> <td>N/A</td> </tr> <tr> <td>VC1206</td> <td>1,000</td> <td>4,000</td> <td>10,000</td> <td>N/A</td> </tr> <tr> <td>VC1210</td> <td>1,000</td> <td>2,000</td> <td>10,000</td> <td>N/A</td> </tr> </tbody> </table>	Style	"D"	"R"	"T"	"W"	VC0402	N/A	N/A	N/A	10,000	VC0603	1,000	4,000	10,000	N/A	VC0805	1,000	4,000	10,000	N/A	VC1206	1,000	4,000	10,000	N/A	VC1210	1,000	2,000	10,000	N/A	
Size	Length	Width																																																																																																					
0402	1.00±0.10mm (0.040"±0.004")	0.5±0.10mm (0.020"±0.004")																																																																																																					
0603	1.60±0.15mm (0.063"±0.006")	0.8±0.15mm (0.032"±0.006")																																																																																																					
0805	2.01±0.2mm (0.079"±0.008")	1.25±0.2mm (0.049"±0.008")																																																																																																					
1206	3.20±0.2mm (0.126"±0.008")	1.60±0.2mm (0.063"±0.008")																																																																																																					
1210	3.20±0.2mm (0.126"±0.008")	2.49±0.2mm (0.098"±0.008")																																																																																																					
03 = 3.3 VDC	05 = 5.6 VDC	09 = 9.0 VDC	12 = 12.0 VDC	14 = 14.0 VDC	18 = 18.0 VDC	26 = 26.0 VDC	30 = 30.0 VDC	48 = 48.0 VDC	60 = 60.0 VDC																																																																																														
A = 0.1J	N = 1.1J																																																																																																						
B = 0.2J	P = 3.0J																																																																																																						
C = 0.3J	Q = 1.3J																																																																																																						
D = 0.4J	R = 1.7J																																																																																																						
E = 0.5J	S = 1.9-2.0J																																																																																																						
F = 0.7J	T = 0.01J																																																																																																						
G = 0.9J	U = 4.0-5.0J																																																																																																						
H = 1.2J	V = 0.02J																																																																																																						
J = 1.5J	W = 6.0J																																																																																																						
K = 0.6J	X = 0.05J																																																																																																						
L = 0.8J	Y = 12.0J																																																																																																						
M = 1.0J	Z = 25.0J																																																																																																						
100 = 12V	150 = 18V	200 = 22V	250 = 27V	300 = 32V	390 = 42V	400 = 42V	500 = 50V	560 = 60V	580 = 60V	620 = 67V	650 = 67V	101 = 100V	121 = 120V																																																																																										
Style	"D"	"R"	"T"	"W"																																																																																																			
VC0402	N/A	N/A	N/A	10,000																																																																																																			
VC0603	1,000	4,000	10,000	N/A																																																																																																			
VC0805	1,000	4,000	10,000	N/A																																																																																																			
VC1206	1,000	4,000	10,000	N/A																																																																																																			
VC1210	1,000	2,000	10,000	N/A																																																																																																			

Marking

All standard surface mount TransGuard® chips will **not** be marked.

ELECTRICAL CHARACTERISTICS RANGE

Range	Working Voltage (DC)	Breakdown Voltage	Clamping Voltage	Test Current For V _c	Maximum Leakage Current	Transient Energy Rating	Peak Current Rating	Typical Cap
Lowest Value	3.3	5.0±20%	12	1	100	0.05	20	65
Highest Value	65	82.0±10%	135	10	10	4.80	800	5000

* Please check the AVX website for actual clamping to working voltage available on these devices.

MultiGuard TVS Array

AVX Multilayer Ceramic Transient Voltage Suppression

Arrays – ESD Protection for CMOS and Bi Polar Systems

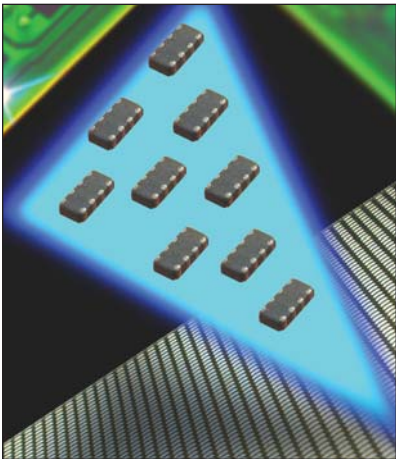

AVX's Transient Voltage Suppression (TVS) Arrays address six trends in today's electronic circuits: (1) mandatory ESD protection, (2) mandatory EMI control, (3) signal integrity improvement, (4) PCB downsizing, (5) reduced component placement costs, and (6) protection from induced slow speed transient voltages and currents.

AVX's MultiGuard products offer numerous advantages, which include a faster turn-on-time (<1nS), repetitive strike capability, and space savings. In some cases, MultiGuard consumes less than 75% of the PCB real estate required for the equivalent number of discrete chips. This size advantage, coupled with the savings associated with placing only one chip, makes MultiGuard the TVS component of choice for ESD protection of I/O lines in portable equipment and programming ports in cellular phones. Other applications include differential data line protection, ASIC protection and LCD driver protection for portable computing devices.

Where multiple lines require the ESD protection, the 4-element 0612 or 0508 chip is an ideal solution. While the 2-element 0405 MultiGuard is the smallest TVS array, the 4-element 0508 MultiGuard is the smallest 4-element TVS device available in the market today.

Available with standard working voltage of 5.6V up to 18V with low capacitance in the 3 case sizes, AVX MultiGuard arrays offer a very broad range of integrated TVS solutions to the design community.

Check for up-to-date CV Tables at <http://www.avx.com/docs/catalogs/tguard.pdf>

HOW TO ORDER

MG	04	2	L	14	A	300	T	P
MultiGuard	Case Size	Configuration	Style	Working Voltage	Energy Rating	Clamping Voltage	Packaging (PCS/REEL)	Termination Finish
	04 = 0405 05 = 0508 06 = 0612	2 = 2 Elements 4 = 4 Elements	S = Standard Construction L = Low Capacitance	05 = 5.6VDC 09 = 9.0VDC 14 = 14.0VDC 18 = 18.0VDC	A = 0.10 Joules V = 0.02 Joules X = 0.05 Joules	150 = 18V 200 = 22V 300 = 32V 400 = 42V 500 = 50V	D = 1,000 R = 4,000 T = 10,000	P = Ni/Sn Alloy (Plated) M = Ni/Sn Pb (Plated)

ELECTRICAL CHARACTERISTICS PER ELEMENT

	AVX Part Number	Working Voltage (DC)	Working Voltage (AC)	Breakdown Voltage	Clamping Voltage	Test Current For V _c	Maximum Leakage Current	Transient Energy Rating	Peak Current Rating	Typical Cap
2 Element 0405 Chip	MG042S05X150 __	5.6	4.0	8.5±20%	18	1	35	0.05	15	300
	MG042L14V400 __	14.0	10.0	18.5±12%	32	1	15	0.02	15	45
	MG042L18V500 __	18.0	14.0	N/A	50	1	10	0.02	15	40
2 Element 0508 Chip	MG052S05A150 __	5.6	4.0	8.5±20%	18	1	35	0.10	30	825
	MG052S09A200 __	9.0	6.4	12.7±15%	22	1	25	0.10	30	550
	MG052S14A300 __	14.0	10.0	19.5±12%	32	1	15	0.10	30	425
	MG052S18A400 __	18.0	14.0	25.5±10%	42	1	10	0.10	30	225
	MG052L18X500 __	≤18.0	≤14.0	N/A	50	1	10	0.10	20	50
4 Element 0508 Chip	MG054S05X150 __	5.6	4.0	8.5±20%	18	1	35	0.05	15	400
	MG054S09X200 __	9.0	6.4	12.7±15%	22	1	25	0.05	15	300
	MG054S14X300 __	14.0	10.0	19.5±12%	32	1	15	0.05	15	150
	MG054S18X400 __	18.0	14.0	25.5±10%	42	1	10	0.05	15	120
	MG054L18V500 __	≤18.0	≤14.0	N/A	50	1	10	0.02	15	50
4 Element 0612 Chip	MG064S05A150 __	5.6	4.0	8.5±20%	18	1	35	0.10	30	825
	MG064S09A200 __	9.0	6.4	12.7±15%	22	1	25	0.10	30	550
	MG064S14A300 __	14.0	10.0	19.5±12%	32	1	15	0.10	30	425
	MG064S18A400 __	18.0	14.0	25.5±10%	42	1	10	0.05	15	120
	MG064L18X500 __	≤18.0	≤14.0	N/A	50	1	10	0.10	20	75

Termination Finish Code	V _w (DC)	DC Working Voltage (V)	V _c	Clamping Voltage (V @ I _c)
Packaging Code	V _w (AC)	AC Working Voltage (V)	I _c	Test Current for V _c (A, 8x20μS)
	V _B	Typical Breakdown Voltage (V @ 1mA _{DC})	I _L	Maximum Leakage Current at the Working Voltage (μA)
	V _B Tol	V _B Tolerance is ± from Typical Value	E _T	Transient Energy Rating (J, 10x1000μS)
			I _p	Peak Current Rating (A, 8x20μS)
			Cap	Typical Capacitance (pF) @ 1MHz and 0.5 V _{RMS}

NB12, Surface Mount Thermistors

NC 12 – NC 20



Chip thermistors are a high quality and low cost device especially developed for surface mounting applications. They are widely used for temperature compensation but can also achieve temperature control of printed circuits. Its silver - palladium - platinum metallization provides a high degree of resistance to dewetting of the terminations during soldering (typically 260°C / 30 s).

 Check for up-to-date CV Tables at
<http://www.avx.com/docs/catalogs/nb12-20.pdf>

HOW TO ORDER

NC 20

Type

K 0

Material Code
K

0103

Resistance
10,000 Ω

M

Tolerance
M (±20%)
J (±5%)
K (±10%)

BA

Suffix: Packaging
 --: Bulk
 BA: Plastic tape (180mm diam. reel)
 BE: Plastic tape (1/2 reel)
 BC: Plastic tape (330mm diam. reel)
 BB: Cardboard tape (180mm diam. reel)
 BF: Cardboard tape (1/2 reel)
 BD: Cardboard tape (330mm diam. reel)

TABLE OF VALUES (Min/Max)

NC 12 IEC SIZE : 0805				
Types	Rn at 25°C (Ω)	Material Code	B (K) ($\frac{\Delta B}{B}$ (1) ± 5% (2) ± 3%)	α at 25°C (%/°C)
NC 12 KC 0 180 NC 12 KC 0 101	18 100	KC	3470 ± 5%	- 3.9
NC 12 MC 0 121 NC 12 MC 0 332	120 3,300	MC	3910 ± 3%	- 4.4
NC 12 J 0 0332 NC 12 J 0 0562	3,300 5,600	J	3480 ± 3%	- 3.9
NC 12 K 0 0682 NC 12 K 0 0123	6,800 12,000	K	3630 ± 3%	- 4.0
NC 12 L 0 0153 NC 12 L 0 0183	15,000 18,000	L	3790 ± 3%	- 4.2
NC 12 M 0 0223 NC 12 M 0 0393	22,000 39,000	M	3950 ± 3%	- 4.4
NC 12 N 0 0473 NC 12 N 0 0563	47,000 56,000	N	4080 ± 3%	- 4.6
NC 12 L 2 0683 NC 12 N 0 0823	68,000 82,000	L2 N	3805 ± 3% 4080 ± 3%	- 4.1 - 4.6
NC 12 P 0 0104 NC 12 P 0 0184	100,000 180,000	P	4220 ± 3%	- 4.7
NC 12 Q 0 0224	220,000	Q	4300 ± 3%	-4.7

NC 20 IEC SIZE : 1206				
Types	Rn at 25°C (Ω)	Material Code	B (K) ($\frac{\Delta B}{B}$ (1) ± 5% (2) ± 3%)	α at 25°C (%/°C)
NC 20 KC 0 100 NC 20 KC 0 101	10 100	KC	3470 ± 5%	- 3.9
NC 20 MC 0 121 NC 20 MC 0 152	120 1,500	MC	3910 ± 3%	- 4.4
NC 20 I 0 0182 NC 20 I 0 0332	1,800 3,300	I	3250 ± 5%	- 3.7
NC 20 J 0 0392 NC 20 J 0 0682	3,900 6,800	J	3480 ± 3%	- 3.9
NC 20 K 0 0822 NC 20 K 0 0153	8,200 15,000	K	3630 ± 3%	- 4.0
NC 20 L 0 0183 NC 20 L 0 0223	18,000 22,000	L	3790 ± 3%	- 4.2
NC 20 M 0 0273 NC 20 M 0 0473	27,000 47,000	M	3950 ± 3%	- 4.4
NC 20 N 0 0563 NC 20 N 0 0104	56,000 100,000	N	4080 ± 3%	- 4.6
NC 20 P 0 0124 NC 20 P 0 0224	120,000 220,000	P	4220 ± 3%	- 4.7
NC 20 Q 0 0274 NC 20 Q 0 0474	270,000 470,000	Q	4300 ± 3%	- 4.7
NC 20 R 0 0564 NC 20 R 0 0105	560,000 1,000,000	R	4400 ± 3%	- 4.8

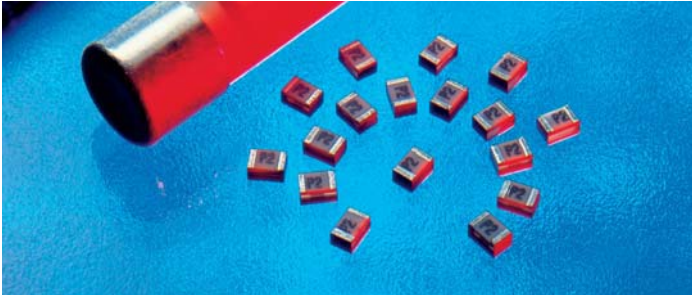

Accu-Guard® II is a version of Accu-Guard® fuses for a wider range of current and voltage ratings. Constructed on alumina substrates, Accu-Guard® II fuses display superior electrical, mechanical and environmental properties. Accu-Guard® II dimensions are standard 0402, 0603, 0805, 1206 and 0612 chip sizes.

[Check for up-to-date CV Tables at http://www.avx.com/docs/catalogs/fuses.pdf](http://www.avx.com/docs/catalogs/fuses.pdf)

HOW TO ORDER

F
Product
Fuse

1206
Size
See table for standard sizes

A
Fuse Version
A=Accu-Guard®
B=Accu-Guard® II
C=Accu-Guard® II 0603
D=Accu-Guard® II 0612
E=Accu-Guard® II 0402, 0603

0R20
Rated Current
Current expressed in Amps. Letter R denotes decimal point. e.g. 0.20A=0R20
1.75A=1R75

F
Fuse Speed
F=Fast

W
Termination
S=Nickel/Lead-Free Solder coated (Sn 100)
W=Nickel/solder coated (Sn 63, Pb 37)

TR
Packaging
TR=Tape and reel

Type	Part Number	Current Rating A	Resistance 10% x I rated, 25°C Ω (max.)	Voltage Drop @1 x I rated, 25°C mV (max.)	Fusing Current (within 5 sec), 25°C A	Pre-Arc I ² t @ 50A A ² -sec	Rated Voltage V
F0402E	F0402E0R25FSTR	0.25	0.650	220	0.625	0.00005*	32
	F0402E0R50FSTR	0.50	0.250	180	1.25	0.0003	32
	F0402E0R75FSTR	0.75	0.200	180	1.875	0.003	32
	F0402E1R00FSTR	1.00	0.130	160	2.50	0.008	32
	F0402E1R50FSTR	1.50	0.060	140	3.75	0.03	32
	F0402E2R00FSTR	2.00	0.040	120	5.00	0.06	32
F0603E	F0603E0R25FSTR	0.25	0.650	220	0.625	0.00005*	32
	F0603E0R37FSTR	0.375	0.450	220	0.940	0.0001	32
	F0603E0R50FSTR	0.50	0.250	180	1.25	0.0003	32
	F0603E0R75FSTR	0.75	0.200	180	1.875	0.003	32
	F0603E1R00FSTR	1.00	0.130	160	2.50	0.008	32
	F0603E1R25FSTR	1.25	0.090	140	3.125	0.01	32
	F0603E1R50FSTR	1.50	0.060	140	3.75	0.03	32
	F0603E1R75FSTR	1.75	0.050	120	4.375	0.04	32
	F0603E2R00FSTR	2.00	0.040	120	5.00	0.06	32
	F0603E2R50FSTR	2.50	0.035	100	6.25	0.12	32
F0603C	F0603E3R00FSTR	3.00	0.030	100	7.50	0.25	32
	F0603C0R25FWTR	0.25	0.800	280	0.50	0.00003*	32
	F0603C0R37FWTR	0.375	0.500	280	0.75	0.0001	32
	F0603C0R50FWTR	0.50	0.320	280	1.00	0.0002	32
	F0603C0R75FWTR	0.75	0.300	280	1.50	0.0015	32
	F0603C1R00FWTR	1.00	0.200	240	2.00	0.004	32
	F0603C1R25FWTR	1.25	0.170	240	2.50	0.007	32
	F0603C1R50FWTR	1.50	0.110	240	3.00	0.012	32
	F0603C1R75FWTR	1.75	0.090	240	3.50	0.02	24
	F0603C2R00FWTR	2.00	0.075	240	4.00	0.03	24
F0805B	F0603C2R50FWTR	2.50	0.055	200	5.00	0.05	16
	F0603C3R00FWTR	3.00	0.045	200	6.00	0.1	16
	F0805B0R25FWTR	0.25	0.750	280	0.50	0.00003*	63
	F0805B0R50FWTR	0.50	0.350	280	1.00	0.0002	63
	F0805B0R75FWTR	0.75	0.270	280	1.50	0.001	63
	F0805B1R00FWTR	1.00	0.220	280	2.00	0.003	63
	F0805B1R25FWTR	1.25	0.170	280	2.50	0.007	63
	F0805B1R50FWTR	1.50	0.120	240	3.00	0.010	63
	F0805B2R00FWTR	2.00	0.080	220	4.00	0.030	63
F1206B	F0805B2R50FWTR	2.50	0.060	220	5.00	0.050	63
	F0805B3R00FWTR	3.00	0.050	220	6.00	0.10	63
	F1206B0R25FWTR	0.25	0.750	280	0.50	0.00003	63
	F1206B0R50FWTR	0.50	0.350	280	1.00	0.0002	63
	F1206B1R00FWTR	1.00	0.180	240	2.00	0.003	63
	F1206B1R50FWTR	1.50	0.120	240	3.00	0.010	63
F0612D	F1206B2R00FWTR	2.00	0.080	220	4.00	0.030	63
	F1206B3R00FWTR	3.00	0.050	220	6.00	0.10	63
	F0612D4R00FWTR	4.00	0.040	260	10	0.10	32
	F0612D5R00FWTR	5.00	0.025	200	12.5	0.25	32

*Current is limited to less than 50A at 32V due to internal fuse resistance.

CERAMIC CAPACITORS



Surface Mount Multilayer Ceramic Capacitors

MIL PRF 123* DSCC 03028(0603)*
 MIL PRF 55681 (CDR) DSCC 05001 (0805)*
 DSCC 03029 (0402)* DSCC 05006(0805)*
 DSCC 05002 (0603)* ESCC 3009
 DSCC 05007 (1206)* CECC 32101
 AEC Q200 (Automotive) Medical Grade
 Professional Series (APS)
 LD Series (Tin/Lead Termination)

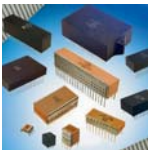

Switch Mode Power Supply Capacitors (SMPS)

DSCC 87106/88011
 MIL PRF 49470 (M and T Levels)
 CECC 30601
 CECC 30701
 TurboCap™



Leaded Multilayer Ceramic Capacitors

MIL PRF 20 ESCC 3001
 MIL C 11015 CECC 30601
 MIL PRF 123 CECC 30701
 MIL PRF 39014



High Voltage

DSCC 87046 DSCC 87114
 DSCC 87043 DSCC 87047
 DSCC 87040 DSCC 87076
 DSCC 87077 DSCC 89044
 DSCC 87070 DSCC 87081
 AEC Q200* MIL 49467 (Compliant)

Leaded Capacitor Arrays (SIP)

DSCC 87112 DSCC 87120
 DSCC 87116 DSCC 87122
 DSCC 87119 DSCC 88019
 DSCC 89086

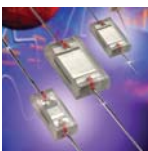

Glass Capacitor

MIL PRF 23269
 MIL C 11272

TANTALUM CAPACITORS

Surface Mount Tantalum Capacitors

MIL PRF 55365 (CWR)
 MIL PRF 55365 (T Level - Space)
 SRC 9000 (NASA)*
 ESCC 3012
 CECC 30801
 DSCC 07016 (Low ESR)*
 DSCC 95158*
 DSCC 04053 (Fused)*
 DSCC 09009 (Module)*
 COTS-Plus Tin/Lead Termination
 Medical Grade
 HRC 5000

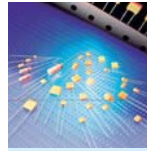

Leaded Tantalum Capacitors

CECC 30201
 Dipped Radial

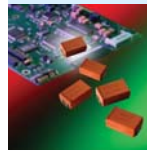

Niobium Oxide / OxiCap®

COTS-Plus



Wet Tantalum

DSCC 93026*

RF CAPACITORS



Surface Mount Multilayer Ceramic Capacitors

MIL PRF 55681 (CDR11-14)
 DSCC 06019*
 DSCC 06022*

CIRCUIT PROTECTION



MLV Transient Voltage Suppressors

DSCC AA555682

*New Addition

LOW INDUCTANCE/SIGNAL INTEGRITY

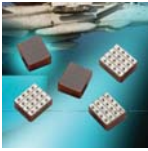

Low Inductance Capacitor Array
MIL C 123 Compliant
LD Series (Tin/Lead)



EMI Filters
MIL PRF 28861 MIL PRF 15733
NASA SSQ 21215-21218 Medical Grade

CONNECTORS

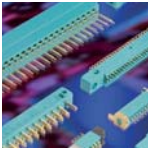

MIL C 55074 Hermaphrocom Style
M55032 Din
Rack and Panel

ESTABLISHED RELIABILITY PRODUCTS



Film Capacitors
High Voltage Film
Medium Power Film
DC Filtering Caps



EMI Filters (SMD)
Feedthru Cap and Array
High Current Filters
Transfeed (Transient + Feed Thru)



Circuit Protection
Transient Protection
Thermistor
Fuse



Pulse Power
BestCap® Supercapacitor
PulseCap™

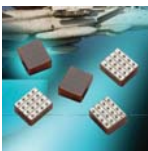

Signal Integrity
Low Inductance Capacitors
Low Inductance Arrays

TESTING CAPABILITIES

DPA
Solderability
Group A
Group B
Group C
Source Inspection
Thermal Shock
Life Test



Low Voltage Humidity
Volt Temperature Limits
Moisture Sensitivity
Temperature Cycling
X-Ray Analysis
Ultrasonic Scan
CSAM Scanning
SEM (Scanning Electron Microscope)



Terminal Strength
Matched Pairs
Failure Analysis
NAVAR Solderability
Resistance to Solder Heat
Thermal Shock



HALT Testing
Low Voltage Breakdown
ESR Testing
Pulse Testing
Barometric Testing



Salt Fog
First Article
Surge Testing
Hi Frequency Testing
Low Frequency Testing
Power Testing
Lightning Strikes (DO 160)
RF Characterization
Transient Analysis
Shake And Vibration
Weibull Testing
PMAE Test

TAZ Series

CWR09 - MIL-PRF-55365/4 Established Reliability, COTS-Plus & Space Level



This is the original high reliability molded tantalum chip series and the case sizes still represent the most flexible of surface mount form factors. TAZ offers nine case sizes, eight of which (A through H) are fully qualified to MIL-PRF-55365/4, and also includes the original sub-miniature R case (non-QPL).

This series is fully interchangeable with CWR06 conformal types, while offering the advantages of molded body / compliant termination construction (ensuring no TCE mismatch with any substrate). This construction is compatible with a wide range of SMT board assembly processes including wave or reflow solder, conductive epoxy or compression bonding techniques.

The parts also carry full polarity and capacitance / voltage marking. The five smaller cases are characterized by their low profile construction, with the A

case being the world's smallest molded military tantalum chip.

All 4V to 50V ratings are qualified to MIL-PRF-55365 Weibull "B", "C", "D" and "T" levels, with all surge options ("A", "B" & "C") available.

For Space Level applications, AVX SRC 9000 qualification is recommended (see ratings table for part number availability).

There are four termination finishes available: solder plated, fused solder plated, hot solder dipped and gold plated (these are "H", "K", "C" and "B" termination, respectively, per MIL-PRF-55365). In addition, the molding compound has been selected to meet the requirements of UL94V-0 (Flame Retardancy) and outgassing requirements of NASA SP-R-0022A.

Check for up-to-date CV Tables at <http://www.avx.com/docs/catalogs/taz.pdf>

HOW TO ORDER

COTS-PLUS & MIL QPL (CWR09):

TAZ	H	686	*	006	C	□	#	@	0	^	++
Type	Case Size	Capacitance Code pF code: 1st two digits represent significant figures 3rd digit represents multiplier (number of zeros to follow)	Capacitance Tolerance M = ±20% K = ±10% J = ±5%	Voltage Code 004 = 4Vdc 006 = 6Vdc 010 = 10Vdc 015 = 15Vdc 020 = 20Vdc 025 = 25Vdc 035 = 35Vdc 050 = 50Vdc	Standard or Low ESR Range C = Std ESR L = Low ESR	Packaging B = Bulk R = 7" T&R S = 13" T&R W = Waffle	Inspection Level S = Std. Conformance L = Group A M = MIL (JAN) CWR09	Reliability Grade Weibull: B = 0.1%/1000 hrs. 90% conf. C = 0.01%/1000 hrs. 90% conf. D = 0.001%/1000 hrs. 90% conf. T = T Level Z = Non-ER	Qualification Level 0 = N/A 9 = SRC9000	Termination Finish H = Solder Plated 0 = Fused Solder Plated 8 = Hot Solder Dipped 9 = Gold Plated 7 = Matte Sn (COTS-Plus only)	Surge Test Option 00 = None 23 = 10 Cycles, +25°C 24 = 10 Cycles, -55°C & +85°C 45 = 10 cycles, -55°C & +85°C before Weibull

CWR09 P/N CROSS REFERENCE:

CWR09	D	^	686	*	@	+	□
Type	Voltage Code C = 4Vdc D = 6Vdc F = 10Vdc H = 15Vdc J = 20Vdc K = 25Vdc M = 35Vdc N = 50Vdc	Termination Finish H = Solder Plated 0 = Solder Fused C = Hot Solder Dipped B = Gold Plated	Capacitance Code pF code: 1st two digits represent significant figures 3rd digit represents multiplier (number of zeros to follow)	Capacitance Tolerance M = ±20% K = ±10% J = ±5%	Reliability Grade Weibull: B = 0.1%/1000 hrs. 90% conf. C = 0.01%/1000 hrs. 90% conf. D = 0.001%/1000 hrs. 90% conf. T = T Level A = Non-ER	Surge Test Option A = 10 cycles, +25°C B = 10 cycles, -55°C & +85°C C = 10 cycles, -55°C & +85°C before Weibull If blank, None required	Packaging Bulk = Standard T&R = 7" T&R W = Waffle

SPACE LEVEL OPTIONS TO SRC9000*:

TAZ	H	686	*	006	C	□	L	@	9	^	++
Type	Case Size	Capacitance Code pF code: 1st two digits represent significant figures 3rd digit represents multiplier (number of zeros to follow)	Capacitance Tolerance M = ±20% K = ±10% J = ±5%	Voltage Code 004 = 4Vdc 006 = 6Vdc 010 = 10Vdc 015 = 15Vdc 020 = 20Vdc 025 = 25Vdc 035 = 35Vdc 050 = 50Vdc	Standard or Low ESR Range C = Std ESR L = Low ESR	Packaging B = Bulk R = 7" T&R S = 13" T&R W = Waffle	Inspection Level L = Group A	Reliability Grade Weibull: B = 0.1%/1000 hrs. 90% conf. C = 0.01%/1000 hrs. 90% conf. D = 0.001%/1000 hrs. 90% conf.	Qualification Level 9 = SRC9000	Termination Finish H = Solder Plated 0 = Fused Solder Plated 8 = Hot Solder Dipped 9 = Gold Plated	Surge Test Option 00 = 10 Cycles, -55°C & +85°C 45 = 10 cycles, -55°C & +85°C before Weibull

*Contact factory for AVX SRC9000 Space Level SCD details.

Capacitance		Rated Voltage DC (V _n) at 85°C							
µF	Code	4V (C)	6V (D)	10V (F)	15V (H)	20V (J)	25V (K)	35V (M)	50V (N)
0.10	104								A
0.15	154								A
0.22	224								B
0.33	334	R		R			A		B
0.47	474			R		A		B	C
0.68	684				A	B	B	C	D
1.0	105				A/R	B	C	D	E
1.5	155		A		B	C	D	E	F
2.2	225	A/R		B	C	D	E		F
3.3	335		B		D	E		F	G
4.7	475	B	C	C	D	E	F	G	H
6.8	685	C	D	D	E			H	
10	106	D	E	E	F	F			
15	156	E	F	F	G	G	H		
22	226		F		G	H			
33	336	F		G	H				
47	476		G						
68	686	G	H						
100	107	H							
150	157								
220	227								

* Z, B Reliability Levels only available.

TAZ Series

CWR19 - MIL-PRF-55365/11



An extended range of capacitor ratings beyond CWR09 that is fully qualified to MIL-PRF-55365/11, this series represents the most flexible of surface mount form factors, offering nine case sizes (the original A through H of CWR09) and adds the new X case size.

The molded body / compliant termination construction ensures no TCE mismatch with any substrate. This construction is compatible with a wide range of SMT board assembly processes including wave or reflow solder, conductive epoxy or compression bonding techniques. The parts also carry full polarity and capacitance / voltage marking.

The four smaller cases are characterized by their low profile construction, with the A case being the world's smallest molded military tantalum chip.

The series is qualified to MIL-PRF-55365 Weibull "B", "C", "D" and "T" levels, with all surge options ("A", "B" & "C") available.

For Space Level applications, AVX SRC 9000 qualification is recommended (see ratings table for part number availability).

There are four termination finishes available: solder plated, fused solder plated, hot solder dipped and gold plated (these are "H", "K", "C" and "B" termination, respectively, per MIL-PRF-55365). In addition, the molding compound has been selected to meet the requirements of UL94V-0 (Flame Retardancy) and outgassing requirements of NASA SP-R-0022A.

Check for up-to-date CV Tables at <http://www.avx.com/docs/catalogs/taz.pdf>

HOW TO ORDER

COTS-PLUS & MIL QPL (CWR19):

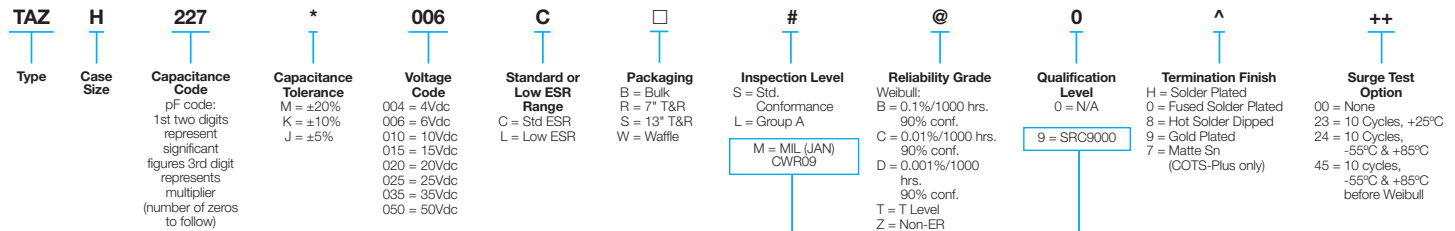

CWR09 P/N CROSS REFERENCE:

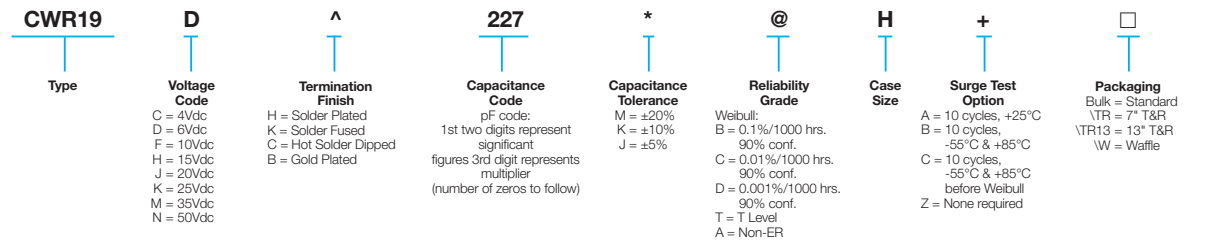

SPACE LEVEL OPTIONS TO SRC9000*:

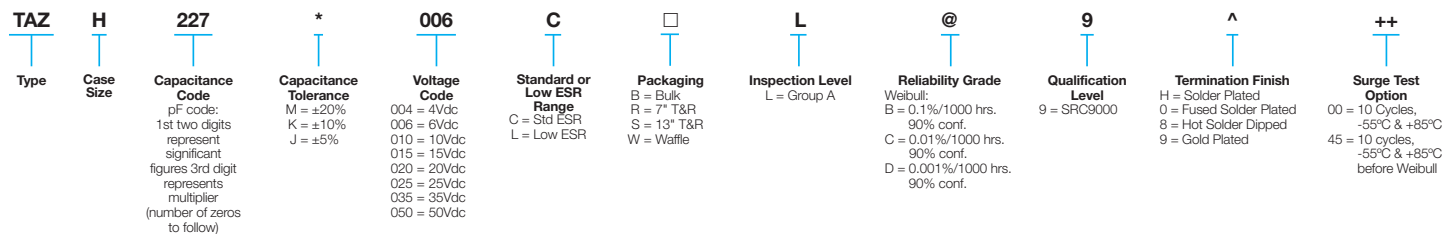

*Contact factory for AVX SRC9000 Space Level SCD details.

Capacitance		Rated voltage DC (V _R) at 85°C						
µF	Code	4V (C)	6V (D)	10V (F)	15V (H)	20V (J)	25V (K)	35V (M)
0.10	104							
0.15	154							
0.22	224							
0.33	334							
0.47	474						A	A
0.68	684							
1.0	105				A	A	B	
1.5	155				A	B		
2.2	225			A	A	B	D	
3.3	335	A	A	A	B	D	E	
4.7	475	A	A	B/C	B/C/D	E		
6.8	685	A	B	B/C/D	D/E	E	F	G
10	106	B	B	B/C/D/E	D/E	E/F	G	H
15	156	B	B/D/E	D/E	E/F	F	G	
22	226	B/D	D/E	E	F	G	G/H	
33	336	D/E	E	F	F/G	H	H	
47	476	E	F	F/G	G/H	H/X		
68	686	E	F/G	G	G/H			
100	107	F	G	G/H	H			
150	157	G	G	H/X				
220	227	H	H	H				
330	337	H	H					

TAZ Series

CWR29 - MIL-PRF-55365/11 Established Reliability, COTS-Plus & Space Level



A low ESR version of CWR09 and CWR19 that is fully qualified to MIL-PRF-55365/11, the CWR29 series represents the most flexible of surface mount form factors and the optimum power handling for all filtering applications. It is offered in nine case sizes (the original A through H of CWR09 and adding the new X case size).

The molded body / compliant termination construction ensures no TCE mismatch with any substrate. This construction is compatible with a wide range of SMT board assembly processes including wave or reflow solder, conductive epoxy or compression bonding techniques. The parts also carry full polarity and capacitance / voltage marking.

The five smaller cases are characterized by their low profile construction, with

the A case being the world's smallest molded military tantalum chip.

The series is qualified to MIL-PRF-55365 Weibull "B", "C", "D" and "T" levels, with all surge options ("A", "B" & "C") available.

For Space Level applications, AVX SRC 9000 qualification is recommended (see ratings table for part number availability).

There are four termination finishes available: solder plated, fused solder plated, hot solder dipped and gold plated (these are "H", "K", "C" and "B" termination, respectively, per MIL-PRF-55365). In addition, the molding compound has been selected to meet the requirements of UL94V-0 (Flame Retardancy) and outgassing requirements of NASA SP-R-0022A.

Check for up-to-date CV Tables at <http://www.avx.com/docs/catalogs/taz.pdf>

HOW TO ORDER

COTS-PLUS & MIL QPL (CWR29):

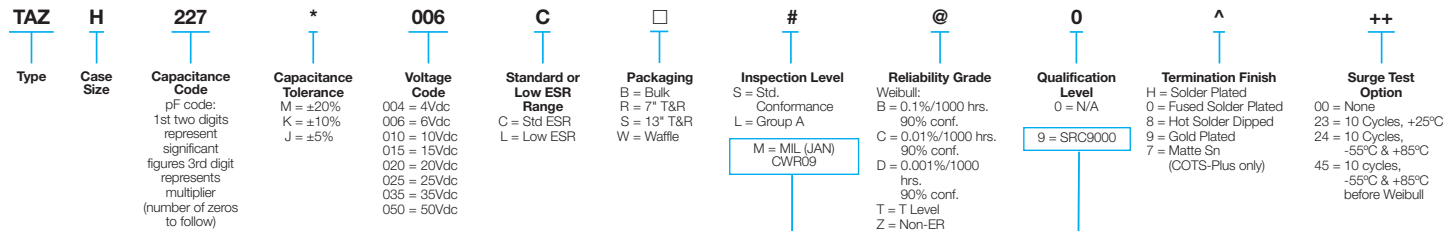

CWR09 P/N CROSS REFERENCE:

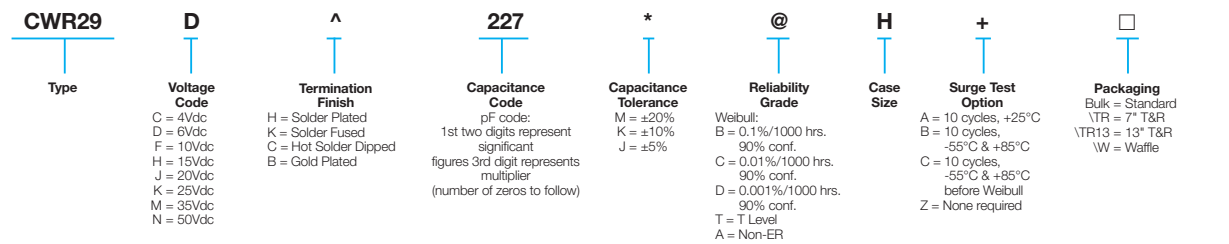

SPACE LEVEL OPTIONS TO SRC9000*:

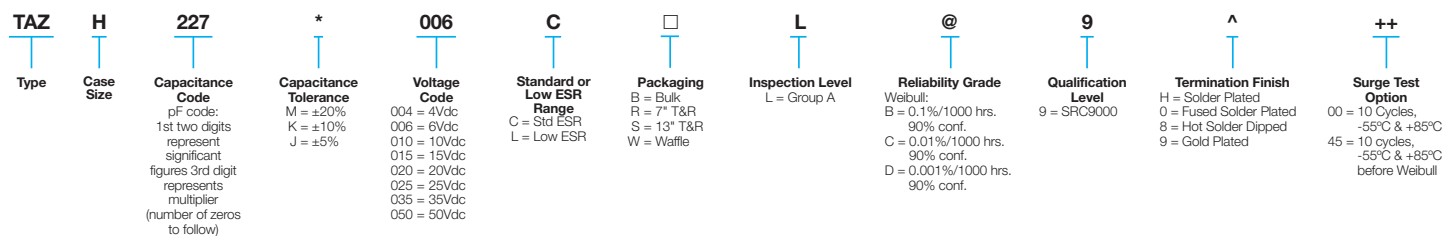

*Contact factory for AVX SRC9000 Space Level SCD details.

Capacitance		Rated voltage DC (V _R) at 85°C							
µF	Code	4V (C)	6V (D)	10V (F)	15V (H)	20V (J)	25V (K)	35V (M)	50V (N)
0.10	104								A
0.15	154								A
0.22	224							A	B
0.33	334						A	A	B
0.47	474					A	A	B	C
0.68	684					A/B	B	C	D
1.0	105			A	A	A/B	B/C	D	E
1.5	155		A		A/B	B/C	D	E	F
2.2	225	A		A/B	A/C	B/D	D/E		F
3.3	335	A	A/B	A/C	B/D	D/E	E	F	G
4.7	475	A/B	A/C	B/C/D	B/C/D/E	E	F	G	H
6.8	685	A/C	B/D	B/C/D/E	D/E	E/F	F/G	G/H	
10	106	B/D	B/E	B/C/D/E	D/E/F	E/F	G	H	
15	156	B/E	B/D/E	D/E/F	E/F	F/G	G/H		
22	226	B/D	D/E/F	E	F/G	G/H	G/H		
33	336	D/E/F	E	F/G	F/G/H	H	H		
47	476	E	F/G	F/G/H	G/H	H/X			
68	686	E/G	F/G/H	G	G/H				
100	107	F/H	G	G/H	H				
150	157	G	G	H/X					
220	227	H	H	H					
330	337	H	H						

TAZ Series

Extended Range – 63V COTS-Plus



The TAZ part has fully molded, compliant leadframe construction designed for use in applications utilizing solder (Reflow, Wave or Vapor Phase), conductive adhesive or thermal compression bonding techniques. Each chip is marked with polarity, capacitance code and rated voltage. The 63 volt rated parts are ideal for avionic output power supply filtering. Many systems utilize a 28 volt bus and this new rating

surpasses the recommended 50% derating for optimized reliability in these applications. The series has Weibull “B” level and all surge options (“A”, “B” & “C”) available. There are four termination finishes available: solder plated, fused solder plated, hot solder dipped and gold plated (These are “H”, “K”, “C” and “B” termination respectively per MIL-PRF-55365).

Check for up-to-date CV Tables at <http://www.avx.com/docs/catalogs/taz.pdf>

HOW TO ORDER

TAZ	H	685	*	063	C	□	#	@	0	^	++
Type	Case Size	Capacitance Code pF code: 1st two digits represent significant figures 3rd digit represents multiplier (number of zeros to follow)	Capacitance Tolerance M = ±20% K = ±10% J = ±5%	Voltage Code 63 = 63Vdc	Standard or Low ESR Range C = Std ESR	Packaging B = Bulk R = 7" T&R S = 13" T&R W = Waffle	Inspection Level L = Group A S = Standard Conformance	Reliability Grade Weibull: B = 0.1%/1000 hrs. 90% conf. Z = Non - ER	Qualification Level 0 = NA	Termination Finish H = Solder Plated 0 = Fused Solder Plated 7 = Matte Sn 8 = Hot Solder Dipped 9 = Gold Plated	Surge Test Option 00 = None 23 = 10 Cycles, +25°C 24 = 10 Cycles, -55°C & +85°C 45 = 10 cycles, -55°C & +85°C before Weibull

*Contact factory for AVX SRC9000 Space Level SCD details.

CAPACITANCE AND RATED VOLTAGE, V_R (VOLTAGE CODE) RANGE (LETTER DENOTES CASE SIZE)

Capacitance		Rated voltage DC (V_R) at 85°C
µF	Code	63V
0.68	684	D
1.0	105	E
1.5	155	F
2.2	225	F
3.3	335	G
4.7	475	H
6.8	685	H

TCP Series

Low ESR Tantalum Modules



TCP Series tantalum modules represents the highest packing density for high capacitance / voltage available in surface mount tantalum.

These modules feature stacked assemblies of CWR29 capacitors which provide ultra low ESR and utilize established reliability capacitors (Weibull Grade voltage conditioning) in accordance with MIL-PRF-55365. They can also be supplied with SRC9000 Space Level components.

The stacked construction of fully molded capacitors is compatible with a wide range of SMT board assembly processes including wave or reflow solder or conductive epoxy.

There are two termination finishes available: hot solder dipped ("C") and gold plated ("B").

The molding compound has been selected to meet the requirements of UL94V-0 and outgassing requirements of NASA SP-R-0022A.

 Check for up-to-date CV Tables at <http://www.avx.com/docs/catalogs/tcp.pdf>

HOW TO ORDER

TC	2H	945	K	050	L	R	#	@	0	^	++
Type	Case Size	Capacitance Code	Capacitance Tolerance	Voltage Code	Standard or Low ESR Range	Packaging	Inspection Level	Reliability Grade	Qualification Level	Termination Finish	Surge Test Option
		pF code: 1st two digits represent significant figures 3rd digit represents multiplier (number of zeros to follow)	M = ±20% K = ±10% J = ±5%	006 = 6Vdc 010 = 10Vdc 015 = 15Vdc 020 = 20Vdc 025 = 25Vdc 035 = 35Vdc 050 = 50Vdc	L = Low ESR	B = Bulk R = 7* T&R	S = Std. Conformance L = Group A D = DSCC DWG	Weibull: B = 0.1%/1000 hrs. 90% conf. C = 0.01%/1000 hrs. 90% conf. D = 0.001%/1000 hrs. 90% conf. Z = Non-ER	0 = N/A 9 = SRC9000	8 = Hot Solder Dipped 9 = Gold Plated	00 = None 23 = 10 Cycles, +25°C 24 = 10 Cycles, -55°C & +85°C 45 = 10 cycles, -55°C & +85°C before Weibull

Capacitance		Rated voltage DC (V _R) to 85°C						
µF	Code	6V	10V	15V	20V	25V	35V	50V
9.4	945							2H (200)
18.8	196							4H (100)
20	206						2H (200)	
28.2	286							6H (67)
40	406						4H (100)	
60	606						6H (67)	
66	666					2H (85)		
94	946				2H (75)			
132	137					4H (43)		
188	197				4H (38)			
198	207					6H (28)		
200	207			2H (63)				
282	287				6H (25)			
400	407			4H (31)				
440	447		2H (50)					
600	607			6H (21)				
660	667	2H (50)						
880	887		4H (25)					
1,320	138	4H (25)	6H (17)					
1,980	208	6H (17)						

TBJ Series

CWR11 - MIL-PRF-55365/8 Established Reliability, COTS-Plus & Space Level



Fully qualified to MIL-PRF-55365/8, the CWR11 is the military version of EIA-535BAAC, with four case sizes designed for maximum packaging efficiency on 8mm & 12mm tape for high volume production (ensuring no TCE mismatch with any substrate). This construction is compatible with a wide range of SMT board assembly processes including wave or reflow solder, conductive epoxy or compression bonding techniques. The part also carries full polarity, capacitance / voltage and JAN brand marking.

The series is qualified to MIL-PRF-55365 Weibull "B", "C", "D" and "T" levels, with all surge options ("A", "B" & "C") available.

For Space Level applications, AVX SRC9000 qualification is recommended (see ratings table for part number availability).

There are four termination finishes available: solder plated, fused solder plated, hot solder dipped and gold plated (these are "H", "K", "C" and "B" termination, respectively, per MIL-PRF-55365).

The molding compound has been selected to meet the requirements of UL94V-0 (Flame Retardancy) and outgassing requirements of NASA SP-R-0022A.

Check for up-to-date CV Tables at <http://www.avx.com/docs/catalogs/tbj.pdf>

HOW TO ORDER

COTS-PLUS & MIL QPL (CWR11):

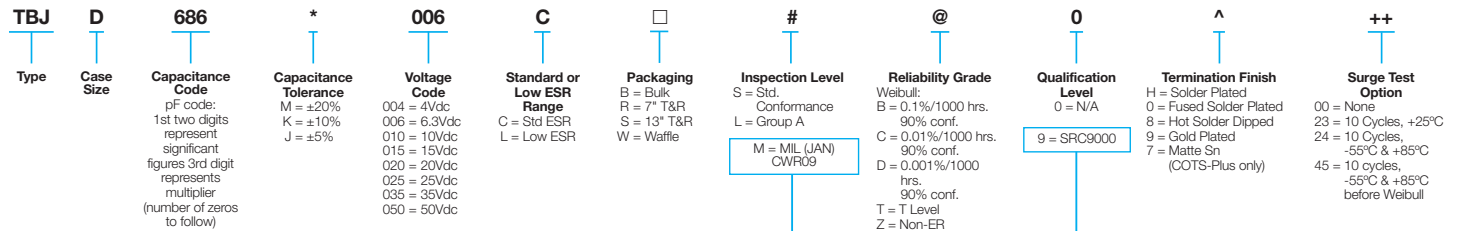

CWR09 P/N CROSS REFERENCE:

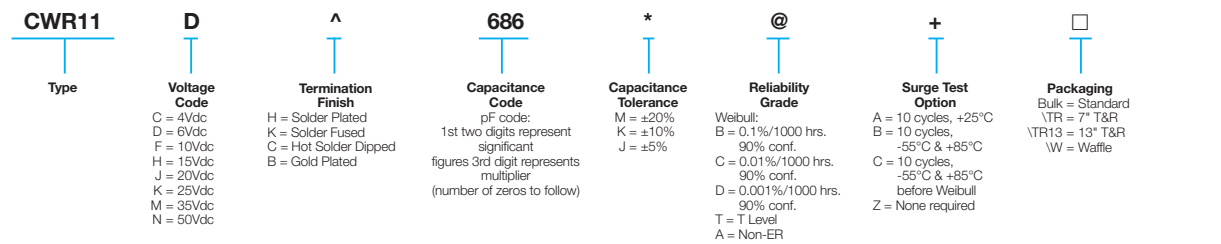

SPACE LEVEL OPTIONS TO SRC9000*:

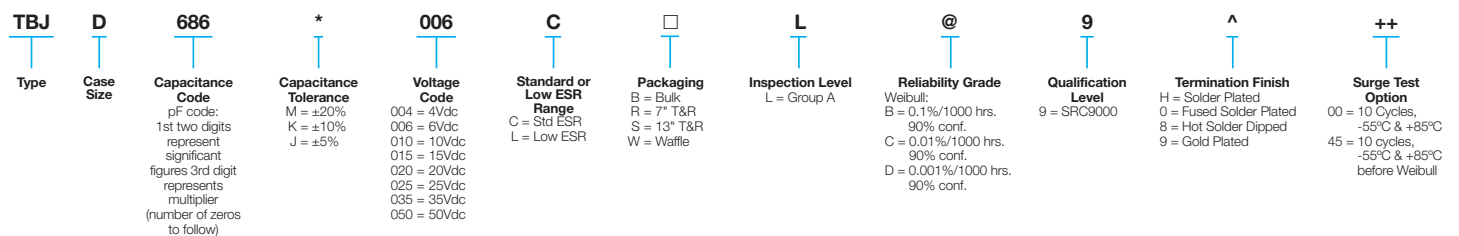

*Contact factory for AVX SRC9000 Space Level SCD details.

Capacitance		Rated voltage DC (V _R) to 85°C							
µF	Code	4V (C)	6V (D)	10V (F)	15V (H)	20V (J)	25V (K)	35V (M)	50V (N)
0.10	104							A	A
0.15	154							A	B
0.22	224							A	B
0.33	334						A	A	B
0.47	474					A	A	B	C
0.68	684				A	A	B	B	C
1.0	105			A	A	A	B	B	C
1.5	155		A	A	A	B	B	B	D
2.2	225	A	A	A	B	B	C	C	D
3.3	335		A	B	B	B	C	C	D
4.7	475	A	B	B	B	C	C	D	D
6.8	685	B	B	B		C	D	D	
10	106	B	B		C		D		
15	156	B	C			D	D		
22	226		C			D			
33	336	C		D	D				
47	476		D	D					
68	686	D	D						
100	107	D							
150	157								
220	227								
330	337								

TBJ Series

COTS-Plus – DSCC Dwgs 07016 & 95158 Weibull Grade & Space Level

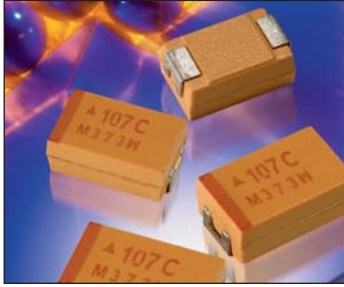

TBJ COTS-Plus series, based on the CWR11 form factor, is a high reliability series encompassing the current range of EIA Low ESR ratings. Qualifications include DSCC 95158 and DSCC 07016, the latter having the widest range of case sizes, capacitance / voltage ratings and also offering Weibull Grade "B" and "C" reliability and all MIL-PRF-55365 surge test options ("A", "B" & "C").

For Space Level applications, AVX SRC 9000 qualification is recommended (see ratings table for part number availability).

There are four termination finishes available: solder plated, fused solder plated, hot solder dipped and gold plated (these correspond to "H", "K", "C" and "B" termination, respectively, per MIL-PRF-55365).

The molding compound has been selected to meet the requirements of UL94V-0 (Flame Retardancy) and outgassing requirements of NASA SP-R-0022A.

Check for up-to-date CV Tables at <http://www.avx.com/docs/catalogs/tbj.pdf>

HOW TO ORDER

COTS-PLUS & DSCC DWG (95158 & 07016):

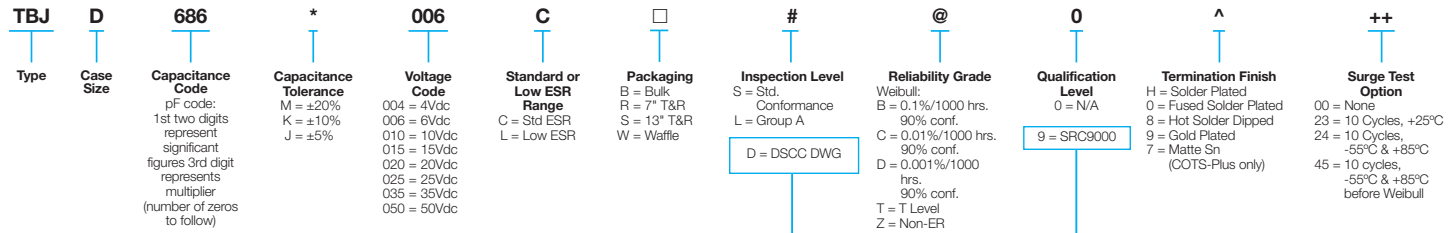

DSCC DWG P/N CROSS REFERENCE:

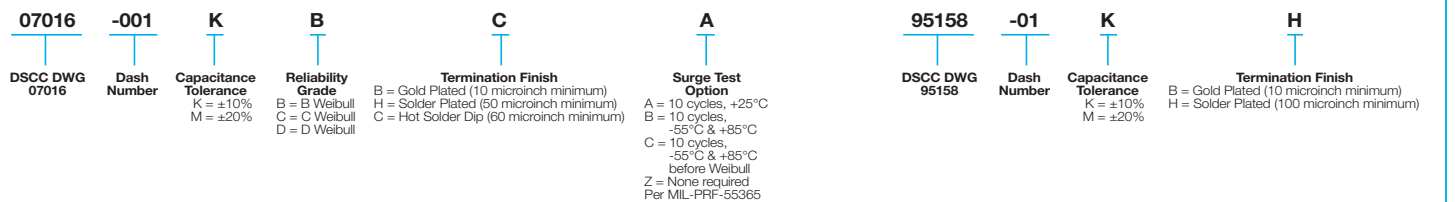

SPACE LEVEL OPTIONS TO SRC9000*:

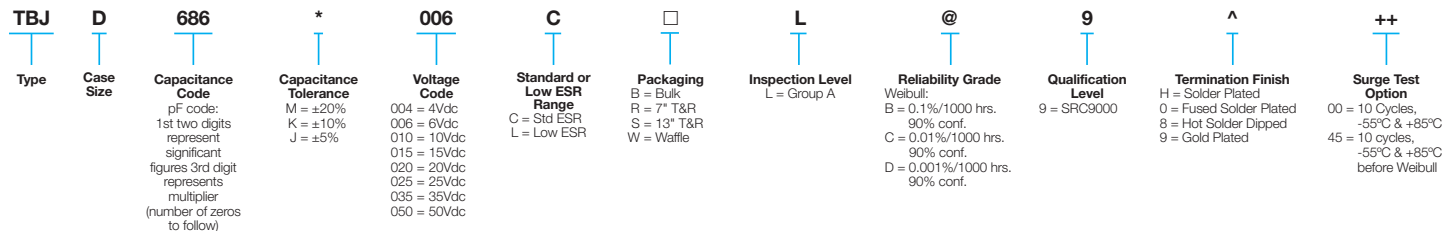

*Contact factory for AVX SRC9000 Space Level SCD details.

Capacitance		Rated Voltage DC (V _R) to 85°C							
µF	Code	4V (G)	6V (J)	10V (A)	16V (C)	20V (D)	25V (E)	35V (V)	50V (T)
0.15	154								A(15000)
0.22	224								A(18000)
0.47	474								A(9500)/B(9500)
0.68	684								A(7900)
1.0	105								A(6600)/B(7000)
1.5	155								C(2000)/D(1500)
2.2	225								D(1200)
3.3	335								D(800)
4.7	475								D(300)
6.8	685								E(300)
10	106								D(300,600)
15	156								E(400)
22	226								
33	336								
47	476								
68	686								
100	107								
150	157								
220	227								
330	337								
470	477								
1000	108								

NOTE: EIA standards for Low ESR solid tantalum capacitors allow an ESR movement of 1.25 times initial limit post mounting.

TBM Multianode

Tantalum Ultra Low ESR COTS-Plus Weibull Grade & Space Level

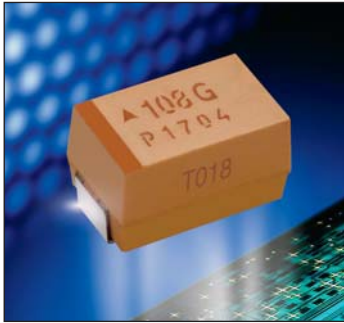

TBM COTS-Plus series uses an internal multi-anode design to achieve ultra-low ESR which improves performance in high ripple power applications.

TBM is available with Weibull Grade "B" reliability and all MIL-PRF-55365 surge test options ("A", "B" & "C").

There are four termination finishes available: solder

plated, fused solder plated, hot solder dipped and gold plated (these correspond to "H", "K", "C" and "B" termination, respectively, per MIL-PRF-55365).

The molding compound has been selected to meet the requirements of UL94V-0 (Flame Retardancy) and outgassing requirements of NASA SP-R-0022A.

Check for up-to-date CV Tables at <http://www.avx.com/docs/catalogs/tbm.pdf>

HOW TO ORDER

COTS-PLUS:

TBM	E	477	*	006	C	□	#	@	0	^	++
Type	Case Size	Capacitance Code	Capacitance Tolerance	Voltage Code	Standard or Low ESR Range	Packaging	Inspection Level	Reliability Grade	Qualification Level	Termination Finish	Surge Test Option
		pF code: 1st two digits represent significant figures 3rd digit represents multiplier (number of zeros to follow)	M = ±20% K = ±10% J = ±5%	002 = 2.5Vdc 004 = 4Vdc 006 = 6.3Vdc 010 = 10Vdc 016 = 15Vdc 020 = 20Vdc 025 = 25Vdc 035 = 35Vdc	C = Std ESR L = Low ESR	B = Bulk R = 7" T&R S = 13" T&R W = Waffle	S = Std. Conformance L = Group A D = DSCC DWG (Pending)	Weibull: B = 0.1%/1000 hrs. 90% conf. C = 0.01%/1000 hrs. 90% conf. D = 0.001%/1000 hrs. 90% conf. T = T Level Z = Non-ER	0 = N/A 9 = SRC9000	H = Solder Plated 0 = Fused Solder Plated 8 = Hot Solder Dipped 9 = Gold Plated 7 = Matte Sn (COTS-Plus only)	00 = None 23 = 10 Cycles, +25°C 24 = 10 Cycles, -55°C & +85°C 45 = 10 cycles, -55°C & +85°C before Weibull

SPACE LEVEL OPTIONS TO SRC9000*:

TBM	H	227	*	006	C	□	L	@	9	^	++
Type	Case Size	Capacitance Code	Capacitance Tolerance	Voltage Code	Standard or Low ESR Range	Packaging	Inspection Level	Reliability Grade	Qualification Level	Termination Finish	Surge Test Option
		pF code: 1st two digits represent significant figures 3rd digit represents multiplier (number of zeros to follow)	M = ±20% K = ±10% J = ±5%	002 = 2.5Vdc 004 = 4Vdc 006 = 6.3Vdc 010 = 10Vdc 016 = 15Vdc 020 = 20Vdc 025 = 25Vdc 035 = 35Vdc	C = Std ESR L = Low ESR	B = Bulk R = 7" T&R S = 13" T&R W = Waffle	L = Group A	Weibull: B = 0.1%/1000 hrs. 90% conf. C = 0.01%/1000 hrs. 90% conf. D = 0.001%/1000 hrs. 90% conf.	9 = SRC9000	H = Solder Plated 0 = Fused Solder Plated 8 = Hot Solder Dipped 9 = Gold Plated	00 = 10 Cycles, -55°C & +85°C 45 = 10 cycles, -55°C & +85°C before Weibull

*Qualifications Pending

Capacitance		Rated Voltage DC (V _R) to 85°C							
µF	Code	2.5V (e)	4V (G)	6V (J)	10V (A)	15V (C)	20V (D)	25V (E)	35V (V)
10	106								
15	156								
22	226								E(60)
33	336								E(50)
47	476								E(55)
68	686							E(45)	
100	107						E(35)		
150	157					E(30)			
220	227					E(25)			
330	337				E(23)				
470	477			E(18)	E(23)				
680	687		E(18)	E(18), V(23)					
1000	108		E(18), V(18)						
1500	158	E(12)	E(15)						

NOTE: EIA standards for Low ESR solid tantalum capacitors allow an ESR movement of 1.25 times initial limit post mounting.

TBW Series

Tantalum Fused DSCC Dwg 04053 COTS-Plus Weibull Grade & Space Level



TBW Fused Tantalum Capacitors offer protection from possible damaging short circuit failure modes. This is accomplished with an internal fuse in series with the capacitor. See the photograph on the right. The AVX fused tantalum offers lower ESR limits than competitive fused tantalum capacitors, and is available with Weibull and surge testing per MIL-PRF-55365.

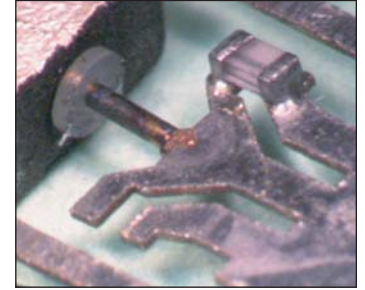

Anode, fuse and leadframe assembly



Check for up-to-date CV Tables at <http://www.avx.com/docs/catalogs/tbw.pdf>

HOW TO ORDER

COTS-PLUS & DSCC DWG (04053):

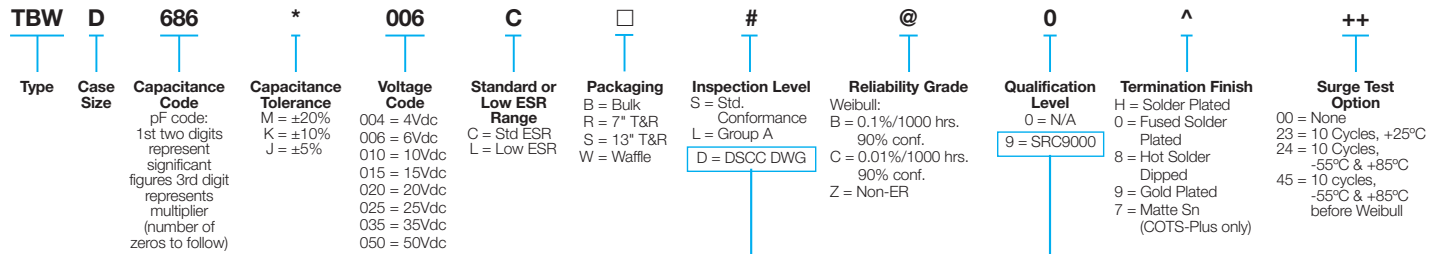

DSCC DWG P/N CROSS REFERENCE:



NOTE: DSCC DWG 04053 specifies 20% capacitance tolerance and solder plated termination options only. For 10% capacitance tolerance, solder fused finish, Weibull grading and MIL surge options, order using AVX part number above.

SPACE LEVEL OPTIONS TO SRC9000*:

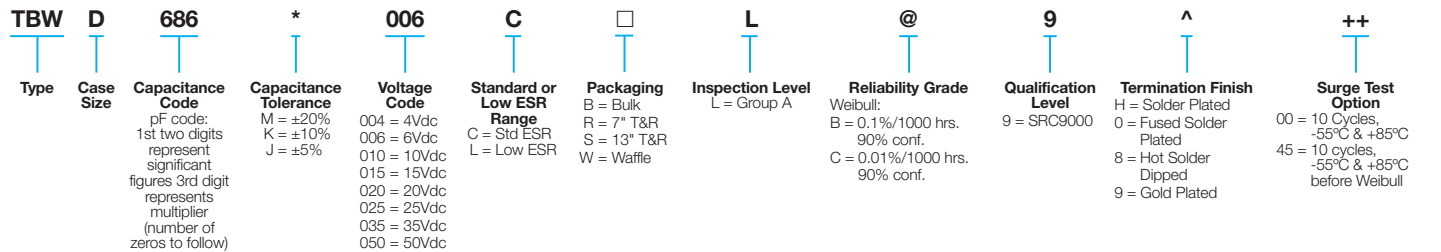

*Qualifications Pending

Capacitance µF	Rated Voltage DC (V _R) to 85°C							
	4	6	10	16	20	25	35	50
0.47								C
0.68								C
1								C
1.5			-	-	-	-	C	C
2.2			-	-	-	C	C	D
3.3			-	-	-	C	C	D
4.7			-	-	C	C	D	D
6.8			-	-	C	C	D	
10			-	C	C	C/D	E	E(20%)
15		C	C	C	D	D	D/E	-
22		C	C	C/D	D	D/E	E	-
33		C	C/D	C/D	D	-	-	-
47		C/D	C/D	D/E	E	-	-	-
68	C	C/D	D	E	-	-	-	-
100	C	D/E	D/E	-	-	-	-	-
150	D	D	D/E	-	-	-	-	-
220	D	D/E	E	-	-	-	-	-
330	E	E	-	-	-	-	-	-
470	E	-	-	-	-	-	-	-

TBC Series

CWR15 Military Approved Microchip



AVX announces the world's smallest military approved tantalum chip capacitors. The CWR15 offers 0603, 0805 and 1206 case sizes in capacitance voltage combinations previously only available in much larger packages. The revolutionary AVX TACmicrochip® technology offers designers significant opportunity to downsize circuits for military and aerospace applications. The product is manufactured in the AVX Tantalum high reliability facility in Biddeford, Maine which is also home to the CWR09, CWR11, CWR19 and CWR29 product lines.

Check for up-to-date CV Tables at <http://www.avx.com/docs/catalogs/tbc.pdf>

HOW TO ORDER

COTS-PLUS & MIL QPL (CWR29):

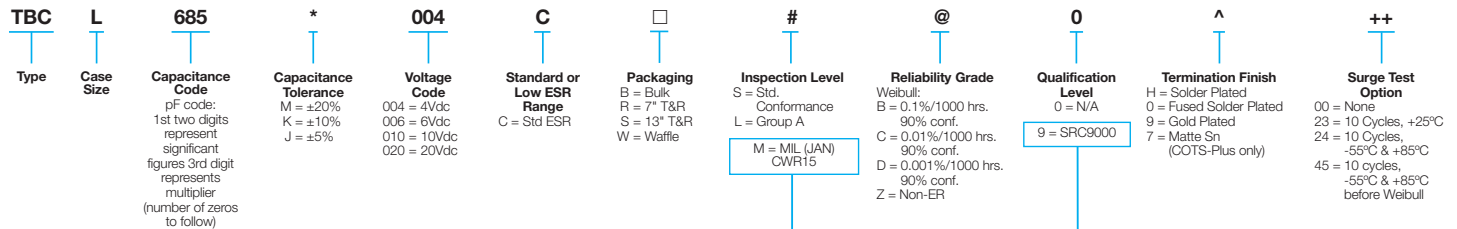

CWR15 P/N CROSS REFERENCE:

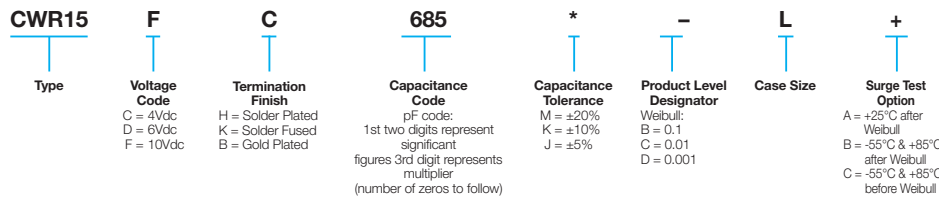

SPACE LEVEL OPTIONS TO SRC9000*:

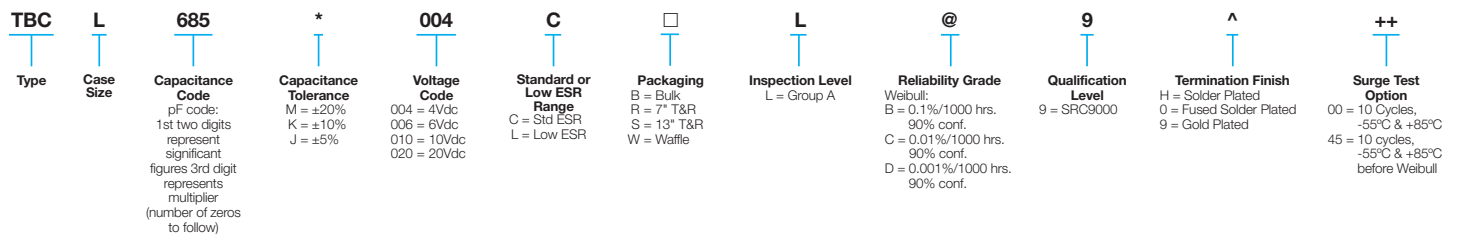

*Contact factory for AVX SRC9000 Space Level SCD details.

Capacitance		Voltage Rating DC (V _R) at 85°C				
µF	Code	4V (C)	6V (D)	10V (F)	15V (H)	20V (J)
0.33	334					
0.47	474					L
0.68	684					
1.0	105					
1.5	155					
2.2	225					
3.3	335		L	R		
4.7	475		L	R		
6.8	685	L	R	R		
10	106	R	R	R		
15	156	R	R	A		
22	226	R	A			
33	336	R	A			
47	476		A			
68	686	A				

Further extensions of the CWR15 product are planned for later in 2009. A new case size will be added, and the voltage range will be extended to 20 volts. Ratings of 100 µF at 4 volts to 10 µF at 20 volts will be included in this extension of the product line.

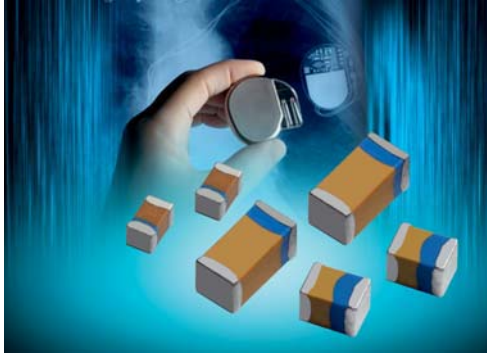

TBC COTS-Plus series extends the range of CWR15. TBC is available with Weibull grade “B” reliability and all MIL-PRF-55365 surge test options (“A”, “B” & “C”).

For Space Level applications, AVX SRC9000 ratings are available as shown in the rating table.

There are four termination finishes available: solder plated, fused solder plated, hot solder dipped and gold plated (these correspond to “H”, “K”, “C” and “B” termination, respectively, per MIL-PRF 55365).

Check for up-to-date CV Tables at
<http://www.avx.com/docs/catalogs/tbc.pdf>

HOW TO ORDER COTS-PLUS:

TBC	L	685	*	004	C	□	#	@	0	^	++
Type	Case Size	Capacitance Code	Capacitance Tolerance	Voltage Code	Standard or Low ESR Range	Packaging	Inspection Level	Reliability Grade	Qualification Level	Termination Finish	Surge Test Option
		pF code: 1st two digits represent significant figures 3rd digit represents multiplier (number of zeros to follow)	M = ±20% K = ±10% J = ±5%	004 = 4Vdc 006 = 6Vdc 010 = 10Vdc 020 = 20Vdc	C = Std ESR	B = Bulk R = 7" T&R S = 13" T&R W = Waffle	S = Std. Conformance L = Group A	Weibull: B = 0.1%/1000 hrs. 90% conf. C = 0.01%/1000 hrs. 90% conf. D = 0.001%/1000 hrs. 90% conf. Z = Non-ER None required	0 = N/A 9 = SRC9000	H = Solder Plated 0 = Fused Solder Plated 9 = Gold Plated 7 = Matte Sn (COTS-Plus only)	00 = None 23 = 10 Cycles, +25°C 24 = 10 Cycles, -55°C & +85°C 45 = 10 cycles, -55°C & +85°C before Weibull

SPACE LEVEL OPTIONS TO SRC9000*:

TBC	L	685	*	004	C	□	L	@	9	^	++
Type	Case Size	Capacitance Code	Capacitance Tolerance	Voltage Code	Standard or Low ESR Range	Packaging	Inspection Level	Reliability Grade	Qualification Level	Termination Finish	Surge Test Option
		pF code: 1st two digits represent significant figures 3rd digit represents multiplier (number of zeros to follow)	M = ±20% K = ±10% J = ±5%	004 = 4Vdc 006 = 6Vdc 010 = 10Vdc 020 = 20Vdc	C = Std ESR L = Low ESR	B = Bulk R = 7" T&R S = 13" T&R W = Waffle	L = Group A	Weibull: B = 0.1%/1000 hrs. 90% conf. C = 0.01%/1000 hrs. 90% conf. D = 0.001%/1000 hrs. 90% conf.	9 = SRC9000	H = Solder Plated 0 = Fused Solder Plated 9 = Gold Plated	00 = 10 Cycles, -55°C & +85°C 45 = 10 cycles, -55°C & +85°C before Weibull

*Contact factory for AVX SRC9000 Space Level SCD details.

Capacitance		Voltage Rating DC (V _R) at 85°C						
μF	Code	3V	4V	6V	10V	16V	20V	25V
0.33	334				K / L	L	L	L
0.47	474				L	L		
0.68	684				L	L		
1.0	105			K	L	L		
1.5	155				L	L		
2.2	225				L	L		
3.3	335				L / R		R	
4.7	475				L / R		R	
6.8	685			L	R			
10	106		R	R	R	R		
15	156	R	R		A			
22	226		R	R / A				
33	336	R	R	A				
47	476			A				
68	686		A					

NBS Series

COTS-Plus

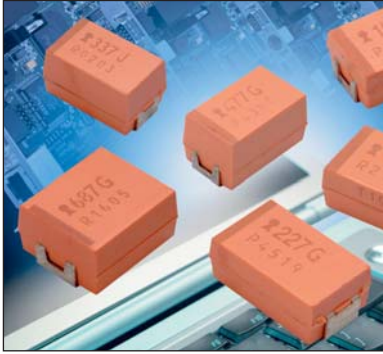

NBS, Niobium Oxide COTS-Plus Capacitors offer a non-burn solution for Military and Space applications. Niobium Oxide COTS-Plus Capacitors may be specified with failure rate grading to Weibull “B” or “C” and surge current tested in accordance with Mil-PRF-55365 options A or B.

Check for up-to-date CV Tables at <http://www.avx.com/docs/catalogs/nbs.pdf>

HOW TO ORDER

NBS	E	227	*	006	C	□	#	@	0	^	++
Type	Case Size	Capacitance Code pF code: 1st two digits represent significant figures 3rd digit represents multiplier (number of zeros to follow)	Capacitance Tolerance M = ±20%	Voltage Code 001 = 1.8Vdc 002 = 2.5Vdc 004 = 4Vdc 006 = 6.3Vdc	Standard or Low ESR Range L = Low ESR	Packaging B = Bulk R = 7" T&R S = 13" T&R W = Waffle	Inspection Level S = Std. Conformance L = Group A D = DSCC DWG	Reliability Grade Weibull: B = 0.1%/1000 hrs. 90% conf. C = 0.01%/1000 hrs. 90% conf.	Qualification Level 0 = N/A	Termination Finish H = Solder Plated 0 = Fused Solder Plated 8 = Hot Solder Dipped 9 = Gold Plated 7 = Matte Sn (COTS-Plus only)	Surge Test Option 00 = None 23 = 10 Cycles, +25°C 24 = 10 Cycles, -55°C & +85°C 45 = 10 cycles, -55°C & +85°C before Weibull

Capacitance		Rated Voltage DC (V _R) to 85°C / 0.66 DC to 105°C / 0.5 DC to 125°C			
µF	Code	1.8V (x)	2.5V (e)	4.0V (G)	6.3V (J)
4.7	475				
6.8	685				
10	106				A(1000,2000)
15	156			A(1500)	B(600)
22	226		A(900)	B(600)	B(600)
33	336		B(600)*	B(600)	B(600)/C(500)
47	476		B(500)	B(500)/C(300)	C(300)
68	686		C(200)	C(200)	C(75,200)
100	107	B(350)	C(150)	C(70,150)	C(150)/D(80,100)
150	157		C(65,150)	C(90,150)	D(50,70,100)
220	227	C(125)	C(80,125)	D(60,150)	D(60,100) E(80,100)
330	337		D(35,50,100)	D(55,100)/E(100)	E(80,100)
470	477		D(55,100)/E(100)	D(35,40,100) E(75,100)	V(75)
680	687		E(60)	V(75)	
1000	108		V(50)		
1500	158				

*Please Contact Manufacturer

NBM Multianode

OxiCap® Ultra Low ESR Capacitor COTS-Plus Weibull Grade

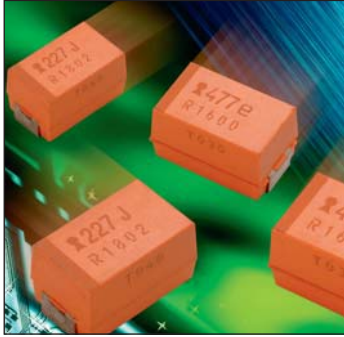

NBM OxiCap® capacitors are the COTS-Plus version of the popular NOM Low ESR multianode capacitor. Capacitors are available to Weibull failure rates B and C along with surge current testing per Mil-PRF-55365. Niobium oxide technology offers non-burn characteristics along with excellent reliability and reduced derating.

Check for up-to-date CV Tables at <http://www.avx.com/docs/catalogs/nbm.pdf>

HOW TO ORDER

NBM	E	227	*	006	C	□	#	@	0	^	++
Type	Case Size	Capacitance Code	Capacitance Tolerance	Voltage Code	Standard or Low ESR Range	Packaging	Inspection Level	Reliability Grade	Qualification Level	Termination Finish	Surge Test Option
		pF code: 1st two digits represent significant figures 3rd digit represents multiplier (number of zeros to follow)	M = ±20%	001 = 1.8Vdc 002 = 2.5Vdc 004 = 4Vdc 006 = 6.3Vdc	L = Low ESR	B = Bulk R = 7" T&R S = 13" T&R W = Waffle	S = Std. Conformance L = Group A D = DSCC DWG	Weibull: B = 0.1%/1000 hrs. 90% conf. C = 0.01%/1000 hrs. 90% conf.	0 = N/A	H = Solder Plated 0 = Fused Solder Plated 8 = Hot Solder Dipped 9 = Gold Plated 7 = Matte Sn (COTS-Plus only)	00 = None 23 = 10 Cycles, +25°C 24 = 10 Cycles, -55°C & +85°C 45 = 10 cycles, -55°C & +85°C before Weibull

Capacitance		Rated Voltage DC (V _R) to 85°C / 0.66 DC to 105°C / 0.5 DC to 125°C			
μF	Code	1.8V (x)	2.5V (e)	4.0V (G)	6.3V (J)
150	157				
220	227				E(40)
330	337			E(35)	E(23)
470	477		E(30)	E(23)	
680	687	E(23)	E(23)		
1000	108				

TWA Series

Wet Electrolytic Tantalum Capacitor

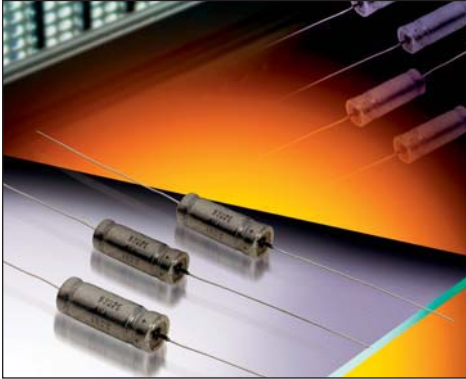

The TWA series is an axial leaded wet electrolytic tantalum capacitor and represents a new level of high CV (capacitance / voltage) previously unavailable in this technology. TWA incorporates a novel, very high capacitance cathode system that allows for higher CV designs, well beyond values specified in the Mil-PRF-39006 drawing. TWA products are listed in DSCC 93026 Rev. P, which includes new high capacitance / voltage ratings.

This design includes a welded tantalum can and header assembly that provides a hermetic seal to withstand the harsh shock and vibration requirements of 39006.

Customized capacitance and voltage packages are possible and welcomed. Contact the factory about design possibilities beyond those contained in this catalog.

[Check for up-to-date CV Tables at http://www.avx.com/docs/catalogs/twa.pdf](http://www.avx.com/docs/catalogs/twa.pdf)

HOW TO ORDER

TWA	D	227	*	35	<input type="checkbox"/>	<input type="checkbox"/>	S	Z	00	00
Type	Case Size	Capacitance Code pF code: 1st two digits represent significant figures 3rd digit represents multiplier (number of zeros to follow)	Capacitance Tolerance	Voltage Code	Insulation Sleeve C = Without Sleeve S = With Sleeve	Packaging B = Tray Pack	Qualification D = DSCC 93026 S = COTS-Plus	Reliability Z = Non-ER	Termination Finish 00 = Tin/Lead 90/10	Custom Test Options 00 = Standard

DSCC PART IDENTIFICATION NUMBER (PIN):

93026	-XX	*	<input type="checkbox"/>
Drawing Number	Dash Number	Capacitance Tolerance K = 10% M = ±20%	Insulation Sleeve C = Without Sleeve S = With Sleeve

VOLTAGE RATINGS (Operating Temperature -55°C to 125°C)

Voltage (DC)	85°C	25	30	50	60	75	100	125
Rated Voltage: (Ur)	85°C	25	30	50	60	75	100	125
Derated Voltage: (Uc)	125°C	15	20	30	40	50	65	85
Surge Voltage: (Us)	85°C	28.8	34.5	57.5	69	86.3	115	144

Capacitance		Voltage Rating DC (V _R) at 85°C						
µF	Code	25V	30V	50V	60V	75V	100V	125V
10	106						A	A
15	156						A	A
33	336					A		
47	476			A	A		B	B
68	686		A				B	D
100	107							
110	107	A				B		
120	127				B		D	E
150	157							
220	227			B			E	
330	337				D	D		
390	397							
470	477	B	B	D	E	E		
560	567			E				
680	687							
1000	108	D	D		E			
1200	128		E					
1500	158							
1800	106	E						
2200	155	E						

HOW TO ORDER

Military Type Designation: Capacitors, Fixed, Ceramic Dielectric, (Temperature Stable and General Purpose), High Reliability



Check for up-to-date CV Tables at <http://www.avx.com/docs/catalogs/mil123.pdf>

M123

Mil-Spec Number

A

Modification Spec.

01

Slash Sheet Number

BX

Temperature Characteristic

B

Voltage
B = 50
C = 100

103

Capacitance Code

K

Capacitance Tolerance
C = $\pm 0.25\mu\text{F}$
D = $\pm 0.5\mu\text{F}$
F = $\pm 1\%$
J = $\pm 5\%$
K = $\pm 10\%$

C

Termination
C = Copper, solder coated (type C-4 or C-5 of MIL-STD-1276)
W = Copper clad steel, solder coated, 60 micro inches minimum.

Capacitance change with reference to 25°C over temperature range -55°C to +125°C		
Symbol	Without Voltage	With Rated DC Voltage
BP	$0 \pm 30 \text{ ppm/}^\circ\text{C}$	$0 \pm 30 \text{ ppm/}^\circ\text{C}$
BX	$\pm 15, -15\%$	$\pm 15, -25\%$

CROSS REFERENCE MIL-SPEC TEST REQUIREMENTS

TEST DESCRIPTION	MIL-PRF-123	MIL-PRF-39014	MIL-PRF-20	MIL-PRF-55681
NDT (Non-Destructive Test)	100% Ultrasonic Scan or Neutron-Radiography	No	No	No
Pre-Cap Visual (Pre-Encapsulation Visual Examination)	100%	No	No	No
D.P.A. (Destructive Physical Analysis)	Lot by Lot—Pre-Termination Lot by Lot—Finished Product	No	No	No
Pre-Cap Terminal Strength (Pre-Encapsulation Pull Test)	Lot by Lot	No	No	No
Life Test (Lot by Lot)	Lot by Lot—1000 Hours	No	No	No
Low Voltage Humidity	Lot by Lot	No	No	No
Thermal Shock 100 Cycles	Lot by Lot	No	No	No

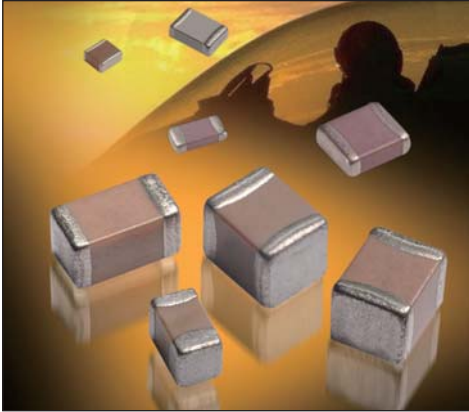

AVX Corp.'s M123 Series MIL-qualified ceramic capacitors are designed for high performance applications in BX and BR voltage levels, and for temperature stable applications in BP and BG voltage levels. The M123A10-M123A13 have been tested in accordance with MIL-PRF-123 specifications and are available in a wide range of values and tolerances.

M123 Series capacitors offer design and component engineers a proven technology for SMD processing and applications requiring space-level reliability. They are designed for use in critical frequency applications, timing circuits, and applications where absolute stability is required (BP and BG), as well as in applications where a wider capacitance variation in temperature, voltage, frequency, and life span can be tolerated (BX and BR).

Check for up-to-date CV Tables at <http://www.avx.com/docs/catalogs/mil123.pdf>

HOW TO ORDER

Military Type Designation: Capacitors, Fixed, Ceramic Dielectric, (Temperature Stable and General Purpose), High Reliability

M123	A	01	BX	B	103	K	S
Mil-Spec Number	Modification Spec.	Slash Sheet Number	Temperature Characteristic	Voltage B = 50 C = 100	Capacitance Code	Capacitance Tolerance C = ±0.25pF D = ±0.5pF F = ±1% J = ±5% K = ±10%	Termination G = Silver - Nickel - Gold M = Palladium/Silver S = Silver - Nickel - Solder Coated Z = Silver - Nickel - Solder Plated (tin/lead alloy with a minimum of 4 percent lead)

Capacitance change with reference to 25°C over temperature range -55°C to +125°C		
Symbol	Without Voltage	With Rated DC Voltage
BP	0 ± 30 ppm/°C	0 ± 30 ppm/°C
BX	±15, -15%	±15, -25%

DIMENSIONS

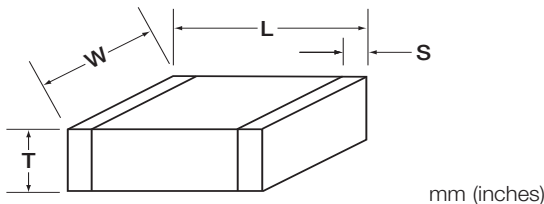

(L) Length	(W) Width	(T) Thickness	(S) Termination Band
CKS51, /10, 0805 Size Chip			
2.03 (0.080) ± 0.381 (0.015)	1.27 (0.050) ± 0.381 (0.015)	0.508 (0.020) Min. 1.40 (0.055) Max.	0.508 (0.020) ± 0.254 (0.010)
CKS52, /11, 1210 Size Chip			
3.05 (0.120) ± 0.381 (0.015)	2.54 (0.100) ± 0.381 (0.015)	0.508 (0.020) Min. 1.65 (0.065) Max.	0.508 (0.020) ± 0.254 (0.010)
CKS52, /12, 1808 Size Chip			
4.57 (0.180) ± 0.381 (0.015)	2.03 (0.080) ± 0.381 (0.015)	0.508 (0.020) Min. 1.65 (0.065) Max.	0.508 (0.020) ± 0.254 (0.010)
CKS54, /13, 2225 Size Chip			
5.59 (0.220) ± 0.381 (0.015)	6.35 (0.250) ± 0.381 (0.015)	0.508 (0.020) Min. 1.78 (0.070) Max.	0.508 (0.020) ± 0.254 (0.010)
CKS55, /21, 1206 Size Chip			
3.05 (0.120) ± 0.381 (0.015)	1.52 (0.0600) ± 0.381 (0.015)	0.508 (0.020) Min. 1.65 (0.065) Max.	0.508 (0.020) ± 0.254 (0.010)
CKS56, /22, 1812 Size Chip			
4.57 (0.180) ± 0.381 (0.015)	3.18 (0.125) ± 0.381 (0.015)	0.508 (0.020) Min. 2.03 (0.080) Max.	0.508 (0.020) ± 0.254 (0.010)
CKS56, /23, 1825 Size Chip			
4.57 (0.180) ± 0.381 (0.015)	6.35 (0.250) ± 0.381 (0.015)	0.508 (0.020) Min. 2.03 (0.080) Max.	0.508 (0.020) ± 0.254 (0.010)

Slash Sheet	Case Size	Dielectric	Cap Range
10	0805	BP	1.0-680
		BX	330-470000
11	1210	BP	300-3,300
		BX	5,600-100,000
12	1808	BP	300-1,000
		BX	5,600-100,000
13	2225	BP	1,100-10,000
		BX	120,000-1,000,000
21	1206	BP	1.0-2,200
		BX	4,700-39,000
22	1812	BP	1,200-10,000
		BX	27,000-180,000
23	1825	BP	3,900-20,000
		BX	56,000-470,000

MIL-PRF-55681 Chips

CDR01-CDR06

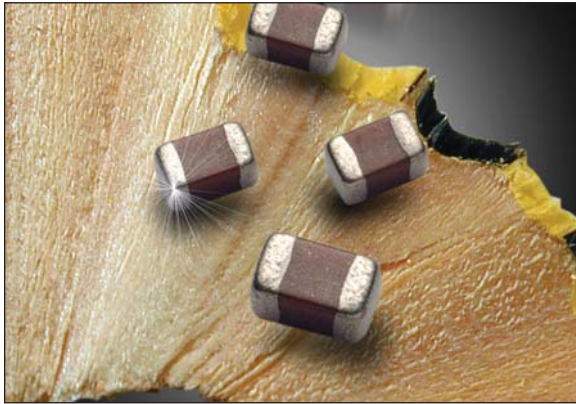

The CDR01 through CDR06 series (MIL-PRF-55681) of high reliability, high frequency capacitors are available in BP and BX, voltage/temperature options. They are offered in 50 and 100V versions and capacitance tolerance varies with capacitance and voltage specifications. Failure rates are between “S” = 0.001% and “M” = 1.0%.



Check for up-to-date CV Tables at

<http://www.avx.com/docs/catalogs/cdr01-06.pdf>

HOW TO ORDER

CDR01

MIL Style
 CDR01
 CDR02
 CDR03
 CDR04
 CDR05
 CDR06

BP

Voltage Temperature Limits
 BP = 0 ± 30 ppm/ $^{\circ}$ C without voltage;
 0 ± 30 ppm/ $^{\circ}$ C with rated voltage from -55° C to $+125^{\circ}$ C
 BX = $\pm 15\%$ without voltage;
 $+15 -25\%$ with rated voltage from -55° C to $+125^{\circ}$ C

101

Capacitance
 Two digit figures followed by multiplier (number of zeros to be added)
 e.g. 101 = 100pF

B

Rated Voltage
 A = 50V
 B = 100V

K

Capacitance Tolerance
 J = $\pm 5\%$
 K = $\pm 10\%$
 M = $\pm 20\%$

S

Termination Finish
 M = Palladium Silver
 N = Silver Nickel Gold
 S = Solder-Coated
 U = Base Metallization/Barrier Metal/Solder Coated*
 W = Base Metallization/Barrier Metal/Tinned (Tin or Tin/Lead Alloy)

M

Failure Rate Level
 M = 1.0%
 P = .1%
 R = .01%
 S = .001%

NOTE: Contact factory for availability of Termination and Tolerance Options for Specific Part Numbers.

*Solder shall have a melting point of 200 $^{\circ}$ C or less.

PACKAGING

Bulk is standard packaging. Tape and reel per RS481 is available upon request.

CDR01 thru CDR06 to MIL-PRF-55681

Military Type Designation	Capacitance in pF	Capacitance tolerance	Rated temperature and voltage-temperature limits	WVDC
AVX Style 0805/CDR01				
CDR01BP100B---	10	J,K	BP	100
CDR01BP120B---	12	J	BP	100
CDR01BP150B---	15	J,K	BP	100
CDR01BP180B---	18	J	BP	100
CDR01BP220B---	22	J,K	BP	100
CDR01BP270B---	27	J	BP	100
CDR01BP330B---	33	J,K	BP	100
CDR01BP390B---	39	J	BP	100
CDR01BP470B---	47	J,K	BP	100
CDR01BP560B---	56	J	BP	100
CDR01BP680B---	68	J,K	BP	100
CDR01BP820B---	82	J	BP	100
CDR01BP101B---	100	J,K	BP	100
CDR01B--121B---	120	J,K	BP,BX	100
CDR01B--151B---	150	J,K	BP,BX	100
CDR01B--181B---	180	J,K	BP,BX	100
CDR01BX221B---	220	K,M	BX	100
CDR01BX271B---	270	K	BX	100
CDR01BX331B---	330	K,M	BX	100
CDR01BX391B---	390	K	BX	100
CDR01BX471B---	470	K,M	BX	100
CDR01BX561B---	560	K	BX	100
CDR01BX681B---	680	K,M	BX	100
CDR01BX821B---	820	K	BX	100
CDR01BX102B---	1000	K,M	BX	100
CDR01BX122B---	1200	K	BX	100
CDR01BX152B---	1500	K,M	BX	100
CDR01BX182B---	1800	K	BX	100
CDR01BX222B---	2200	K,M	BX	100
CDR01BX272B---	2700	K	BX	100
CDR01BX332B---	3300	K,M	BX	100
CDR01BX392A---	3900	K	BX	50
CDR01BX472A---	4700	K,M	BX	50
AVX Style 1805/CDR02				
CDR02BP221B---	220	J,K	BP	100
CDR02BP271B---	270	J	BP	100
CDR02BX392B---	3900	K	BX	100
CDR02BX472B---	4700	K,M	BX	100
CDR02BX562B---	5600	K	BX	100
CDR02BX682B---	6800	K,M	BX	100
CDR02BX822B---	8200	K	BX	100
CDR02BX103B---	10,000	K,M	BX	100
CDR02BX123A---	12,000	K	BX	50
CDR02BX153A---	15,000	K,M	BX	50
CDR02BX183A---	18,000	K	BX	50
CDR02BX223A---	22,000	K,M	BX	50

- Add appropriate failure rate
- Add appropriate termination finish
- Capacitance Tolerance

Military Type Designation	Capacitance in pF	Capacitance tolerance	Rated temperature and voltage-temperature limits	WVDC
AVX Style 1808/CDR03				
CDR03BP331B---	330	J,K	BP	100
CDR03BP391B---	390	J	BP	100
CDR03BP471B---	470	J,K	BP	100
CDR03BP561B---	560	J	BP	100
CDR03BP681B---	680	J,K	BP	100
CDR03BP821B---	820	J	BP	100
CDR03BP102B---	1000	J,K	BP	100
CDR03BX123B---	12,000	K	BX	100
CDR03BX153B---	15,000	K,M	BX	100
CDR03BX183B---	18,000	K	BX	100
CDR03BX223B---	22,000	K,M	BX	100
CDR03BX273B---	27,000	K	BX	100
CDR03BX333B---	33,000	K,M	BX	100
CDR03BX393A---	39,000	K	BX	50
CDR03BX473A---	47,000	K,M	BX	50
CDR03BX563A---	56,000	K	BX	50
CDR03BX683A---	68,000	K,M	BX	50
AVX Style 1812/CDR04				
CDR04BP122B---	1200	J	BP	100
CDR04BP152B---	1500	J,K	BP	100
CDR04BP182B---	1800	J	BP	100
CDR04BP222B---	2200	J,K	BP	100
CDR04BP272B---	2700	J	BP	100
CDR04BP332B---	3300	J,K	BP	100
CDR04BX393B---	39,000	K	BX	100
CDR04BX473B---	47,000	K,M	BX	100
CDR04BX563B---	56,000	K	BX	100
CDR04BX823A---	82,000	K	BX	50
CDR04BX104A---	100,000	K,M	BX	50
CDR04BX124A---	120,000	K	BX	50
CDR04BX154A---	150,000	K,M	BX	50
CDR04BX184A---	180,000	K	BX	50
AVX Style 1825/CDR05				
CDR05BP392B---	3900	J,K	BP	100
CDR05BP472B---	4700	J,K	BP	100
CDR05BP562B---	5600	J,K	BP	100
CDR05BX683B---	68,000	K,M	BX	100
CDR05BX823B---	82,000	K	BX	100
CDR05BX104B---	100,000	K,M	BX	100
CDR05BX124B---	120,000	K	BX	100
CDR05BX154B---	150,000	K,M	BX	100
CDR05BX224A---	220,000	K,M	BX	50
CDR05BX274A---	270,000	K	BX	50
CDR05BX334A---	330,000	K,M	BX	50
AVX Style 2225/CDR06				
CDR06BP682B---	6800	J,K	BP	100
CDR06BP822B---	8200	J,K	BP	100
CDR06BP103B---	10,000	J,K	BP	100
CDR06BX394A---	390,000	K	BX	50
CDR06BX474A---	470,000	K,M	BX	50

- Add appropriate failure rate
- Add appropriate termination finish
- Capacitance Tolerance

MIL-PRF-55681 Chips

CDR31-CDR35

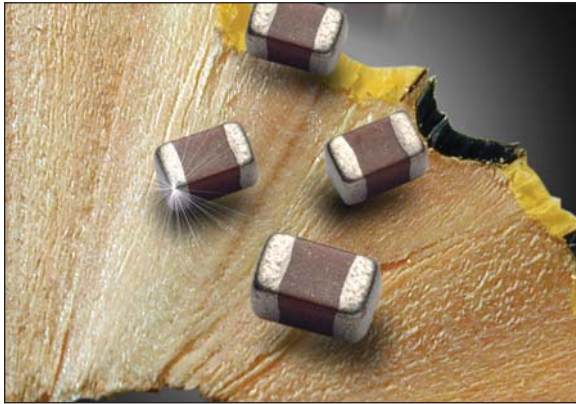

The CDR31 through CDR35 series (MIL-PRF-55681) of high reliability, high frequency capacitors are available in BP and BX, voltage/temperature options. They have a metric dimension body size and are offered in 50 and 100V versions. Capacitance tolerance varies with capacitance and voltage specifications and failure rates are between "S" = 0.001% and "M" = 1.0%.

Check for up-to-date CV Tables at <http://www.avx.com/docs/catalogs/cdr31-35.pdf>

HOW TO ORDER

CDR31

MIL Style
CDR31
CDR32
CDR33
CDR34
CDR35

BP

Voltage Temperature Limits
BP = 0 ± 30 ppm/°C without voltage;
 0 ± 30 ppm/°C with rated voltage from -55°C to +125°C
BX = $\pm 15\%$ without voltage;
 $+15 -25\%$ with rated voltage from -55°C to +125°C

101

Capacitance
Two digit figures followed by multiplier (number of zeros to be added)
e.g. 101 = 100pF

B

Rated Voltage
A = 50V
B = 100V

K

Capacitance Tolerance
C = $\pm .25$ pF
D = $\pm .5$ pF
F = $\pm 1\%$
J = $\pm 5\%$
K = $\pm 10\%$
M = $\pm 20\%$

S

Termination Finish
M = Palladium Silver
N = Silver Nickel Gold
S = Solder-Coated
Y = 100% Tin
U = Base Metallization/Barrier Metal/Solder Coated*
W = Base Metallization/Barrier Metal/Tinned (Tin or Tin/Lead Alloy)

M

Failure Rate Level
M = 1.0%
P = .1%
R = .01%
S = .001%

NOTE: Contact factory for availability of Termination and Tolerance Options for Specific Part Numbers.

*Solder shall have a melting point of 200°C or less.

PACKAGING

Bulk is standard packaging. Tape and reel per RS481 is available upon request.

CDR31 thru CDR35 to MIL-PRF-55681

Type	Dielectric	Capacitance pF	Tolerance	Voltage WVDC
CDR31	BP	1.0 - 2.4	B,C	100
CDR31	BP	2.7 - 9.1	B,C,D	100
CDR31	BP	10.0 - 470	F,J,K	100
CDR31	BP	510 - 680	F,J,K	50
CDR31	BX	470 - 4,700	K,M	100
CDR31	BX	5,600 - 18,000	K,M	100
CDR32	BP	1.0 - 2.4	B,C	100
CDR32	BP	2.7 - 9.1	B,C,D	100
CDR32	BP	10.0 - 1,000	F,J,K	100
CDR32	BP	1,100 - 2,200	F,J,K	50
CDR32	BX	4,700 - 15,000	K,M	100
CDR32	BX	18,000 - 39,000	K,M	50
CDR33	BP	1,000 - 2,200	F,J,K	100
CDR33	BP	2,700 - 3,300	F,J,K	50
CDR33	BX	15,000 - 27,000	K,M	100
CDR33	BX	39,000 - 100,000	K,M	50
CDR34	BP	2,200 - 4,700	F,J,K	100
CDR34	BP	5,100 - 10,000	F,J,K	50
CDR34	BX	27,000 - 56,000	K,M	100
CDR34	BX	100,000 - 180,000	K,M	50
CDR35	BP	4,700 - 10,000	F,J,K	100
CDR35	BP	11,000 - 22,000	F,J,K	50
CDR35	BX	56,000 - 150,000	K,M	100
CDR35	BX	180,000 - 470,000	K,M	50

Additional Surface Mount MLCC with DSCC Approvals

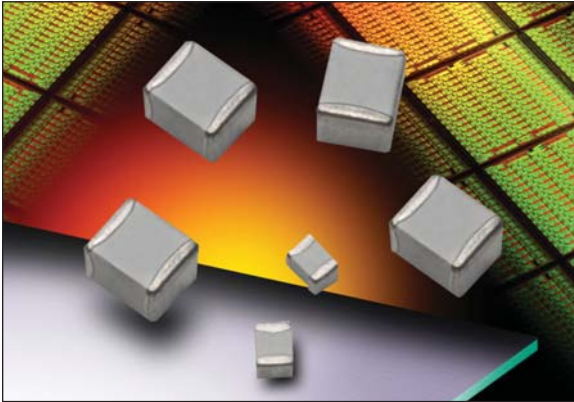

These additional ranges of surface mount multilayer ceramic capacitors provide additional capability in 0603 and 0402 case sizes. DSCC 03028 covers 0603 case size BP and BR dielectric and DSCC 03029 is for 0402 case size in BP and BR dielectric.

For RF surface mount capacitor versions DSCC 06019 covers 0605 case size for BP and BG dielectric. DSCC 06022 is for 1210 case size and BP and BG dielectric devices.

DSCC 05002 covers RF capacitors in 0603 case size, COG dielectric.

DSCC 03028 0603 Case Size

Type	Dielectric	Capacitance pF	Tolerance	Voltage WVDC
DSCC 03028	BP	0.5 - 9.1	C,D	6.3/10/16/25/50/100
DSCC 03028	BP	10 - 330	F,G,J	6.3/10/16/25/50/100
DSCC 03028	BP	390 - 1,000	F,G,J	6.3/10/16/25/50
DSCC 03028	BP	1,200 - 1,500	F,G,J	6.3/10/16/25
DSCC 03028	BR	100 - 1,000	K,M	6.3/10/16/25/50/100/200
DSCC 03028	BR	1,200 - 12,000	K,M	6.3/10/16/25/50/100
DSCC 03028	BR	15,000 - 39,000	K,M	6.3/10/16/25/50
DSCC 03028	BR	47,000	K,M	6.3/10/16/25
DSCC 03028	BR	56,000 - 100,000	K,M	6.3/10/16
DSCC 03028	BR	120,000 - 220,000	K,M	6.3/10

DSCC 03029 0402 Case Size

Type	Dielectric	Capacitance pF	Tolerance	Voltage WVDC
DSCC 03029	BP	0.5 - 9.1	C,D	6.3/10/16/25/50
DSCC 03029	BP	10 - 220	F,G,J	6.3/10/16/25/50
DSCC 03029	BP	270 - 330	F,G,J	6.3/10/16
DSCC 03029	BR	100 - 3,300	K,M	6.3/10/16/25/50
DSCC 03029	BR	3,900 - 4,700	K,M	6.3/10/16/25

DSCC 06019 RF Capacitor 0605 Case Size

Type	Dielectric	Capacitance pF	Tolerance	Voltage WVDC
DSCC 06019	BP,BG	0.1 - 0.2	B	50/150
DSCC 06019	BP,BG	0.3 - 0.4	B,C	50/150
DSCC 06019	BP,BG	0.5 - 6.2	B,C,D	50/150
DSCC 06019	BP,BG	6.8 - 9.1	B,C,J,K,M	50/150
DSCC 06019	BP,BG	10 - 100	F,G,J,K,M	50/150
DSCC 06019	BP,BG	110 - 1,000	F,G,J,K,M	50

DSCC 06022 RF Capacitor 1210 Case Size

Type	Dielectric	Capacitance pF	Tolerance	Voltage WVDC
DSCC 06022	BP,BG	0.1 - 0.2	B	200/500
DSCC 06022	BP,BG	0.3 - 0.4	B,C	200/500
DSCC 06022	BP,BG	0.5 - 6.2	B,C,D	200/500
DSCC 06022	BP,BG	6.8 - 9.1	B,C,J,K,M	200/500
DSCC 06022	BP,BG	10 - 100	F,G,J,K,M	200/500
DSCC 06022	BP,BG	110 - 200	F,G,J,K,M	200/300
DSCC 06022	BP,BG	220 - 470	F,G,J,K,M	200
DSCC 06022	BP,BG	510 - 620	F,G,J,K,M	100
DSCC 06022	BP,BG	680 - 1,000	F,G,J,K,M	50
DSCC 06022	BP	1,100 - 5,100	F,G,J,K,M	50

DSCC 05002 0603 Case Size

Type	Dielectric	Capacitance pF	Tolerance	Voltage WVDC
DSCC 05002	COG	0.1 - 0.2	A,B	50/100/200/250
DSCC 05002	COG	0.3 - 1	A,B,C	50/100/200/250
DSCC 05002	COG	1.1 - 6.2	A,B,C,D	50/100/200/250
DSCC 05002	COG	6.8 - 100	B,C,J,K,M	50/100/200/250

HOW TO ORDER

03028

Case Size
03028 (0403)
03029 (0402)
05002 (0603)
05006 (0805)
05007 (1206)
06022 (1210)
06019 (0605)

BX

Voltage Temperature Limits
BP = 0 ± 30 ppm/°C without voltage;
0 ± 30 ppm/°C with rated voltage from -55°C to +125°C
BR = ±15% without voltage;
+15 -40% with rated voltage from -55°C to +125°C
BX = ±15% without voltage;
+15 -25% with rated voltage from -55°C to +125°C

102

Capacitance
EIA Capacitance Code in pF
First two digits = significant figures or "R" for decimal place
Third digit = number of zeros or after "R" significant figures.

B

Rated Voltage
W = 6.3V
X = 10V
Y = 16V
Z = 25V
A = 50V
B = 100V
C = 200V

J

Capacitance Tolerance
B = ±1 pF
C = ±.25 pF
D = ±.5 pF
F = ±1%
G = ±2%
J = ±5%
K = ±10%
M = ±20%

U

Termination Finish
M = Palladium Silver
U = Solder Coated (4% Lead min) Melting Point of 200°C
Z = Tin/Lead Alloy with 4% Lead

-

Options
C = Full Group G
L = 2000 Hour Life
M = 1000 Hour Life
H = Low Voltage Humidity

Extended Range Surface Mount MLCC to DSCC Drawings



These extended range surface mount, multilayer ceramic capacitors provide options for lower voltages and higher capacitance versions to DSCC drawings. Dielectric options are BP, BR and BX. DSCC 05006 covers 0805 case size and DSCC 05007 provides the 1206 case size capability.

DSCC 05006 0805 Case Size

Type	Dielectric	Capacitance pF	Tolerance	Voltage WVDC
DSCC 05006	BP	0.5	C,D	16/25/50/100/200
DSCC 05006	BP	1 - 8.2	C,D	16/25/50/200
DSCC 05006	BP	10 - 470	F,G,J	16/25/50/200
DSCC 05006	BP	560 - 680	F,G,J	16/25/100/200
DSCC 05006	BP	820 - 1,000	F,G,J	16/25/50/100
DSCC 05006	BP	1,200 - 3,900	F,G,J	16/25/50
DSCC 05006	BP	4,700 - 5,600	F,G,J	16/25
DSCC 05006	BP	6,800 - 8,200	F,G,J	16
DSCC 05006	BR	330 - 22,000	K,M	10/16/25/50/100/200
DSCC 05006	BR	33,000 - 47,000	K,M	10/16/25/50/100
DSCC 05006	BR	68,000 - 100,000	K,M	10/16/25/50/100
DSCC 05006	BR	150,000	K,M	10/16/25/50
DSCC 05006	BR	220,000	K,M	10/16/25
DSCC 05006	BR	330,000 - 470,000	K,M	10/16
DSCC 05006	BR	680,000 - 1µF	K,M	10

DSCC 05007 1206 Case Size

Type	Dielectric	Capacitance pF	Tolerance	Voltage WVDC
DSCC 05007	BP	0.5 - 8.2	C,D	16/25/50/100/200
DSCC 05007	BP	10 - 680	F,G,J	16/25/50/100/200
DSCC 05007	BP	820 - 1,000	F,G,J	16/25/50/100
DSCC 05007	BP	1,200 - 3,900	F,G,J	16/25/50
DSCC 05007	BP	4,700 - 5,600	F,G,J	16/25
DSCC 05007	BP	6,800 - 8,200	F,G,J	16
DSCC 05007	BR	1,500 - 6,800	K,M	10/16/25/50/100/200
DSCC 05007	BR	10,000	K,M	10/16/25/50/100
DSCC 05007	BR	15,000 - 33,000	K,M	10/16/25/50
DSCC 05007	BR	47,000	K,M	10/16/25
DSCC 05007	BR	68,000	K,M	10/16
DSCC 05007	BR	100,000	K,M	10/16/25
DSCC 05007	BR	150,000 - 220,000	K,M	10

HOW TO ORDER

03028	BX	102	B	J	U	-
Case Size 03028 (0403) 03029 (0402) 05002 (0603) 05006 (0805) 05007 (1206) 06022 (1210) 06019 (0605)	Voltage Temperature Limits BP = 0 ± 30 ppm/°C without voltage; 0 ± 30 ppm/°C with rated voltage from -55°C to +125°C BR = ±15% without voltage; +15 -40% with rated voltage from -55°C to +125°C BX = ±15% without voltage; +15 -25% with rated voltage from -55°C to +125°C	Capacitance EIA Capacitance Code in pF First two digits = significant figures or "R" for decimal place Third digit = number of zeros or after "R" significant figures.	Rated Voltage W = 6.3V X = 10V Y = 16V Z = 25V A = 50V B = 100V C = 200V	Capacitance Tolerance B = ±.1 pF C = ±.25 pF D = ±.5 pF F = ±1% G = ±2% J = ±5% K = ±10% M = ±20%	Termination Finish M = Palladium Silver U = Solder Coated (4% Lead min) Melting Point of 200°C Z = Tin/Lead Alloy with 4% Lead	Options C = Full Group G L = 2000 Hour Life M = 1000 Hour Life H = Low Voltage Humidity

Stacked Leaded MLC Capacitors

SM0 Series



AVX IS QUALIFIED TO MIL-PRF-49470/1 AND MIL-PRF-49470/2

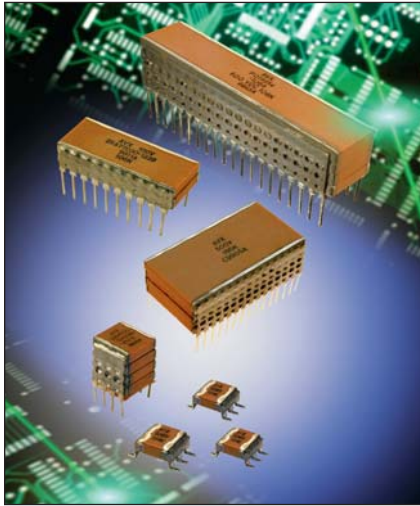

The SMPS capacitors are designed for high current, high-power and high-temperature applications. These capacitors have very low ESR (Equivalent Series Resistance) and ESL (Equivalent Series Inductance). SMPS Series capacitors offer design and component engineers a proven technology specifically designed for programs requiring high reliability performance in harsh environments.

MIL-PRF-49470 SMPS Series capacitors are primarily used in input/output filters of high-power and high-voltage power supplies as well as in bus filters and DC snubbers for high power inverters and other high-current applications. These capacitors are available with through-hole and surface mount leads. The operating temperature is -55°C to +125°C.

The MIL-PRF-49470 capacitors are preferred over the DSCC drawing 87106 capacitors. MIL-PRF-49470 specification was created to produce a robust replacement for DSCC 87106. MIL-PRF-49470 offers two product levels.

Level "B" is the standard reliability. Level "T" is the high reliability suitable for space application.

AVX is qualified to supply MIL-PRF-49470/1 parts. These are unencapsulated ceramic dielectric, switch mode power supply capacitors. AVX is also qualified to supply MIL-PRF-49470/2 parts. These are encapsulated ceramic dielectric, switch mode power supply capacitors.

Check for up-to-date CV Tables at <http://www.avx.com/docs/catalogs/sm01-06.pdf>

HOW TO ORDER AVX Styles: SM-1, SM-2, SM-3, SM-4, SM-5, SM-6

SM0	1	7	C	106	M	B	N	650
AVX Style Size	Size	Voltage	Temperature Coefficient	Capacitance Code (2 significant digits + no. of zeros)	Capacitance Tolerance	Test Level	Termination	Height Max Dimension "A"
SM0 = Uncoated SM5 = Epoxy Coated	5 = 50V 1 = 100V 2 = 200V 7 = 500V	C0G = A X7R = C	10 pF = 100 100 pF = 101 1,000 pF = 102 22,000 pF = 223 220,000 pF = 224 1 μF = 105 10 μF = 106 100 μF = 107	COG: J = ±5% K = ±10% M = ±20% X7R: K = ±10% M = ±20% Z = +80%, -20%	B = Hi-Rel*	N = Straight Lead J = Leads formed in L = Leads formed out	120 = 0.120" 240 = 0.240" 360 = 0.360" 480 = 0.480" 650 = 0.650"	

Note: Capacitors with X7R and Z5U dielectrics are not intended for applications across AC supply mains or AC line filtering with polarity reversal. Contact plant for recommendations.

*Hi-Rel screening for C0G and X7R only. Screening consists of 100% Group A (B Level), Subgroup 1 per MIL-PRF-49470.

SIZE CODE CAP	CASE CODE 1 WVDC				CASE CODE 2 WVDC				CASE CODE 3 WVDC				CASE CODE 4 WVDC				CASE CODE 5 WVDC				CASE CODE 6 WVDC				
	BX	BX	BR	BQ	BX	BX	BR	BQ	BX	BX	BR	BQ	BX	BX	BR	BQ	BX	BX	BR	BQ	BX	BX	BR	BQ	
μF	Code	50	100	200	500	50	100	200	500	50	100	200	500	50	100	200	500	50	100	200	500	50	100	200	500
0.15	154																								
0.18	184																								
0.22	224																								
0.27	274																								
0.33	334																								
0.39	394																								
0.47	474																								
0.56	564																								
0.68	684																								
0.82	824																								
1.0	105																								
1.2	125																								
1.5	155																								
1.8	185																								
2.2	225																								
2.7	275																								
3.3	335																								
3.9	395																								
4.7	475																								
5.6	565																								
6.8	685																								
8.2	825																								
10	106																								
12	126																								
15	156																								
18	186																								
22	226																								
27	276																								
33	336																								
39	396																								
47	476																								
56	566																								
68	686																								
82	826																								
100	107																								
120	127																								
150	157																								
180	187																								
220	227																								
270	277																								

Stacked Leaded MLC Capacitors

CH-CV Series

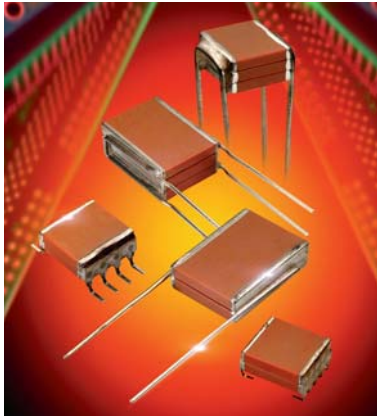

10nF to 180 μ F
 50V to 500 VDC
 -55°C to +125°C
 50-500V ESCC 3001/030

BS9100 approved
 Low ESR/ESL
 1B/C0G and 2C1/X7R Dielectrics
 1-3kV ESCC 3001/034

This range allows SMPS engineers to select the best volumetric solution for input and output filter applications in high reliability designs. Utilizing advanced multilayer ceramic techniques to minimize ESR/ESL giving high current handling properties appropriate for filtering, smoothing and decoupling circuits. CH-CV series parts are qualified for ESA.

Check for up-to-date CV Tables at
<http://www.avx.com/docs/catalogs/ch&cvca.pdf>

HOW TO ORDER

CV T	52 T	5 T	C T	106 T	M T	G T	3 T	0 T	A T	2 T
Style Code	Size Code	Voltage Code	Dielectric Code	Capacitance Code (2 significant digits + no. of zeros) Examples: 1 μ F = 105 10 μ F = 106 100 μ F = 107	Capacitance Tolerance J = \pm 5% K = \pm 10% M = \pm 20% P = -0 +100%	Specification Code A = Non-customized G = 9100	Finish Code 3 = Uncoated 8 = Coated (classified as uninsulated)	Lead Dia. Code 0 = Standard	Lead Space Code A = Standard	Lead Style Code 2 = 2 Terminal 4 = 4 Terminal This style is only available in 3 & 4 chip assemblies
CH T	52 T	5 T	C T	106 T	M T	G T	3 T	0 T	A T	0 T
Style Code	Size Code	Voltage Code	Dielectric Code	Capacitance Code (2 significant digits + no. of zeros) Examples: 1 μ F = 105 10 μ F = 106 100 μ F = 107	Capacitance Tolerance J = \pm 5% K = \pm 10% M = \pm 20% P = -0 +100%	Specification Code A = Non-customized G = 9100	Finish Code 3 = Uncoated 8 = Coated (classified as uninsulated)	Lead Dia. Code 0 = Standard	Lead Space Code A = Standard	Lead Style Code 0 = Straight dual in line 4 = 4 Terminal

CAPACITANCE VALUE

		C0G		X7R	
		Min Cap μ F	Max Cap μ F	Min Cap μ F	Max Cap μ F
CH/CV41-44	50	0.068	0.39	1.8	12
	100	0.047	0.33	1.0	10
	200	0.033	0.27	0.33	2.2
	500	0.01	0.068	0.12	1.0
CH/CV51-54	50	0.12	0.68	3.9	22
	100	0.10	0.47	2.2	15
	200	0.068	0.39	0.68	3.9
	500	0.022	0.1	0.27	1.5
CH/CV61-64	50	0.22	1.2	6.8	39
	100	0.15	1.0	4.7	33
	200	0.12	0.68	1.0	10
	500	0.033	0.22	0.47	3.3
CH/CV71-74	50	0.39	2.2	12	68
	100	0.27	1.8	8.2	47
	200	0.22	1.2	2.2	12
	500	0.068	0.39	0.82	5.6
CH/CV76-79	50	0.39	2.2	12	68
	100	0.27	1.8	8.2	47
	200	0.22	1.2	2.2	12
	500	0.068	0.39	0.82	5.6
CH/CV81-84	50	0.39	2.7	15	82
	100	0.27	2.2	12	47
	200	0.22	1.8	2.2	12
	500	0.068	0.56	0.82	5.6
CH/CV86-89	50	0.68	3.9	22	120
	100	0.56	3.3	15	68
	200	0.39	2.7	3.9	27
	500	0.12	0.82	1.5	8.2
CH/CV91-94	50	1.2	5.6	39	180
	100	1.0	4.7	33	150
	200	0.82	3.9	8.2	39
	500	0.22	1.5	2.7	18

Leaded SMPS MLCC

BR Series (CECC) for Output Filtering

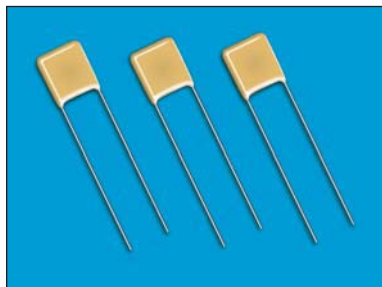

AVX also offers ESA qualified and CECC approved SMPS capacitors, the BR series. These are coated radial capacitors that are offered in ranges from 50V to 500V and available in COG and X7R type dielectrics. These capacitors are designed to withstand the harsh conditions found in input and output filtering requirements for today's demanding switch mode power supply applications. Customized and custom versions are also available.

Check for up-to-date CV Tables at <http://www.avx.com/docs/catalogs/smpscecc.pdf>

HOW TO ORDER

BR T	84 T	1 T	C T	156 T	K T	T T	A T
Style Code	Size Code	Voltage Code	Dielectric Code	Capacitance Code	Capacitance Tolerance	Specification Code	Lead Length Code
		5 = 50V 1 = 100V 2 = 200V 7 = 500V	A = COG C = X7R	2 Sig. Digits + Number of Zeros	G = ±2% COG only J = ±5% COG only K = ±10% M = ±20% P = -0 +100%	T = CECC	A = 31.7mm min.

Note: If tape and reel is required, add TR to the end of the part number.

CECC Offering

	1B/COG CECC 30 601 801 Issue 1				2C1/X7R CECC 30 701 801 Issue 1			
	50V	100V	200V	500V	50V	100V	200V	500V
BR40	683-104	473-683	333-473	4R5-153	185-275	125-185	334-474	473-154
BR50	124-224	104-154	683-104	820-333	395-475	225-395	684-105	104-394
BR84	104-564	104-474	104-334	223-104	475-186	475-156	105-335	474-155

High Voltage Ceramic Capacitors

Type HP/HW

Type HD/HE



SELECTION GUIDE

Main Signal Component	Application	Series	Type	Size	Finish
Pulses AC or DC	High Energy Pulses or AC or DC	Molded discs with connections	HP	30 40 50 60	Epoxy potted
		Uncoated discs with connections	HW	30 40 50 60	Uncoated
AC	AC Voltage dividers at line frequency	Molded discs with connectors	HD	30 40 60	Epoxy potted
		Uncoated discs with connectors	HE	30 40 60	Uncoated



Check for up-to-date CV Tables at

<http://www.avx.com/docs/catalogs/hp-hw-hk.pdf>

GENERAL CHARACTERISTICS

HIGH VOLTAGE / AC USES

- The main applications include live line indicators, AC dividers, grading systems for power distribution network, protection for HV switches and power circuit breakers. Coupling, by-passing high frequency circuits also use HV ceramic disc capacitors.
- These applications require:
 - a high internal resistance.
 - a high dielectric strength.
 - low or moderate losses at working frequencies (from 50 Hz up to 10 kHz).

The active power (or losses) being:

$$W_a = 2\pi f C \cdot \text{tg } \delta \cdot V^2 = k (C \cdot \text{tg } \delta) (F \cdot V^2)$$

This shows that improved performances are obtained when:

- Good dielectric properties (low tg δ) and
- No long term overvoltage are present and
- Capacitors free of “partial discharge” (corona) effect, up to rated rms voltage.

TPC is able to perform “discharge free test” and may guarantee a rate as low as 5 picocoulombs at V_{rms} upon request.

- High voltage capacitors for AC uses are mainly made of type II dielectrics. Most of these materials except strontium titanate exhibit a significant non-linearity. Consequently, the capacitance value depends on the voltage across the component and on the frequency of the applied signal.

HIGH ENERGY PULSES

- Laser pulses circuitry, high energy/high voltage test equipment (HV accelerators, physics research) require products especially adapted to their specific requirements.
- Because of the high energy involved, the design of the capacitors have to provide:

- a very low ESR (equivalent series resistance) to minimize the lost energy.

$$W = \int_0^{i_p} (ESR \cdot I^2) di$$

- a very low ESL (equivalent series inductance) to keep the correct pulse shape.

Typically due to the design of the electrodes, the products exhibit:

- ESR: ~ 10 mΩ
- ESL: < 30 nH
- peak current up to 50 kA
- a high withstanding of very large $\frac{dV}{dt}$ or short signal rise time.
- a high energy density J

$$J = \frac{1}{2} k \epsilon_0 \epsilon_r E^2 \text{ (with } E = V/m)$$

even under high electric field, (implying that ϵ_r is very little voltage dependent).

Through the use of almost linear or non-voltage dependent capacitors, the stored energy can reach 50 to 100 J/liter for the HP/HW products.

- To ensure these properties, traditional ferroelectric type II capacitors cannot be used due to their electrostrictive and piezoelectric properties. The capacitors use quasi “paraelectric”, strontium-based, ceramic material.
- The main applications are coupling, decoupling, multipliers circuits, HV DC power supplies, high voltage dividers.

CKR Series

Molded Ceramic Capacitors

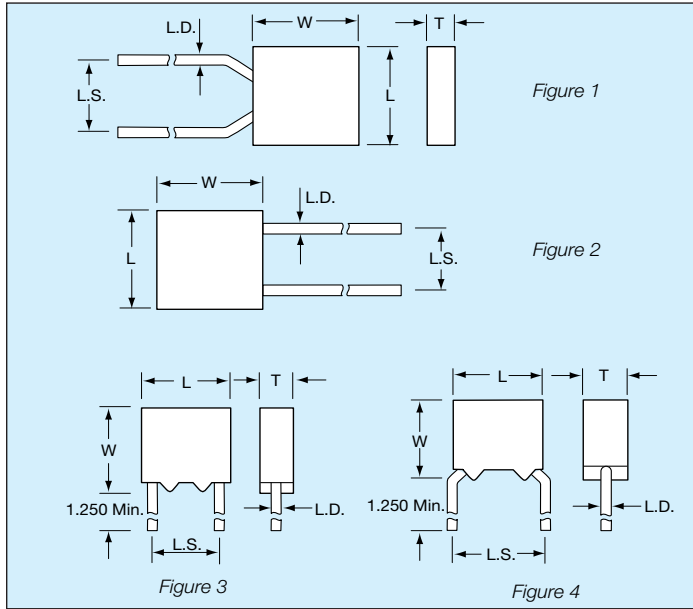

The CKR series of multilayer ceramic capacitors are molded radial and molded axial leaded devices. They provide a rugged construction and are designed specifically for military applications. Terminations are Tin/Lead for improved solderability. Available to military specifications MIL-PRF-39014, MIL-PRF-20 and MIL-C-11014.

Check for up-to-date CV Tables at <http://www.avx.com/docs/catalogs/ckr04-24.pdf>

HOW TO ORDER

Military Type Designation: Styles CKR04, CKR05, CKR06, CKR08, CKR11, CKR12, CKR14, CKR15, CKR16

Dash Number Option: MIL-PRF-39014/01 (Appropriate Dash Number)

CKR05

Style
 CK = General purpose, ceramic dielectric, fixed capacitors
 R = Established Reliability Parts
 05 = Remaining two numbers identify shape and dimension
 11 = Remaining two numbers identify shape and dimension

BX

Voltage-Temperature Limits
 First letter identifies temperature range.
 B = -55°C to +125°C
 Second letter identifies voltage-temperature coefficient.

Capacitance Change with Reference to 25°C		
Second Letter	No Voltage	Rated Voltage
X	+15, -15%	+15, -25%
R Axial Only	+15, -15%	+15, -40%

104

Capacitance
 First two digits are the significant figures of capacitance. Third digit indicates the additional number of zeros. For example, order 100,000 pF as 104. (For values below 10pF use "R" in place of decimal point, e.g., 1R4 = 1.4pF)

K

Capacitance Tolerance
 K = ±10%
 M = ±20%

S

Military Failure Rate
 M = 1% per 1000 hours
 P = 0.1% per 1000 hours
 R = 0.01% per 1000 hours
 S = 0.001% per 1000 hours
 Note:

AVX reserves the right to substitute a lower failure rate part per MIL-PRF-39014. Substitutability for failure rate levels shall be as follows:

Failure Rate Level	Will Replace Failure Rate Level
S (STD) (X-ray)	R, P, M, L
R (STD) (No X-ray)	P, M, L
P	M, L
M	L

(V)

Standoff Option
 To order standoff option, place "V" at the end of the part number.
 Example: CKR05BX104KSV

PACKAGING REQUIREMENTS

Packaging: 100 Pcs/bag; Radial Tape and Reel Packaging available upon request (2500 pcs./reel).

SIZE SPECIFICATIONS

Dimensions: Millimeters (Inches)

Per Mil Spec	Case Size				
	Length (L)	Width (W)	Thickness (T)	Lead Spacing (L.S.)	Lead Diameter (L.D.)
MIL-PRF-39014					
CKR04 (Fig. 2)	4.83±.25 (.190±.010)	4.83±.25 (.190±.010)	2.29±.25 (.090±.010)	2.54±.38 (.100±.015)	.64±.05 (.025±.002)
CKR05 (Fig. 1, 4)	4.83±.25 (.190±.010)	4.83±.25 (.190±.010)	2.29±.25 (.090±.010)	5.08±.38 (.200±.015)	.64±.05 (.025±.002)
CKR06 (Fig. 2, 3)	7.37±.25 (.290±.010)	7.37±.25 (.290±.010)	2.29±.25 (.090±.010)	5.08±.38 (.200±.015)	.64±.05 (.025±.002)
CKR08 (Fig. 2)	7.37±.25 (.290±.010)	7.37±.25 (.290±.010)	3.68±.38 (.145±.015)	5.08±.38 (.200±.015)	.64±.05 (.025±.002)

MARKING RADIAL LEAD

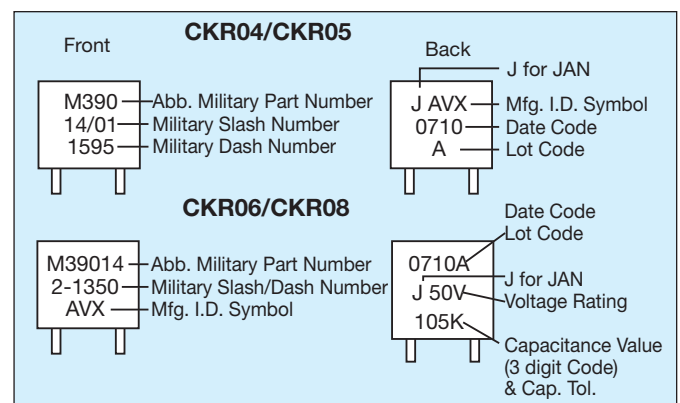

Single-In-Line Packages (SIP)

Capacitor Arrays

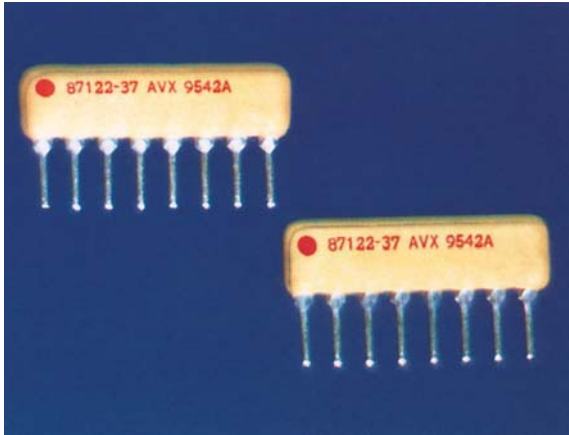

SIP-style, MLC ceramic capacitor arrays are Single-In-Line, conformally coated packages. These capacitor networks incorporate multiple capacitors into a single substrate and, therefore, offer excellent TC tracking. The utilization of SIP capacitor arrays minimizes board real estate and reduces component count in the assembly. Various circuit configurations and capacitance/voltage values are available.

HOW TO ORDER

SP ┆	A ┆	1 ┆	1 ┆	A ┆	561 ┆	K ┆	A ┆	A ┆
AVX Style	Circuit	Lead Style	Voltage 5 = 50V 1 = 100V	Temperature Coefficient C0G = A X7R = C Z5U = E	Capacitance Code (2 significant digits + no. of zeros) 10 pF = 100 100 pF = 101 1,000 pF = 102 22,000 pF = 223 220,000 pF = 224 1 μF = 105 10 μF = 106 100 μF = 107	Capacitance Tolerance C0G: J = ±5% K = ±10% M = ±20% X7R: K = ±10% M = ±20% Z = +80%, -20%	Test Level A = Standard	Number of Leads 2 = 2 A = 10 3 = 3 B = 11 4 = 4 C = 12 5 = 5 D = 13 6 = 6 E = 14 7 = 7 8 = 8 9 = 9

Maximum Capacitance*		
	50V	100V
C0G	2200 pF	1500 pF
X7R	0.10 μF	0.033 μF
Z5U	0.39 μF	0.10 μF

*For dimensions, voltages, or capacitance values not specified, please contact factory.

AVX IS QUALIFIED TO THE FOLLOWING DSCC DRAWINGS

SPECIFICATION #	DESCRIPTION	CIRCUIT	LEADS	CAPACITANCE RANGE
87112	BX-100 VDC	A	8	1000 pF - 0.1 μF
87116	C0G-100 VDC	A	8	10 pF - 820 pF
87119	BX-100 VDC	C	10	1000 pF - 0.1 μF
87120	C0G-100 VDC	C	10	10 pF - 1000 pF
87122	BX-100 VDC	B	8	1000 pF - 0.1 μF
88019	BX-100 VDC	A	10	1000 pF - 0.1 μF
89086	C0G-100 VDC	B	8	10 pF - 820 pF

MIL-PRF-55681 Chips

CDR11-CDR14

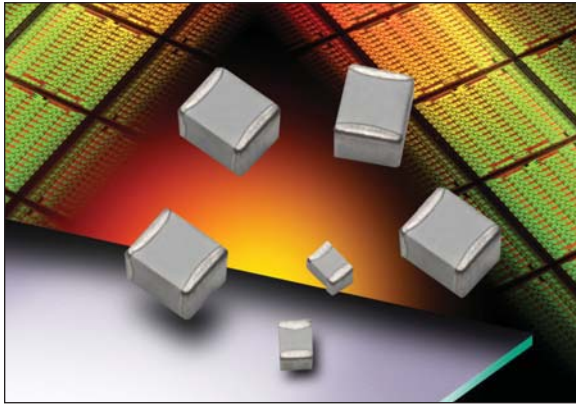

The CDR11 through CDR14 series (MIL-PRF-55681) of high reliability, high frequency capacitors are available in BG and BP, voltage/temperature options. They are offered in versions from 50 to 500V. Case sizes are 0605 for CDR11 & 12 and 1111 for CDR13 & 14. Failure rate are between "S" = 0.001% and "M" = 1.0%.

Check for up-to-date CV Tables at <http://www.avx.com/docs/catalogs/cdr11-14.pdf>

HOW TO ORDER

CDR12

MIL Style
CDR11
CDR12
CDR13
CDR14

BG

Voltage Temperature Limits
BG = +90 ± 20 ppm/°C with and without rated voltage from -55°C to +125°C
BP = 0 ± 30 ppm/°C with and without rated voltage from -55°C to +125°C

101

Capacitance
EIA Capacitance Code in pF
First two digits = significant figures or "R" for decimal place
Third digit = number of zeros or after "R" significant figures.

A

Rated Voltage
A = 50V
B = 100V
C = 200V
D = 300V
E = 500V

K

Capacitance Tolerance
B = ±.1 pF
C = ±.25 pF
D = ±.5 pF
F = ±1%
G = ±2%
J = ±5%
K = ±10%
M = ±20%

U

Termination Finish (Military Designations) Code
M = Palladium Silver (CDR11 & 13 only)
N = Silver, Nickel, Gold (CDR11 & 13 only)
S = Solder-Coated, Final (CDR12 & 14 only)
U = Base Metallization/Barrier Metal/Solder Coated* (CDR12 & 14 only)
W = Base Metallization/Barrier Metal/Tinned (Tin or Tin/Lead Alloy) (CDR12 & 14 only)
Y = 100% Tin
Z = Base Metallization, Barrier Metal (Tin/Lead Alloy with 4% Lead Min.)

S

Failure Rate Level
M = 1.0%
P = .1%
R = .01%
S = .001%

PACKAGING

Standard packaging = Waffle Pack (maximum quantity is 80)

CDR11 thru CDR14 to MIL-PRF-55681

Type	Dielectric	Capacitance pF	Tolerance	Voltage WVDC
CDR11/12	BG,BP	0.1 - 0.2	B	50
CDR11/12	BG,BP	0.3 - 0.4	B,C	50
CDR11/12	BG,BP	0.5 - 6.2	B,C,D	50
CDR11/12	BG,BP	6.8 - 9.1	B,C,J,K,M	50
CDR11/12	BG,BP	10 - 100	F,G,J,K,M	50
CDR11/12	BP	110 - 1,000	F,G,J,K,M	50
CDR13/14	BG,BP	0.1 - 0.2	B	200/500
CDR13/14	BG,BP	0.3 - 0.4	B,C	200/500
CDR13/14	BG,BP	0.5 - 6.2	B,C,D	200/500
CDR13/14	BG,BP	6.8 - 9.1	B,C,J,K,M	200/500
CDR13/14	BG,BP	10 - 100	F,G,J,K,M	200/500
CDR13/14	BG,BP	110 - 200	F,G,J,K,M	200/300
CDR13/14	BG,BP	220 - 470	F,G,J,K,M	200
CDR13/14	BG,BP	510 - 620	F,G,J,K,M	100
CDR13/14	BG,BP	680 - 1,000	F,G,J,K,M	50
CDR13/14	BP	1,100 - 5,100	F,G,J,K,M	50

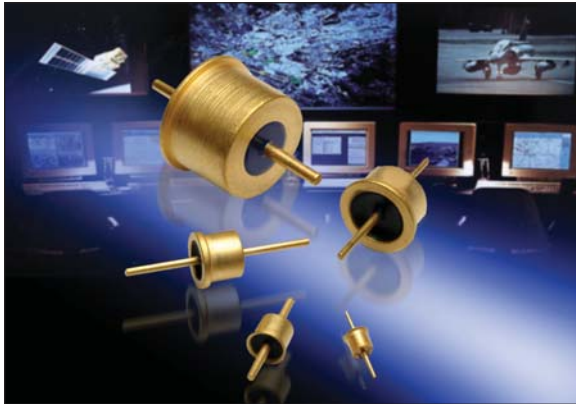

AVX solder-in style C and L section filters, utilize patented conductive polymer technology to provide effective attenuation in the RF to microwave frequency spectrum from 10MHz to 50GHz. Designed in accordance with MIL-PRF-28861, they perform well in high impedance circuits where large capacitance values are not practical. They are ideal for filtering signal/data lines of high impedance source and load systems. These filters are designed to be soldered into a package, bracket or bulkhead (and maintain hermeticity).

CHARACTERISTICS

- Miniature and Microminiature versions for Aerospace applications
- High temperature construction, withstands 300°C installation temperatures
- Rugged monolithic discoidal capacitor construction
- Custom lead lengths and capacitance values available on request
- Glass hermetic seal on one end with epoxy on the opposite end
- High purity gold plating provides excellent solderability or compatibility with thermal and ultrasonic wire bonding
- Rated DC current up to 10A
- NASA SSQ 21215-21218

[Check for up-to-date CV Tables at http://www.avx.com/docs/catalogs/zs-zr.pdf](http://www.avx.com/docs/catalogs/zs-zr.pdf)

HOW TO ORDER

ZS ┆	2 ┆	C ┆	2 ┆	B ┆	103 ┆	H ┆
Style	Circuit	Voltage	Options	MIL-28861 Screening	3 Digit Capacitor Code (in pF)	H = Polyimide Y = Solder Z = Braze
ZZ = (.118 Dia.) M28861/12 ZYS* = (.105 Dia.) ZXS* = (.075 Dia.) ZZS* = (.120 Dia.) ZS* = (.128 Dia.) M28861/12 ZR* = (.128 Dia.) M28861/12 YS* = (.165 Dia.) M28861/15 YR* = (.165 Dia.) M28861/15 XS* = (.250 Dia.) M28861/14 XR* = (.250 Dia.) M28861/14 WS* = (.400 Dia.) M28861/13 WR* = (.400 Dia.) M28861/13	1 = C Section (Feed Thru) 2 = L-Section 8 = Grounded Feed Thru	A = 100 VDC B = 200 VDC C = 50 VDC E = 400 VDC/230 VAC OR 400 VDC K = 250 VDC L = 300 VDC OR 200 VDC/115 VAC M = 350 VDC N = 70 VDC Y = 300 VDC Z = 400 VDC X = 500 VDC	1 = Copper (std. for non-hermetic) 2 = Nickel Iron (std.) 3 = Special 4 = Aluminum compatible with seating flange (std. lead) 5 = Aluminum compatible with seating flange (special lead) D = Aluminum compatible with centering flange (std. lead) E = Aluminum compatible with centering flange (special lead) F = Aluminum compatible special design Y = Solder	B = Class B S = Class S		

*Glass Seal Orientation:
 S = Standard
 R = Reverse
 N = No Glass (Epoxy both Sides)
 M = Mid Flange

Style	Capacitance Range (in pF if not indicated)					Current Rating	Circuit Available
	50VDC	100VDC	200VDC/115VAC	400VDC/230VAC	500VDC		
ZXS	5-5,600	5-1,800	5-1,000	-	-	1.5A	C
ZYS	5-22,000	5-8,200	5-4,700	5-2,700	-	2.5A	C
ZZS	5-27,000	5-10,000	5-5,600	5-3,300	5-1,800	5A	C, L
ZZ	5-27,000	5-10,000	5-5,600	5-3,300	5-1,800	5A	C
ZS/ZR	5-33,000	5-12,000	5-6,800	5-3,900	5-2,200	5A	C, L
YS/YR	5-68,000	5-27,000	5-18,000	5-10,000	5-6,800	5A	C, L
XS/XR	5pF-.39µF	5pF-.15µF	5pF-.1µF	5pF-.056µF	5pF-.033µF	10A	C, L
WS/WR	5pF-1.8µF	5pF-.68µF	5pF-.39µF	5pF-.22µF	5pF-.15µF	15A	C, L



AVX bolt-in style Pi filters, utilize discoidal capacitor technology to provide effective attenuation in the RF to microwave frequency spectrum from 10MHz to 26GHz.

Some versions offer large hex sizes which mean much higher capacitance levels are available and that a 125 VAC/400Hz rating can be offered for certain values.

In the “L” section version an internal ferrite bead element provides both inductance and series resistance which improves insertion loss and provides superior transient performance. They are ideal for filtering signal/data lines of high impedance source and load systems. These filters are designed to be mounted in a tapped bulkhead or with a standard nut and lock-washer provided.

CHARACTERISTICS (Varies with series)

- Miniature and Subminiature versions available
- Rugged monolithic discoidal capacitor construction
- Epoxy seal at both ends
- Conservatively rated for 125VAC/400Hz
- Pi design offers steeper insertion loss
- NASA SSQ 21215-21218

Check for up-to-date CV Tables at <http://www.avx.com/docs/catalogs/sbbolt.pdf>

HOW TO ORDER

SB
T
Style
SXD = 1-64 Epoxy Sealed
SYD = 2-56 Epoxy Sealed
SZD = 2-56 Epoxy Sealed
SA = 4-40 Epoxy Sealed
SG = 6-32 Epoxy Sealed
SB = 8-32 Epoxy Sealed
SM = 8-32 Hermetic Sealed
SH = 10-32 Epoxy Sealed
SJ = 12-28 Epoxy Sealed
SC = 12-32 Epoxy Sealed
(.187 HEX)
SP = 12-32 Epoxy Sealed
(.250 HEX)
SN = 12-32 Hermetic Sealed
SL = ¼-28 Epoxy Sealed
SD = 5/16-24 Epoxy Sealed
SF = 5/16-32 Epoxy Sealed

2
T
Circuit
1 = Feed Thru (C)
2 = L-Section (L)
3 = Pi-Section (π)
8 = Grounded Feed Thru

A
T
Voltage Rating
A = 100 VDC
B = 200 VDC
C = 50 VDC
F = 500 VDC
G = 1000 VDC
H = 150 VDC
J = 600 VDC
K = 250 VDC
L = 200 VDC/125 VAC
M = 350 VDC
N = 70 VDC
X = 500 VDC
Y = 300 VDC

1
T
Options
1 = Copper
2 = Steel
3 = Special Lead Design
4 = Beryllium Copper
G = Olean Exact Equivalent

-
T
MIL-28861 Screening
B = Class B
S = Class S

103
T
3 Digit Capacitor Code (in pF)

Style	Capacitance Range (in pF if not indicated)					Current Rating	Circuit Available
	50VDC	100VDC	200VDC/115VAC	400VDC/230VAC	500VDC		
SXD	5-5,600	5-1,800	5-1,000	-	-	3A	C, L
SYD	5-6,200	5-2,200	5-1,200	-	-	3A	C, L
SZD	5-22,000	5-8,200	5-4,700	5-2,700	-	5A	C, L
SA	5-33,000	5-12,000	5-6,800	5-3,900	5-2,200	5A	C, L
SG	5-33,000	5-12,000	5-6,800	5-3,900	5-2,200	5A	C, L
SB/SM	5-33,000	5-12,000	5-6,800	5-3,900	5-2,200	10A	C, L, π
SH	5pF-.33 μ F	5pF-.12 μ F	5pF-.082 μ F	5pF-.047 μ F	5pF-.027 μ F	10A	C, L, π
SJ/SC/SP/SN	5pF-.33 μ F	5pF-.12 μ F	5pF-.082 μ F	5pF-.047 μ F	5pF-.027 μ F	10A	C, L, π
SL/SD/SF	5pF-1.5 μ F	5pF-.56 μ F	5pF-.39 μ F	5pF-.22 μ F	5pF-.12 μ F	25A	C, L, π



AVX cylindrical style EMI filters offer effective filtering from 14KHz to 10GHz. Sealing options include epoxy sealed at both ends to optimize volumetric efficiency and cost, and a glass to metal hermetic seal version for severe moisture environments. They are designed for bulkhead mounting in a slotted hole with a nut and lockwasher supplied. These are ideal for low to medium impedance circuits where large amounts of capacitance to ground can be tolerated. In the "L" section version, an internal wound toroidal or ferrite bead element provides both inductance and series resistance which improves insertion loss at lower current ratings as well as superior transient performance.

CHARACTERISTICS (Varies with series)

- High DC current rating up to 25A
- Impervious to high moisture, solvents and other severe environmental conditions
- High capacitance values
- A 230VAC "T" section can handle very high pulse currents
- NASA SSQ 21215-21218

[Check for up-to-date CV Tables at http://www.avx.com/docs/catalogs/gkcyl.pdf](http://www.avx.com/docs/catalogs/gkcyl.pdf)

HOW TO ORDER

G T	K T	2 T	A T	A T	- T	S07	X T
Basic Style	Thread Type	Circuit	Voltage	Thread Length	MIL-28861 Screening		Plating Finish
A = Button Type (.410 Dia.) B = Button Type (.375 Dia.) C = Extended Button G = .375 Dia. J = .690 Dia. H = .410 Dia. Q = Special	K = 1/4-28 Herm. Seal L = 1/4-28 Epoxy Seal M = 8-32 Herm. Seal N = 12-32 Herm. Seal T = 1/4-28 Post Terminal (Both Ends) V = 1/4-28 Post and Flag Terminal X = 1/4-28 Hex Adapter Y = 5/8-24 Epoxy Sealed D = 5/16-24 F = 5/16-32 Z = Special	0 = Feed Thru Lead (Without Capacitor) 1 = Feed Thru Capacitor 2 = L-Section Filter 3 = PI Filter 4 = T-Section 5 = Double L-Section Cap Input 6 = Five Element IND Input 7 = Five Element IND Input 8 = Grounded Feed Thru	A = 100 VDC B = 200 VDC C = 50 VDC E = 400 VDC/230 VAC F = 500 VDC G = 1000 VDC H = 150 VDC J = 600 VDC K = 250 VDC L = 200 VDC/125 VAC (EXCEPT JD SERIES 300 VDC/125 VAC) M = 350 VDC N = 70 VDC X = 500 VDC Y = 300 VDC W = 400 VDC	A = .187 B = .312 C = Special	B = Class B S = Class S		G = Gold S = Silver

XXX	Circuit	Current Rating																																				
Capacitance in Picofarads	S = Standard L (Inductor on Thread End) R = Reverse L (Capacitor at Thread End) P = PI Circuit T = T Circuit	<table border="1"> <thead> <tr> <th>Code</th> <th>Current</th> <th>Code</th> <th>Current</th> </tr> </thead> <tbody> <tr><td>01</td><td>.06 Amp</td><td>09</td><td>2</td></tr> <tr><td>02</td><td>.1</td><td>10</td><td>3</td></tr> <tr><td>03</td><td>.15</td><td>11</td><td>5</td></tr> <tr><td>04</td><td>.25</td><td>12</td><td>10</td></tr> <tr><td>05</td><td>.3</td><td>16</td><td>4</td></tr> <tr><td>06</td><td>.45</td><td>17</td><td>6</td></tr> <tr><td>07</td><td>.5</td><td>18</td><td>.75</td></tr> <tr><td>08</td><td>1</td><td>19</td><td>1.5</td></tr> </tbody> </table>	Code	Current	Code	Current	01	.06 Amp	09	2	02	.1	10	3	03	.15	11	5	04	.25	12	10	05	.3	16	4	06	.45	17	6	07	.5	18	.75	08	1	19	1.5
Code	Current	Code	Current																																			
01	.06 Amp	09	2																																			
02	.1	10	3																																			
03	.15	11	5																																			
04	.25	12	10																																			
05	.3	16	4																																			
06	.45	17	6																																			
07	.5	18	.75																																			
08	1	19	1.5																																			

Style	Capacitance Range					Current Rating	Circuit Available
	50VDC	100VDC	200VDC/115VAC	400VDC/230VAC	500VDC		
BL	5pF-1.5µF	5pF-.56µF	5pF-.39µF	5pF-.22µF	5pF-.12µF	15A	C, L
BK	5pF-1.5µF	5pF-.56µF	5pF-.39µF	5pF-.22µF	5pF-.12µF	15A	C, L
AK	5pF-1.8µF	5pF-.68µF	5pF-.39µF	5pF-.27µF	5pF-.15µF	15A	C, L
CK	5pF-1.5µF	5pF-.56µF	5pF-.39µF	5pF-.22µF	5pF-.12µF	15A	C, L
GK	5pF-1.5µF	5pF-.56µF	5pF-.39µF	5pF-.22µF	5pF-.12µF	Up to 15A	C, L, π, T
HK	5pF-1.8µF	5pF-.68µF	5pF-.39µF	5pF-.27µF	5pF-.15µF	Up to 15A	C, L, π, T
JD	5pF-1.8µF	5pF-.68µF	5pF-.39µF	5pF-.27µF	5pF-.15µF	Up to 15A	C, L, π, T



AVX filters has expanded its portfolio of custom and customized filters and filter plates/filter assemblies. These designs are suitable for use in low frequency to high frequency applications and can be configured in a variety of capacitive and inductive filter elements. Also available are high current assemblies and filter assemblies that are geared toward harsh environments such as high temperature, high shock and vibration. All of these solutions are ideal for industrial, avionic, downhole exploration and space level applications.

HOW TO ORDER

MFB	007	Q	-	001	T1	XX
Bracket Array	Number of Filters 001 - 999	Hermeticity Q = Hermetic (Glass Both Sides) H = Hermetic (Glass One Side) N = No Hermeticity Requirements		Customer Dash Number*	Customer ID Code	Customer Drawing

Feedthru 0805/1206 Capacitors

W2F/W3F Series

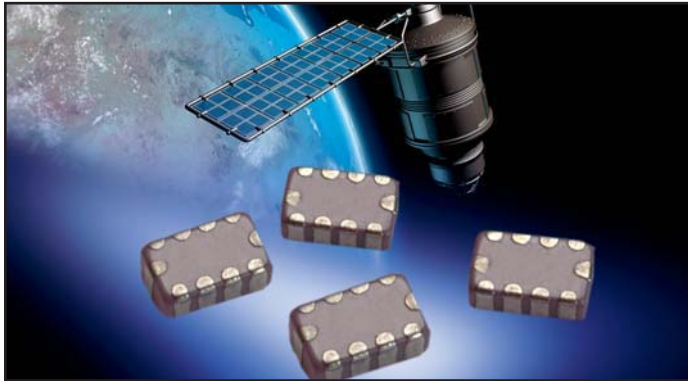

GENERAL DESCRIPTION

Available in both a standard 0805 and 1206 size, AVX's line of feedthru capacitors are ideal choices for EMI suppression, broadband I/O filtering, or Vcc power line conditioning. The unique construction of a feedthru capacitor provides low parallel inductance and offers excellent decoupling capability for all high di/dt environments and provides significant noise reduction in digital circuits to <5 GHz. A large range of capacitor values are available in either NPO or X7R ceramic dielectrics.

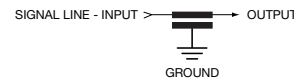

Check for up-to-date CV Tables at
<http://www.avx.com/docs/catalogs/w2f-w3f.pdf>

HOW TO ORDER

Style	Size	Feedthru	Number of Elements	Voltage*	Dielectric	Capacitance Code	Capacitance Tolerance	Failure Rate	Terminations	Packaging Code (Reel Size)	Quantity Code (Pcs./Reel)
W	3	F	1	5	C	223	8	A	T	3	A
2=0805 3=1206				1=100v 5=50v	A=NPO C=X7R		8=+50/-20%	A=Not Applicable	T=Plated	1=7" Reel Embossed Tape 3=13" Reel Embossed Tape	F=1,000 A=2,000, 4,000 or 10,000

*Note: NPO available in 100V only and X7R available in 50V only.

PERFORMANCE CHARACTERISTICS

	NPO	X7R
Capacitance Tolerance	+50%, -20%	+50%, -20%
Voltage Rating	100V	50V
Current Rating	300mA	300mA
Insulation Resistance	1000MΩ	1000MΩ
DC Resistance	<0.6Ω	<0.6Ω
Operating Temperature Range	-55 to +125°C	

CAPACITOR VALUES

Part Number	Size	Voltage	Dielectric	Capacitance
W2F11A 220 8ATxx	0805	100V	NPO	22pF
W2F11A 470 8ATxx	0805	100V	NPO	47pF
W2F11A 101 8ATxx	0805	100V	NPO	100pF
W2F11A 221 8ATxx	0805	100V	NPO	220pF
W2F11A 471 8ATxx	0805	100V	NPO	470pF
W2F15C 102 8ATxx	0805	50V	X7R	1000pF
W2F15C 222 8ATxx	0805	50V	X7R	2200pF
W2F15C 472 8ATxx	0805	50V	X7R	4700pF
W2F15C 103 8ATxx	0805	50V	X7R	10000pF
W2F15C 223 8ATxx	0805	50V	X7R	22000pF
W2F15C 473 8ATxx	0805	50V	X7R	47000pF
W3F11A 220 8ATxx	1206	100V	NPO	22pF
W3F11A 470 8ATxx	1206	100V	NPO	47pF
W3F11A 101 8ATxx	1206	100V	NPO	100pF
W3F11A 221 8ATxx	1206	100V	NPO	220pF
W3F11A 471 8ATxx	1206	100V	NPO	470pF
W3F15C 102 8ATxx	1206	50V	X7R	1000pF
W3F15C 222 8ATxx	1206	50V	X7R	2200pF
W3F15C 472 8ATxx	1206	50V	X7R	4700pF
W3F15C 103 8ATxx	1206	50V	X7R	10000pF
W3F15C 223 8ATxx	1206	50V	X7R	22000pF
W3F15C 473 8ATxx	1206	50V	X7R	47000pF

High Current Feedthru Filter

W2H/W3H Series



High current feedthru capacitors are designed as a broadband EMI filter that is specially structured to have high current handling capability. These SMT feedthru filters offer an optimized frequency response with high attenuation across a wide RF spectrum due to optimized parallel and series inductances. These W2H/W3H feedthru filters can actually replace discrete L/C filter networks.

Check for up-to-date CV Tables at
<http://www.avx.com/docs/catalogs/w2h-w3h.pdf>

HOW TO ORDER

W2H1	5	C	473	8	A	T	1A
Size & Style W2H1=0805 W3H1=0612	Voltage 3 = 25V 5 = 50V 1 = 100V	Dielectric A = NP0 C = X7R	Capacitance Code	Capacitance Tolerance 8 = +50/-20% M = ±20%	Failure Rate A=Not Applicable	Terminations T = Plated Ni And Sn	Packaging 1A = 7" Reel 4000 pcs 3A = 13" Reel 4000 pcs

ELECTRICAL PARAMETERS

Insulation Resistance	1000 mOhms Minimum
DC Resistance	<150 mOhms
Operating Temperature	-55C to +125C

CAPACITOR VALUES

Part Number	Size	Dielectric	Capacitance	Tolerance	Voltage	Current
W2H13C 104 8AT	0805	X7R	100,000pF	+50%, -20%	25V	2A
W2H15C 473 8AT	0805	X7R	47,000pF	+50%, -20%	50V	2A
W2H15C 223 8AT	0805	X7R	22,000pF	+50%, -20%	50V	1A
W2H15C 103 8AT	0805	X7R	10,000pF	+50%, -20%	50V	1A
W2H15C 102 8AT	0805	X7R	1,000pF	+50%, -20%	50V	1A
W2H11A 471 8AT	0805	NP0	470pF	+50%, -20%	100V	0.5A
W2H11A 221 8AT	0805	NP0	220pF	+50%, -20%	100V	0.5A
W2H11A 101 8AT	0805	NP0	100pF	+50%, -20%	100V	0.5A
W2H11A 470 8AT	0805	NP0	47pF	+50%, -20%	100V	0.5A
W2H11A 220 8AT	0805	NP0	22pF	+50%, -20%	100V	0.5A
W3H13C 104 8AT	0612	X7R	100,000pF	+50%, -20%	25V	up to 5A
W3H15C 473 8AT	0612	X7R	47,000pF	+50%, -20%	50V	up to 5A
W3H15C 223 8AT	0612	X7R	22,000pF	+50%, -20%	50V	up to 4A
W3H15C 103 8AT	0612	X7R	10,000pF	+50%, -20%	50V	up to 3A
W3H11A 471 8AT	0612	NP0	470pF	+50%, -20%	100V	up to 4A
W3H11A 221 8AT	0612	NP0	220pF	+50%, -20%	100V	up to 4A
W3H11A 101 8AT	0612	NP0	100pF	+50%, -20%	100V	up to 4A
W3H11A 470 8AT	0612	NP0	47pF	+50%, -20%	100V	up to 3A
W3H11A 220 8AT	0612	NP0	22pF	+50%, -20%	100V	up to 3A

Tin/Lead Feedthru 0805/1206 Capacitors

L2F/L3F Series

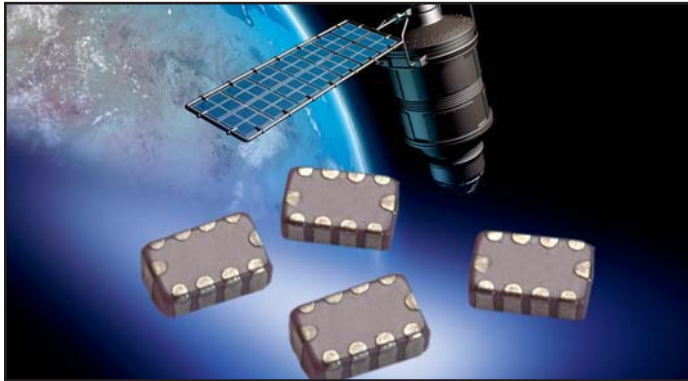

GENERAL DESCRIPTION

Available in both a standard 0805 and 1206 size, AVX's line of feedthru capacitors are ideal choices for EMI suppression, broadband I/O filtering, or Vcc power line conditioning. The unique construction of a feedthru capacitor provides low parallel inductance and offers excellent decoupling capability for all high di/dt environments and provides significant noise reduction in digital circuits to <5 GHz. A large range of capacitor values are available in either NPO or X7R ceramic dielectrics.

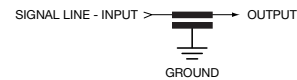

Check for up-to-date CV Tables at www.avx.com/docs/catalogs/l2f-l3f.pdf

HOW TO ORDER

Style	Size	Feedthru of Elements	Number of Elements	Voltage*	Dielectric	Capacitance Code	Capacitance Tolerance	Failure Rate	Terminations	Packaging Code (Reel Size)	Quantity Code (Pcs./Reel)
L	3	F	1	5	C	223	8	A	B	3	A
2=0805 3=1206				1=100v 5=50v	A=NPO C=X7R		8=+50/-20%	A=Not Applicable	B=Tin/Lead min 5%	1=7" Reel Embossed Tape 3=13" Reel Embossed Tape	F=1,000 A=2,000, 4,000 or 10,000

*Note: NPO available in 100V only and X7R available in 50V only.

PERFORMANCE CHARACTERISTICS

	NPO	X7R
Capacitance Tolerance	+50%, -20%	+50%, -20%
Voltage Rating	100V	50V
Current Rating	300mA	300mA
Insulation Resistance	1000MΩ	1000MΩ
DC Resistance	<0.6Ω	<0.6Ω
Operating Temperature Range	-55 to +125°C	

CAPACITOR VALUES

Part Number	Size	Voltage	Dielectric	Capacitance
L2F11A 220 8ATxx	0805	100V	NPO	22pF
L2F11A 470 8ATxx	0805	100V	NPO	47pF
L2F11A 101 8ATxx	0805	100V	NPO	100pF
L2F11A 221 8ATxx	0805	100V	NPO	220pF
L2F11A 471 8ATxx	0805	100V	NPO	470pF
L2F15C 102 8ATxx	0805	50V	X7R	1000pF
L2F15C 222 8ATxx	0805	50V	X7R	2200pF
L2F15C 472 8ATxx	0805	50V	X7R	4700pF
L2F15C 103 8ATxx	0805	50V	X7R	10000pF
L2F15C 223 8ATxx	0805	50V	X7R	22000pF
L2F15C 473 8ATxx	0805	50V	X7R	47000pF
L3F11A 220 8ATxx	1206	100V	NPO	22pF
L3F11A 470 8ATxx	1206	100V	NPO	47pF
L3F11A 101 8ATxx	1206	100V	NPO	100pF
L3F11A 221 8ATxx	1206	100V	NPO	220pF
L3F11A 471 8ATxx	1206	100V	NPO	470pF
L3F15C 102 8ATxx	1206	50V	X7R	1000pF
L3F15C 222 8ATxx	1206	50V	X7R	2200pF
L3F15C 472 8ATxx	1206	50V	X7R	4700pF
L3F15C 103 8ATxx	1206	50V	X7R	10000pF
L3F15C 223 8ATxx	1206	50V	X7R	22000pF
W3F15C 473 8ATxx	1206	50V	X7R	47000pF

Tin/Lead High Current Feedthru Filter

L2H/L3H Series



High current feedthru capacitors are designed as a broadband EMI filter that is specially structured to have high current handling capability. These SMT feedthru filters offer an optimized frequency response with high attenuation across a wide RF spectrum due to optimized parallel and series inductances. These W2H/W3H feedthru filters can actually replace discrete L/C filter networks.

[Check for up-to-date CV Tables at
http://www.avx.com/docs/catalogs/l2h-l3h.pdf](http://www.avx.com/docs/catalogs/l2h-l3h.pdf)

HOW TO ORDER

L2H1	5	C	473	8	A	B	1A
↑	↑	↑	↑	↑	↑	↑	↑
Size & Style L2H1 = 0805 L3H1 = 0612	Voltage 3 = 25V 5 = 50V 1 = 100V	Dielectric A = NP0 C = X7R	Capacitance Code	Capacitance Tolerance 8 = +50/-20% M = ±20%	Failure Rate A = Not Applicable	Terminations B = Tin/Lead min 5% Lead	Packaging 1A = 7" Reel 4000 pcs 3A = 13" Reel 4000 pcs

ELECTRICAL PARAMETERS

Insulation Resistance	1000 mOhms Minimum
DC Resistance	<150 mOhms
Operating Temperature	-55C to +125C

CAPACITOR VALUES

Part Number	Size	Dielectric	Capacitance	Tolerance	Voltage	Current
L2H13C 104 8AB	0805	X7R	100,000pF	+50%, -20%	25V	2A
L2H15C 473 8AB	0805	X7R	47,000pF	+50%, -20%	50V	2A
L2H15C 223 8AB	0805	X7R	22,000pF	+50%, -20%	50V	1A
L2H15C 103 8AB	0805	X7R	10,000pF	+50%, -20%	50V	1A
L2H15C 102 8AB	0805	X7R	1,000pF	+50%, -20%	50V	1A
L2H11A 471 8AB	0805	NP0	470pF	+50%, -20%	100V	0.5A
L2H11A 221 8AB	0805	NP0	220pF	+50%, -20%	100V	0.5A
L2H11A 101 8AB	0805	NP0	100pF	+50%, -20%	100V	0.5A
L2H11A 470 8AB	0805	NP0	47pF	+50%, -20%	100V	0.5A
L2H11A 220 8AB	0805	NP0	22pF	+50%, -20%	100V	0.5A
L3H13C 104 8AB	0612	X7R	100,000pF	+50%, -20%	25V	up to 5A
L3H15C 473 8AB	0612	X7R	47,000pF	+50%, -20%	50V	up to 5A
L3H15C 223 8AB	0612	X7R	22,000pF	+50%, -20%	50V	up to 4A
L3H15C 103 8AB	0612	X7R	10,000pF	+50%, -20%	50V	up to 3A
L3H11A 471 8AB	0612	NP0	470pF	+50%, -20%	100V	up to 4A
L3H11A 221 8AB	0612	NP0	220pF	+50%, -20%	100V	up to 4A
L3H11A 101 8AB	0612	NP0	100pF	+50%, -20%	100V	up to 4A
L3H11A 470 8AB	0612	NP0	47pF	+50%, -20%	100V	up to 3A
L3H11A 220 8AB	0612	NP0	22pF	+50%, -20%	100V	up to 3A

Feedthru Array Filters – W2F4/W3F4 Series

EMI Filtering, Broadband Filtering, LCD Filtering



Available in a 4-Element 0508 and 0612 Feedthru Array package, AVX's line of Feedthrus is an ideal choice for EMI suppression, broadband I/O filtering, LCD filtering and V_{CC} power line conditioning. The unique construction of the Feedthru capacitor provides low parallel inductance and offers excellent decoupling capability for all high di/dt environments and provides significant noise reduction in digital circuits up to 5 GHz. A range of filtering characteristics is available. The Feedthru Array contains four elements with a common ground connection, making it an ideal choice for multi-line designs. Additional benefits of the multi-element array package are reduced placement costs, reduced component counts and PCB space savings. Feedthru filters can be used to meet IEC, MIL-STD-461E, FCC, and SAE radiated and conducted emission requirements.

Check for up-to-date CV Tables at <http://www.avx.com/docs/catalogs/w2f4-w3f4.pdf>

FREQUENCY CHARACTERISTICS

Part Number	Roll Off Frequency	Center Frequency	10 db Point	20 db Range	
W3F41A2208AT	270 MHz	2640 MHz	970 MHz	1780 MHz	3500 MHz
W3F41A4708AT	65 MHz	2000 MHz	185 MHz	600 MHz	3400 MHz
W3F41A1018AT	65 MHz	2030 MHz	185 MHz	560 MHz	3500 MHz
W3F45C2218AT	35 MHz	1885 MHz	120 MHz	470 MHz	3300 MHz
W3F45C4718AT	20 MHz	1860 MHz	60 MHz	220 MHz	3500 MHz
W2F43A2208AT	208 MHz	4750 MHz	616 MHz	1407 MHz	7300 MHz
W2F43A4708AT	110 MHz	2750 MHz	330 MHz	900 MHz	4600 MHz
W2F43A1018AT	60 MHz	1300 MHz	179 MHz	501 MHz	7200 MHz

CAPACITOR VALUES & PERFORMANCE CHARACTERISTICS

Part Number	Typical Capacitance	Insulation Resistance	Temperature Characteristics
W3F41A2208AT	22pF	> 1000 M _Ω	NPO
W3F41A4708AT	47pF	> 1000 M _Ω	NPO
W3F41A1018AT	100pF	> 1000 M _Ω	NPO
W3F45C2218AT	220pF	> 1000 M _Ω	X7R
W3F45C4718AT	470pF	> 1000 M _Ω	X7R
W2F43A2208AT	22pF	> 1000 M _Ω	NPO
W2F43A4708AT	47pF	> 1000 M _Ω	NPO
W2F43A1018AT	100pF	> 1000 M _Ω	NPO

CASE SIZE & VOLTAGE RATINGS

Part Number	Case Size	Current Rating	DC Resistance	Voltage Rating
W3F41A2208AT W3F41A4708AT W3F41A1018AT	0612	300 mA	< 0.6 _Ω	100 V
W3F45C2218AT W3F45C4718AT	0612	300 mA	< 0.6 _Ω	50 V
W2F43A2208AT W2F43A4708AT W2F43A1018AT	0508	50 mA	< 3.0 _Ω	25 V



APPLICATIONS

DC voltage filtering for:

- DC link
- Resonant filtering
- Active correction (FACTS, UPFC, DVR...)
- Speed converters (drives and traction)
- Windmills
- Substation

PACKAGING

Rectangular stainless steel case sandblasted. Grounding is via a threaded screw located on the cover of the case.



Check for up-to-date CV Tables at
<http://www.avx.com/docs/catalogs/filmcaps.pdf>

PART NUMBER / HOW TO ORDER

D	K	T	F	M	1	B	M	B	5	8	5	7
					Section and Option	Terminal Type	Fixing	Voltage	Capacitance			
					1 340x117 2 terminals 2 340x117 4 terminals 3 340x165 2 terminals 4 340x165 4 terminals	A, B, C or D See drawings	W=without M=brackets	A = 1200 to 1500V B = 1850V C = 2000V D = 2250V E = 2500V F = 2750V G = 3000V	H = 3500V I = 4000V J = 4500V K = 5000V L = 5500V M = 6000V	EIA Code		

ELECTRICAL CHARACTERISTICS – STANDARD PRODUCTS

Capacitance range C_n	610 μ F to 15600 μ F
Tolerance on C_n	$\pm 10\%$
DC voltage range	1200V to 5000V
Maximum hot-spot temperature	85°C
Life duration at nominal voltage and 70°C hot-spot temperature	100000 hours
Stray inductance	<400nH
Test voltage between terminals	1.5V _n during 10s
Test voltage between short terminals and case	10kV _{rms} (at 50Hz during 1mn)
Standard reference	Conforms with IEC 61071 and 61881, 61373, 60068 and 60077

ELECTRICAL CHARACTERISTICS – CUSTOM PRODUCTS

Capacitance range C_n	83 μ F to 15300 μ F
Tolerance on C_n ($\pm 5\%$ or $\pm 2\%$ available for specific requirements)	$\pm 10\%$
DC voltage range	1200V to 6000V
Maximum hot-spot temperature	85°C
Life duration at nominal voltage and 70°C hot-spot temperature	100,000 hours
Stray inductance	200nH to 430nH
On option low inductance for IGBT and other applications	down to 40nH
Test voltage between terminals	1.5V _n during 10s
Test voltage between short terminals and case	10kV _{rms} (at 50Hz during 1mn)
Standard reference	Conforms with IEC 61071, 61881 and 61373, IEC 60068 and IEC 60077

TABLE OF VALUES

Base 340mm x 117mm (Length x Width)

Height millimeters (inches)	$V_n = 1200$ to $1500V$			$V_n = 1850V$		
	C (μF)	R_s (m Ω)	Part Number	C (μF)	R_s (m Ω)	Part Number
215 (8.465)	1900	0.60	DKTFMXXXA1907	1420	0.64	DKTFMXXXB1427
290 (11.42)	2850	0.48	DKTFMXXXA2857	2140	0.49	DKTFMXXXB2147
365 (14.37)	3800	0.42	DKTFMXXXA3807	2850	0.42	DKTFMXXXB2857
440 (17.32)	4750	0.39	DKTFMXXXA4757	3560	0.38	DKTFMXXXB3567
515 (20.28)	5700	0.37	DKTFMXXXA5707	4270	0.36	DKTFMXXXB4277
590 (23.23)	6750	0.36	DKTFMXXXA6757	4980	0.35	DKTFMXXXB4987
705 (27.76)	8100	0.35	DKTFMXXXA8107	6050	0.33	DKTFMXXXB6057
815 (32.09)	9500	0.34	DKTFMXXXA9507	7120	0.32	DKTFMXXXB7127

Height millimeters (inches)	$V_n = 2000V$			$V_n = 2250V$		
	C (μF)	R_s (m Ω)	Part Number	C (μF)	R_s (m Ω)	Part Number
215 (8.465)	1260	0.67	DKTFMXXXC1267	1000	0.73	DKTFMXXXD1007
290 (11.42)	1880	0.51	DKTFMXXXC1887	1500	0.55	DKTFMXXXD1507
365 (14.37)	2510	0.44	DKTFMXXXC2517	2000	0.47	DKTFMXXXD2007
440 (17.32)	3140	0.40	DKTFMXXXC3147	2500	0.42	DKTFMXXXD2507
515 (20.28)	3770	0.37	DKTFMXXXC3777	3000	0.39	DKTFMXXXD3007
590 (23.23)	4400	0.36	DKTFMXXXC4407	3500	0.37	DKTFMXXXD3507
705 (27.76)	5340	0.34	DKTFMXXXC5347	4250	0.36	DKTFMXXXD4257
815 (32.09)	6280	0.33	DKTFMXXXC6287	5000	0.35	DKTFMXXXD5007

Height millimeters (inches)	$V_n = 2500V$			$V_n = 2750V$		
	C (μF)	R_s (m Ω)	Part Number	C (μF)	R_s (m Ω)	Part Number
215 (8.465)	810	0.79	DKTFMXXXE0817	675	0.86	DKTFMXXXF6756
290 (11.42)	1220	0.60	DKTFMXXXE1227	1010	0.64	DKTFMXXXF1017
365 (14.37)	1620	0.50	DKTFMXXXE1627	1350	0.53	DKTFMXXXF1357
440 (17.32)	2030	0.44	DKTFMXXXE2037	1680	0.47	DKTFMXXXF1687
515 (20.28)	2440	0.41	DKTFMXXXE2447	2020	0.44	DKTFMXXXF2027
590 (23.23)	2840	0.39	DKTFMXXXE2847	2360	0.41	DKTFMXXXF2367
705 (27.76)	3450	0.37	DKTFMXXXE3457	2860	0.39	DKTFMXXXF2867
815 (32.09)	4060	0.36	DKTFMXXXE4067	3370	0.37	DKTFMXXXF3377

Height millimeters (inches)	$V_n = 3000V$			$V_n = 3500V$		
	C (μF)	R_s (m Ω)	Part Number	C (μF)	R_s (m Ω)	Part Number
215 (8.465)	570	0.92	DKTFMXXXG0577	365	0.62	DKTFMXXXH3656
290 (11.42)	850	0.68	DKTFMXXXG0857	545	0.48	DKTFMXXXH5456
365 (14.37)	1140	0.56	DKTFMXXXG1147	730	0.41	DKTFMXXXH0737
440 (17.32)	1420	0.50	DKTFMXXXG1427	910	0.38	DKTFMXXXH0917
515 (20.28)	1700	0.46	DKTFMXXXG1707	1090	0.35	DKTFMXXXH1097
590 (23.23)	1990	0.43	DKTFMXXXG1997	1280	0.34	DKTFMXXXH1287
705 (27.76)	2410	0.40	DKTFMXXXG2417	1550	0.33	DKTFMXXXH1557
815 (32.09)	2840	0.39	DKTFMXXXG2847	1820	0.32	DKTFMXXXH1827

TABLE OF VALUES

Base 340mm x 165mm (Length x Width)

Height millimeters (inches)	$V_n = 1200$ to $1500V$			$V_n = 1850V$		
	C (μF)	R_s (m Ω)	Part Number	C (μF)	R_s (m Ω)	Part Number
215 (8.465)	3100	0.78	DKTFMXXXA3107	2110	0.92	DKTFMXXXB2117
290 (11.42)	4630	0.60	DKTFMXXXA4637	3170	0.69	DKTFMXXXB3177
365 (14.37)	6200	0.52	DKTFMXXXA6207	4230	0.58	DKTFMXXXB4237
440 (17.32)	7700	0.47	DKTFMXXXA7707	5290	0.52	DKTFMXXXB5297
515 (20.28)	9300	0.44	DKTFMXXXA9307	6340	0.48	DKTFMXXXB6347
590 (23.23)	10800	0.42	DKTFMXXXA1088	7400	0.46	DKTFMXXXB7407
705 (27.76)	13200	0.40	DKTFMXXXA1328	8980	0.43	DKTFMXXXB8987
815 (32.09)	15500	0.39	DKTFMXXXA1558	10600	0.42	DKTFMXXXB1068

Height millimeters (inches)	$V_n = 2000V$			$V_n = 2250V$		
	C (μF)	R_s (m Ω)	Part Number	C (μF)	R_s (m Ω)	Part Number
215 (8.465)	1680	1.00	DKTFMXXXC1687	1420	1.08	DKTFMXXXD1427
290 (11.42)	2520	0.75	DKTFMXXXC2527	2140	0.80	DKTFMXXXD2147
365 (14.37)	3360	0.63	DKTFMXXXC3367	2850	0.66	DKTFMXXXD2857
440 (17.32)	4200	0.56	DKTFMXXXC4207	3570	0.58	DKTFMXXXD3577
515 (20.28)	5040	0.51	DKTFMXXXC5047	4280	0.53	DKTFMXXXD4287
590 (23.23)	5880	0.48	DKTFMXXXC5887	5000	0.50	DKTFMXXXD5007
705 (27.76)	7140	0.45	DKTFMXXXC7147	6070	0.47	DKTFMXXXD6077
815 (32.09)	8400	0.44	DKTFMXXXC8407	7140	0.45	DKTFMXXXD7147

Height millimeters (inches)	$V_n = 2500V$			$V_n = 2750V$		
	C (μF)	R_s (m Ω)	Part Number	C (μF)	R_s (m Ω)	Part Number
215 (8.465)	1130	1.18	DKTFMXXXE1137	955	1.27	DKTFMXXXF9556
290 (11.42)	1700	0.87	DKTFMXXXE1707	1430	0.93	DKTFMXXXF1437
365 (14.37)	2260	0.71	DKTFMXXXE2267	1910	0.76	DKTFMXXXF1917
440 (17.32)	2830	0.63	DKTFMXXXE2837	2380	0.66	DKTFMXXXF2387
515 (20.28)	3400	0.57	DKTFMXXXE3407	2860	0.60	DKTFMXXXF2867
590 (23.23)	3950	0.53	DKTFMXXXE3957	3340	0.56	DKTFMXXXF3347
705 (27.76)	4820	0.49	DKTFMXXXE4827	4060	0.52	DKTFMXXXF4067
815 (32.09)	5670	0.47	DKTFMXXXE5677	4770	0.49	DKTFMXXXF4777

Height millimeters (inches)	$V_n = 3000V$			$V_n = 3500V$		
	C (μF)	R_s (m Ω)	Part Number	C (μF)	R_s (m Ω)	Part Number
215 (8.465)	800	1.37	DKTFMXXXG0807*	555	1.60	DKTFMXXXH5556*
290 (11.42)	1200	0.99	DKTFMXXXG1207	833	1.15	DKTFMXXXH8336
365 (14.37)	1600	0.81	DKTFMXXXG1607	1110	0.92	DKTFMXXXH1117
440 (17.32)	2000	0.70	DKTFMXXXG2007	1390	0.79	DKTFMXXXH1397
515 (20.28)	2400	0.63	DKTFMXXXG2407	1660	0.71	DKTFMXXXH1667
590 (23.23)	2800	0.59	DKTFMXXXG2807	1940	0.65	DKTFMXXXH1947
705 (27.76)	3400	0.54	DKTFMXXXG3407	2360	0.59	DKTFMXXXH2367
815 (32.09)	4000	0.51	DKTFMXXXG4007	2780	0.56	DKTFMXXXH2787

* see particular Rms current value on page 20

TABLE OF VALUES

Base 340mm x 165mm (Length x Width)

Height millimeters (inches)	$V_n = 4000V$			$V_n = 4500V$		
	C (μF)	R_s (m Ω)	Part Number	C (μF)	R_s (m Ω)	Part Number
215 (8.465)	438	1.78	DKTFMXXXI4386*	335	1.08	DKTFMXXXJ3356
290 (11.42)	657	1.26	DKTFMXXXI6576	503	0.80	DKTFMXXXJ5036
365 (14.37)	876	1.00	DKTFMXXXI8766	670	0.67	DKTFMXXXJ0677
440 (17.32)	1090	0.87	DKTFMXXXI1097	839	0.59	DKTFMXXXJ8396
515 (20.28)	1310	0.77	DKTFMXXXI1317	1000	0.54	DKTFMXXXJ1007
590 (23.23)	1530	0.70	DKTFMXXXI1537	1170	0.50	DKTFMXXXJ1177
705 (27.76)	1860	0.64	DKTFMXXXI1867	1420	0.47	DKTFMXXXJ1427
815 (32.09)	2190	0.59	DKTFMXXXI2197	1680	0.45	DKTFMXXXJ1687

Height millimeters (inches)	$V_n = 5000V$			$V_n = 5500V$		
	C (μF)	R_s (m Ω)	Part Number	C (μF)	R_s (m Ω)	Part Number
215 (8.465)	266	1.19	DKTFMXXXK2666	224	1.28	DKTFMXXXL2246
290 (11.42)	400	0.87	DKTFMXXXK0407	336	0.93	DKTFMXXXL3366
365 (14.37)	532	0.72	DKTFMXXXK5326	448	0.76	DKTFMXXXL4486
440 (17.32)	666	0.63	DKTFMXXXK6666	560	0.67	DKTFMXXXL0567
515 (20.28)	800	0.57	DKTFMXXXK0807	672	0.60	DKTFMXXXL6726
590 (23.23)	932	0.53	DKTFMXXXK9326	785	0.56	DKTFMXXXL7856
705 (27.76)	1130	0.50	DKTFMXXXK1137	953	0.52	DKTFMXXXL9536
815 (32.09)	1330	0.47	DKTFMXXXK1337	1120	0.49	DKTFMXXXL1127

Height millimeters (inches)	$V_n = 6000V$		
	C (μF)	R_s (m Ω)	Part Number
215 (8.465)	188	1.38	DKTFMXXXM1886*
290 (11.42)	282	1.00	DKTFMXXXM2826
365 (14.37)	376	0.81	DKTFMXXXM3766
440 (17.32)	470	0.70	DKTFMXXXM0477
515 (20.28)	564	0.64	DKTFMXXXM5646
590 (23.23)	659	0.59	DKTFMXXXM6596
705 (27.76)	800	0.54	DKTFMXXXM0807
815 (32.09)	940	0.51	DKTFMXXXM0947

* see particular Rms current value

Particular Rms Current Value	
Part Number	I_{rms} max (A)
DKTFMXXXG0807	244
DKTFMXXXH5556	204
DKTFMXXXI4386	181
DKTFMXXXM1886	244

Medium Power Film Capacitors

FFB (RoHS Compliant)

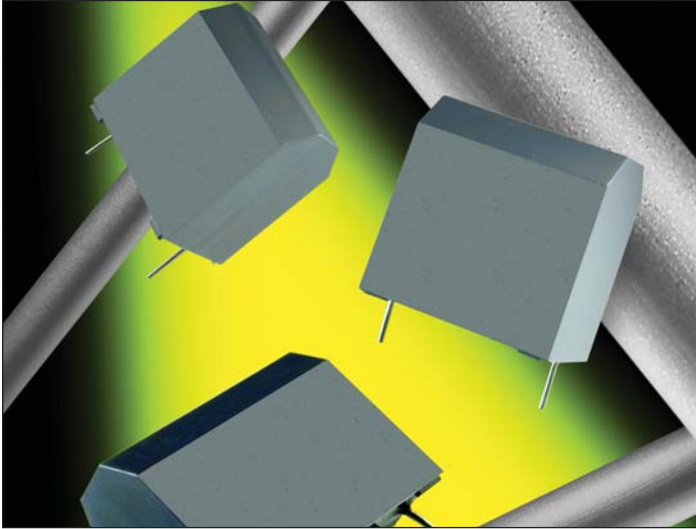

 Check for up-to-date CV Tables at
<http://www.avx.com/docs/catalogs/filmcaps.pdf>

PACKAGING MATERIAL

Self-extinguishing plastic case (V0 = in accordance with UL 94) filled thermosetting resin.

Self-extinguishing thermosetting resin (V0 = in accordance with UL 94; I3F2 = in accordance with NF F 16-101).

STANDARDS

- IEC 61071-1, IEC 61071-2: Power electronic capacitors
- IEC 60384-16: Fixed metallized polypropylene film dielectric DC capacitors
- IEC 60384-16-1: Fixed metallized polypropylene film dielectric DC capacitors Assessment level E
- IEC 60384-17: Fixed metallized polypropylene film dielectric AC and pulse capacitors
- IEC 60384-17-1: Fixed metallized polypropylene film dielectric AC and pulse capacitors Assessment level E
- IEC 60384-2: Fixed metallized polyester capacitors

HOW TO ORDER

FFB	1	4	D	0336	K	--
Series	Case Size	Dielectric	Voltage Code	Capacitance Code	Capacitance Tolerances	Lead Styles
	1 2 3 4 5	4 = Polyester 6 = Polypropylene	D = 75Vdc E = 100Vdc H = 300Vdc I = 400Vdc J = 525Vdc A = 720Vdc C = 900Vdc L = 1100Vdc	0 = pF code 0336 = 33µF 0686 = 68µF 0117 = 110µF etc.	K = ±10%	-- = 2 Leaded JC = 4 Leaded
						Consult Factory for Special Options

The FFB series uses a non-impregnated metallized polypropylene or polyester dielectric with the controlled self-healing process, specially treated to have a very high dielectric strength in operating conditions up to 105°C.

The FFB has been designed for printed circuit board mounting. Its performance allows the FFB to be a very interesting alternative to electrolytic technology as it can withstand much higher levels of surge voltage.

APPLICATIONS

The FFB capacitor is particularly designed for DC filtering, low reactive power.

HOT SPOT CALCULATION

See *Hot Spot Temperature*, page 3.

$$\theta_{\text{hot spot}} = \theta_{\text{ambient}} + (P_d + P_t) \times R_{\text{th}}$$

with P_d (Dielectric losses) = $Q \times \text{tg}\delta_0$
 $Q \times \text{tg}\delta_0 \Rightarrow [\frac{1}{2} \times C_n \times (V_{\text{peak to peak}})^2 \times f] \times \text{tg}\delta_0$
 $\text{tg}\delta_0$ (tan delta)

For polypropylene, $\text{tg}\delta_0 = 2 \times 10^{-4}$ for frequencies up to 1MHz and is independent of temperatures. For polyester, $\text{tg}\delta_0$ values are shown in graph 4 on page 3.

$$P_t \text{ (Thermal losses)} = R_s \times (I_{\text{rms}})^2$$

where C_n in Farad I_{rms} in Ampere f in Hertz
 V in Volt R_s in Ohm θ in °C
 R_{th} in °C/W

WORKING TEMPERATURE

(according to the power to be dissipated) -55°C to +105°C

LIFETIME EXPECTANCY

One unique feature of this technology (as opposed to electrolytics) is how the capacitor reacts at the end of its lifetime. Unlike aluminum, electrolytic film capacitors do not have a catastrophic failure mode. Film capacitors simply experience a parametric loss of capacitance of about 2%, with no risk of short circuit.

Please note that this is theoretical, however, as the capacitor continues to be functional even after this 2% decrease.

POLYESTER DIELECTRIC FOR LOW VOLTAGE DC FILTERING

ELECTRICAL CHARACTERISTICS – POLYESTER DIELECTRIC

Climatic category	55/105/56 (IEC 60068)
Test voltage between terminals @ 25°C	1.5 x $V_{n,dc}$
Capacitance range C_n	6.2 μ F to 110 μ F
Tolerance on C_n	\pm 10%
Rated DC voltage $V_{n,dc}$	75 to 400 V
Dielectric	polyester
Max Stray Inductance	20nH

LIFETIME EXPECTANCY vs VOLTAGE AND HOT SPOT TEMPERATURE – POLYESTER DIELECTRIC

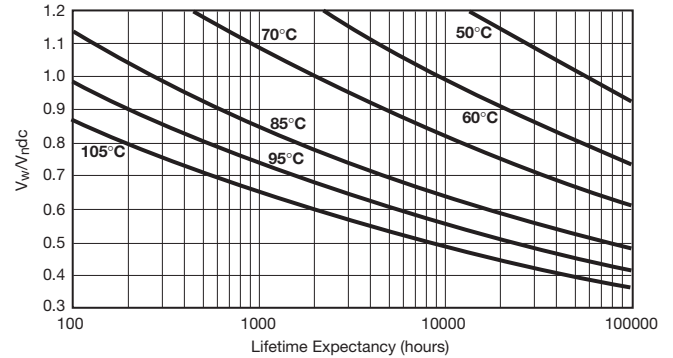

RATINGS AND PART NUMBER REFERENCE – POLYESTER DIELECTRIC

Part Number	Capacitance (μ F)	Case Style	I_{rms} max. (A)	R_s (m Ω)	R_{th} ($^{\circ}$ C/W)	Typical Weight (g)
$V_{n,dc}$ 75V Vrms max.: 45 volts Voltage Code: D						
FFB14D0336K--	33	PO	3	3	40.7	15
FFB24D0476K--	47	18	4.3	2	33.3	20
FFB34D0686K--	68	19	6.2	1.7	29.9	25
FFB44D0826K--	82	26	7.4	1.6	26.7	32
FFB54D0117K--	110	R68 (2 terminals)	10	1.4	22.9	40
FFB54D0117KJC	110	R68 (4 terminals)	10	1.4	22.9	40
$V_{n,dc}$ 100V Vrms max.: 60 volts Voltage Code: E						
FFB14E0206K--	20	PO	2.6	3	40.5	15
FFB24E0276K--	27	18	3.5	2.5	33.3	20
FFB34E0396K--	39	19	5	2	29.8	25
FFB44E0476K--	47	26	6	1.7	26.6	32
FFB54E0686K--	68	R68 (2 terminals)	9	1.4	22.8	40
FFB54E0686KJC	68	R68 (4 terminals)	9	1.4	22.8	40
$V_{n,dc}$ 300V Vrms max.: 90 volts Voltage Code: H						
FFB14H0755K--	7.5	PO	2.4	16	40.7	15
FFB24H0116K--	11	18	3.6	11	33.5	20
FFB34H0166K--	16	19	5.2	8	29.9	25
FFB44H0186K--	18	26	6	7	27.1	32
FFB54H0276K--	27	R68 (2 terminals)	9	5	22.9	40
FFB54H0276KJC	27	R68 (4 terminals)	9	5	22.9	40
$V_{n,dc}$ 400V Vrms max.: 105 volts Voltage Code: I						
FFB14I0625K--	6.2	PO	2.5	17	40.5	15
FFB24I0755K--	7.5	18	3.1	14	33.5	20
FFB34I0126K--	12	19	5	9	29.9	25
FFB44I0156K--	15	26	6.2	7	26.4	32
FFB54I0206K--	20	R68 (2 terminals)	8.2	5.5	22.8	40
FFB54I0206KJC	20	R68 (4 terminals)	8.2	5.5	22.8	40

Medium Power Film Capacitors

FFB (RoHS Compliant) – Polypropylene Dielectric



POLYPROPYLENE DIELECTRIC FOR INDUSTRIAL DC FILTERING

These capacitors have been designed principally for high and medium power DC filtering applications.

ELECTRICAL CHARACTERISTICS – POLYPROPYLENE DIELECTRIC

Climatic category	55/105/56 (IEC 60068)
Test voltage between terminals @ 25°C	1.5 x V _n dc
Capacitance range C _n	1.5µF to 13µF
Tolerance on C _n	±10%
Rated DC voltage V _n dc	525 to 1100 V
Dielectric	polypropylene

LIFETIME EXPECTANCY vs VOLTAGE AND HOT SPOT TEMPERATURE – POLYPROPYLENE DIELECTRIC

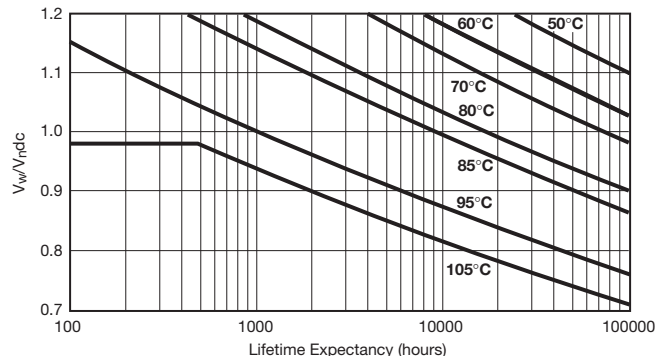

V_w = Working DC Voltage • V_n = Rated DC Voltage

RATINGS AND PART NUMBER REFERENCE – POLYPROPYLENE DIELECTRIC

Part Number	Capacitance (µF)	Case Style	I _{rms} max. (A)	R _s (mΩ)	R _{th} (°C/W)	Typical Weight (g)
V_ndc 525V Vrms max.: 105 volts Voltage Code: J						
FFB16J0395K--	3.9	PO	5.1	30	45.7	15
FFB26J0565K--	5.6	18	7.4	21	36.4	20
FFB36J0825K--	8.2	19	10.9	15	32.6	25
FFB46J0106K--	10	26	12	12	29.8	32
FFB56J0136K--	13	R68 (2 terminals)	12	9	24.3	40
FFB56J0136KJC	13	R68 (4 terminals)	16.7	9	24.3	40
V_ndc 720V Vrms max.: 120 volts Voltage Code: A						
FFB16A0335K--	3.3	PO	5.0	31	45.0	15
FFB26A0435K--	4.3	18	6.5	24	36.2	20
FFB36A0625K--	6.2	19	9.4	17	32.7	25
FFB46A0755K--	7.5	26	11.4	14	29.9	32
FFB56A0106K--	10	R68 (2 terminals)	12	11	24.2	40
FFB56A0106KJC	10	R68 (4 terminals)	15.2	11	24.2	40
V_ndc 900V Vrms max.: 150 volts Voltage Code: C						
FFB16C0205K--	2	PO	3.6	41	45.7	15
FFB26C0275K--	2.7	18	4.9	30	36.6	20
FFB36C0395K--	3.9	19	7.2	21	32.9	25
FFB46C0515K--	5.1	26	9.3	16	29.7	32
FFB56C0685K--	6.8	R68 (2 terminals)	12	12	24.1	40
FFB56C0685KJC	6.8	R68 (4 terminals)	12.5	12	24.1	40
V_ndc 1100V Vrms max.: 180 volts Voltage Code: L						
FFB16L0155K--	1.5	PO	3.3	45	45.2	15
FFB26L0185K--	1.8	18	3.9	40	36.5	20
FFB36L0245K--	2.4	19	5.3	28	33.4	25
FFB46L0305K--	3	26	6.6	23	30.2	32
FFB56L0475K--	4.7	R68 (2 terminals)	10.3	15	24.1	40
FFB56L0475KJC	4.7	R68 (4 terminals)	10.3	15	24.1	40

Medium Power Film Capacitors

FFV3 (RoHS Compliant)



DC FILTERING

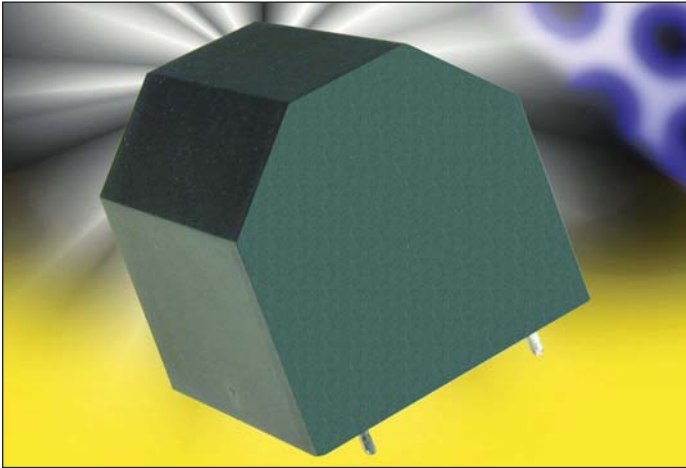

Check for up-to-date CV Tables at
<http://www.avx.com/docs/catalogs/filmcaps.pdf>

APPLICATIONS

The FFV3 capacitors are particularly designed for DC filtering, low reactive power.

STANDARDS

- IEC 61071-1, IEC 61071-2: Power electronic capacitors
- IEC 60384-16: Fixed metallized polypropylene film dielectric DC capacitors
- IEC 60384-16-1: Fixed metallized polypropylene film dielectric DC capacitors Assessment level E
- IEC 60384-17: Fixed metallized polypropylene film dielectric AC and pulse capacitors
- IEC 60384-17-1: Fixed metallized polypropylene film dielectric AC and pulse capacitors Assessment level E
- IEC 60384-2: Fixed metallized polyester capacitors

LIFETIME EXPECTANCY

One unique feature of this technology (as opposed to electrolytics) is how the capacitor reacts at the end of its lifetime. Unlike aluminum, electrolytics film capacitors do not have a catastrophic failure mode. Film capacitors simply experience a parametric loss of capacitance of about 2%, with no risk of short circuit.

Please note that this is theoretical, however, as the capacitor continues to be functional even after this 2% decrease.

PACKAGING MATERIAL

Self-extinguishing plastic case (V0 = in accordance with UL 94) filled thermosetting resin.

Self-extinguishing thermosetting resin (V0 = in accordance with UL 94; I3F2 = in accordance with NF F 16-101).

The series uses a non-impregnated metallized polypropylene or polyester dielectric, with the controlled self-healing process, specially treated to have a very high dielectric strength in operating conditions up to 105°C.

The FFV3 has been designed for printed circuit board mounting.

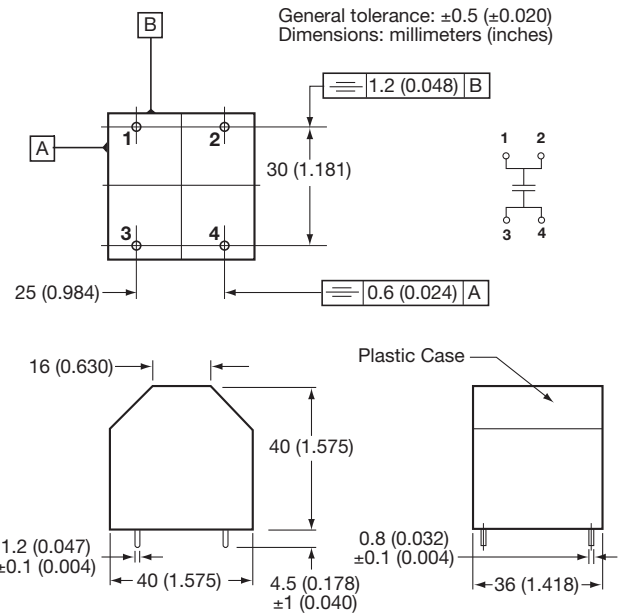

HOT SPOT CALCULATION

See *Hot Spot Temperature*, page 3.

$$\theta_{\text{hot spot}} = \theta_{\text{ambient}} + (P_d + P_t) \times (R_{\text{th}} + 7.4)$$

$$\theta_{\text{hot spot}} = \theta_{\text{case}} + (P_d + P_t) \times R_{\text{th}}$$

with P_d (Dielectric losses) = $Q \times \text{tg}\delta_0$
 $\Rightarrow [\frac{1}{2} \times C_n \times (V_{\text{peak to peak}})^2 \times f] \times \text{tg}\delta_0$
 $\text{tg}\delta_0$ (tan delta)

For polypropylene, $\text{tg}\delta_0 = 2 \times 10^{-4}$ for frequencies up to 1MHz and is independent of temperatures. For polyester, $\text{tg}\delta_0$ values are shown in graph 4 on page 3.

$$P_t \text{ (Thermal losses)} = R_s \times (I_{\text{rms}})^2$$

where C_n in Farad I_{rms} in Ampere f in Hertz
 V in Volt R_s in Ohm θ in °C
 R_{th} in °C/W R_{th} : R_{th} case/hot spot in °C/W

Medium Power Film Capacitors

FFV3 (RoHS Compliant) for Low Voltage Applications



HOW TO ORDER

FFV3 Series	4 Dielectric 4 = Polyester 6 = Polypropylene	D Voltage Code D = 75Vdc E = 100Vdc F = 160Vdc H = 300Vdc I = 400Vdc	K Capacitance Tolerances K = ±10%	-- Lead Styles -- = Standard Consult Factory for Special Options
		J = 500Vdc A = 700Vdc C = 900Vdc L = 1100Vdc		

ELECTRICAL CHARACTERISTICS – POLYESTER DIELECTRIC

Climatic category	40/105/56 (IEC 60068)
Test voltage between terminals @ 25°C	1.5 x V _{Ndc} during 10s
Test voltage between terminals and case @ 25°C “	@ 4 kVrms @ 50 Hz during 1 min.
Capacitance range C _n	30µF to 160µF
Tolerance on C _n	±10%
Rated DC voltage V _{Ndc}	75 to 400 V
Dielectric	polyester
Max Stray Inductance	15nH

RATINGS AND PART NUMBER REFERENCE – POLYESTER DIELECTRIC

Part Number	Capacitance (µF)	I _{rms max.} (A)	(I ² t) _{10 shots} (A ² s)	(I ² t) _{1000 shots} (A ² s)	R _s (mΩ)	R _{th} (°C/W)	Typical Weight (g)
V_{Ndc} = 75 V Vrms = 45 v max Voltage Code: D							
FFV34D0137K--	130	23	370	37	0.56	5.60	90
FFV34D0167K--	160	28	560	56	0.47	5.00	90
V_{Ndc} = 100 V Vrms = 60 v max Voltage Code: E							
FFV34E0806K--	80	19	250	25	0.67	6.16	90
FFV34E0107K--	100	24	390	39	0.55	5.42	90
V_{Ndc} = 160 V Vrms = 75 v max Voltage Code: F							
FFV34F0556K--	55	17	180	18	0.77	6.56	90
FFV34F0656K--	65	20	260	26	0.66	5.97	90
V_{Ndc} = 300 V Vrms = 90 v max Voltage Code: H							
FFV34H0406K--	40	20	150	15	2.80	9.58	90
FFV34H0506K--	50	26	230	23	2.25	8.46	90
V_{Ndc} = 400 V Vrms = 105 v max Voltage Code: I							
FFV34I0306K--	30	17	110	11	2.93	9.92	90
FFV34I0406K--	40	23	200	20	2.21	8.41	90

LIFETIME EXPECTANCY vs V_w/V_N AND HOT SPOT TEMPERATURE POLYESTER DIELECTRIC

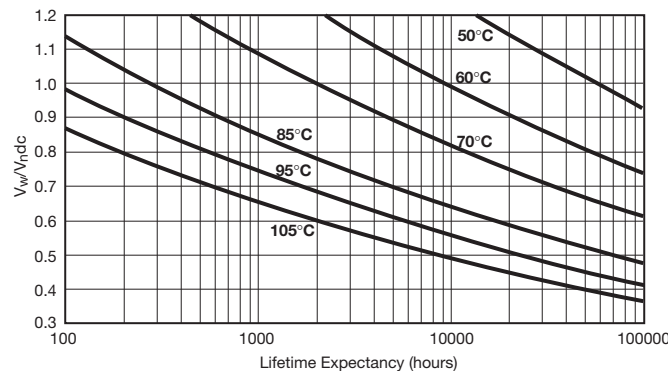

V_w = Permanent working or operating DC voltage.

Medium Power Film Capacitors

FFV3 (RoHS Compliant) DC for Medium and High Voltage Applications



DC FILTERING

ELECTRICAL CHARACTERISTICS – POLYPROPYLENE DIELECTRIC

Climatic category	40/105/56 (IEC 60068)
Test voltage between terminals @ 25°C	1.5 x V_{Ndc} during 10s
Test voltage between terminals and case @ 25°C “ @ 4 kVrms @ 50 Hz during 1 min.	
Capacitance range C_n	6 μ F to 25 μ F
Tolerance on C_n	$\pm 10\%$
Rated DC voltage V_{Ndc}	500 to 1100 V
Dielectric	polypropylene
Max Stray Inductance	15nH

RATINGS AND PART NUMBER REFERENCE – POLYESTER DIELECTRIC

Part Number	Capacitance (μ F)	$I_{rms\ max.}$ (A)	$(I^2t)_{10\ shots}$ (A ² s)	$(I^2t)_{1000\ shots}$ (A ² s)	R_s (m Ω)	R_{th} (°C/W)	Typical Weight (g)
$V_{Ndc} = 500\ V$ $V_{rms} = 105\ v\ max$ Voltage Code: J							
FFV36J0206K--	20	27	3200	320	5.88	3.53	90
FFV36J0256K--	25	33	5000	500	4.72	3.14	90
$V_{Ndc} = 700\ V$ $V_{rms} = 120\ v\ max$ Voltage Code: A							
FFV36A0146K--	14	21	2000	200	7.34	3.73	90
FFV36A0206K--	20	30	4200	420	5.15	3.05	90
$V_{Ndc} = 900\ V$ $V_{rms} = 150\ v\ max$ Voltage Code: C							
FFV36C0106K--	10	19	1600	160	8.21	3.37	90
FFV36C0136K--	13	25	2800	280	6.33	2.91	90
$V_{Ndc} = 1100\ V$ $V_{rms} = 180\ v\ max$ Voltage Code: L							
FFV36L0605K--	6	13	800	80	11.4	3.71	90
FFV36L0905K--	9	20	1900	190	7.61	2.92	90

LIFETIME EXPECTANCY vs V_w/V_{Ndc} AND HOT SPOT TEMPERATURE POLYPROPYLENE DIELECTRIC

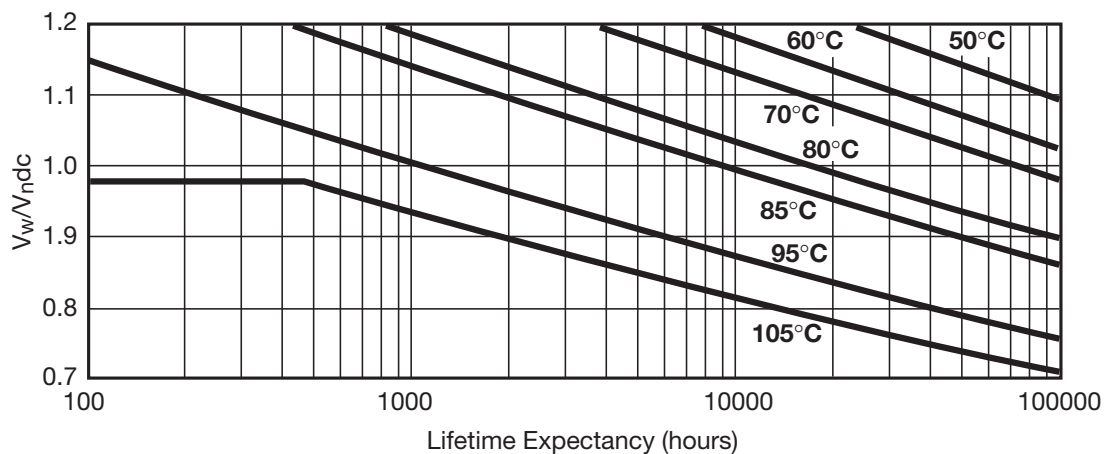

V_w = Permanent working or operating DC voltage.

Medium Power Film Capacitors

FFG Design (FFH-RoHS Compliant)



DC FILTERING



Check for up-to-date CV Tables at <http://www.avx.com/docs/catalogs/filmcaps.pdf>

DIMENSIONS (CASE SIZES)

plastic case – Outputs: threaded insert M8 filled with thermosetting resin

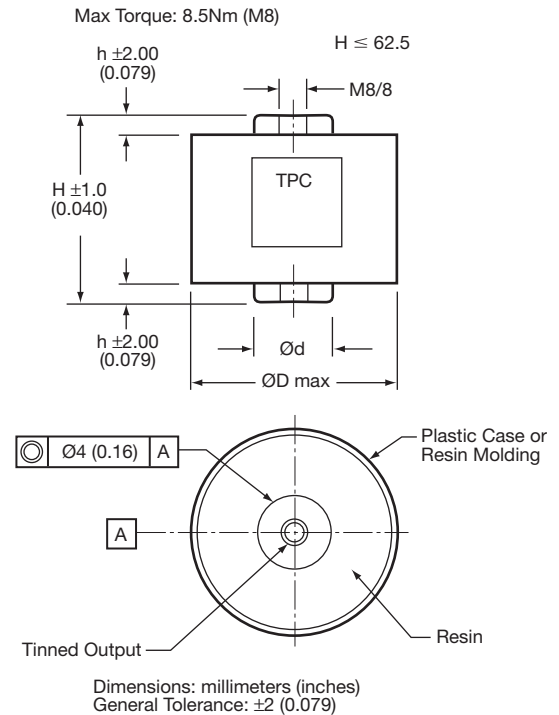

GENERAL DESCRIPTION

The FFG series uses a non-impregnated metallized dielectric, which features a controlled self-healing process.

PACKAGING MATERIAL

Self-extinguishing plastic case (V0 = in accordance with UL 94) filled thermosetting resin. Self-extinguishing thermosetting resin (V0 = in accordance with UL 94; I3F1 = in accordance with NF F 16-101).

STANDARDS

IEC 61071-1, IEC 61071-2: Power electronic capacitors
IEC 60068-1: Environmental testing
UL 94: Fire requirement

HOT SPOT CALCULATION

$$\theta_{\text{hot spot}} = \theta_{\text{terminal}} + (P_d + P_t) \times R_{\text{th}}$$

with P_d (Dielectric losses) = $Q \times \text{tg}\delta_0$ and $\text{tg}\delta_0 = 2.10$, where $Q = \frac{I_{\text{rms}}^2}{C \cdot 2 \cdot \pi \cdot f}$

$$P_t \text{ (Thermal losses)} = R_s \times I_{\text{rms}}^2$$

where C_n in Farad I_{rms} in Ampere f in Hertz
V in Volt R_s in Ohm θ in °C
 R_{th} in °C/W

HOW TO ORDER

FFG	8	6	K	0376	K	--
Series	Case Size	Dielectric	Voltage Code	Capacitance Code	Capacitance Tolerances	Voltage Range
FFG = Standard FFH = RoHS Compliant	8	6 = Polypropylene	K = 600Vdc B = 800Vdc C = 900Vdc L = 1000Vdc U = 1200Vdc N = 1900Vdc	0 + pF code 0376 = 36µF 0256 = 25µF 0505 = 5µF etc.	K = ±10%	-- = < 1kV J7 = ≥ 1kV

Medium Power Film Capacitors



FFG (FFH RoHS Compliant)

ELECTRICAL CHARACTERISTICS

Operating temperature:	-40°C + 105°C
Storage temperature:	-55°C + 85°C
Capacitance range:	5µF to 160µF
Rated DC voltage V _{ndc} :	600 to 900 V
Capacitance tolerance:	±10%
Test voltage between terminals:	@ 25°C: 1.5 x U _n dc during 10s
Test voltage between terminals and case:	@ 25°C: @ 4 kVrms @ 50 Hz during 1 mn (test type)
Dielectric	Polypropylene

RATINGS AND PART NUMBER REFERENCE (600V TO 900V)

Part Number	Cn (µF)	Height ±1 (±0.039)	h ±2 (±0.079)	D max)	d ±0.50	I ² t max (±0.020)	I _{rms} max (A ² s)	R _s (mΩ/A)	R _{th} (°C/W)	Typical Weight (g)
U_ndc 600 V (Voltage Code K)										
FFG86K0376K--	37	52 (2.072)	5 (0.197)	60 (2.362)	22 (0.866)	4	28	1.3	10.1	190
FFG86K0586K--	58	52 (2.072)	5 (0.197)	72 (2.835)	22 (0.866)	10	44	1	6.4	260
FFG86K0806K--	80	52 (2.072)	5 (0.197)	82 (3.228)	22 (0.866)	20	61	0.7	4.9	320
FFG86K0167K--	160	62.5 (2.461)	5 (0.197)	92 (3.622)	22 (0.866)	32	76	0.8	5.8	475
U_ndc 800 V (Voltage Code B)										
FFG86B0236K--	23	52 (2.072)	5 (0.197)	60 (2.362)	22 (0.866)	3	26	1.7	10.1	190
FFG86B0376K--	37	52 (2.072)	5 (0.197)	72 (2.835)	22 (0.866)	8	43	1.2	6.5	260
FFG86B0516K--	51	52 (2.072)	5 (0.197)	82 (3.228)	22 (0.866)	15	59	0.9	4.8	320
FFG86B0107K--	100	62.5 (2.461)	5 (0.197)	92 (3.622)	22 (0.866)	24	73	1	5.9	475
U_ndc 900 V (Voltage Code C)										
FFG86C0166K--	16	52 (2.072)	5 (0.197)	60 (2.362)	22 (0.866)	2.8	27	2	9.8	190
FFG86C0266K--	26	52 (2.072)	5 (0.197)	72 (2.835)	22 (0.866)	7	44	1.3	6.5	260
FFG86C0356K--	35	52 (2.072)	5 (0.197)	82 (3.228)	22 (0.866)	13	60	1	4.8	320
FFG86C0706K--	70	62.5 (2.461)	5 (0.197)	92 (3.622)	22 (0.866)	20	75	1.2	5.8	475

Dimensions millimeters (inches)

LIFETIME EXPECTANCY vs HOT SPOT TEMPERATURE AND VOLTAGE

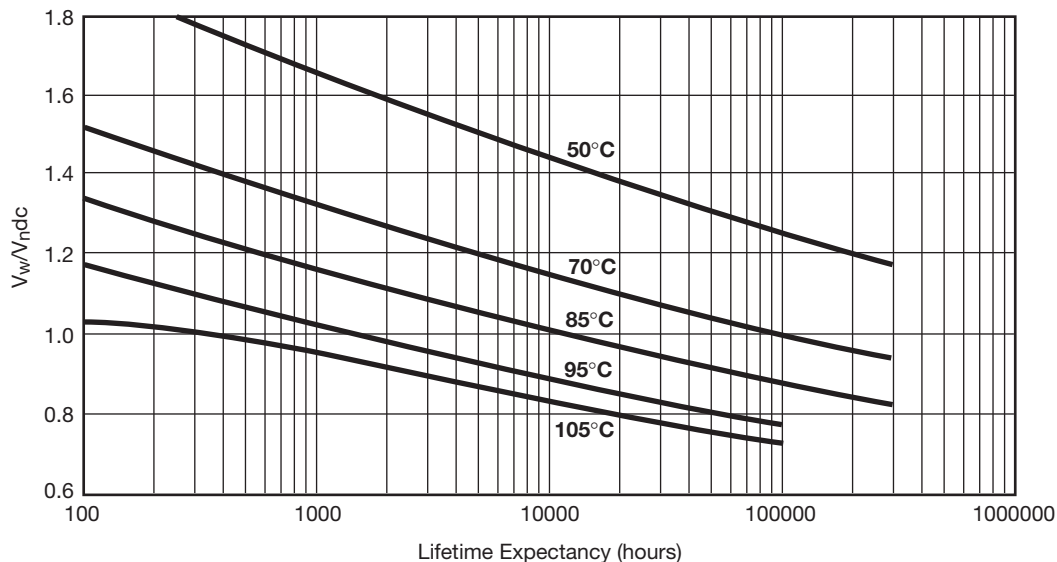

V_w = Permanent working or operating DC voltage.

Medium Power Film Capacitors

FFG (FFH RoHS Compliant)



ELECTRICAL CHARACTERISTICS

Operating temperature:	-40°C + 105°C
Storage temperature:	-55°C + 85°C
Capacitance range:	5µF to 160µF
Rated DC voltage V _{ndc} :	1000 to 1900 V
Capacitance tolerance:	±10%
Test voltage between terminals:	@ 25°C: 1.5 x U _n dc during 10s
Test voltage between terminals and case:	@ 25°C: @ 4 kVrms @ 50 Hz during 1 mn (test type)
Dielectric	Polypropylene

RATINGS AND PART NUMBER REFERENCE (600V TO 900V)

Part Number	C _n (µF)	Height ±1 (±0.039)	h ±2 (±0.079)	D max)	d ±0.50	l ² max (±0.020)	I _{rms} max (A ² s)	R _s (mΩ) (A)	R _{th} (°C/W)	Typical Weight (g)
U_ndc 1000 V (Voltage Code K)										
FFG86L0256KJ7	25	52 (2.072)	5 (0.197)	60 (2.362)	22 (0.866)	1.9	21	3.6	9.9	190
FFG86L0406KJ7	40	52 (2.072)	5 (0.197)	72 (2.835)	22 (0.866)	5	34	2.32	6.4	260
FFG86L0556KJ7	55	52 (2.072)	5 (0.197)	82 (3.228)	22 (0.866)	9.5	46	1.74	4.7	320
FFG86L0117KJ7	110	62.5 (2.461)	5 (0.197)	92 (3.622)	22 (0.866)	14.9	58	1.86	5.7	475
U_ndc 1200 V (Voltage Code U)										
FFG86U0176KJ7	17	52 (2.072)	5 (0.197)	60 (2.362)	22 (0.866)	1.3	19	4.33	9.9	190
FFG86U0276KJ7	27	52 (2.072)	5 (0.197)	72 (2.835)	22 (0.866)	3.3	30	2.8	6.5	260
FFG86U0376KJ7	37	52 (2.072)	5 (0.197)	82 (3.228)	22 (0.866)	6.2	41	2.1	4.8	320
FFG86U0766KJ7	76	62.5 (2.461)	5 (0.197)	92 (3.622)	22 (0.866)	10.3	53	2.2	5.6	475
U_ndc 1900 V (Voltage Code N)										
FFG86N0505KJ7	5	52 (2.072)	5 (0.197)	60 (2.362)	22 (0.866)	1.7	19	2.77	11.3	190
FFG86N0905KJ7	9	52 (2.072)	5 (0.197)	72 (2.835)	22 (0.866)	5.5	35	1.63	6.6	260
FFG86N0126KJ7	12	52 (2.072)	5 (0.197)	82 (3.228)	22 (0.866)	9.9	46	1.27	5	320
FFG86N0256KJ7	25	62.5 (2.461)	5 (0.197)	92 (3.622)	22 (0.866)	18	63	1.2	5.2	475

Dimensions millimeters (inches)

LIFETIME EXPECTANCY vs HOT SPOT TEMPERATURE AND VOLTAGE

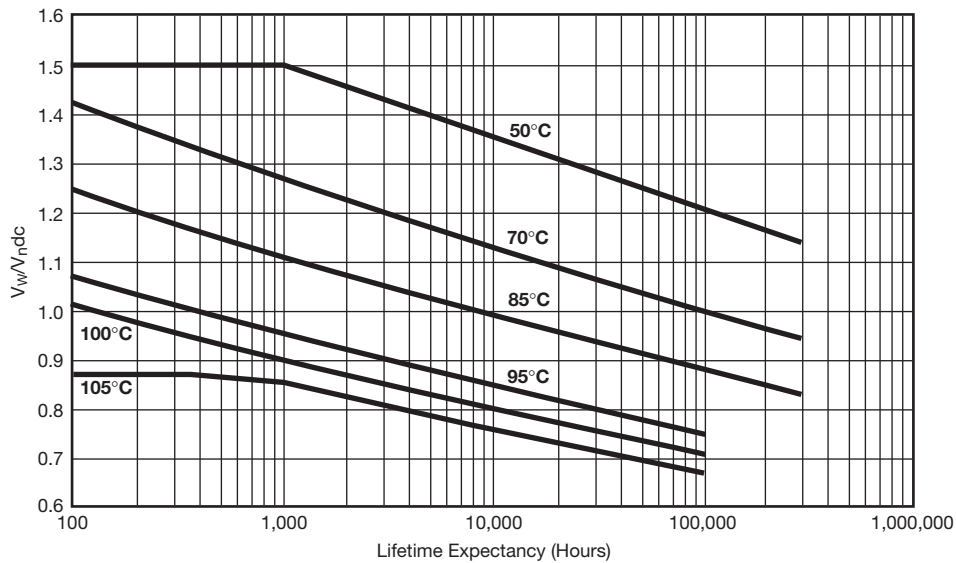

V_w = Permanent working or operating DC voltage.

Medium Power Film Capacitors

FFVE/FFVI (FFWE/FFWI RoHS Compliant)



GENERAL DESCRIPTION

The FFV capacitor is specifically designed for DC filtering, low reactive power.

The series uses a non-impregnated metallized polypropylene or polyester dielectric, which features a controlled self-healing process, specially treated to have a very high dielectric strength in operating conditions up to 105°C.

The FFV special design gives this series a very low level of stray inductance (18 nH to 40 nH).

Furthermore, the performance levels of the FFVE capacitor makes them a very interesting alternative to electrolytic technology, because they can withstand much higher levels of surge voltage, very high rms current ratings, and longer lifetimes.

PACKAGING MATERIAL

Self-extinguishing plastic case (V0 = in accordance with UL 94) filled thermosetting resin.

Self-extinguishing thermosetting resin (V0 = in accordance with UL 94; I3F1 = in accordance with NF F 16-101).

FFVE capacitors meet the Level 2 requirement of the fire behavior standard NF F 16-102.

Check for up-to-date CV Tables at <http://www.avx.com/docs/catalogs/filmcaps.pdf>

DIMENSIONS

Also available with threaded female connections - M5 x 7.5mm max Torque 2.5Nm

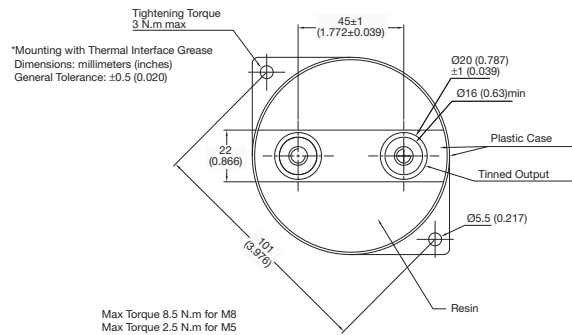
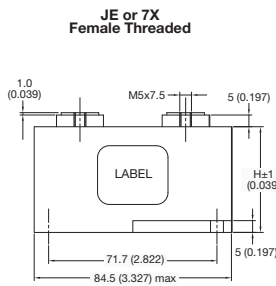
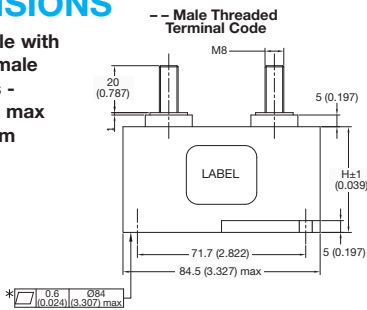

HOW TO ORDER

FFVE

Series
 FFVE = Standard
 FFVI = Standard
 FFWE = RoHS Compliant
 FFWI = RoHS Compliant

4

Dielectric
 4 = Polyester
 6 = Polypropylene

H

Voltage Code
 C = 900V
 L = 1000V (FFVE/FFWE)
 U = 1200V
 A = 700V
 B = 800V

0187

Capacitance Code
 0 + pF code
 0187 = 180µF
 0356 = 35µF
 etc.

K

Capacitance Tolerances
 K = ±10%

--

Terminal Code
 JE = Female Threaded
 -- = Male Threaded
 • FFVE/FFWE – Polyester
 • FFVE/FFWE – Polypropylene < 1kv
 • FFVI/FFWI
 7X = Female Threaded
 J7 = Male Threaded
 • FFVE/FFWE – Polypropylene ≥ 1kv

HOT SPOT CALCULATION

See Hot Spot Temperature, page 3.

$\theta_{hot\ spot} = \theta_{ambient} + (P_d + P_t) \times R_{th}$
 with P_d (Dielectric losses) = $Q \times tg\delta_0$
 $Q \times tg\delta_0 \Rightarrow [\frac{1}{2} \times C_n \times (V_{peak\ to\ peak})^2 \times f] \times tg\delta_0$
 $tg\delta_0$ (tan delta)
 For polypropylene, $tg\delta_0 = 2 \times 10^{-4}$ for frequencies up to 1MHz and is independent of temperatures. For polyester, $tg\delta_0$ values are shown in graph 4 on page 3.

P_t (Thermal losses) = $R_s \times (I_{rms})^2$

where C_n in Farad I_{rms} in Ampere f in Hertz
 V in Volt R_s in Ohm θ in °C
 R_{th} in °C/W

θ_{case} = bottom center of case

Rs(f) vs FREQUENCY

For frequency higher than 1 kHz use following curve

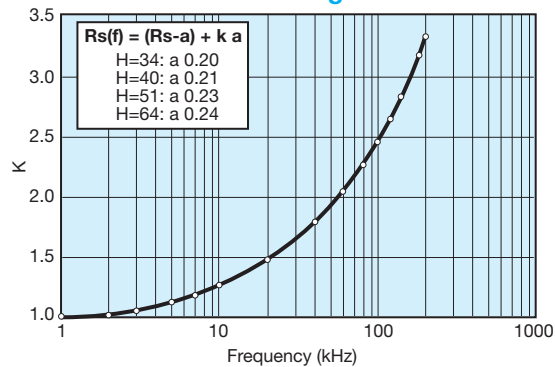

Medium Power Film Capacitors

FFVE/FFVI (FFWE/FFWI RoHS Compliant)



ELECTRICAL CHARACTERISTICS – FFVE/FFWE POLYESTER DIELECTRIC

The FFVE for low voltage DC filtering are polyester dielectric capacitors.

Working temperature	-40°C to +105°C (according to the power to be dissipated)
Capacitance range	100µF to 400µF
Capacitance tolerance	±10%
Rated DC voltage	300 to 400 V
Test voltage between terminals @ 25°C	1.5 x V _n dc 10s
Insulation voltage between shorted terminals and earth	7 kVrms/60sec/50Hz
Dielectric	Polyester

RATINGS AND PART NUMBER REFERENCE – POLYESTER DIELECTRIC

Part Number*	Capacitance (µF)	Height	Irms max. (A)	Ls max. (nH)	Rs (mΩ)	Rth (°C/W)	Typical Weight (g)
V_ndc 300 volts (Voltage Code H)							
FFVE4H0187K--	180	34 (1.339)	100	18	0.8	4.7	300
FFVE4H1956K--	195	34 (1.339)	100	18	0.8	4.4	300
FFVE4H0257K--	250	40 (1.575)	100	25	0.6	5.2	350
FFVE4H0357K--	350	51 (2.008)	100	32	0.8	7.2	420
FFVE4H0407K--	400	51 (2.008)	110	32	0.8	7.1	420
V_ndc 400 volts (Voltage Code I)							
FFVE4I0107K--	100	34 (1.339)	80	18	0.7	4.7	300
FFVE4I0127K--	120	34 (1.339)	100	18	0.6	4.1	300
FFVE4I0157K--	150	40 (1.575)	100	25	0.7	5.0	350
FFVE4I0187K--	180	51 (2.008)	80	32	1.0	8.5	420
FFVE4I0227K--	220	51 (2.008)	100	32	0.9	7.2	420

*Change "--" to "JE" for female connectors M5 x 7.5mm

Dimensions millimeters (inches)

LIFETIME EXPECTANCY FFVE POLYESTER

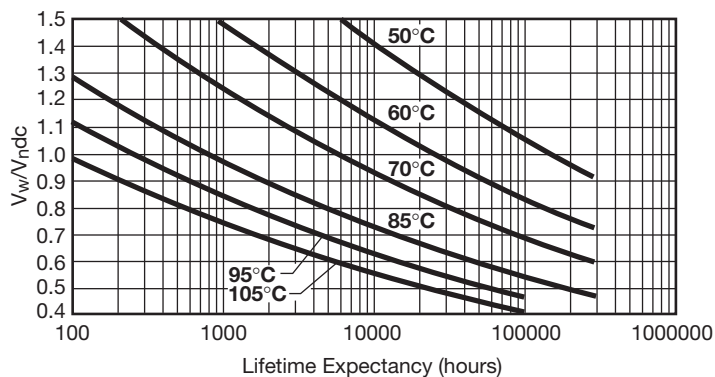

V_w : permanent working or operating DC voltage.

Medium Power Film Capacitors

FFVE/FFVI (FFWE/FFWI RoHS Compliant)



ELECTRICAL CHARACTERISTICS – FFVE/FFWE POLYPROPYLENE DIELECTRIC

The FFVE for low voltage DC filtering are polyester dielectric capacitors.

Working temperature	-40°C to +105°C (according to the power to be dissipated)
Capacitance range	12µF to 220µF
Capacitance tolerance	±10%
Rated DC voltage	600 to 1900 V
Test voltage between terminals @ 25°C	1.5 x V _n dc 10s
Insulation voltage between shorted terminals and earth	7 kVrms/60sec/50Hz
Dielectric	Polypropylene

RATINGS AND PART NUMBER REFERENCE – POLYESTER DIELECTRIC

Part Number*	Capacitance (µF)	Height	Irms max. (A)	Ls max. (nH)	Rs (mΩ)	Rth (°C/W)	Typical Weight (g)
V_ndc 600 volts (Voltage Code K)							
FFVE6K0256K--	25	34 (1.339)	90	18	0.7	4.3	300
FFVE6K0107K--	100	40 (1.575)	100	25	0.6	4.8	350
FFVE6K0157K--	150	51 (2.008)	110	32	0.9	6.9	420
FFVE6K0227K--	220	64 (2.520)	100	40	1.0	8.4	500
V_ndc 800 volts (Voltage Code B)							
FFVE6B0666K--	66	40 (1.575)	100	25	0.7	4.7	350
FFVE6B0107K--	100	51 (2.008)	90	32	1.0	6.7	420
FFVE6B0147K--	140	64 (2.520)	100	40	1.3	8.4	500
V_ndc 900 volts (Voltage Code C)							
FFVE6C0126K--	12	34 (1.339)	70	18	0.9	4.4	300
FFVE6C0386K--	38	34 (1.339)	100	18	1.6	3.9	300
FFVE6C0476K--	47	40 (1.575)	100	25	0.8	4.6	350
FFVE6C0706K--	70	51 (2.008)	100	32	1.2	6.7	420
FFVE6C0107K--	100	64 (2.520)	90	40	1.1	8.2	500
V_ndc 1000 volts (Voltage Code L)							
FFVE6L0666KJ7	66	40 (1.575)	70	25	1.5	5.1	350
FFVE6L0107KJ7	100	51 (2.008)	64	32	2.0	7.3	420
FFVE6L0147KJ7	140	64 (2.520)	51	40	2.5	9.2	500
V_ndc 1200 volts (Voltage Code U)							
FFVE6U0476KJ7	47	40 (1.575)	66	25	1.7	4.9	350
FFVE6U0706KJ7	70	51 (2.008)	59	32	2.4	7.2	420
FFVE6U0107KJ7	100	64 (2.520)	49	40	2.9	8.9	500
V_ndc 1900 volts (Voltage Code N)							
FFVE6N0156KJ7	15	40 (1.575)	73	25	1.1	5.2	350
FFVE6N0246KJ7	24	51 (2.008)	73	32	1.3	6.5	420
FFVE6N0356KJ7	35	64 (2.520)	67	40	1.6	8.4	500

*Change "--" to "JE" for female connectors M5 x 7.5mm
 *Change "J7" to "7X" for female connectors M5 x 7.5mm

Dimensions millimeters (inches)

LIFETIME EXPECTANCY FOR FFVE POLYPROPYLENE

-- and JE

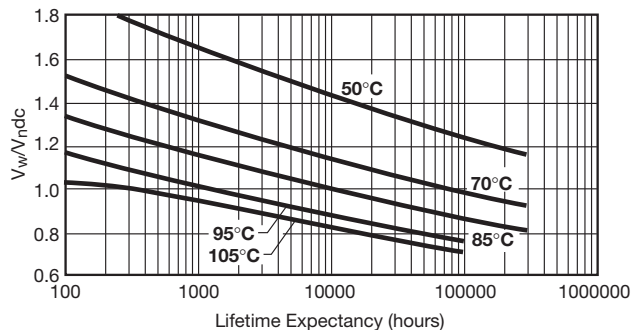

V_w: permanent working or operating DC-voltage.

J7 and 7X

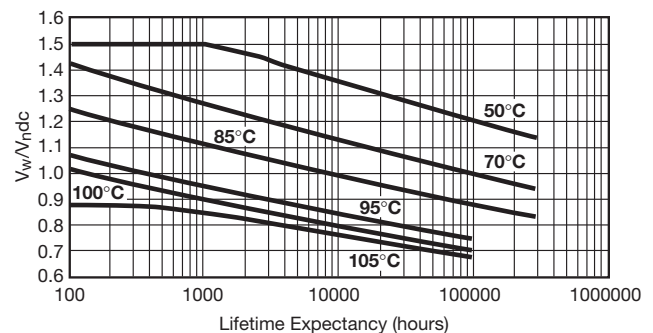

V_w: permanent working or operating DC-voltage.

Medium Power Film Capacitors

FFVE/FFVI (FFWE/FFWI RoHS Compliant)



ELECTRICAL CHARACTERISTICS – FFVI/FFWI POLYPROPYLENE DIELECTRIC

The FFVE for low voltage DC filtering are polyester dielectric capacitors.

Working temperature	-40°C to +105°C (according to the power to be dissipated)
Capacitance range	47µF to 275µF
Capacitance tolerance	±10%
Rated DC voltage	500 to 1100V
Test voltage between terminals @ 25°C	1.25 x V_{Ndc} 10s
Insulation voltage between shorted terminals and earth	7 kVrms/60sec/50Hz
Dielectric	Polypropylene

RATINGS AND PART NUMBER REFERENCE – POLYESTER DIELECTRIC

Part Number*	Capacitance (µF)	Height	Irms max. (A)	Ls max. (nH)	Rs (mΩ)	Rth (°C/W)	Typical Weight (g)
V_{Ndc} 500 volts (Voltage Code J)							
FFVI6J1256K--	125	40 (1.575)	90	25	0.6	5.0	350
FFVI6J0207K--	200	51 (2.008)	90	32	0.8	6.7	420
FFVI6J2756K--	275	64 (2.520)	90	40	0.9	8.7	500
V_{Ndc} 700 volts (Voltage Code A)							
FFVI6A0107K--	100	40 (1.575)	100	25	0.6	4.8	350
FFVI6A0157K--	150	51 (2.008)	100	32	0.9	6.9	420
FFVI6A0227K--	220	64 (2.520)	100	40	1.0	8.4	500
V_{Ndc} 900 volts (Voltage Code C)							
FFVI6C0666K--	66	40 (1.575)	100	25	0.7	4.7	350
FFVI6C0107K--	100	51 (2.008)	90	32	1.0	6.7	420
FFVI6C0147K--	140	64 (2.520)	100	40	1.3	8.4	500
V_{Ndc} 1100 volts (Voltage Code L)							
FFVI6L0476K--	47	40 (1.575)	100	25	0.8	4.6	350
FFVI6L0706K--	70	51 (2.008)	100	32	1.2	6.7	420
FFVI6L0107K--	100	64 (2.520)	90	40	1.1	8.2	500

Dimensions millimeters (inches)

LIFETIME EXPECTANCY FOR FFVI

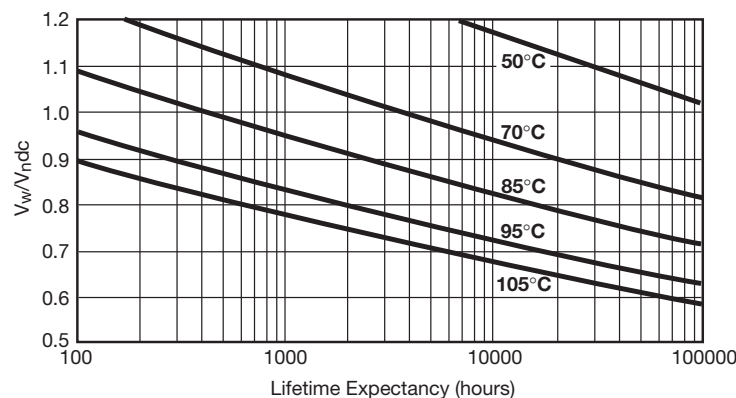

V_w : permanent working or operating DC-voltage.

Medium Power Film Capacitors

FFVS (RoHS Compliant)

Low Inductance Range Capacitor for Power Electronics



FFVS series is a specific range of DC filtering capacitors designed for use in high frequency, high ripple applications beyond the limits of standard FFVE or FFVI.

Typical applications include DC power supply for induction heating, resonant DC power supply for scanner, X-ray machines, etc.

Due to the sophisticated internal design, stray inductance is extremely low, between 8 and 13nH.

FFVS products are RoHs compliant.

Check for up-to-date CV Tables at <http://www.avx.com/docs/catalogs/filmcaps.pdf>

PACKAGING MATERIAL

Self extinguishing plastic case (V0: in accordance with UL 94) filled thermosetting resin.

Self extinguishing thermosetting resin (V0: in accordance with UL 94; I3F1: in accordance with NF F 16-101).

DIMENSIONS

Threaded female terminals version M5 x 7.5mm are also available, To order, the suffix becomes "JE" instead of "--"

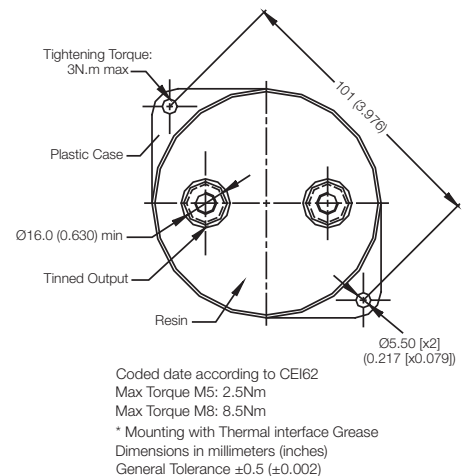
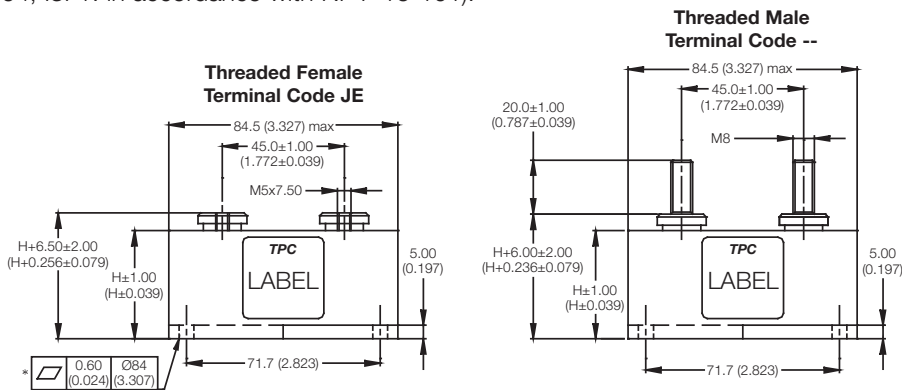

HOW TO ORDER

FFVS

Series

6

Dielectric
6 = Polypropylene

K

Voltage Code
K = 600V
B = 800V
C = 900V
L = 1000V
U = 1200V
N = 1900V

0226

Capacitance Code
Capacitance Values with 2 significant digits:
0 + pF code
0226 = 22µF
0147 = 140µF
etc.

Capacitance Values with 3 significant digits:
1956 = 195µF
1286 = 138µF
1356 = 135µF

K

Capacitance Tolerances
K = ±10%

--

Terminal Code
-- = Male Threaded
JE = Female Threaded

HOT SPOT CALCULATION

See Hot Spot Temperature, page 3.

$\theta_{hot\ spot} = \theta_{ambient} + (P_d + P_t) \times R_{th}$
with P_d (Dielectric losses) = $Q \times tg\delta_0$
 $Q \times tg\delta_0 \Rightarrow [\frac{1}{2} \times C_n \times (V_{peak\ to\ peak})^2 \times f] \times tg\delta_0$
 $tg\delta_0$ (tan delta)
For polypropylene, $tg\delta_0 = 2 \times 10^{-4}$ for frequencies up to 1MHz and is independent of temperatures.
For polyester, $tg\delta_0$ values are shown in graph 4 on page 3.

$$P_t \text{ (Thermal losses)} = R_s \times (I_{rms})^2$$

where C_n in Farad I_{rms} in Ampere f in Hertz
 V in Volt R_s in Ohm θ in °C
 R_{th} in °C/W

θ_{case} = bottom center of case

Medium Power Film Capacitors

FFVS (RoHS Compliant)

Low Inductance Range Capacitor for Power Electronics



ELECTRICAL CHARACTERISTICS

Working temperature	-40°C +105°C (according to the power to be dissipated)
Capacitance range C_N	22 μ F to 200 μ F
Tolerance on C_N	$\pm 10\%$
Rated dc voltage U_N dc	600V to 1900V
Test voltage between terminals @ 25°C: 1.5 x U_N dc during 10s	
Insulation voltage between shorted terminals and earth (type test) @ 4 kVrms @ 50Hz during 1 min.	

RATINGS AND PART NUMBER REFERENCE

Part Number	Capacitance (μ F)	Height mm (inches)	I_{rms} (A)	I^2t (A ² s)	L_s max.	R_S (m Ω) (nH)	R_{th} (°C/W)	Typical Weight (g)
U_Ndc 600 volts (Voltage Code K)								
FFVS6K0226K--	22	34 (1.339)	78	11.5	8	0.74	4.2	320
FFVS6K0906K--	90	40 (1.575)	84	24	9	0.60	4.9	345
FFVS6K0147K--	140	51 (2.008)	82	23.5	11	0.83	6.8	405
FFVS6K1956K--	195	64 (2.520)	84	24	13	1.04	8.6	475
U_Ndc 800 volts (Voltage Code B)								
FFVS6B0586K--	58	40 (1.575)	83	19	9	0.72	4.9	345
FFVS6B0926K--	92	51 (2.008)	83	19	11	0.99	6.7	405
FFVS6B1286K--	128	64 (2.520)	84	19.5	13	1.25	8.5	475
U_Ndc 900 volts (Voltage Code C)								
FFVS6C0306K--	30	34 (1.339)	56	7	8	1.55	4.2	320
FFVS6C0406K--	40	40 (1.575)	85	16.5	9	0.85	5.0	345
FFVS6C0656K--	65	51 (2.008)	86	17	11	1.15	6.7	405
FFVS6C0906K--	90	64 (2.520)	87	17	13	1.46	8.5	475
U_Ndc 1000 volts (Voltage Code L)								
FFVS6L0536K--	53	40 (1.575)	61	9.5	9	1.56	4.9	345
FFVS6L0956K--	95	51 (2.008)	63	11	11	1.98	6.7	405
FFVS6L1356K--	135	64 (2.520)	65	11.5	13	2.42	8.3	475
U_Ndc 1200 volts (Voltage Code U)								
FFVS6U0406K--	40	40 (1.575)	57	7.5	9	1.77	4.9	345
FFVS6U0656K--	65	51 (2.008)	57	7.5	11	2.38	6.8	405
FFVS6U0866K--	86	64 (2.520)	58	7	13	3.02	8.5	475
U_Ndc 1900 volts (Voltage Code N)								
FFVS6N0146K--	14	40 (1.575)	66	12.5	10	1.05	4.9	345
FFVS6N0226K--	22	51 (2.008)	68	13.5	13	1.26	6.3	405
FFVS6N0326K--	32	64 (2.520)	68	13.5	16	1.58	8.1	475

Dimensions millimeters (inches)

LIFETIME EXPECTANCY

FFVS for 600V, 800V and 900V

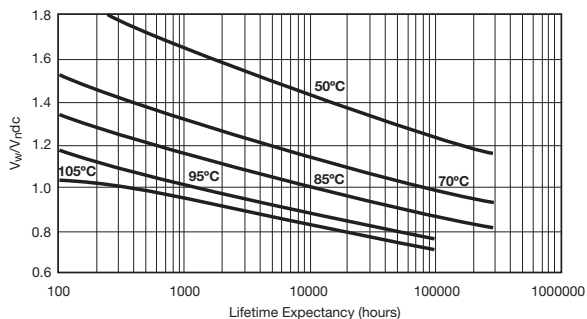

V_w : permanent working or operating DC-voltage.

FFVS for 1000V, 1200V and 1900V

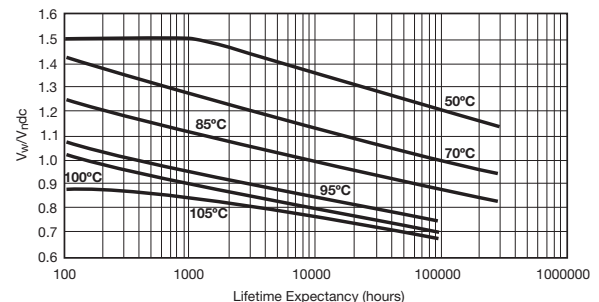

V_w : permanent working or operating DC-voltage.



USUAL APPLICATIONS

The FFLI capacitor is specifically designed for DC filtering,

PACKAGING MATERIAL

Aluminium cylindrical case filled thermosetting resin.

Self extinguishing thermosetting resin (V0 : in accordance with UL 94 ; M2F1 : in accordance with NF F 16-101).

Self extinguishing plastic cover (V0 : in accordance with UL 94)

ROHS components

LIFETIME EXPECTANCY

One unique feature of this technology (as opposed to electrolytics) is how the capacitor reacts at the end of its lifetime. With an electrolytic there is a strong risk of explosion of the case. However with our line of film capacitors, the capacitor will simply experience at the end of life a loss of capacitance of about 5%, with no risk of explosion.

Please note that this is theoretical, however, the capacitor continues to be functional even after this 5% decrease.

Expected life time for FFLI range:

100 000 Hrs / $U_{n,dc}$ / Hot-spot temperature = 65°C.



Check for up-to-date CV Tables at

<http://www.avx.com/docs/catalogs/filmcaps.pdf>

DIMENSIONS

Terminal Code JE
Threaded Female

Terminal Code --
Threaded Male

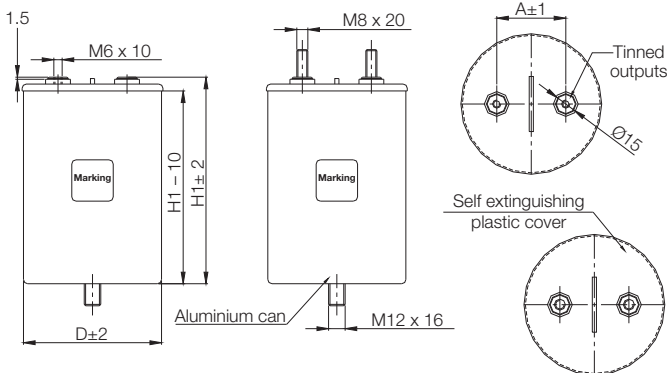

MARKING

Capacitance value	Max Torque M6 = 4.5.Nm
Nominal dc voltage	Max Torque M8 = 8.5Nm
Maximum rms current	Max Torque M12 = 15Nm
Batch number	
Coded date according IEC62	

STANDARDS

IEC 61071: Power electronic capacitors

IEC 60068-1: Environmental testing

IEC 61373: Shocks and vibrations

UL 94: Fire requirements

UL810: Capacitors

HOT SPOT CALCULATION

See *Hot Spot Temperature*, page 3.

For all applications, the hot spot temperature must be lower than 95°C.

$$\theta_{\text{hot spot}} = \theta_{\text{ambient}} + [\text{tg} \delta \cdot Q + R_s \cdot (I_{\text{rms}})^2] \cdot R_{\text{th}}$$

With:

Q : Reactive power in Var

R_s in Ohm

I_{rms} in Ampere

R_{th} : Rth ambient / hot spot in °C/W

$\text{tg} \delta_0 \cdot (10^{-4})$ is the tangent of loss angle for polypropylene dielectric. Polypropylene has a constant dielectric losses factor of 2×10^{-4} irrespective of temperature and frequency (up to 1 MHz).

θ_{Ambient} : Ambient Temperature in °C

HOW TO ORDER

FFLI

Series

6

Dielectric
6 = Polypropylene

L

Voltage Code
L = 1000V
U = 1200V
Q = 1400V

0337

Capacitance Code
Capacitance Values with 2 significant digits:
0 + pF code
0397 = 390µF
0167 = 160µF
etc.

K

Capacitance Tolerances
K = ±10%

--

Terminal Code
-- = Male Threaded
JE = Female Threaded

ELECTRICAL CHARACTERISTICS

Dry with controlled self-healing metallized polypropylene dielectric.

Climatic Category	40/95/56 (IEC68)
Working temperature	-40°C / + 95°C (according to the power dissipated)
Storage temperature	-40°C / +85°C
Test voltage between terminals	@ 25°C: 1.5 x U _n dc during 10s
Test voltage between terminals and case	@ 25°C:@ 4 kVrms @ 50Hz during 1 min.
Dielectric	Polypropylene

RATINGS AND PART NUMBER REFERENCE

Part Number	Capacitance (µF)	D	H1	A	I _{rms} (A)	I ² t (A ² s)	L _S max. (nH)	R _S (mΩ)	R _{th} (°C/W)	Typical Weight (g)
U_ndc 800V										
FFLI6B0297K--	290	75 (2.953)	105 (4.134)	32 (1.260)	50	13	60	4.1	4.1	500
FFLI6B0397K--	390	85 (3.346)	105 (4.134)	32 (1.260)	62	23	60	2.9	3.6	600
FFLI6B0507K--	500	75 (2.953)	155 (6.102)	32 (1.260)	45	13	85	5.6	3.6	600
FFLI6B0687K--	680	85 (3.346)	155 (6.102)	32 (1.260)	53	24	85	4.3	3.3	900
FFLI6B0817K--	810	85 (3.346)	180 (7.087)	32 (1.260)	50	23	100	5.1	3.1	1100
FFLI6B1007K--	1000	100 (3.937)	155 (6.102)	50 (13.78)	65	52	85	3.2	3.0	1200
FFLI6B1207K--	1200	100 (3.937)	180 (7.087)	50 (13.78)	61	52	100	3.7	2.9	1500
FFLI6B1357K--	1350	116 (4.567)	155 (6.102)	50 (13.78)	77	95	85	2.5	2.6	1700
FFLI6B1607K--	1600	116 (4.567)	180 (7.087)	50 (13.78)	72	93	100	3.0	2.6	2000
FFLI6B1907K--	1900	116 (4.567)	240 (9.449)	50 (13.78)	110	300	140	1.4	2.4	2600
FFLI6B2407K--	2400	116 (4.567)	290 (11.42)	50 (13.78)	100	300	170	1.6	2.2	3200
FFLI6B3007K--	3000	116 (4.567)	340 (13.39)	50 (13.78)	100	320	200	1.9	2.0	3800
U_ndc 1000V										
FFLI6L0197K--	190	75 (2.953)	105 (4.134)	32 (1.260)	46	8	60	4.5	4.1	200
FFLI6L0267K--	260	85 (3.346)	105 (4.134)	32 (1.260)	56	15	60	3.4	3.6	300
FFLI6L0337K--	330	75 (2.953)	155 (6.102)	32 (1.260)	40	8	85	6.8	3.6	600
FFLI6L0457K--	450	85 (3.346)	155 (6.102)	32 (1.260)	48	16	85	5.2	3.3	900
FFLI6L0547K--	540	85 (3.346)	180 (7.087)	32 (1.260)	45	16	100	6.1	3.1	1100
FFLI6L0657K--	650	100 (3.937)	155 (6.102)	50 (13.78)	60	33	85	3.8	3.0	1200
FFLI6L0787K--	780	100 (3.937)	180 (7.087)	50 (13.78)	55	33	100	4.5	2.9	1500
FFLI6L0907K--	900	116 (4.567)	155 (6.102)	50 (13.78)	72	64	85	2.9	2.6	1700
FFLI6L1107K--	1100	116 (4.567)	180 (7.087)	50 (13.78)	68	66	100	3.4	2.6	2000
FFLI6L1307K--	1300	116 (4.567)	240 (9.449)	50 (13.78)	100	210	140	1.5	2.4	2600
FFLI6L1807K--	1800	116 (4.567)	290 (11.42)	50 (13.78)	95	200	170	1.9	2.2	3200
FFLI6L2207K--	2200	116 (4.567)	340 (13.39)	50 (13.78)	95	200	200	2.2	2.0	3800
U_ndc 1150V										
FFLI6U0157K--	150	75 (2.953)	105 (4.134)	32 (1.260)	44	6	60	5.0	4.1	500
FFLI6U0207K--	200	85 (3.346)	105 (4.134)	32 (1.260)	53	11	60	3.9	3.6	600
FFLI6U0267K--	260	75 (2.953)	155 (6.102)	32 (1.260)	39	7	85	7.4	3.6	600
FFLI6U0357K--	350	85 (3.346)	155 (6.102)	32 (1.260)	45	12	85	5.9	3.3	900
FFLI6U0437K--	430	85 (3.346)	180 (7.087)	32 (1.260)	43	12	100	6.8	3.1	1100
FFLI6U0537K--	530	100 (3.937)	155 (6.102)	50 (13.78)	57	27	85	4.1	3.0	1200
FFLI6U0637K--	630	100 (3.937)	180 (7.087)	50 (13.78)	53	27	100	4.9	2.9	1500
FFLI6U0727K--	720	116 (4.567)	155 (6.102)	50 (13.78)	69	51	85	3.2	2.6	1700
FFLI6U0867K--	860	116 (4.567)	180 (7.087)	50 (13.78)	64	50	100	3.8	2.6	2000
FFLI6U1007K--	1000	116 (4.567)	240 (9.449)	50 (13.78)	95	160	140	1.7	2.4	2600
FFLI6U1307K--	1300	116 (4.567)	290 (11.42)	50 (13.78)	90	160	170	2.0	2.2	3200
FFLI6U1607K--	1600	116 (4.567)	340 (13.39)	50 (13.78)	90	160	200	2.3	2.0	3800
U_ndc 1400V										
FFLI6Q1056K--	105	75 (2.953)	105 (4.134)	32 (1.260)	41	5	60	5.8	4.1	500
FFLI6Q0147K--	140	85 (3.346)	105 (4.134)	32 (1.260)	50	8	60	4.5	3.6	600
FFLI6Q1856K--	185	75 (2.953)	155 (6.102)	32 (1.260)	35	5	85	8.8	3.6	600
FFLI6Q0257K--	250	85 (3.346)	155 (6.102)	32 (1.260)	42	9	85	6.7	3.3	900
FFLI6Q0307K--	300	85 (3.346)	180 (7.087)	32 (1.260)	40	9	100	7.9	3.1	1100
FFLI6Q0367K--	360	100 (3.937)	155 (6.102)	50 (13.78)	52	18	85	4.8	3.0	1200
FFLI6Q0447K--	440	100 (3.937)	180 (7.087)	50 (13.78)	50	19	100	5.6	2.9	1500
FFLI6Q0507K--	500	116 (4.567)	155 (6.102)	50 (13.78)	65	36	85	3.7	2.6	1700
FFLI6Q0607K--	600	116 (4.567)	180 (7.087)	50 (13.78)	60	35	100	4.3	2.6	2000
FFLI6Q0707K--	700	116 (4.567)	240 (9.449)	50 (13.78)	90	120	140	1.9	2.4	2600
FFLI6Q0907K--	900	116 (4.567)	290 (11.42)	50 (13.78)	90	120	170	2.3	2.2	3200
FFLI6Q1107K--	1100	116 (4.567)	340 (13.39)	50 (13.78)	85	120	200	2.7	2.0	3800

*Change "--" to "JE" for female terminals

Dimensions millimeters (inches)

Medium Power Film Capacitors

FFLC (RoHS Compliant)



DC FILTERING



APPLICATIONS

FFLC series is specifically designed for DC filtering, low reactive power.

PACKAGING MATERIAL

Non-painted rectangular resin filled aluminum case

FFLC capacitors meet the level 2 requirement of flammability standard NF F 16 102.

4 x M10 terminals*

NEW Available with M10 X 12 female terminal upon request

STANDARDS

IEC 61071-1: Power electronic capacitors

IEC 61071-2: Power electronic capacitors

IEC 60068-1: Environmental testing

IEC 60077: Rules for electric traction equipment

UL 94: Fire requirements

NF F 16-101

NF F 16-102: Fire and smoke requirements

IEC 61881: Railway applications, rolling stock equipment, capacitors for power electronics



Check for up-to-date CV Tables at
<http://www.avx.com/docs/catalogs/filmcaps.pdf>

DIMENSIONS

Terminal Code -- for male threaded
 Terminal Code JE for female threaded

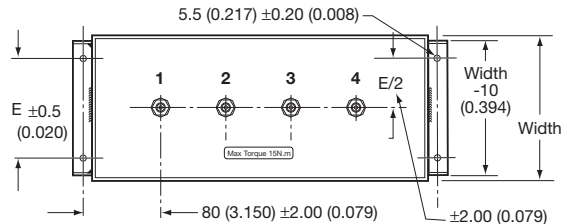
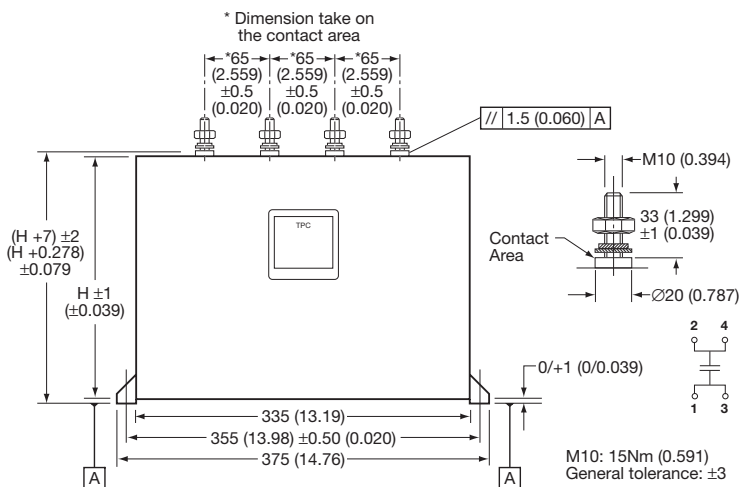

Width	E
170	100
145	100
95	50

HOW TO ORDER

FFLC

Series

6

Dielectric
 6 = Polypropylene

A

Voltage Code
 A = 680Vdc
 L = 1000Vdc
 U = 1200Vdc

8807

Capacitance Code
 4 digit pF code 1st
 3 digits are capacitance,
 last digit is multiplier, e.g.
 8807 = 8800µF
 5067 = 5060µF
 2247 = 2240µF
 etc.

K

Capacitance Tolerances
 K = ±10%

--

Terminal Code
 -- = Male Terminal
 JE = Female Terminal

Medium Power Film Capacitors

FFLC (RoHS Compliant)



ELECTRICAL CHARACTERISTICS

Climatic Category	40/85/56 (IEC 60068)	
Test Voltage Between Terminals	@ 25°C: 1.5 x U _{Ndc} for 10s	
Test Voltage Between Terminals and Case	@ 25°C: @ 4 kVrms @ 50Hz for 1 min.	
Capacitance range C _n	1120µF to 8800µF (other values available upon request)	
Tolerance on C _n	±10%	
Rated DC voltage V _{Ndc}	680 to 1200 V	
FFLC overvoltage:	(V _s): V _s = 2 V _{Ndc} and limited at 1800V	
Maximum overvoltage	Peak value	Maximum duration
	1.67 V _{Ndc}	100 ms 1 time per week
	1.25 V _{Ndc}	100 ms 1 time per day
	1.1 V _{Ndc}	1 min 1 time per day
Maximum rms current I _{rms} max	140 Arms to 300 Arms	
Stray inductance L _s *	28 nH to 40 nH	
Dielectric	Polypropylene	

RATINGS AND PART NUMBER REFERENCE

Part Number	Capacitance (µF)	Height mm (in)	Width mm (in)	I _{rms} (A)	L _s * (nH)	R _s (mΩ)	R _{th} (°C/W)	Typical Weight (g)
U_{Ndc} 680 V (Voltage Code A)								
FFLC6A8807K--	8800	240 (9.449)	170 (6.693)	220	40	0.58	1.2	18000
FFLC6A7157K--	7150	240 (9.449)	145 (5.709)	230	38	0.50	1.2	13200
FFLC6A6507K--	6500	240 (9.449)	145 (5.709)	210	38	0.55	1.3	15500
FFLC6A5607K--	5600	170 (6.693)	170 (6.693)	140	35	0.88	1.8	15500
FFLC6A4557K--	4550	170 (6.693)	145 (5.709)	150	30	0.77	1.8	11300
FFLC6A4187K--	4180	240 (9.449)	95 (3.740)	300	35	0.34	1.0	10300
FFLC6A2667K--	2660	170 (6.693)	95 (3.740)	170	28	0.49	1.6	7300
U_{Ndc} 1000 V (Voltage Code L)								
FFLC6L5067K--	5060	240 (9.449)	170 (6.693)	250	40	0.61	1.2	17200
FFLC6L3207K--	3200	170 (6.693)	170 (6.693)	150	35	0.89	1.9	12400
FFLC6L4307K--	4300	240 (9.449)	145 (5.709)	300	38	0.52	1.1	15500
FFLC6L2737K--	2730	170 (6.693)	145 (5.709)	170	30	0.75	1.6	11300
FFLC6L2537K--	2530	240 (9.449)	95 (3.740)	300	35	0.36	0.8	10300
FFLC6L1607K--	1600	170 (6.693)	95 (3.740)	170	28	0.51	1.2	7300
U_{Ndc} 1200 V (Voltage Code U)								
FFLC6U3527K--	3520	240 (9.449)	170 (6.693)	250	40	0.71	1.2	18800
FFLC6U2247K--	2240	170 (6.693)	170 (6.693)	150	35	1.1	1.9	12700
FFLC6U3007K--	3000	240 (9.449)	145 (5.709)	300	38	0.60	1.1	15500
FFLC6U1907K--	1900	170 (6.693)	145 (5.709)	170	30	0.87	1.6	11300
FFLC6U1757K--	1750	240 (9.449)	95 (3.740)	300	35	0.41	0.8	10300
FFLC6U1127K--	1120	170 (6.693)	95 (3.740)	170	28	0.59	1.2	7300

*Very low stray inductance for high frequency applications on request.

Dimensions millimeters (inches)

LIFETIME EXPECTANCY vs HOT SPOT TEMPERATURE AND VOLTAGE

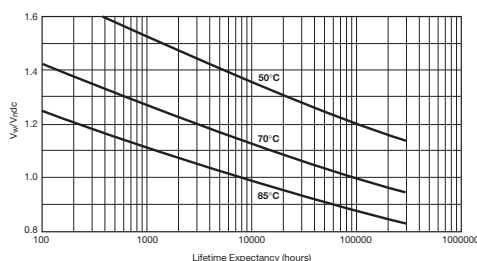

V_w: permanent working or operating DC-voltage.

HOT SPOT CALCULATION

See Hot Spot Temperature, page 3.

$$\theta_{\text{hot spot}} = \theta_{\text{ambient}} + (P_d + P_t) \times R_{\text{th}}$$

with P_d (Dielectric losses) = $Q \times \text{tg}\delta_0$
 $\Rightarrow [\frac{1}{2} \times C_n \times (V_{\text{peak to peak}})^2 \times f] \times (2 \times 10^{-4})$

$$P_t \text{ (Thermal losses)} = R_s \times (I_{\text{rms}})^2$$

where C_n in Farad I_{rms} in Ampere f in Hertz
 V in Volt R_s in Ohm θ in °C
 R_{th} in °C/W

Medium Power Film Capacitors

FSM (FSN RoHS Compliant)

New Design can use FFV Range



APPLICATIONS

Recovery capacitor for G.T.O. switching (secondary snubber or clamp capacitor).
High current DC filtering.

FEATURES

Metallized polypropylene dielectric specially treated to withstand high DC voltage stresses up to 85°C.
Controlled self-healing.
Internal geometry and connections specially developed for high currents (I_{rms} up to 100 A).
No liquid impregnant.
Special metallization for DC voltage and high currents.

PACKAGING MATERIAL

Self-extinguishing rectangular plastic case (in accordance with UL 94 VO) (12 kV/50 Hz isolation).
Filled with thermosetting resin.
M8 outputs.
Fixing in two planes.
Vibrations and shocks resistant to IEC 60077.
Average weight 0.95 kg.

Check for up-to-date CV Tables at <http://www.avx.com/docs/catalogs/filmcaps.pdf>

DIMENSIONS

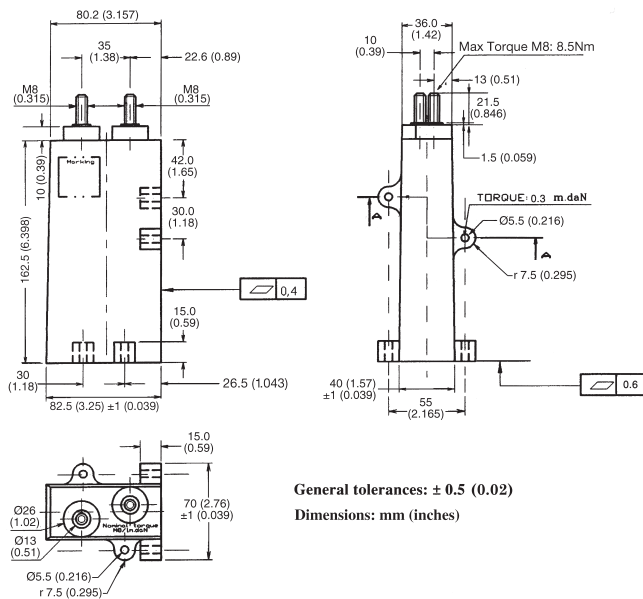

ELECTRICAL CHARACTERISTICS

Climatic category	40/085/56
Working temperature	-40°C to +85°C (according to the power to be dissipated)
Capacitance range C _n	20µF to 54µF
Tolerance on C _n	±10%
Rated DC voltage V _n dc	750 to 1350 V
Allowable overvoltages	V _s = 1.1 V _n dc – 1/3 of the time 1.3 V _n dc – 1 min./day 2 V _n dc – 100 ms/day for V _n dc = ≤ 1150 V 1.75 V _n dc – 100 ms/day for V _n dc = 1350 V
DC test voltage between 10s at 20°C ± 15°C terminals	V _e dc – 1.5 V _n dc (IEC 61071)
RMS current	I _{rms} max. = 65 to 105 A
Impulse current	I _{2,t} max. = 100 to 270 A ² s
Tangent of loss angle	Tgδ: see table of values
Series inductance L _s	≤ 25 nH
Thermal resistance	R _{th} ambient/hot spot = 9.2°C/W R _{th} case/hot spot = 3.3°C/W
Dielectric	Polypropylene

MARKING

Logo TPC
FSM
Capacitance and tolerance in clear
Nominal voltage in clear
RMS current in clear
Date of manufacture (IEC coding)

HOW TO ORDER

FSM	2	6	A	0546	K	--
Series FSM = Standard FSN = RoHS Compliant	Case Size 2 = Standard	Dielectric 6 = Polypropylene	Voltage Code A = 750Vdc C = 900Vdc L = 1000Vdc U = 1150Vdc V = 1350Vdc	Capacitance Code 0 + pF code 0546 = 54µF 0336 = 33µF 0206 = 20µF etc.	Capacitance Tolerances K = ±10%	Voltage Range -- = Standard (Male Threaded)

Medium Power Film Capacitors

FSM (FSN RoHS Compliant)

New Design can use FFV Range



1) RECOVERY OF G.T.O. SWITCHING ENERGY

Typical application

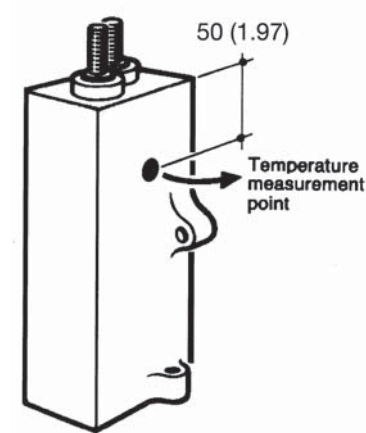
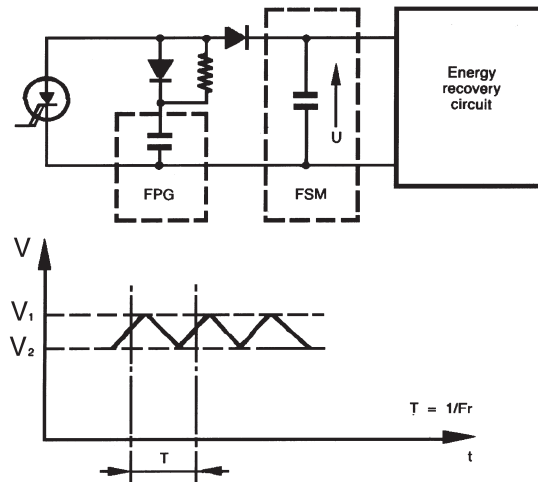

Choice of voltage:

$$V_1 \leq V_{n,dc}$$

Repetitive surge:

$$1.1 V_{n,dc} - 1/3 \text{ of the time}$$

Non-repetitive surge:

$$1.3 V_{n,dc} - 1 \text{ min./day}$$

Occasional max. surge:

$$2 V_{n,dc} - 100 \text{ ms/day for } V_{n,dc} \leq 1150 \text{ V}$$

$$1.75 V_{n,dc} - 100 \text{ ms/day for } V_{n,dc} = 1350 \text{ V}$$

RMS current limits:

The currents given in the tables are maximum. The thermal limits of the dielectric (85°C) must be respected.

The self-heating can be calculated from the series resistance, $Tg\delta$ and the thermal resistance given in the table of values

$$\Delta\theta = P \times R_{th} \leq 85^\circ\text{C} - \theta_{\text{ambient}}$$

R_{th} : is given for still air with the capacitor not being subjected to any other heat source.

$$P = (I_{rms})^2 \times R_s + \frac{\pi}{2} \times C (V_1 - V_2)^2 \times f_r \times 10^{-4}$$

Temperature measuring point*

Measurement of the case temperature (θ_B) together with the losses gives the temperature of the hot spot.

$$\theta = (R_{thB} \times P) + \theta_B \leq 85^\circ\text{C}$$

*Important for series/parallel operations.

Important

Due to the modular nature of this capacitors series parallel assemblies can be made to increase the capacitance and/or voltage.

Ensure that suitable sized connections are used so that the capacitors will not be overheated. The inductance of the connections must be low enough to ensure equal current sharing of capacitors in parallel.

For series assemblies, connect resistor across each capacitor. Optimal resistance value will be:

$$R \# 30 \text{ M}\Omega/\text{C in } \mu\text{F} \\ (1.5 \text{ M}\Omega \text{ for } C = 20 \mu\text{F}).$$

2) DC FILTERING

Nominal Capacitance

RATINGS AND PART NUMBER REFERENCE – POLYESTER DIELECTRIC

Part Number	Capacitance (μF)	$V_{n,dc}$ (V)	I_{rms} max.* (A)	$(I^2.t)$ max. (A^2s)	$Tg\delta$ ($f \rightarrow \text{kHz}$) (10^{-4})	R_s ($\text{m}\Omega$)	Typical Weight (g)
FSM26A0546K--	54	750	105	270	2 + 3.4 f	1	9500
FSM26C0446K--	42	900	100	220	2 + 2.8 f	1.05	9500
FSM26L0336K--	33	1000	95	170	2 + 2.3 f	1.1	9500
FSM26U0286K--	28	1150	85	150	2 + 2 f	1.15	9500
FSM26V0206K--	20	1350	65	100	2 + 1.6 f	1.25	9500

*Function of power dissipation

Medium Power Film Capacitors

FSB (RoHS Compliant)

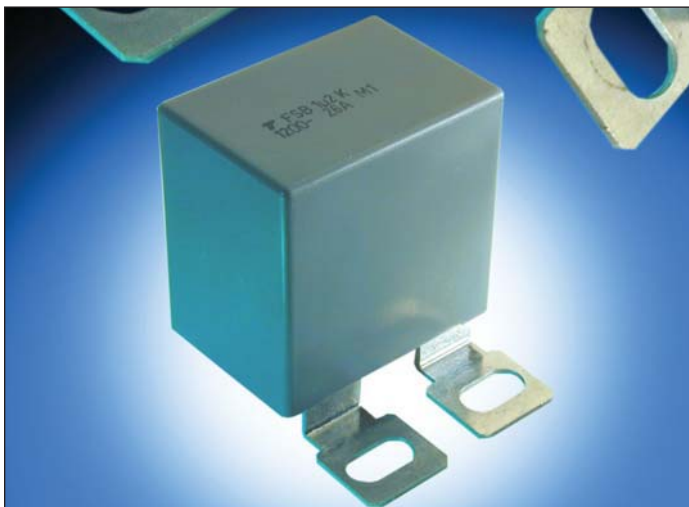

GENERAL DESCRIPTION

Metallized polypropylene dielectric capacitor with controlled self-healing.

Reinforced metallization developed for high impulse currents.

APPLICATIONS

- IGBT protection
- IGBT clamping

PACKAGING MATERIAL

- Plastic case backfilled with thermosetting resin

Check for up-to-date CV Tables at <http://www.avx.com/docs/catalogs/filmcaps.pdf>

HOW TO ORDER

FSB	1	6	U	0154	J	--
Series	Case Size	Dielectric	Voltage Code	Capacitance Code	Capacitance Tolerances	Voltage Range
	1 = PO Style 2 = 18 Style 3 = 19 Style 4 = 26 style 5 = R28 Style (2 terminal or 4 terminal)	6 = Polypropylene	B = 850Vdc U = 1200Vdc M = 1600Vdc N = 2000Vdc	0 + pF code 0154 = 0.15µF 0334 = 0.33µF 0255 = 2.5µF etc.	J = ± 5% K = ±10% (Case size 6 only)	-- = 2 Terminal JC = 4 Terminal (Case Size 5 option only)

ELECTRICAL CHARACTERISTICS

Capacitance Range C_n	0.10µF to 2.5µF
Tolerance on C_n	±5%: FSB1...5 ±10%: FSB6
Rated DC Voltage V_{ndc}	850 to 2000 V
Stray Inductance	≤ 25 nH
RMS Current	I_{rms} max. = up to 28A The currents shown in the tables are maximum. It is necessary to maintain operation within the maximum temperature of the dielectric 85°C. See "Hot spot temperature calculation"
Insulation Resistance	$R_i \times C \geq 30,000$ s
Impulse Current	$I^2.t$ max. = up to 1.69 A ² s Spikes or peak currents in the capacitors may cause a deterioration of the bonding between the metallization and the connections. These bonds are capable of withstanding only a limited amount of energy for each spike. The table shows the maximum energy permitted in the form ($I^2.t$), where I is in Amperes, and t is in seconds.
Note: The formula ($I^2.t$) replaces dv/dt which is less easy to use as it is not an expression of energy ($I = C.dv/dt$). This type of capacitor has been designed to withstand high ($I^2.t$) values.	
Variation of Capacitance with Temperature	$\frac{\Delta C}{C} \leq \pm 2\%$ between -40 and +85°C
Climatic Category	40/085/56 (IEC 68)
Test Voltage Between Terminals @ 25°C	1.6 V_{ndc} during 10s
Withstanding Voltage Between Terminals and Case @ 25°C	@ 3 kVrms @ 50Hz during 1 min.

GENERAL DESCRIPTION

STYLE: P0; 18; 19; 26; R68
ALL CASE SIZES
2 TERMINALS VERSION

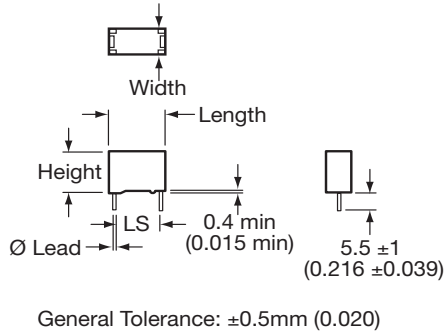

STYLE: R68
CASE SIZE 5 ONLY
4 TERMINALS VERSION

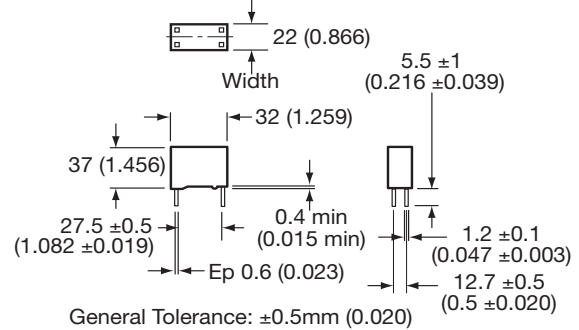

DIMENSIONS: millimeters (inches)

Case Size	Case Style	Length mm ± 0.40 (inches)	Width mm ± 0.40 (inches)	Height mm ± 0.30 (inches)	Dimensions lead mm $+10\%$ -0.05 (inches)	LS mm ± 0.40 (inches)
1	P0	31.1 (1.230)	13.0 (0.051)	22.4 (0.880)	\varnothing 0.80 (0.031)	27.5 (1.083)
2	18	31.1 (1.230)	14.6 (0.580)	25.7 (1.010)	\varnothing 0.80 (0.031)	27.5 (1.083)
3	19	31.1 (1.230)	17.3 (0.068)	29.8 (1.170)	\varnothing 0.80 (0.031)	27.5 (1.083)
4	26	31.1 (1.230)	20.8 (0.820)	31.3 (1.230)	\varnothing 1.00 (0.039)	27.5 (1.083)
5	R68 2 Terminals Version	32.5 (1.280)	22.0 (0.870)	37.0 (1.460)	\varnothing 1.00 (0.039)	27.5 (1.083)
	R68 4 Terminals Version	32.5 (1.280)	22.0 (0.870)	37.0 (1.460)	1.20 x 0.60 (0.047 x 0.023)	27.5 (1.083)

RATINGS AND PART NUMBER REFERENCE

Part Number	Capacitance (μF)	Case Style	(I^2t) (A^2s)	I _{rms} (A)	R _s (m Ω)	R _{th} (hotspot/amb.)	Typical Weight (g)
$U_{Ndc} = 1200\text{V}$ $V_{peak} = 1600\text{V}$ $V_{rms} = 560\text{V}$ $V_s = 2000\text{V}$ (Voltage Code U)							
FSB16U0154J--	0.15	P0	0.05	3	14.3	45.9	15
FSB26U0274J--	0.27	18	0.15	7.6	8.4	36.8	20
FSB36U0394J--	0.39	19	0.31	11	6.2	32.2	25
FSB46U0474J--	0.47	26	0.41	12	5.6	29.4	32
FSB56U0684J--	0.68	R68 (2 terminals)	0.94	12	3.8	23.7	40
FSB56U0684JJC	0.68	R68 (4 terminals)	0.94	16.7	3.8	23.7	40
$U_{Ndc} = 1600\text{V}$ $V_{peak} = 2000\text{V}$ $V_{rms} = 630\text{V}$ $V_s = 2300\text{V}$ (Voltage Code M)							
FSB16M0134J--	0.13	P0	0.05	4.6	13.3	44.9	15
FSB26M0184J--	0.18	18	0.1	6.4	9.9	35.9	20
FSB36M0244J--	0.24	19	0.18	8.5	7.8	32.4	25
FSB46M0334J--	0.33	26	0.35	11.7	5.6	28.6	32
FSB56M0434J--	0.43	R68 (2 terminals)	0.59	12	4.6	23.8	40
FSB56M0434JJC	0.43	R68 (4 terminals)	0.59	15.2	4.6	23.8	40
$U_{Ndc} = 2000\text{V}$ $V_{peak} = 2400\text{V}$ $V_{rms} = 700\text{V}$ $V_s = 2600\text{V}$ (Voltage Code N)							
FSB16N0104J--	0.1	P0	0.05	4.2	14.3	44.6	15
FSB26N0134J--	0.13	18	0.08	5.5	11.3	35.7	20
FSB36N0184J--	0.18	19	0.15	7.6	8.5	32.1	25
FSB46N0224J--	0.22	26	0.22	9.3	6.8	29.1	32
FSB56N0304J--	0.3	R68 (2 terminals)	0.41	12	5.3	23.8	40
FSB56N0304JJC	0.3	R68 (4 terminals)	0.41	12.7	5.3	23.8	40

Medium Power Film Capacitors

FSB (RoHS Compliant)



CASE SIZE 6

Plastic case resin filled
Dimensions: millimeters (inches)

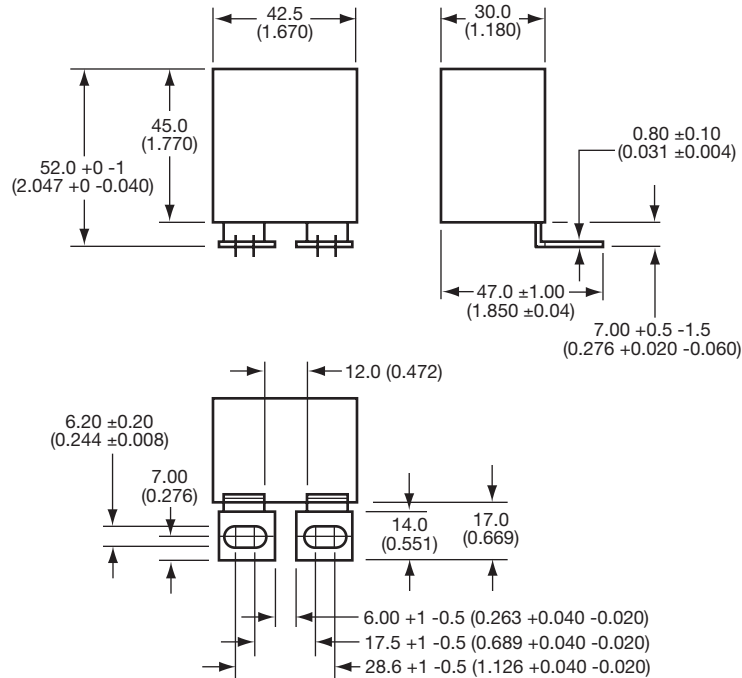

GENERAL TOLERANCES: ±0.50mm (±0.020 inches)

RATINGS AND PART NUMBER REFERENCE

Part Number	Capacitance (μF)	(I ² t) (A ² s)	I _{rms max.} (A)	R _s (mΩ)	R _{th} (°C/W)	Typical Weight (g)
FSB 850V V_{Ndc} = 850V V_{peak} = 1200V V_{rms} = 450V V_S = 1500V (Voltage Code B)						
FSB66B0205K--	2	0.99	25	3.4	19.1	87
FSB66B0225K--	2.2	1.19	28	3.1	18.6	87
FSB66B0255K--	2.5	1.54	28	2.7	17.8	87
FSB 1200V V_{Ndc} = 1200V V_{peak} = 1600V V_{rms} = 560V V_S = 2000V (Voltage Code U)						
FSB66U0105K--	1	1.47	25	3.6	17.2	87
FSB66U0125K--	1.2	1.69	26	3.4	17.5	87
FSB66U0155K--	1.5	1	26	3.4	17.5	87
FSB 2000V V_{Ndc} = 2000V V_{peak} = 2400V V_{rms} = 700V V_S = 2600V (Voltage Code N)						
FSB66N0474K--	0.47	0.41	22	6.3	19.4	87
FSB66N0564K--	0.56	0.62	23	5.2	17.9	87
FSB66N0684K--	0.68	0.91	24	4.4	17.3	87

Medium Power Film Capacitors

FSB (RoHS Compliant)



STANDARDS

IEC 61071-1, IEC 61071-2: Power electronic capacitors

TANGENT OF LOSS ANGLE (TANδ₀) FOR POLYPROPYLENE DIELECTRIC

Polypropylene has a constant dielectric loss factor of 2x10⁻⁴ irrespective of temperature and frequency (up to 1 MHz).

IGBT SNUBBER

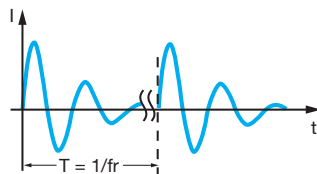
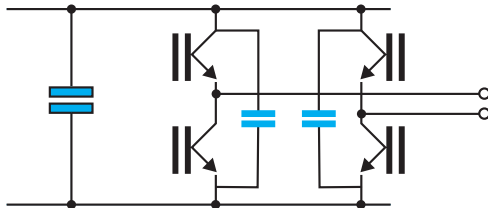

With

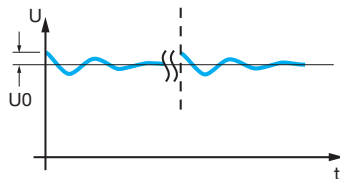

L = stray inductance IGBT + capacitor

R = serial resistance IGBT + capacitor

HOT SPOT TEMPERATURE CALCULATION

See *Hot Spot Temperature*, page 3.

$$\theta_{\text{hot spot}} = \theta_{\text{ambient}} + (P_d + P_t) \times R_{\text{th}}$$

with P_d (Dielectric losses) = $Q \times \text{tg}\delta_0$
 $\Rightarrow [\frac{1}{2} \times C_n \times (V_{\text{ripple peak to peak}})^2 \times f] \times (2 \times 10^{-4})$

$$P_t \text{ (Thermal losses)} = R_s \times (I_{\text{rms}})^2$$

R_{th} : $R_{\text{th ambient / hot spot}}$ in °C/W

where C_n in Farad I_{rms} in Ampere f in Hertz
 V in Volt R_s in Ohm θ in °C

Due to the design of the capacitor and its technology, the thermal impedance between the terminations and the core of the capacitor is low, it is necessary to take care that the capacitor is never overheated by use of wrongly sized connections.

Do not use the capacitor as a heat sink.

Due to the complexity of the IGBT / capacitor thermal exchanges, we recommend that thermal measurements shall be made on the different components. We would be pleased to advise you on specific applications.

WORKING TEMPERATURE

(according to the power to be dissipated) -40°C to +85°C

MARKING

TPC logo

Capacitance and tolerance in clear

Nominal DC voltage in clear

RMS current in clear

Date of manufacture (IEC coding)

$$I_{\text{eff}} = \sqrt{\left[\frac{C\beta_0^2 \times U_0}{2j\beta} \right]^2 \times \frac{1}{T} \times \left[\frac{e^{-2\alpha \times T}}{\beta^2 + \alpha^2} \times [\beta \sin(2\beta \times T) - \alpha \times \cos(2\beta \times T)] + \frac{1}{\alpha} \times e^{-2\alpha \times T} + \frac{\alpha}{\beta^2 + \alpha^2} - \frac{1}{\alpha} \right]}$$

with $\beta_0 = \sqrt{\frac{1}{LC}}$; $\alpha = \frac{R}{2L}$; $\beta = \sqrt{\beta_0^2 - \alpha^2}$

Medium Power Film Capacitors

FSV (RoHS Compliant)

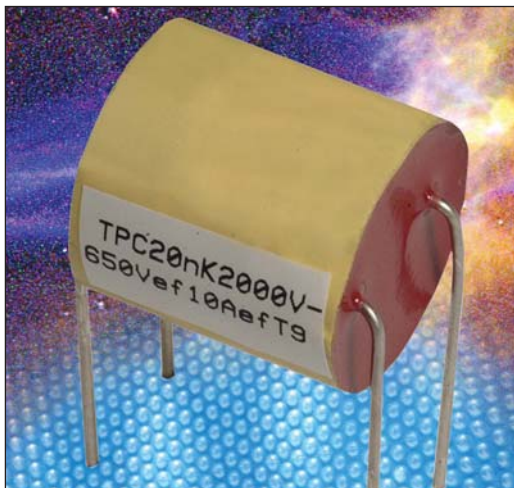

GENERAL DESCRIPTION

Metallized dielectric capacitor and metal foil, low serial inductance and high RMS current.

APPLICATIONS

- Protection of semi conductors
- High frequency decoupling
- Tuning

PACKAGING MATERIAL

- Cylindrical with polyester tape wrapping, sealed with polyurethane resin
- Radial connections

[Check for up-to-date CV Tables at http://www.avx.com/docs/catalogs/filmcaps.pdf](http://www.avx.com/docs/catalogs/filmcaps.pdf)

DIMENSIONS

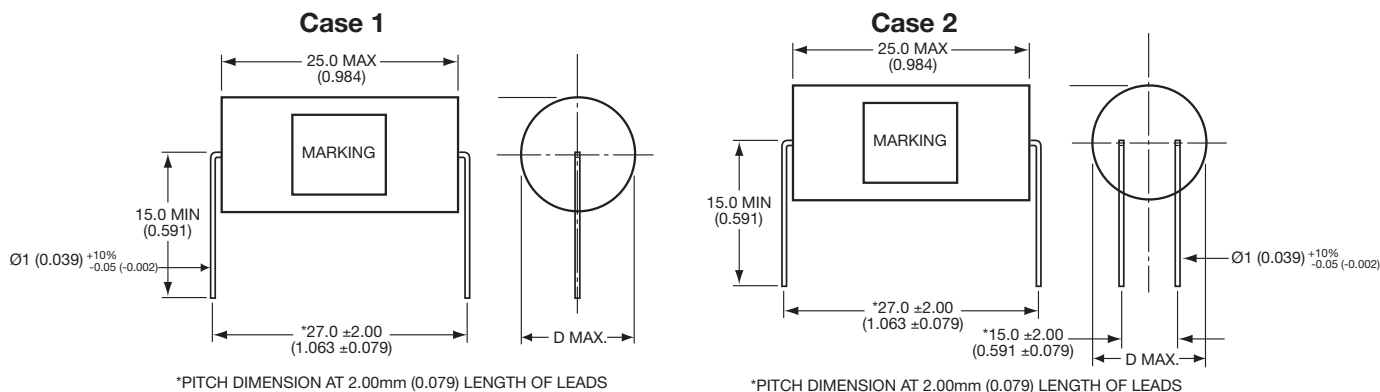

HOW TO ORDER

FSV	1	6	K	0683	K	--
Series	Case Size Case Size 1 Case Size 2	Dielectric 6 = Polypropylene	Voltage Code K = 600Vdc B = 800Vdc L = 1000Vdc U = 1200Vdc R = 1500Vdc N = 2000Vdc	Capacitance Code 0 = pF code 0683 = 0.068µF 0333 = 0.033µF 0203 = 0.020µF etc.	Capacitance Tolerances K = ±10%	Voltage Range -- = Standard

Medium Power Film Capacitors

FSV (RoHS Compliant)



ELECTRICAL CHARACTERISTICS

Capacitance Range Cn	0.010μF to 0.15μF
Tolerance on Cn	10%
Rated DC Voltage Vndc	600 to 2000 V
Rated AC Voltage	300 to 650 Vrms
Test Voltage	
between terminals @ 25°C	1.5 Vndc during 10s
High dV/dt	10000 V/μs
RMS Current	Irms max = up to 23A The currents shown in the tables are maximum. It is necessary to respect the thermal limits of the dielectric 85°C See "Hot spot temperature calculation"
Working Temperature	-40°C +85°C (according to the power to be dissipated)
Climatic Category	40/085/56 (IEC 60068)
Hot Spot Calculation	See <i>Hot Spot Temperature page 3</i> For all applications, the temperature in the hot spot capacitor must be lower than 85°C $\Theta_{\text{Hot spot}} = \Theta_{\text{ambient}} + (\tan\delta_0 \times Q + R_s I_{\text{rms}}^2) \times R_{\text{th}}$ With $\tan\delta_0 = 2 \cdot 10^{-4}$ Q in vars R_s in Ω I_{rms} in A R_{th} in °C/W
Dielectric	Polypropylene

RATINGS AND PART NUMBER REFERENCE

Part Number	Capacitance (μF)	D max. mm (in)	Irms A	Rs (mΩ)	Rth °C/W	Typical Weight (g)
FSV 600 V Vndc = 600V Vrms = 300V (Voltage Code K)						
FSV16K0683K--	0.068	22 (0.866)	10	2.5	35	15
FSV26K0104K--	0.10	25 (0.984)	15	2.1	25	25
FSV26K0154K--	0.15	30 (1.181)	23	1.8	17	25
FSV 800 V Vndc = 800V Vrms = 400V (Voltage Code B)						
FSV16B0473K--	0.047	22 (0.866)	10	2.6	33	15
FSV26B0683K--	0.068	25 (0.984)	15	2.2	23	25
FSV26B0823K--	0.082	28 (1.102)	18	2.1	21	25
FSV26B0104K--	0.100	30 (1.181)	23	1.9	16	25
FSV 1000 V Vndc = 1000V Vrms = 450V (Voltage Code L)						
FSV16L0333K--	0.033	22 (0.866)	8	2.8	31	15
FSV26L0473K--	0.047	25 (0.984)	12	2.3	22	25
FSV26L0683K--	0.068	30 (1.181)	17	2.0	16	25
FSV 1200 V Vndc = 1200V Vrms = 500V (Voltage Code U)						
FSV16U0223K--	0.022	22 (0.866)	7	3.2	34	15
FSV26U0333K--	0.033	25 (0.984)	10	2.2	23	25
FSV26U0473K--	0.047	30 (1.181)	14	2.1	16	25
FSV 1500 V Vndc = 1500V Vrms = 600V (Voltage Code R)						
FSV16R0153K--	0.015	22 (0.866)	5	3.5	34	15
FSV26R0223K-	0.022	25 (0.984)	8	2.8	22	25
FSV26R0333K-	0.033	30 (1.181)	12	2.2	16	25
FSV 2000 V Vndc = 2000V Vrms = 650V (Voltage Code N)						
FSV16N0103K--	0.010	22 (0.866)	5	3.4	34	15
FSV26N0153K--	0.015	25 (0.984)	7	2.9	21	25
FSV26N0203K--	0.020	27 (1.063)	10	2.4	16	25
FSV26N0223K--	0.022	30 (1.181)	11	2.4	14	25

Medium Power Film Capacitors

FPX/FPY (RoHS Compliant)



PROTECTION



Check for up-to-date CV Tables at <http://www.avx.com/docs/catalogs/filmcaps.pdf>

DIMENSIONS

Plastic Case Style M6 / 6 or M8 / 8

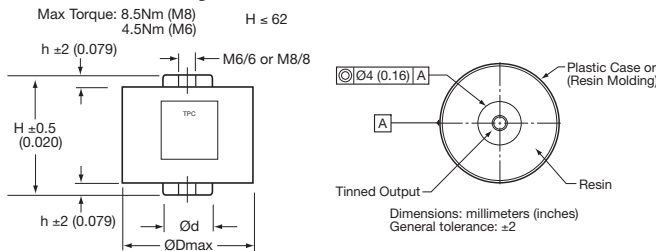

Plastic Case Style M8 / 10

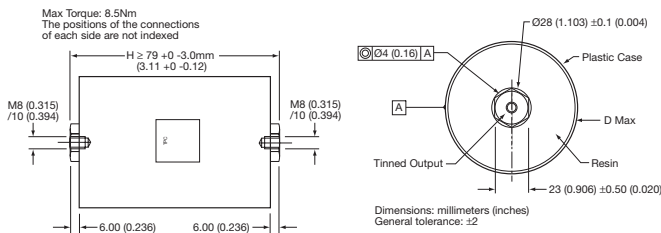

MARKING

- Logo
- Withstanding surge voltage
- Capacitance and tolerance in clear
- Nominal DC voltage in clear
- RMS current in clear
- Date of manufacture (IEC coding)

HOW TO ORDER

FPX	6	6	N	0105	J	--
Series FPX = Standard FPY = RoHS Compliant	Case Size Case Size 6 Case Size 8 (See Case Style)	Dielectric 6 = Polypropylene	Voltage Code N = 2000V P = 2500V X = 3500V Z = 4500V Y = 4600V	Capacitance Code 0 + pF code 0105 = 1.0µF 0335 = 3.5µF 0504 = 0.5µF etc.	Capacitance Tolerances K = ±5%	Terminal Code -- = Standard

APPLICATIONS

- Protection of thyristors.
- Protection of gate turn-off thyristor (G.T.O.).
- Clamping (Secondary snubber).

TECHNOLOGY

- Metallized polypropylene dielectric capacitor with controlled self-healing.
- Reinforced metallization developed for high impulse currents.
- Axial connections specially developed to reduce series inductance and to provide rigid mechanical mounting.

PACKAGING MATERIAL

- Cylindrical in plastic case filled with thermosetting resin.
- Outputs: threaded inserts either M6 or M8.

HOT SPOT TEMPERATURE CALCULATION

See Hot Spot Temperature page 3.

$$\theta_{\text{hot spot}} = \theta_{\text{terminals}} + (P_d + P_t) \times R_{th}$$

with

$$P_d \text{ (Dielectric losses)} = Q \times \text{tg}\delta_0$$

$$\Rightarrow [\frac{1}{2} \times C_n \times (V_{\text{peak to peak}})^2 \times f] \times (2 \times 10^{-4})$$

$$P_t \text{ (Thermal losses)} = R_s \times (I_{\text{rms}})^2$$

where

- C_n in Farads
- V in Volts
- I_{rms} in Amperes
- R_s in Ohms
- f in Hertz
- θ in °C
- R_{th} in °C/W

Due to the design of the capacitor and its technology, the thermal impedance between the terminations and the core of the capacitor is low, it is necessary to take care that the capacitor is never overheated by use of incorrect sized connections.

In the case where the series diodes are screwed to the capacitor, cooling of the diodes must be taken in account.

Do not use the capacitor as a heat sink.

Due to the complexity of the diode/capacitor thermal exchanges, we recommend that thermal measurements shall be made on the different components. We would be pleased to advise you on specific problems.

WORKING TEMPERATURE

(according to the power to be dissipated) -40°C to +85°C

Medium Power Film Capacitors

FPX/FPY (RoHS Compliant)



ELECTRICAL CHARACTERISTICS

Capacitance range C_n	0.5 μ F to 6 μ F
Tolerance on C_n	$\pm 5\%$
Rated DC voltage $V_{n,dc}$	1000 to 3000 V
Peak voltage V_{peak}	1600 to 4000 V
Allowable overvoltage V_s (for 10 s/day)	2000 to 4600 V
Stray inductance	5 to 20 nH
RMS current	I_{rms} max. = up to 160 A The currents shown in the tables are maximum. It is necessary to respect the thermal limits of the dielectric 85°C see "Hot spot temperature calculation"
Insulation resistance	$R_i \times C \geq 30,000$ s
Impulse current	$I^2.t$ maxi. = up to 729 A ² .s Spikes or peak currents in the capacitors may cause a deterioration of the bonding between the metallization and the connections. These bonds are capable of withstanding only a limited amount of energy for each spike. The table shows the maximum energy permitted in the form ($I^2.t$), where I is in Ampere, and t is in seconds.
Note: The formula ($I^2.t$) replaces dV/dt which is less easy to use as it is not an expression of energy ($I = C.dV/dt$). This type of capacitor has been designed to withstand high ($I^2.t$) values.	
Variation of capacitance with temperature	$\frac{\Delta C}{C} \leq \pm 2\%$ between -40 and 85°C
Climatic category	40/085/56 (IEC 60068)
Test voltage between terminals @ 25°C	V_s for 10s
Test voltage between terminals and case @ 25°C (Type test)	@ 7 kVrms @ 50 Hz for 1 min.
Dielectric	Polypropylene

PROTECTION

APPLICATIONS NOTES

G.T.O.

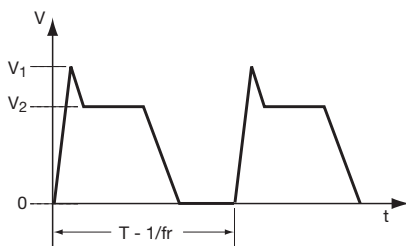

Choice of voltage: $V_1 \leq V_{peak}$
 $V_2 \leq V_{n,dc}$

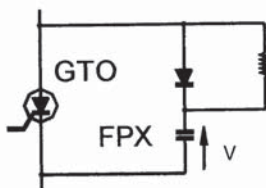

Nominal DC voltage ($V_{n,dc}$) and peak voltage (V_{peak}) are given in the tables.

THYRISTOR

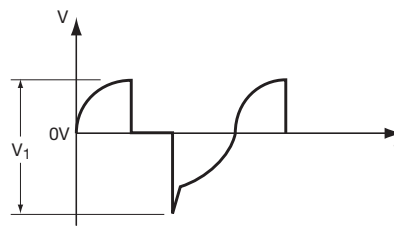

Choice of voltage: $V_1 \leq V_{peak}$
Note that V_1 is the voltage peak to peak and cannot be symmetrical vs 0 V

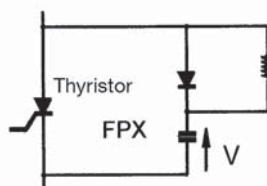

Peak voltage is given in the tables.

CLAMPING

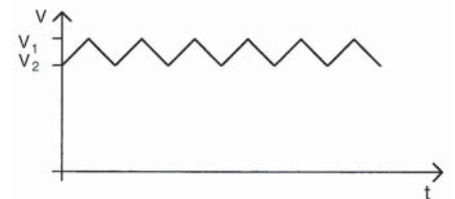

Choice of voltage: $V_1 \leq V_{peak}$
 $V_2 \leq V_{n,dc}$

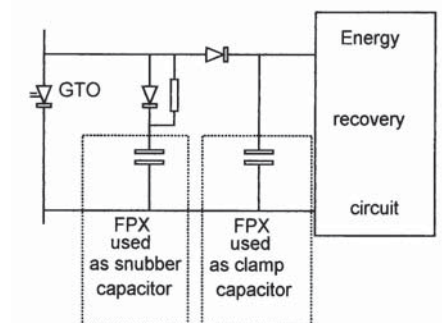

Nominal DC voltage ($V_{n,dc}$) and peak voltage (V_{peak}) are given in the tables.

Medium Power Film Capacitors

FPX/FPY (RoHS Compliant) Table of Values



PROTECTION

Dimensions: millimeters (inches)

Part Number	Cn (μF)	Dimensions					I ² t max. (A ² .s)	I _{rms} max. (A)	Rs (mΩ)	Rth (°C/W)	Typical Weight (g)
		Case Style	H* ±0.5 (±0.020)	h ±2 (±0.079)	D max.	d ±0.5 (±0.020)					
FPX 2000V V_{Ndc} = 1000V V_{peak} = 1600V V_{rms} = 560V V_s = 2000V (Voltage Code N)											
FPX66N0105J--	1	Plastic case M6/6	52 (2.072)	5 (0.197)	40 (1.575)	18 (0.709)	2	15	2.4	14	120
FPX86N0205J--	2	Plastic case M8/8	52 (2.072)	5 (0.197)	60 (2.362)	22 (0.866)	8	30	1.2	6.1	190
FPX86N0305J--	3	Plastic case M8/8	52 (2.072)	5 (0.197)	72 (2.835)	22 (0.866)	18	45	0.9	4.5	260
FPX86N0355J--	3.5	Plastic case M8/8	52 (2.072)	5 (0.197)	72 (2.835)	22 (0.866)	25	50	0.85	4.5	260
FPX86N0405J--	4	Plastic case M8/8	52 (2.072)	5 (0.197)	82 (3.228)	22 (0.866)	32	60	0.75	3.5	320
FPX86N0505J--	5	Plastic case M8/8	52 (2.072)	5 (0.197)	82 (3.228)	22 (0.866)	50	70	0.65	2.5	320
FPX 2500V V_{Ndc} = 1300V V_{peak} = 2000V V_{rms} = 700V V_s = 2500V (Voltage Code P)											
FPX66P0504J--	0.5	Plastic case M6/6	52 (2.072)	5 (0.197)	40 (1.575)	18 (0.709)	1	15	3	14	120
FPX86P0105J--	1	Plastic case M8/8	52 (2.072)	5 (0.197)	60 (2.362)	22 (0.866)	3	20	2.3	10.5	190
FPX86P0155J--	1.5	Plastic case M8/8	52 (2.072)	5 (0.197)	60 (2.362)	22 (0.866)	7	30	1.5	6.1	190
FPX86P0205J--	2	Plastic case M8/8	52 (2.072)	5 (0.197)	72 (2.835)	22 (0.866)	12.7	40	1.1	4.5	260
FPX86P0255J--	2.5	Plastic case M8/8	52 (2.072)	5 (0.197)	72 (2.835)	22 (0.866)	20	60	0.89	3.7	260
FPX86P0305J--	3	Plastic case M8/8	52 (2.072)	5 (0.197)	82 (3.228)	22 (0.866)	28	60	0.85	3.2	320
FPX86P0355J--	3.5	Plastic case M8/8	52 (2.072)	5 (0.197)	82 (3.228)	22 (0.866)	39	65	0.78	2.9	320
FPX 3500V V_{Ndc} = 2000V V_{peak} = 2400V V_{rms} = 850V V_s = 3500V (Voltage Code X)											
FPX86X0205J--	2	Plastic case M8/8	62 (2.441)	5 (0.197)	72 (2.835)	22 (0.866)	23	41	1.24	6.1	310
FPX86X0305J--	3	Plastic case M8/8	62 (2.441)	5 (0.197)	92 (3.622)	22 (0.866)	50	62	0.92	3.9	475
FPX86X0355J--	3.5	Plastic case M8/8	62 (2.441)	5 (0.197)	92 (3.622)	22 (0.866)	70	72	0.83	3.4	475
FPX86X0405J--	4	Plastic case M8/8	62 (2.441)	5 (0.197)	92 (3.622)	22 (0.866)	85	80	0.78	3.1	475
FPX 2000V V_{Ndc} = 1000V V_{peak} = 1600V V_{rms} = 560V V_s = 2000V (Voltage Code Z)											
FPX86Z0904J--	0.9	Plastic case M8/8	62 (2.441)	5 (0.197)	72 (2.835)	22 (0.866)	15	40	1.5	6.2	310
FPX86Z0105J--	1	Plastic case M8/8	62 (2.441)	5 (0.197)	72 (2.835)	22 (0.866)	15	38	1.4	6.2	310
FPX86Z0205J--	2	Plastic case M8/8	62 (2.441)	5 (0.197)	92 (3.622)	22 (0.866)	70	75	0.85	3.1	475
FPX 4600V V_{Ndc} = 3000V V_{peak} = 4000V V_{rms} = 1400V V_s = 4600V (Voltage Code Y)											
FPX86Y0504J--	0.5	Plastic case M8/8	62 (2.441)	5 (0.197)	72 (2.835)	22 (0.866)	7	40	1.7	12	310
FPX86Y0684J--	0.68	Plastic case M8/8	62 (2.441)	5 (0.197)	72 (2.835)	22 (0.866)	14	35	1.59	6.2	310
FPX86Y1254J--	1.25	Plastic case M8/8	62 (2.441)	5 (0.197)	92 (3.622)	22 (0.866)	50	65	1	3.3	475
FPX86Y0155J--	1.5	Plastic case M8/10	79 (3.110)	6 (0.236)	98 (3.858)	–	32	60	1.4	8.3	630
FPX86Y0175J--	1.7	Plastic case M8/10	79 (3.110)	6 (0.236)	98 (3.858)	–	40	70	1.3	7.4	630
FPX86Y0205J--	2	Plastic case M8/10	79 (3.110)	6 (0.236)	98 (3.858)	–	56	80	1.1	6.3	630
FPX86Y0255J--	2.5	Plastic case M8/10	118 (4.646)	6 (0.236)	98 (3.858)	–	200	130	0.8	1.1	1020
FPX86Y0275J--	2.7	Plastic case M8/10	118 (4.646)	6 (0.236)	98 (3.858)	–	232	140	0.7	1.1	1020
FPX86Y0305J--	3	Plastic case M8/10	143 (5.630)	6 (0.236)	98 (3.858)	–	128	100	0.9	1.5	1280
FPX86Y0355J--	3.5	Plastic case M8/10	143 (5.630)	6 (0.236)	98 (3.858)	–	170	110	0.8	1.4	1280
FPX86Y0405J--	4	Plastic case M8/10	143 (5.630)	6 (0.236)	98 (3.858)	–	224	115	0.8	1.4	1280
FPX86Y0455J--	4.5	Plastic case M8/10	163 (6.417)	6 (0.236)	98 (3.858)	–	522	120	0.6	1.7	1500
FPX86Y0505J--	5	Plastic case M8/10	163 (6.417)	6 (0.236)	98 (3.858)	–	600	130	0.6	1.7	1500
FPX86Y0605J--	6	Plastic case M8/10	163 (6.417)	6 (0.236)	98 (3.858)	–	729	160	0.5	1.7	1500

* Tol: +0 / -3mm for H ≥ 118mm

PROTECTION



Metallized polypropylene dielectric capacitor with controlled self-healing.

Reinforced metallization on margins developed for high impulse currents.

Axial connections specially developed to reduce series inductance and to provide rigid mechanical mounting.

APPLICATIONS

Protection of gate turn-off thyristor (G.T.O.).

Medium frequency tuning.

HOT SPOT TEMPERATURE CALCULATION

See *Hot Spot Temperature* page 3.

$$\theta_{\text{hot spot}} = \theta_{\text{terminals}} + (P_d + P_t) \times R_{\text{th}}$$

with

$$P_d \text{ (Dielectric losses)} = Q \times \text{tg}\delta_0$$

$$\Rightarrow \left[\frac{1}{2} \times C_n \times (V_{\text{peak to peak}})^2 \times f \right] \times (2 \times 10^{-4})$$

$$P_t \text{ (Thermal losses)} = R_s \times (I_{\text{rms}})^2$$

where

C_n in Farads

V in Volts

I_{rms} in Amperes

R_s in Ohms

f in Hertz

θ in °C

R_{th} in °C/W

Due to the design of the capacitor and its technology, the thermal impedance between the terminations and the core of the capacitor is low, it is necessary to take care that the capacitor is never overheated by use of incorrect sized connections.

In the case where the series diodes are screwed to the capacitor, cooling of the diodes must be taken in account.

Do not use the capacitor as a heat sink.

Due to the complexity of the diode/capacitor thermal exchanges, we recommend that thermal measurements shall be made on the different components. We would be pleased to advise you on specific problems.

WORKING TEMPERATURE

(according to the power to be dissipated) -40°C to +85°C



Check for up-to-date CV Tables at
<http://www.avx.com/docs/catalogs/filmcaps.pdf>

DIMENSIONS

millimeters (inches)

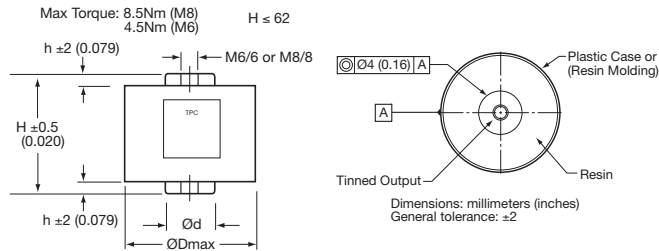

MARKING

- Logo
- Withstanding surge voltage
- Capacitance and tolerance in clear
- Nominal DC voltage in clear
- RMS current in clear
- Date of manufacture (IEC coding)

PACKAGING MATERIAL

- Cylindrical in either plastic case (preferred packaging) or a resin molding.
- Outputs: threaded inserts either M6 or M8.
- Filled with thermosetting resin.

HOW TO ORDER

FPG	8	6	R	0105	J	--
Series	Case Size	Dielectric	Voltage Code	Capacitance Code	Capacitance Tolerances	Terminal Code
FPG = Standard FPH = RoHS Compliant	Case Size 8	6 = Polypropylene	R = 1500V N = 2000V P = 2500V W = 2600V X = 3500V Z = 4500V Y = 4600V	0 + pF code 0105 = 1.0µF 0405 = 4.0µF 0604 = 0.6µF etc.	K = ±5%	-- = Standard

ELECTRICAL CHARACTERISTICS

Capacitance range C_n	0.12 μ F to 6 μ F
Tolerance on C_n	$\pm 5\%$
Rated DC voltage V_{ndc}	800 to 3000 V
Peak voltage V_{peak}	1200 to 4000 V
Allowable overvoltage V_s (for 10 s/day)	1500 to 4600 V
Nominal RMS voltage V_{ndc}	500 to 1400 V
Stray inductance	≈ 10 nH
RMS current	I_{rms} max. = up to 80 A The currents shown in the tables are maximum. It is necessary to respect the thermal limits of the dielectric 85°C see "Hot spot temperature calculation"
Insulation resistance	$R_i \times C \geq 30,000$ s
Impulse current	$I^2.t$ max. given in the tables Spikes or peak currents in the capacitors may cause a deterioration of the bonding between the metallization and the connections. These bonds are capable of withstanding only a limited amount of energy for each spike. The table shows the maximum energy permitted in the form ($I^2.t$), where I is in Ampere, and t is in seconds.
Note: The formula ($I^2.t$) replaces dV/dt which is less easy to use as it is not an expression of energy ($I = C.dV/dt$). This type of capacitor has been designed to withstand high ($I^2.t$) values.	
Variation of capacitance with temperature	$\frac{\Delta C}{C} \leq \pm 2\%$ between -40 and 85°C
Climatic category	40/085/56 (IEC 60068)
Test voltage between terminals @ 25°C	V_s during 10s
Test voltage between terminals and case @ 25°C (Type test)	@ 4 kVrms @ 50 Hz during 1 min.
Dielectric	Polypropylene

PROTECTION

APPLICATION NOTES

G.T.O. PROTECTION

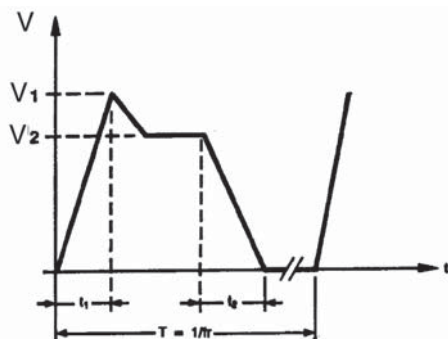

Choice of voltage: $V_1 \leq V_{peak}$
 $V_2 \leq V_{ndc}$
 Maximum overvoltage $\leq V_s$ (10 s/day)

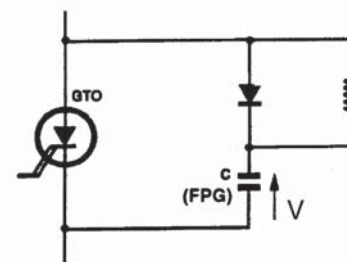

FPG: Snubber capacitor

Nominal DC voltage (V_{ndc}) and peak voltage (V_{peak}) are given in the table of values.

Medium Power Film Capacitors

FPG/FPH (RoHS Compliant) Table of Values



PROTECTION

Dimensions: millimeters (inches)

Part Number	Cn (μF)	Dimensions					I ² .t max. (A ² .s)	I _{rms} max. (A)	Rs (mΩ)	Rth (°C/W)	Typical Weight (g)
		Case Style	H* ±0.5 (±0.020)	h ±2 (±0.079)	D max.	d ±0.5 (±0.020)					
FPG 1500V V_{ndc} = 800V V_{peak} = 1200V V_{rms} = 500V V_s = 1500V (Voltage Code R)											
FPG66R0105J--	1	Plastic Case M6/6	52 (2.047)	5 (0.197)	40 (1.575)	18 (0.709)	2	15	2.4	14	120
FPG66R0155J--	1.5	Plastic Case M6/6	52 (2.047)	5 (0.197)	55 (2.165)	18(0.709)	4.6	20	1.6	10.5	160
FPG86R0205J--	2	Plastic Case M8/8	52 (2.047)	5 (0.197)	60 (2.362)	22 (0.866)	8	30	1.2	6.1	190
FPG86R0305J--	3	Plastic Case M8/8	52 (2.047)	5 (0.197)	72 (2.835)	22 (0.866)	18	45	0.9	4.5	260
FPG86R0355J--	3.5	Plastic Case M8/8	52 (2.047)	5 (0.197)	72 (2.835)	22 (0.866)	25	50	0.85	4.5	260
FPG86R0405J--	4	Plastic Case M8/8	52 (2.047)	5 (0.197)	82 (1.575)	22 (0.866)	32	60	0.75	3.5	320
FPG86R0505J--	5	Plastic Case M8/8	52 (2.047)	5 (0.197)	82 (3.622)	22 (0.866)	50	70	0.65	2.5	320
FPG86R0605J--	6	Plastic Case M8/8	52 (2.047)	5 (0.197)	92 (3.622)	22 (0.866)	73	75	0.6	2.5	400
FPG 2000V V_{ndc} = 1000V V_{peak} = 1600V V_{rms} = 600V V_s = 2000V (Voltage Code N)											
FPG66N0504J--	0.5	Plastic Case M6/6	52 (2.047)	5 (0.197)	40 (1.575)	18 (0.709)	1	15	3	14	120
FPG86N0105J--	1	Plastic Case M8/8	52 (2.047)	5 (0.197)	60 (2.362)	22 (0.866)	3	20	2.3	10.5	190
FPG86N0155J--	1.5	Plastic Case M8/8	52 (2.047)	5 (0.197)	60 (2.362)	22 (0.866)	7	30	1.5	6.1	190
FPG86N0205J--	2	Plastic Case M8/8	52 (2.047)	5 (0.197)	72 (2.835)	22 (0.866)	12.7	40	1.1	4.5	260
FPG86N0255J--	2.5	Plastic Case M8/8	52 (2.047)	5 (0.197)	72 (2.835)	22 (0.866)	20	60	0.89	3.7	260
FPG86N0305J--	3	Plastic Case M8/8	52 (2.047)	5 (0.197)	82 (3.228)	22 (0.866)	28	60	0.85	3.2	320
FPG86N0355J--	3.5	Plastic Case M8/8	52 (2.047)	5 (0.197)	82 (3.228)	22 (0.866)	39	65	0.78	2.9	320
FPG86N0405J--	4	Plastic Case M8/8	52 (2.047)	5 (0.197)	92 (3.622)	22 (0.866)	50	70	0.7	2.5	400
FPG 2500V V_{ndc} = 1300V V_{peak} = 2000V V_{rms} = 700V V_s = 2500V (Voltage Code P)											
FPG66P0474J--	0.47	Plastic Case M6/6	62 (2.441)	5 (0.197)	40 (1.575)	18 (0.709)	0.7	15	6	25	160
FPG66P0105J--	1	Plastic Case M6/6	62 (2.441)	5 (0.197)	55 (2.165)	18 (0.709)	2	18	3	13	180
FPG66P0155J--	1.5	Plastic Case M6/6	62 (2.441)	5 (0.197)	60 (2.362)	22 (0.866)	4.5	25	2	10	220
FPG86P0205J--	2	Plastic Case M8/8	62 (2.441)	5 (0.197)	72 (2.835)	22 (0.866)	8	35	1.5	6.5	310
FPG86P0255J--	2.5	Plastic Case M8/8	62 (2.441)	5 (0.197)	72 (2.835)	22 (0.866)	12.5	40	1.3	4.8	310
FPG86P0305J--	3	Plastic Case M8/8	62 (2.441)	5 (0.197)	82 (3.228)	22 (0.866)	18	50	1.15	4.4	410
FPG86P0405J--	4	Plastic Case M8/8	62 (2.441)	5 (0.197)	92 (3.622)	22 (0.866)	32	65	0.95	3.4	475
FPG 2600V V_{ndc} = 1750V V_{peak} = 2000V V_{rms} = 800V V_s = 2600V (Voltage Code W)											
FPG66W0474J--	0.47	Plastic Case M6/6	62 (2.441)	5 (0.197)	40 (1.575)	18 (0.709)	1.4	12	4.04	28	160
FPG66W0105J--	1	Plastic Case M6/6	62 (2.441)	5 (0.197)	55 (2.165)	18 (0.709)	5.7	21	2.17	10.9	180
FPG66W0155J--	1.5	Plastic Case M6/6	62 (2.441)	5 (0.197)	60 (2.362)	18 (0.709)	12.9	31	1.55	7.7	220
FPG86W0205J--	2	Plastic Case M8/8	62 (2.441)	5 (0.197)	72 (2.835)	22 (0.866)	23	41	1.24	6.1	310
FPG86W0255J--	2.5	Plastic Case M8/8	62 (2.441)	5 (0.197)	82 (3.228)	22 (0.866)	36	51	1.05	4.5	410
FPG86W0305J--	3	Plastic Case M8/8	62 (2.441)	5 (0.197)	92 (3.622)	22 (0.866)	50	62	0.92	3.9	475
FPG86W0355J--	3.5	Plastic Case M8/8	62 (2.441)	5 (0.197)	92 (3.622)	22 (0.866)	70	72	0.83	3.4	475
FPG86W0395J--	3.9	Plastic Case M8/8	62 (2.441)	5 (0.197)	92 (3.622)	22 (0.866)	85	80	0.78	3.1	475
FPG 3500V V_{ndc} = 2000V V_{peak} = 2400V V_{rms} = 1000V V_s = 3500V (Voltage Code X)											
FPG66X0334J--	0.33	Plastic Case M6/6	62 (2.441)	5 (0.197)	40 (1.575)	18 (0.709)	2	15	2.5	28	160
FPG66X0504J--	0.5	Plastic Case M6/6	62 (2.441)	5 (0.197)	55 (2.165)	18 (0.709)	5	19	2.5	11.2	180
FPG86X0105J--	1	Plastic Case M8/8	62 (2.441)	5 (0.197)	72 (2.835)	22 (0.866)	15	38	1.4	6.2	310
FPG86X0155J--	1.5	Plastic Case M8/8	62 (2.441)	5 (0.197)	82 (3.228)	22 (0.866)	40	56	1.03	3.9	410
FPG86X0205J--	2	Plastic Case M8/8	62 (2.441)	5 (0.197)	92 (3.622)	22 (0.866)	70	75	0.85	3.1	475
FPG 4500V V_{ndc} = 2500V V_{peak} = 3200V V_{rms} = 1200V V_s = 4500V (Voltage Code Z)											
FPG66Z0224J--	0.22	Plastic Case M6/6	62 (2.441)	5 (0.197)	40 (1.575)	18 (0.709)	1.5	15	3.8	25	160
FPG66Z0474J--	0.47	Plastic Case M6/6	62 (2.441)	5 (0.197)	60 (2.362)	18 (0.709)	7	24	2.16	8.5	220
FPG86Z0684J--	0.68	Plastic Case M8/8	62 (2.441)	5 (0.197)	72 (2.835)	22 (0.866)	14	35	1.59	6.2	310
FPG86Z0105J--	1	Plastic Case M8/8	62 (2.441)	5 (0.197)	82 (3.228)	22 (0.866)	30	52	1.18	4	410
FPG86Z1254J--	1.25	Plastic Case M8/8	62 (2.441)	5 (0.197)	92 (3.622)	22 (0.866)	50	65	1	3.3	475
FPG 4600 V V_{ndc} = 3000 V V_{peak} = 4000 V V_{rms} = 1400 V V_s = 4600 V (Voltage Code Y)											
FPG66Y0124J--	0.12	Plastic Case M6/6	62 (2.441)	5 (0.197)	40 (1.575)	18 (0.709)	0.8	15	6	28	160
FPG66Y0224J--	0.22	Plastic Case M6/6	62 (2.441)	5 (0.197)	60 (2.362)	18 (0.709)	3	20	3.48	11	220
FPG86Y0334J--	0.33	Plastic Case M8/8	62 (2.441)	5 (0.197)	72 (2.835)	22 (0.866)	6.8	25	2.42	7.7	310
FPG86Y0474J--	0.47	Plastic Case M8/8	62 (2.441)	5 (0.197)	82 (3.228)	22 (0.866)	13.8	35	1.79	5.2	410
FPG86Y0604J--	0.60	Plastic Case M8/8	62 (2.441)	5 (0.197)	92 (3.622)	22(0.866)	22	45	1.47	4.2	475



Controlled self-healing film capacitor technology, is ideal for discharge applications. DISFIM capacitors range from 2kV to 75kV and the maximum energy per can is 150kJ. Each capacitor is divided into several million elementary capacitances. The weak points in the dielectric are insulated and the capacitor continues to work without a short circuit or risk of explosion. They are designed to lose less than 5% of their capacitance during their lifetime.

Check for up-to-date CV Tables at <http://www.avx.com/docs/catalogs/filmcaps.pdf>

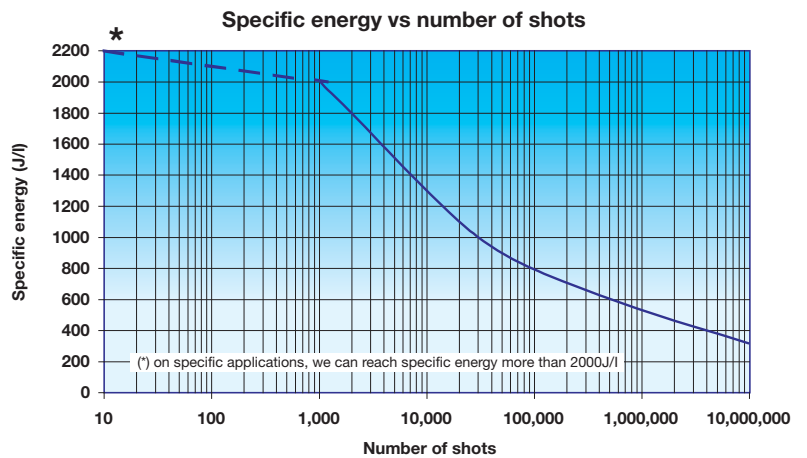
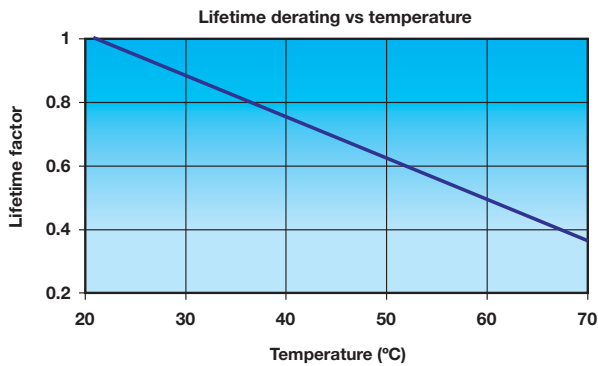
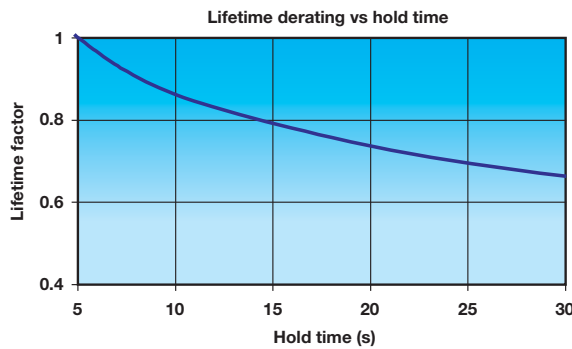
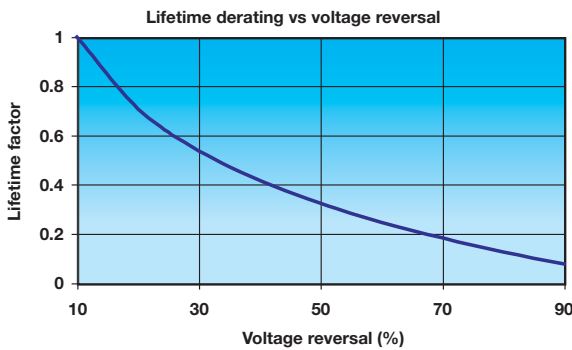
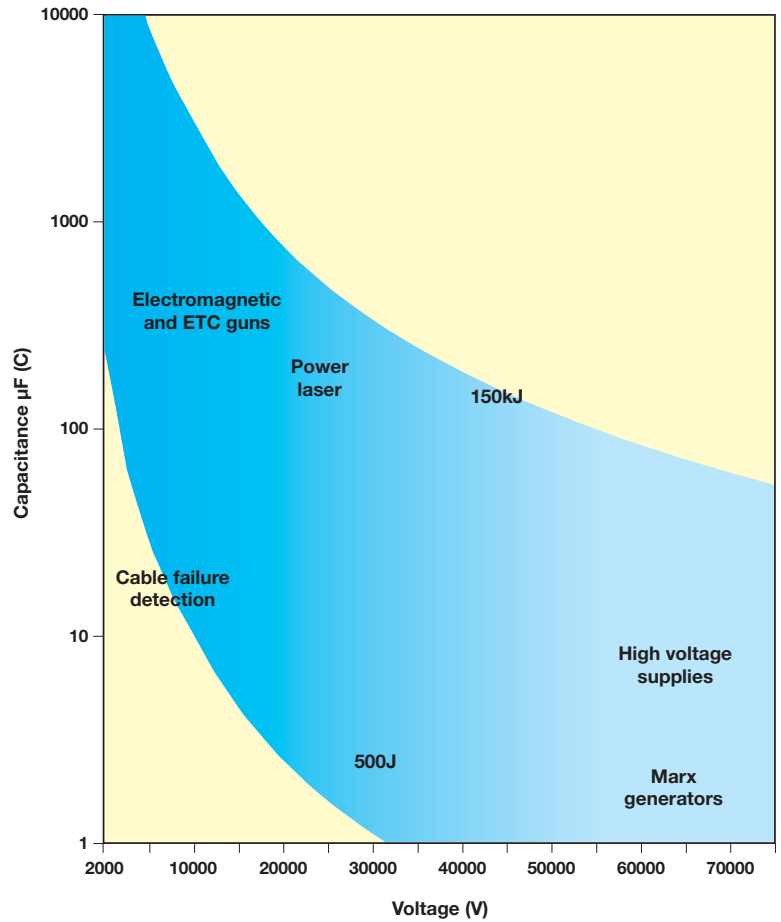

Glass Dielectric Capacitors

MIL-PRF-23269

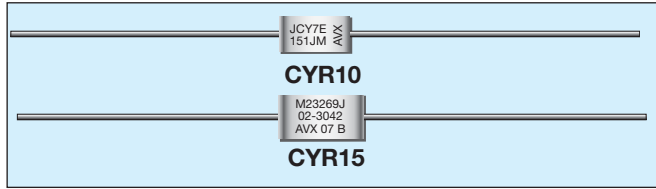

Check for up-to-date CV Tables at <http://www.avx.com/docs/catalogs/glasscaps.pdf>

MARKING

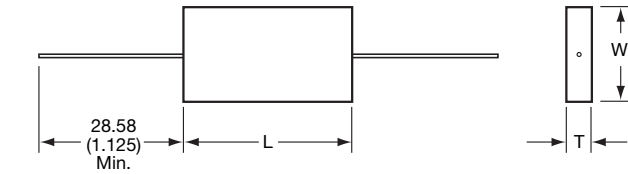

DIMENSIONS:

millimeters (inches)

Case Size	L	W	T	Lead Dia. +0.1(+0.004) -0.03(±0.001)
CYR10	8.74 ± 1.19 (0.344 ± 0.047)	4.37 ± .79 (0.172 ± 0.031)	1.98 ± .79 (0.078 ± 0.031)	.51 (0.020)
CYR15	11.91 ± 1.19 (0.469 ± 0.047)	6.76 ± .79 (0.266 ± 0.031)	2.77 ± 1.19 (0.109 ± 0.047)	.51 (0.020)

Note: Standard leads are solder-coated Dumet.

HOW TO ORDER

M23269

Style
Military Specification
Established Reliability
Glass Capacitor

01

Case Size
01 = CYR10
02 = CYR15

3

Failure Rate
3 = M level 1%/1000 hrs.
7 = S level .001%/1000 hrs.
(100 volt rating only)

001

Capacitance Code
Capacitance value
coded in accordance
with MIL-PRF-23269 –
(see Part Number section)

RATINGS & PART NUMBER REFERENCE

Cap. Value (pF)	Part Number* Capacitance Tolerance		
CYR10 M23269/01-			
500 Volts**	±.25pF	±.5pF	±5%
.5	*.001	-	-
1.0	_.002	-	-
1.5	_.003	-	-
2.2	_.004	*.005	-
2.7	_.006	-	-
3.0	_.007	_.008	-
3.3	_.009	-	-
3.6	_.010	_.011	-
3.9	_.012	-	-
4.3	_.013	_.014	-
4.7	_.015	-	-
5.1	_.016	-	-
5.6	_.017	-	*.018
6.2	_.019	-	_.020
6.8	_.021	-	_.022
7.5	_.023	-	_.024
8.2	_.025	-	_.026
9.1	_.027	-	_.028
10	_.029	-	_.030
11	_.031	-	_.032
12	_.033	-	_.034

* Add first digit to indicate failure rate.
** S LEVEL = 100V rating for all values.

Cap. Value (pF)	Part Number* Capacitance Tolerance		
CYR10 M23269/01- (cont'd.)			
500 Volts**	±1%	±2%	±5%
13	-	*.035	*.036
15	-	_.037	_.038
16	-	_.039	_.040
18	-	_.041	_.042
20	-	_.043	_.044
22	-	_.045	_.046
24	-	_.047	_.048
27	*.049	_.050	_.051
30	_.052	_.053	_.054
33	_.055	_.056	_.057
36	_.058	_.059	_.060
39	_.061	_.062	_.063
43	_.064	_.065	_.066
47	_.067	_.068	_.069
51	_.070	_.071	_.072
56	_.073	_.074	_.075
62	_.076	_.077	_.078
68	_.079	_.080	_.081
75	_.082	_.083	_.084
82	_.085	_.086	_.087
91	_.088	_.089	_.090
100	_.091	_.092	_.093
110	_.094	_.095	_.096
120	_.097	_.098	_.099
130	_.100	_.101	_.102
150	_.103	_.104	_.105
160	_.106	_.107	_.108
180	_.109	_.110	_.111
200	_.112	_.113	_.114

Cap. Value (pF)	Part Number* Capacitance Tolerance		
CYR10 M23269/01- (cont'd.)			
300 Volts**	±1%	±2%	±5%
220	_.115	_.116	_.117
240	_.118	_.119	_.120
270	_.121	_.122	_.123
300	_.124	_.125	_.126
CYR15 M23269/02-			
500 Volts**	±1%	±2%	±5%
220	*.001	*.002	*.003
240	_.004	_.005	_.006
270	_.007	_.008	_.009
300	_.010	_.011	_.012
330	_.013	_.014	_.015
360	_.016	_.017	_.018
390	_.019	_.020	_.021
430	_.022	_.023	_.024
470	_.025	_.026	_.027
510	_.028	_.029	_.030
300 Volts**	±1%	±2%	±5%
560	_.031	_.032	_.033
620	_.034	_.035	_.036
680	_.037	_.038	_.039
750	_.040	_.041	_.042
820	_.043	_.044	_.045
910	_.046	_.047	_.048
1,000	_.049	_.050	_.051
1,100	_.052	_.053	_.054
1,200	_.055	_.056	_.057

Glass Dielectric Capacitors

MIL-PRF-23269

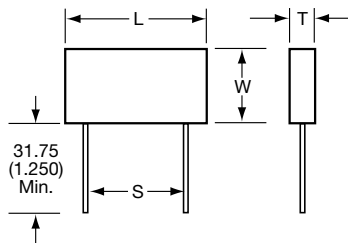
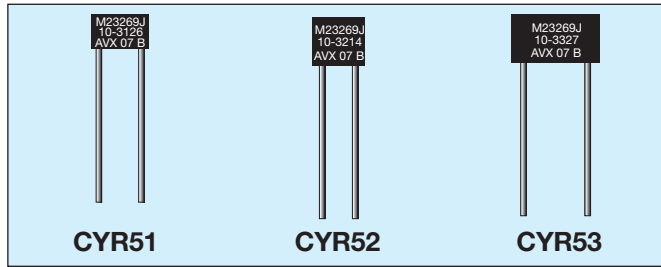

DIMENSIONS: millimeters (inches)

Case Size	L ±0.13 (±0.005)	W ±0.25 (±0.010)	T ±0.13 (±0.005)	S ±0.51 (±0.020)	Lead Dia. ±0.051 (±0.002)
CYR51	7.62 (0.300)	5.08 (0.200)	2.92 (0.115)	5.08 (0.200)	.51 (0.020)
CYR52	7.62 (0.300)	7.62 (0.300)	2.92 (0.115)	5.08 (0.200)	.51 (0.020)
CYR53	12.70 (0.500)	7.62 (0.300)	2.92 (0.115)	10.16 (0.400)	.51 (0.020)

Note: Leads are solderable and weldable gold-plated Dumet, per MIL-STD-1276, Type D.

HOW TO ORDER

M23269

Style

Military Specification
Established Reliability
Glass Capacitor

10

Case Size

Slash sheet
CYR51
CYR52
CYR53

3

Failure Rate

3 = M level, 1%/1000 hrs.

001

Capacitance Code

Capacitance value
coded in accordance
with MIL-C-23269 –
(see Part Number section)

RATINGS & PART NUMBER REFERENCE

Cap. Value (pF)	Part Number Capacitance Tolerance		
CYR51 M23269/10-			
300 Volts	±.25pF	±2%	±5%
1	3001	—	—
1.5	3002	—	—
2.2	3003	—	—
2.7	3004	—	—
3.0	3005	—	—
3.3	3006	—	—
3.6	3007	—	—
3.9	3008	—	—
4.3	3009	—	—
4.7	3010	—	—
5.1	3011	—	3012
5.6	3013	—	3014
6.2	3015	—	3016
6.8	3017	—	3018
7.5	3019	—	3020
8.2	3021	—	3022
9.1	3023	—	3024
10	3025	—	3026
11	3027	—	3028
12	3029	—	3030
13	3031	3032	3033
15	3034	3035	3036
16	3037	3038	3039
18	3040	3041	3042
20	3043	3044	3045
22	3046	3047	3048
24	3049	3050	3051

Cap. Value (pF)	Part Number Capacitance Tolerance		
CYR51 M23269/10- (cont'd)			
300 Volts	±1%	±2%	±5%
27	3052	3053	3054
30	3055	3056	3057
33	3058	3059	3060
36	3061	3062	3063
39	3064	3065	3066
43	3067	3068	3069
47	3070	3071	3072
51	3073	3074	3075
56	3076	3077	3078
62	3079	3080	3081
68	3082	3083	3084
75	3085	3086	3087
82	3088	3089	3090
91	3091	3092	3093
100	3094	3095	3096
110	3097	3098	3099
120	3100	3101	3102
130	3103	3104	3105
150	3106	3107	3108
160	3109	3110	3111
180	3112	3113	3114
200	3115	3116	3117
220	3118	3119	3120
240	3121	3122	3123
270	3124	3125	3126
300	3127	3128	3129
330	3130	3131	3132
360	3133	3134	3135
390	3136	3137	3138
430	3139	3140	3141
470	3142	3143	3144
510	3145	3146	3147
560	3148	3149	3150

Cap. Value (pF)	Part Number Capacitance Tolerance		
CYR52 M23269/10-			
300 Volts	±1%	±2%	±5%
620	3201	3202	3203
680	3204	3205	3206
750	3207	3208	3209
820	3210	3211	3212
910	3213	3214	3215
1,000	3216	3217	3218

CYR53 M23269/10-			
Cap. Value (pF)	Capacitance Tolerance	Capacitance Tolerance	Capacitance Tolerance
1,100	3301	3302	3303
1,200	3304	3305	3306
1,300	3307	3308	3309
1,500	3310	3311	3312
1,600	3313	3314	3315
1,800	3316	3317	3318
2,000	3319	3320	3321
2,200	3322	3323	3324
2,400	3325	3326	3327

*Add first digit to indicate failure rate.



Check for up-to-date CV Tables at
<http://www.avx.com/docs/catalogs/glasscaps.pdf>

MARKING

CYR51, 52, 53

M23269J
10-3001
AVX 07 B

M23269 = Military specification established reliability glass capacitor
J = JAN Trademark
10 = Slash sheet for case sizes – CYR51, CYR52, CYR53
3 = Failure rate (M level)
001 = Capacitance value coded in accordance with MIL-C-23269
AVX = AVX Corporation
07 = Year
B = Lot Code

CROSS REFERENCE

MIL-C-23269 Style	MIL-C-11272 Style
CYR10	CY10
CYR15	CY15
CYR20	CY20
CYR30	CY30
CYR51	CY06
CYR52	CY07
CYR53	CY08

MIL-C-55074

Hermaphrocon™ Connecting System



FEATURES:

- Designed for mobile, transportable, and semi-permanent military communications facilities (telephone, telegraph, teletype, radio, etc.)
- High-reliability Hermaphrocon™ connectors are designed for speedy, foolproof interconnections under extreme field conditions, are impossible to mismatch, even in the dark
- Hermaphrocon™ plugs mate interchangeably with both receptacles and plugs, permitting

connection of either cable end to any other cable end of distribution box

- Redundant Hermaphrocon™ design provides 104 contacts for 52 cable conductors (52 pairs) assures circuit continuity with up to 50% contact damage (jumpers linking redundant contact pairs are welded for reliability)
- Rugged, waterproof Hermaphrocon™ connectors resist wear and damage caused by dragging on the ground or through water, even without covers

SPECIFICATIONS:

- PLUG, ELECTRICAL U-185B/G CONNECTOR
- RECEPTACLE, ELECTRICAL U-186C/G CONNECTOR
- RECEPTACLE, ELECTRICAL U-187A/G CONNECTOR
- CONTACT ASSEMBLY, ELECTRICAL MX-3227/G (as applicable)
- HOUSINGS: Die-cast aluminum alloy with protective finish per MIL-F-14072
- GASKETS AND GLANDS: Silicone rubber
- INSULATORS: Fortron-PPS-Black
- INSULATION RESISTANCE: 1000 megohms, minimum
- CONTACTS:

Beryllium copper, gold plated

- CONTACT RESISTANCE: 7 milliohms, maximum
- IMMERSION: per MIL-C-55074
- MOISTURE RESISTANCE: per MIL-C-55074
- AIR LEAKAGE: per MIL-C-55074
- VIBRATION: per MIL-C-55074
- TEMPERATURE: -65°F to 150°F
- OVERALL DIMENSIONS (approx.):
U-185B/G 2.437" x 2.750" x 13.125"
U-186C/G 3.500" x 4.000" x 6.375"
U-187A/G 2.375" x 3.125" x 6.375"
- MILITARY SPECIFICATION: MIL-C-55074, MIL-STD-454

Plug (Cable Connector)



U-185B/G

Receptacle



U-186C/G

Bottom Mount

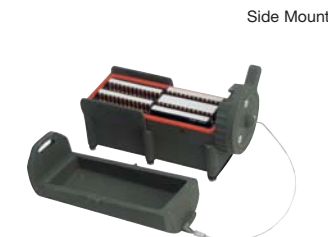

Side Mount

U-187A/G

Contact Assembly

MX-3227/G



Binding Post

SC-C-136011



ELCO P/N 08 2264 0130 00 000
MATERIAL: Brass, machined (terminal)
Nylon (housing)

Check for up-to-date CV Tables at
<http://www.avx.com/docs/catalogs/conns.pdf>

PART	ELCO PART NUMBER	MILITARY PART NUMBER	DESCRIPTION
ELCO HERMAPHROCON™ CONNECTORS	08 2260 0110 00 000	U-185B/G M-55074/1-01	HERMAPHROCON™ PLUG, cable type
	08 2276 0110 00 000	U-186C/G M-55074/2-01	HERMAPHROCON™ RECEPTACLE, panel type
	08 2263 0110 00 000	U-187A/G M-55074/3-01	HERMAPHROCON™ RECEPTACLE, panel type
	08 2260 9010 00 000	MX-3227/G M-55074/4-01	HERMAPHROCON™ CONTACT ASSEMBLY
BINDING POSTS	08 2264 0110 00 000	SIG. CORPS. DWG. # SC-C-136011	SHORT SPRING BINDING POST ASSEMBLY with O-ring, flat washer, split washer and nut - White
	08 2264 0120 00 000	SIG. CORPS. DWG. # SC-C-136001	SHORT SPRING BINDING POST ASSEMBLY without hardware - White
	08 2264 0130 00 000	SIG. CORPS. DWG. # SC-C-136001	LONG SPRING BINDING POST with O-ring, flat washer, split washer and nut - White
	08 2264 0121 00 000	SIG. CORPS. DWG. # SC-C-136001	LONG SPRING BINDING POST without hardware - White

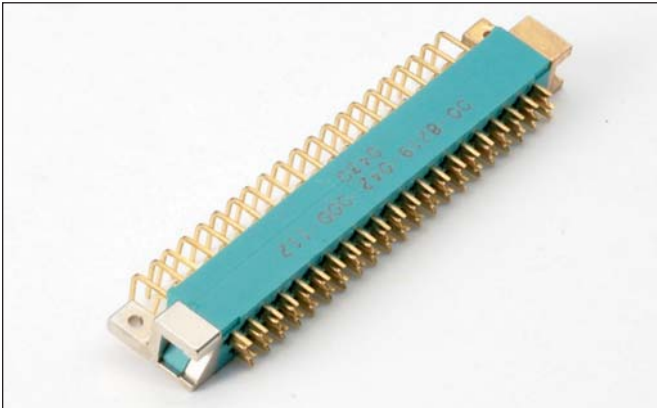

FEATURES

- For p.c. card-to-card applications
- High contact density
- Low withdrawal force contacts
- Rugged, color coded end guides
- Parallel or perpendicular p.c. board mounting
- Mates with Series 8218

Check for up-to-date CV Tables at <http://www.avx.com/docs/catalogs/conns.pdf>

TECHNICAL SPECIFICATIONS

Current Rating:
5 amperes, maximum

Contact Resistance:
6 milliohms, maximum

Contact Material and Plating:
Phosphor Bronze

Gold, 10 microinches minimum,
over nickel, 50 to 100 microinches

Insulator Material:
Diallyl phthalate, glass-filled, flame resistant per MIL-M-14F, Type SDGF.

Guidance Hardware:
Left hand guides: Metal, gold color
Right hand guides: Metal, silver color

Insulation Resistance:
5,000 megohms, minimum

Dielectric Withstanding Voltage:
Sea Level: 1000 Volts rms
3.4" Hg: 500 Volts rms

Insertion/Withdrawal Force:
2 to 8 ounces per contact

ORDERING CODE

00

8219

042

722

001

Number of Contacts
018, 030, 036, 042, 054, 072

Contact Code
(see below)

Variation Code

For Variation = 001			For Variation = 002		
Code No.	Contact Type	"X" Dim.	Code No.	Contact Type	
722	Wire hole tail	.187	000	P. C. solder tails formed	
721	P. C. solder tail	.250	722	Wire hole tail unformed	
736	P. C. solder tail	.281	For Variation = 005		
737	P. C. solder tail	.562			
753	P. C. solder tail	.125			
771	P. C. solder tail	.484			
Code No.	Contact Type	"Y" Dim.	722	Wire hole tail	.157
721	P. C. solder tail	.219	721	P. C. solder tail	.219
736	P. C. solder tail	.250	736	P. C. solder tail	.250
737	P. C. solder tail	.531	737	P. C. solder tail	.531
753	P. C. solder tail	.093	753	P. C. solder tail	.093
771	P. C. solder tail	.453	771	P. C. solder tail	.453

Without Keying	001 = Receptacle
	002 = Plug, parallel board mounting
	005 = Plug, perpendicular board mounting

NOTE: Connector is supplied with mounting screws or eyelets, as applicable (see drawings).

Contact Factory for Special Variations.

POLARIZING SYSTEM

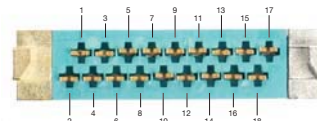

When Keying is ordered with part number, the Key is installed at the factory.

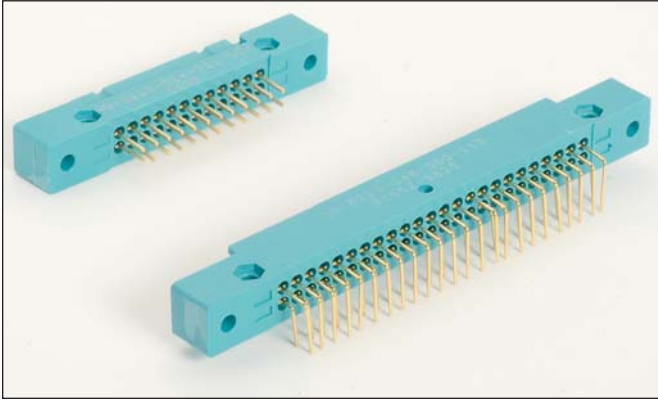

FEATURES

- Wide range of contact terminations including wire wrapping, P.C. solder tail, wire hole, wire crimp
- For 1/16", 3/32" P.C. card
- Polarity and keying are built into the connector body to prevent mismatching
- Perpendicular or parallel connector mounting
- Proven Varicon® contact reliability
- Protected male; recessed female contacts

Check for up-to-date CV Tables at <http://www.avx.com/docs/catalogs/conns.pdf>

TECHNICAL SPECIFICATIONS CONTACTS

Current Rating: 5 amperes with 22 AWG wire
Contact Resistance: 6 milliohms, maximum
Contact Material and Plating: Phosphor Bronze
 Nickel plate, 50 to 100 micro-inches, followed by gold plate.
 10 microinches minimum

INSULATORS

Material: Diallyl Phthalate, glass-filled, flame resistant, per MIL-M-14-F, Type SDGF
Dielectric Withstanding Voltage: Sea Level: 1,000 Volts rms
Insulation Resistance: 5,000 megohms, minimum
Insertion/Withdrawal Force: 2 to 8 ounces per contact

ORDERING CODE

00

8223

024

000

001

Number of Contacts
024, 048, 072 & 096

Contact Code

Variation Code

Use three digit code number when contacts are to be factory installed. If contacts are to be supplied loose, or contact tails to be formed, use three zeros (000) in contact code section. Note that the wire crimp tail contacts can only be ordered as separate items by part numbers.

Code	Profile	Description	Part No.	H Dim.	Board Thk.
000		Coined Tail Formed 90° after installing (Max. 0236 Diag.)	60 8223 0223 60 8223 0213	.080	.062
000		Coined Tail Formed 90° after installing (Max. 0236 Diag.)	60 8223 0243 60 8223 0253	.093	
722		Wire Hole Tail (.032 x .050)	60 8200 1613	.162	
721		P.C. Tail .020 Sq.	60 8200 1623	.228	
736		P.C. Tail .020 Sq.	60 8200 1633	.259	
737		P.C. Tail .020 Sq.	60 8200 1643	.541	
753		P.C. Tail .020 Sq.	60 8200 1653	.103	
771		P.C. Tail .020 Sq.	60 8200 1663	.462	
000		Crimp Contact (Reel 3000) 22-30 AWG	60 8216 0323		
000		Crimp Contact (Loose) 22-30 AWG	60 8216 0313		
491		Wrappable/Removable Contact (.025 Sq.)	60 8216 0413	.560	

Insulator Type	Variation	Contact Style	Accessories	Board Thickness
			Guide Pins Sockets (R) Keying	
Male (Exposed Contacts)	001	Formed Contact Terminal	X	.080 2.03 .062 1.57
	002	PC Terminal	X	
		Wire Hole Terminal	X	
		PC Straight Terminal	X	
		Crimp Contact	X	
003	Wrappable Removable	X		
Female (Exposed Contacts)	004	Formed Contact Terminal	X	.093 2.36
	901	Formed Contact Terminal	X	.080 2.03 .062 1.57
		PC Terminal	X	
		Wire Hole Terminal	X	
		PC Straight Terminal	X	
902	Wrappable Removable	X		
903	Crimp Contact	X		
904	Formed Contact Terminal	X	.093 2.36	

M55302 Two Piece Edge Board Connectors



- M55302 Qualified
- 64 & 96 Pin Male and Female
- Vertical and Right Angle
- Gold Plated Contacts
- Certified to M55302 (500 mating cycles)
- Marked with Military number
- Group A & B testing standard



Check for up-to-date CV Tables at
<http://www.avx.com/docs/catalogs/conns.pdf>

M55302 / XXX - XX

01-09 =
 Contact Style
 Contact Tail Length

- 131 = 96 Pin R/A Male
- 132 = 96 Pin Vert Female
- 133 = 64 Pin R/A Male
- 134 = 64 Pin Vert Female
- 157 = 64 Pin Vert Male
- 148 = 64 Pin R/A Female

PERFORMANCE CLASS AND LOADING VARIATIONS

Class	M55302 & DIN41612 Class I	DIN 41612 Class II	DIN 41612 Class III
Cycle Life	500+ Mating Cycles	400 Mating Cycles	50 Mating Cycles

QUALIFIED MILITARY PART NUMBERS

Military Designation	
M55302/131-01	M55302/134-02
M55302/131-02	M55302/134-04
M55302/132-01	M55302/134-05
M55302/132-02	M55302/134-07
M55302/132-04	M55302/134-08
M55302/132-05	M55302/157-01
M55302/132-06	M55302/157-02
M55302/133-01	M55302/157-03
M55302/133-02	M55302/157-04
M55302/133-03	M55302/158-01
M55302/134-01	M55302/158-02

AMERICAS

AVX Myrtle Beach, SC
Tel: 843-448-9411

AVX Northwest, WA
Tel: 360-699-8746

AVX Midwest, IN
Tel: 317-861-9184

AVX Mid/Pacific, CA
Tel: 408-988-4900

AVX Northeast, MA
Tel: 617-479-0345

AVX Southwest, CA
Tel: 949-859-9509

AVX Canada
Tel: 905-238-3151

AVX South America
Tel: +55-11-4688-1960

EUROPE

AVX Limited, England
Tel: +44-1252-770000

AVX S.A.S., France
Tel: +33-1-69-18-46-00

AVX GmbH, Germany
Tel: +49-8131-9004-0

AVX SRL, Italy
Tel: +39-02-614-571

AVX Czech Republic
Tel: +420-57-57-57-521

AVX/ELCO UK
Tel: +44-1638-675000

ELCO Europe GmbH
Tel: +49-2741-299-0

AVX S.A., Spain
Tel: +34-91-63-97-197

AVX Benelux
Tel: +31-187-489-337

ASIA-PACIFIC

**AVX/Kyocera (S) Pte Ltd.,
Singapore**
Tel: +65-6286-7555

**AVX/Kyocera, Asia, Ltd.,
Hong Kong**
Tel: +852-2363-3303

**AVX/Kyocera Yuhan Hoesa,
South Korea**
Tel: +82-2785-6504

**AVX/Kyocera HK Ltd.,
Taiwan**
Tel: +886-2-2698-8778

**AVX/Kyocera (M) Sdn Bhd,
Malaysia**
Tel: +60-4228-1190

**AVX/Kyocera International
Trading Co. Ltd.,
Shanghai**
Tel: +86-21-6215-5588

**AVX/Kyocera Asia Ltd.,
Shenzen**
Tel: +86-755-3336-0615

**AVX/Kyocera International
Trading Co. Ltd.,
Beijing**
Tel: +86-10-6588-3528

**AVX/Kyocera India
Liaison Office**
Tel: +91-80-6450-0715

ASIA-KED (KYOCERA Electronic Devices)

KED Hong Kong Ltd.
Tel: +852-2305-1080/1223

**KED Hong Kong Ltd.
Shenzen**
Tel: +86-755-3398-9600

**KED Company Ltd.
Shanghai**
Tel: +86-21-6217-1201

**KED Hong Kong Ltd.
Beijing**
Tel: +86-10-5869-4655

KED Taiwan Ltd.
Tel: +886-2-2950-0268

**KED Korea Yuhan Hoesa,
South Korea**
Tel: +82-2-783-3604/6126

**KED (S) Pte Ltd.
Singapore**
Tel: +65-6509-0328

**Kyocera Corporation
Japan**
Tel: +81-75-604-3449

Contact:

