

Fuse Terminal Blocks for Blade-Type Fuses acc. to DIN 72581-3f, ISO 8820-3, Series 2002

<p>0.25 – 2.5 (4) mm² ① AWG 22 – 12 400 V/6 kV/3 I_N 10 A ② Terminal block width 5.2 mm / 0.205 in 10 – 12 mm / 0.43 in</p>	<p>0.25 – 2.5 (4) mm² ① AWG 22 – 12 400 V/6 kV/3 I_N 10 A ② Terminal block width 5.2 mm / 0.205 in 10 – 12 mm / 0.43 in</p>
--	--

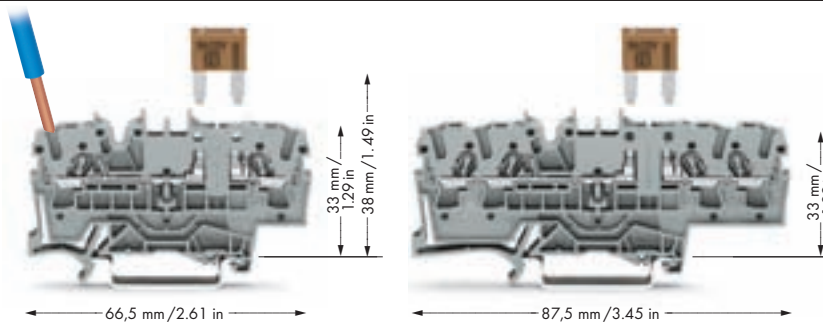

① can be connected: 0.25 mm² – 4 mm² "s+f-st";
can be pushed in directly: 0.75 mm² – 4 mm² "s" and
0.75 mm² – 2.5 mm² "insulated ferrule,
12 mm/0.472 in"

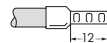

Item no.	Pack. unit	Item no.	Pack. unit
2-conductor fuse terminal blocks		4-conductor fuse terminal blocks	
gray	2002-1681	gray	2002-1881
② - Individual arrangement: 10 A - Block arrangement: 5 A Please note touchproof protection from 42 V		② - Individual arrangement: 10 A - Block arrangement: 5 A Please note touchproof protection from 42 V	

Article-specific accessories

<p>End and intermediate plate, 1 mm/0.039 in thick orange 2002-1692 100 (4 x 25) gray 2002-1691 100 (4 x 25)</p>	<p>End and intermediate plate, 1 mm/0.039 in thick orange 2002-1892 100 (4 x 25) gray 2002-1891 100 (4 x 25)</p>
---	---



Accessories Series 2002

Appropriate marker systems: **WMB/Marker Strips/WMB Inline** (see Full Line Catalog W4, Vol. 1, Sec. 14)

<p>Insulation stop, 5 pcs/strip 200 strips light gray 2002-171 0.25-0.5 mm² dark gray 2002-172 0.75-1 mm²</p>	<p>Protective warning marker, with high voltage symbol, black, for 5 terminal blocks yellow 2002-115 100 (4 x 25)</p>	<p>The rated currents of the fuse cartridges are defined differently in international standards. Due to the different current rating definitions, the recommended current-carrying permanent capacity of the fuses is max. 80% of their rated current according to DIN 72581 part 3 (for an ambient operating temperature of 23 °C). Selecting the correct fuse cartridge is important for product safety within applications as well as the service life/operational reliability of the fuse cartridges. Fuse cartridges can operate perfectly as protection (break-off point) if they are properly selected and are used in accordance with the manufacturers specifications. In general it is necessary to test fuse cartridges under normal conditions and operational failures within your application.</p> <p>With regard to the product safety, it is in general necessary to test the fuse in the appliance under normal conditions and operational failures.</p>
<p>Push-in type jumper bars, light gray, insulated, I_N 25 A 2-way 2002-402 200 (8 x 25) 3-way 2002-403 200 (8 x 25) 4-way 2002-404 200 (8 x 25) 5-way 2002-405 100 (4 x 25) : : 10-way 2002-410 100 (4 x 25)</p>	<p>Staggered jumpers, light gray, insulated, I_N 25 A 2-way 2002-472 100 (4 x 25) 3-way 2002-473 100 (4 x 25) 4-way 2002-474 100 (4 x 25) 5-way 2002-475 50 (2 x 25) : : 12-way 2002-482 50 (2 x 25)</p>	
<p>Push-in type jumper bars, light gray, insulated, I_N 25 A 1 - 3 2002-433 200 (8 x 25) 1 - 4 2002-434 200 (8 x 25) 1 - 5 2002-435 100 (4 x 25) : : 1 - 10 2002-440 100 (4 x 25)</p>	<p>Test plug adapter, for test plug Ø 4 mm/0.157 in 2009-174 100 (4 x 25)</p>	
<p>Modular TOPJOB®S connector, for jumper contact slot 1 pole 2002-511 100 (4 x 25)</p>	<p>Two-way marking adapter, pivotable 2002-121 50 (2 x 25)</p>	
<p>Spacer, modular 2002-549 100 (4 x 25)</p>		
<p>Blade-type fuses acc. to DIN 72581-3f / ISO 8820-3 (not offered by WAGO)</p>	<p>Test plug, with cable 500mm/1'7.7", Ø 2 mm/0.079 in red 210-136 50 (5 x 10)</p>	

Fuse Disconnect Terminal Blocks with Pivotal Fuse Holder, 2.5 (4) mm²/AWG 12, for Miniature Metric Fuses 5 x 20 mm, Series 2002

VOLUME 1

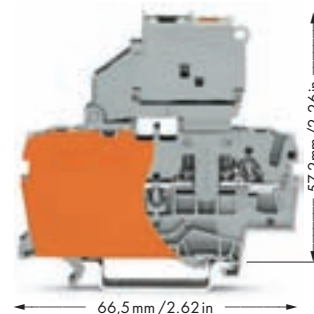
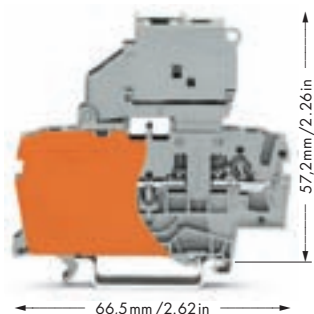

<p>0.25 – 2.5 (4) mm² AWG 22 – 12 250 V/6 kV/3 ① 6.3 A ②</p> <p>Terminal block width 6.2 mm / 0.244 in  10 – 12 mm / 0.43 in</p>	<p>0.25 – 2.5 (4) mm² AWG 22 – 12 250 V/6 kV/3 ① 6.3 A ②</p> <p>Terminal block width 6.2 mm / 0.244 in  10 – 12 mm / 0.43 in</p>
--	--



- ① 800 V = rated voltage
8 kV = rated surge voltage
3 = pollution degree
(see also Full Line Catalog W4, Volume 1, Section 15)
- ② Nominal voltage and current are given by the LED or fuse
- ③ Leakage current in case of blown fuse:
LED 6 mA











Description	Item no.	Pack. unit	Item no.	Pack. unit
Fuse disconnect terminal block with pivotable fuse holder, for DIN 35 rail,	2-conductor fuse terminal block with end plate, without blown fuse indication		2-conductor fuse terminal blocks with end plate, with blown fuse indication by LED	
for miniature metric fuses	5 x 20 mm	gray 2002-1611 50	gray 12 – 30 V ≈ ③ 2002-1611/1000-541 50	
	5 x 20 mm		gray 30 – 65 V ≈ ③ 2002-1611/1000-542 50	
	5 x 20 mm		gray 110 – 250 V ≈ ③ 2002-1611/1000-836 50	



Article-specific accessories

	<p>End plate for fuse terminal blocks, 2 mm/0.079 in thick</p> <p>gray 2002-991 100 (4x25)</p> <p>orange 2002-992 100 (4x25)</p> 	<p>End plate for fuse terminal blocks, 2 mm/0.079 in thick</p> <p>gray 2002-991 100 (4x25)</p> <p>orange 2002-992 100 (4x25)</p> 
--	---	---

Accessories

Appropriate marker systems: **WMB/Marker Strips/WMB Inline** (see Full Line Catalog W4, Volume 1, Section 14)

	<p>Insulation stop, 5 pcs/strip 200 strips</p> <p>light gray 2002-171 0.25-0.5 mm²</p> <p>dark gray 2002-172 0.75-1 mm²</p> <p>must be singularized</p> 	<p>Insulation stop, 5 pcs/strip 200 strips</p> <p>light gray 2002-171 0.25-0.5 mm²</p> <p>dark gray 2002-172 0.75-1 mm²</p> <p>must be singularized</p> 
	<p>Protective warning marker, with high voltage symbol, black, for 5 terminal blocks</p> <p>yellow 2002-115 100 (4 x 25)</p> <p>must be singularized</p> 	<p>Protective warning marker, with high voltage symbol, black, for 5 terminal blocks</p> <p>yellow 2002-115 100 (4 x 25)</p> <p>must be singularized</p> 
	<p>Push-in type jumper bars, light gray, insulated, I_N 25 A</p> <p>2-way 2004-402 200 (8 x 25)</p> <p>3-way 2004-403 200 (8 x 25)</p> <p>4-way 2004-404 200 (8 x 25)</p> <p>5-way 2004-405 100 (4 x 25)</p> <p>: :</p> <p>10-way 2004-410 100 (4 x 25)</p> 	<p>Push-in type jumper bars, light gray, insulated, I_N 25 A</p> <p>2-way 2004-402 200 (8 x 25)</p> <p>3-way 2004-403 200 (8 x 25)</p> <p>4-way 2004-404 200 (8 x 25)</p> <p>5-way 2004-405 100 (4 x 25)</p> <p>: :</p> <p>10-way 2004-410 100 (4 x 25)</p> 
	<p>Push-in type jumper bars, light gray, insulated, I_N 25 A</p> <p>1 - 3 2004-433 200 (8 x 25)</p> <p>1 - 4 2004-434 200 (8 x 25)</p> <p>1 - 5 2004-435 100 (4 x 25)</p> <p>: :</p> <p>1 - 10 2004-440 100 (4 x 25)</p> 	<p>Push-in type jumper bars, light gray, insulated, I_N 25 A</p> <p>1 - 3 2004-433 200 (8 x 25)</p> <p>1 - 4 2004-434 200 (8 x 25)</p> <p>1 - 5 2004-435 100 (4 x 25)</p> <p>: :</p> <p>1 - 10 2004-440 100 (4 x 25)</p> 
	<p>Test plug, with cable 500 mm/1'7.7", ∅ 2 mm/0.079 in ∅</p> <p>red 210-136 50 (5 x 10)</p> 	<p>Test plug, with cable 500 mm/1'7.7", ∅ 2 mm/0.079 in ∅</p> <p>red 210-136 50 (5 x 10)</p> 

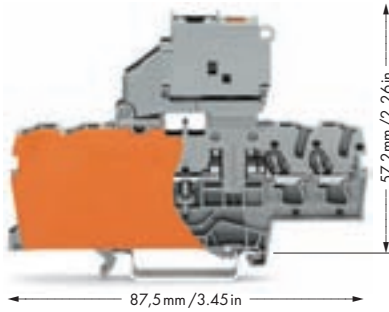
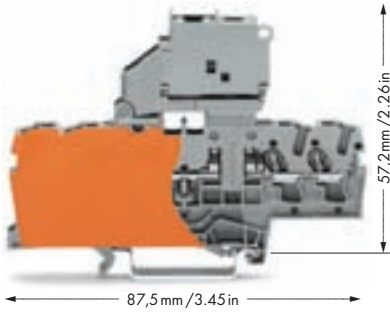

0.25 – 2.5 (4) mm ² 250 V/6 kV/3 ① 6.3 A ② Terminal block width 6.2 mm / 0.244 in  10 – 12 mm / 0.43 in	AWG 22 – 12	0.25 – 2.5 (4) mm ² 250 V/6 kV/3 ① 6.3 A ② Terminal block width 6.2 mm / 0.244 in  10 – 12 mm / 0.43 in	AWG 22 – 12	Application notes













Item no.	Pack. unit	Item no.	Pack. unit
4-conductor fuse terminal block with end plate, without blown fuse indication		4-conductor fuse terminal blocks with end plate, with blown fuse indication by LED	
gray	2002-1811 50	gray 12 – 30 V ≈ ③	2002-1811/1000-541 50
		gray 30 – 65 V ≈ ③	2002-1811/1000-542 50
		gray 110 – 250 V =	2002-1811/1000-836 50



Fuse terminal blocks with a width of 6.2 mm/0.244 in can be assembled adjacent to each other. At the end of an assembly, if there is **no** adjacent fuse or disconnect terminal block, an end plate for fuse terminal blocks must be used.

End plate for fuse terminal blocks, 2 mm/0.079 in thick		End plate for fuse terminal blocks, 2 mm/0.079 in thick	
	gray 2002-991 100 (4x25) orange 2002-992 100 (4x25)		gray 2002-991 100 (4x25) orange 2002-992 100 (4x25)

When selecting miniature metric fuses, the maximum power loss listed below should not be exceeded. The power loss is determined according to IEC or EN 60947-7-3/VDE 0611-6 at 23 °C. The temperature rise of the terminal blocks must be checked according to their application and mounting. Higher ambient temperatures represent an additional impact on miniature metric fuses. Therefore, in such applications the rated current must be reduced if necessary. More details from the manufacturer.

Appropriate marker systems: WMB/Marker Strips/WMB Inline (see Full Line Catalog W4, Volume 1, Section 14)			
	Insulation stop , 5 pcs/strip 200 strips light gray 2002-171 0.25-0.5 mm ² dark gray 2002-172 0.75-1 mm ² must be singularized		Insulation stop , 5 pcs/strip 200 strips light gray 2002-171 0.25-0.5 mm ² dark gray 2002-172 0.75-1 mm ² must be singularized
	Protective warning marker , with high voltage symbol, black, for 5 terminal blocks yellow 2002-115 100 (4 x 25) must be singularized		Protective warning marker , with high voltage symbol, black, for 5 terminal blocks yellow 2002-115 100 (4 x 25) must be singularized
	Push-in type jumper bars , light gray, insulated, I _N 25 A 2-way 2004-402 200 (8 x 25) 3-way 2004-403 200 (8 x 25) 4-way 2004-404 200 (8 x 25) 5-way 2004-405 100 (4 x 25) : : 10-way 2004-410 100 (4 x 25)		Push-in type jumper bars , light gray, insulated, I _N 25 A 2-way 2004-402 200 (8 x 25) 3-way 2004-403 200 (8 x 25) 4-way 2004-404 200 (8 x 25) 5-way 2004-405 100 (4 x 25) : : 10-way 2004-410 100 (4 x 25)
	Push-in type jumper bars , light gray, insulated, I _N 25 A 1 - 3 2004-433 200 (8 x 25) 1 - 4 2004-434 200 (8 x 25) 1 - 5 2004-435 100 (4 x 25) : : 1 - 10 2004-440 100 (4 x 25)		Push-in type jumper bars , light gray, insulated, I _N 25 A 1 - 3 2004-433 200 (8 x 25) 1 - 4 2004-434 200 (8 x 25) 1 - 5 2004-435 100 (4 x 25) : : 1 - 10 2004-440 100 (4 x 25)
	Test plug , with cable 500 mm/1'7.7", Ø 2 mm/0.079 in Ø red 210-136 50 (5 x 10)		Test plug , with cable 500 mm/1'7.7", Ø 2 mm/0.079 in Ø red 210-136 50 (5 x 10)

Miniature metric fuses 5 x 20

Series Item No.	Overload and short circuit protection		Short circuit protection only	
	Individual arrangement	Group arrangement	Individual arrangement	Group arrangement
Fuse terminal blocks				
2002-1611	1.6 W	1.6 W	2.5 W	2.5 W
2002-1811				
2002-1811/.....	1.6 W	1.6 W	2.5 W	2.5 W
2002-1611/.....				

Protective warning marker and insulation stop must be singularized. Due to the 6.2 mm/0.244 in width of the fuse terminal blocks with pivotable fuse holder, 2004 Series jumpers must be used.

	250 V max.* 6.3 max.	* Electrical ratings are given by the fuse or nominal voltage of the indicator lamp respectively.
--	-------------------------	---

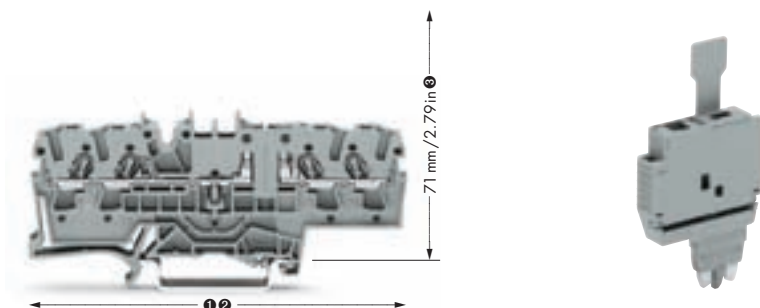

Open side of terminal block	Description	Item no.	Pack. unit
	Fuse plug, for miniature metric fuses 5 x 20 mm	6.1 mm/0.24 in width with pull-tab 2004-0911	50
	Fuse plug, same as above, with additional indicator lamp, LED, AC/DC 12 – 30 V, LED, AC/DC 30 – 65 V, can be used in both switching directions	6.1 mm/0.24 in width with pull-tab 2004-0911/1000-0541 2004-0911/1000-0542	50 50
	AC/DC 120 V – 230 V	6.1 mm/0.24 in width with pull-tab 2004-0911/1000-0836	50

The use of pluggable fuse holders with rail mounted terminal blocks for protection of control circuits offers many advantages to the user since the function and the wiring are accomplished by two separate parts:

- no additional cost for assembly and wiring
- no risk of accidental contact with live parts during disconnection of fuse plug
- in case of exchanging a defective fuse the fuse plug is completely separated from the carrier terminal block
- therefore safe exchange of the fuse away from current carrying parts
- the fuse plug can be taken away by the serviceman avoiding unintentional reclosing of the circuit by another person
- quick exchange of a fuse by using a prepared "stand-by plug."

Further advantages:

- optional LED indicates blown fuse
- marking facility on the fuse plug for clear coordination to the correct carrier terminal block (WSB-Quick Marking System 4 mm/0.157 in)
- two touchproof test slots
- high density with only 6,1 mm/0.24 in width of terminal block/fuse plug
- instead of a fuse, a shorting link may be used as a disconnect plug.

When corresponding Neutral-circuit is adjacent to a fuse plug, a 5.2 mm/0.205 in wide space saving terminal block may be used, as a 6.1 mm/0.24 in fuse plug may overlap the terminal block.

See diagram below.

Miniature metric fuses 5 x 20

Series Item No.	Overload and short circuit protection		Short circuit protection only	
	Individual arrangement	Group arrangement	Individual arrangement	Group arrangement
Fuse terminal blocks				
2004-0911				
2004-0911/.....	1.6 W	1.6 W	2.5 W	2.5 W

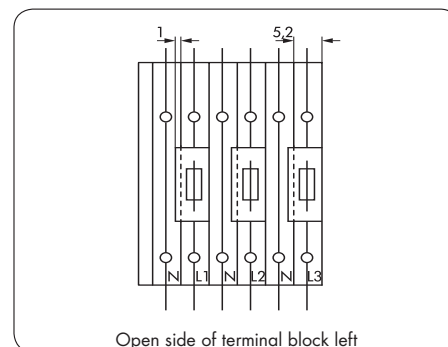

Open side of terminal block left

Terminal blocks and accessories			
Appropriate marker systems: Terminal block WMB/Marker Strips			
	2-conductor carrier terminal block ① , 0.25–2.5 (4) mm ² /AWG 22–12 Stripped length 9–10 mm/0.37 in	Terminal block width 5.2 mm/0.205 in gray 2002-1661	50
	End and intermediate plate, for 2-cond. carrier term. block Item No. 2002-1661	1 mm/0.039 thick orange 2002-1692 gray 2002-1691	100 (4 x 25) 100 (4 x 25)
	4-conductor carrier terminal block ② , 0.25–2.5 (4) mm ² /AWG 22–12 Stripped length 10–12 mm/0.43 in	Terminal block width 6 mm/0.236 in gray 2002-1861	50
	End and intermediate plate, for 4-cond. carrier term. block Item No. 2002-1861	1 mm/0.039 thick orange 2002-1892 gray 2002-1891	100 (4 x 25) 100 (4 x 25)
	Shorting link, 5 x 20 mm, 6.3 A, if the fuse plug is used as disconnect plug	281-503	250 (10 x 25)
	End plate for fuse plug	2 mm/0.079 thick orange 2002-0991 gray 2002-0992	100 (4 x 25) 100 (4 x 25)

① 66.5 mm/2.62 in (2-conductor)
② 87.5 mm/3.45 in (4-conductor)
③ with inserted fuse plug