

NEW PRODUCTS – OCT 1992 CATALOGUE

251-070 to 251-094

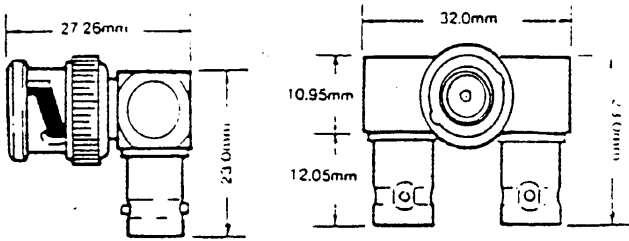

ORDER NO 251070
RIGHT ANGLE PLUG TO (2) JACKS

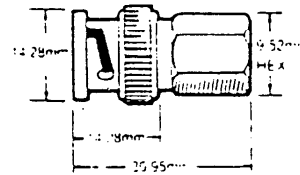

ORDER NO 251100
BNC STRAIGHT PLUG

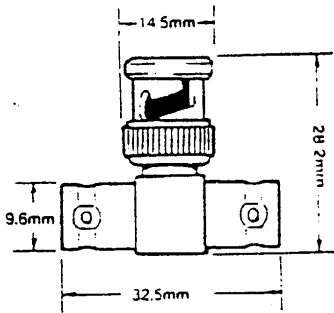

ORDER NO 251197
BNC PLUG TO (2) JACKS

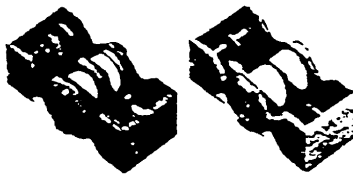

ORDER NO. 251239
3 BLADE CASSETTE

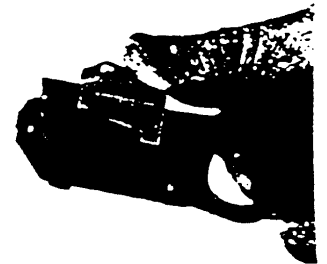

ORDER NO 251215
3 BLADE STRIPPING TOOL

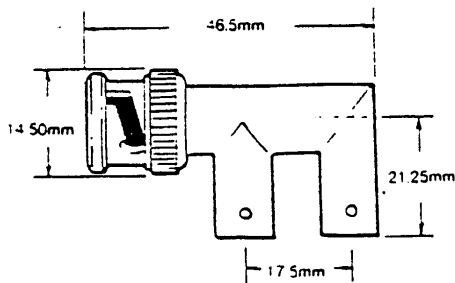

ORDER NO 251082
PLUG TO (2) JACKS - F" STYLE

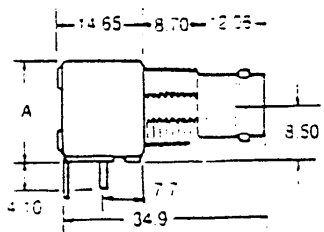

* This dimension is 6.80mm on the low profile version.

ORDER NO 251094
SHIELDED P.C. BOARD MOUNTING
SOCKETS

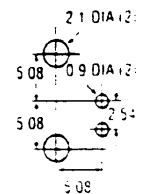
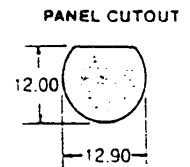

RIGHT ANGLE MOUNTING