

Knob-Type Selector Switch

A165S/W

Mounting Aperture of 16 mm

- 2-piece construction requires no tools
- Oil-resistant IP65 models
- Short mounting depth, less than 28.5 mm below panel
- Wide range of switching capacity from general to microload
- Illuminated and non-illuminated models
- 2 and 3-position models
- Maintained and spring return reset
- UL and CSA approved, VDE pending
- Conforms to EN60947-5-1, IEC947-5-1

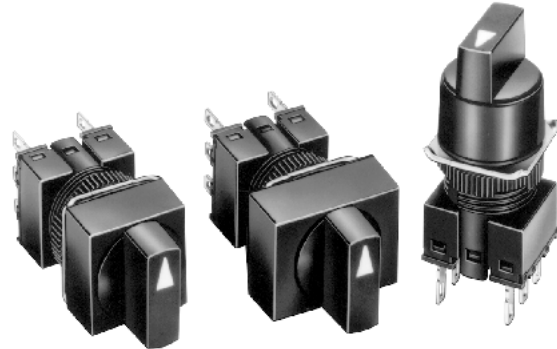

Ordering Information

■ CONSTRUCTION

Flange Shape

Protective Case and Terminal Type

- **Protective Structure**
Oil-resistant IP65
- **Terminal Type**
Solder terminals
(tab terminals #110)

Lamp

- LED

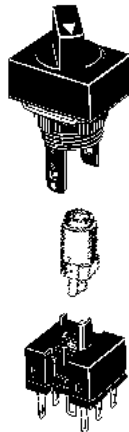

Available Colors

- For LED
Red, green, yellow

Number of Positions and Reset Method

- **2 Positions**
Maintained
Spring return
- **3 Positions**
Maintained
Spring return

Switch Unit Specifications

- **General-purpose Loads**
125 VAC: 5 A
250 VAC: 3 A
30 VDC 3 A
Minimum applicable load: 1 mA at 5 VDC

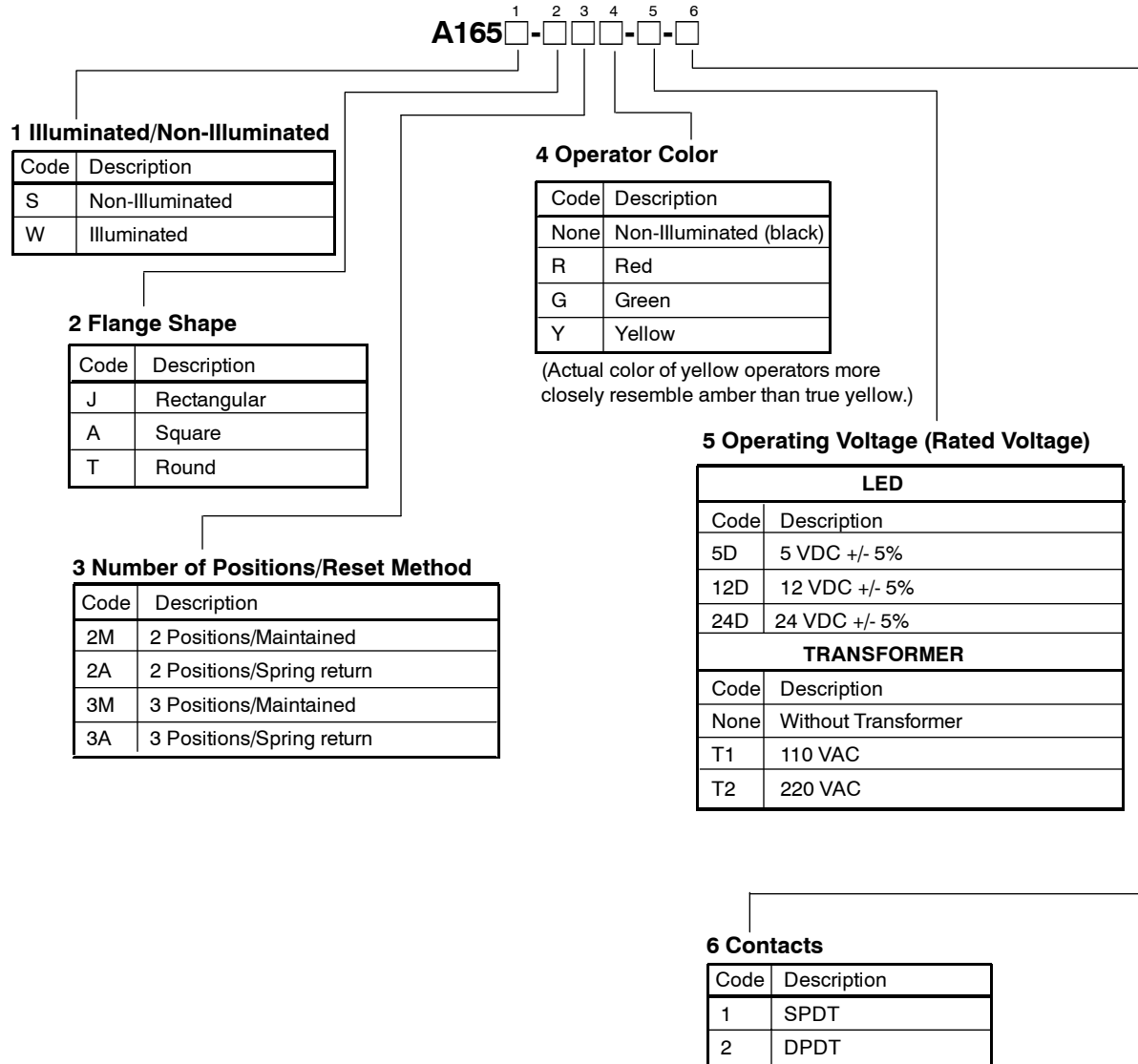

■ PART NUMBER LEGEND A165 SELECTOR SWITCH (COMPLETE ASSEMBLY)

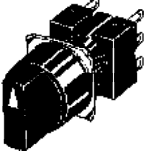
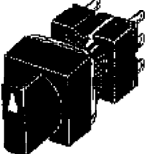
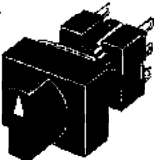

■ PART NUMBERS: A165S ASSEMBLED NON-ILLUMINATED KNOB-TYPE SELECTOR SWITCH
(COMPLETE ASSEMBLY)

Shape	Number of positions	Contact	Reset method	Part number
Round 	2 positions	SPDT	Maintained	A165S-T2M-1
			Spring return (right)	A165S-T2A-1
	3 positions	DPDT	Maintained	A165S-T2M-2
			Spring return (right)	A165S-T2A-2
			Maintained	A165S-T3M-2
			Spring return (both)	A165S-T3A-2
Square 	2 positions	SPDT	Maintained	A165S-A2M-1
			Spring return (right)	A165S-A2A-1
	3 positions	DPDT	Maintained	A165S-A2M-2
			Spring return (right)	A165S-A2A-2
			Maintained	A165S-A3M-2
			Spring return (both)	A165S-A3A-2
Rectangular 	2 positions	SPDT	Maintained	A165S-J2M-1
			Spring return (right)	A165S-J2A-1
	3 positions	DPDT	Maintained	A165S-J2M-2
			Spring return (right)	A165S-J2A-2
			Maintained	A165S-J3M-2
			Spring return (both)	A165S-J3A-2

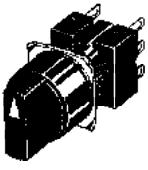
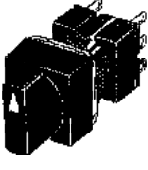
■ A165W ILLUMINATED (2 POSITION) KNOB-TYPE SELECTOR SWITCH (COMPLETE ASSEMBLY)

Description				Part number		
Appearance	Type	Rated voltage	Contacts	Maintained	Spring return from right	
Round 	Full voltage LED (DC)	5 VDC	SPDT	A165W-T2M□-5D-1	A165W-T2A□-5D-1	
		12 VDC		A165W-T2M□-12D-1	A165W-T2A□-12D-1	
		24 VDC		A165W-T2M□-24D-1	A165W-T2A□-24D-1	
	Transformer 24 V Secondary	110 VAC		A165W-T2M□-T1-1	A165W-T2A□-T1-1	
		220 VAC		A165W-T2M□-T2-1	A165W-T2A□-T2-1	
		Full voltage LED (DC)		5 VDC	DPDT	A165W-T2M□-5D-2
	12 VDC		A165W-T2M□-12D-2	A165W-T2A□-12D-2		
	24 VDC		A165W-T2M□-24D-2	A165W-T2A□-24D-2		
	Transformer 24 V Secondary	110 VAC	A165W-T2M□-T1-2	A165W-T2A□-T1-2		
		220 VAC	A165W-T2M□-T2-2	A165W-T2A□-T2-2		
		Square 	Full voltage LED (DC)	5 VDC		SPDT
	12 VDC			A165W-A2M□-12D-1	A165W-A2A□-12D-1	
24 VDC	A165W-A2M□-24D-1			A165W-A2A□-24D-1		
Transformer 24 V Secondary	110 VAC		A165W-A2M□-T1-1	A165W-A2A□-T1-1		
	220 VAC		A165W-A2M□-T2-1	A165W-A2A□-T2-1		
	Full voltage LED (DC)		5 VDC	DPDT	A165W-A2M□-5D-2	
12 VDC			A165W-A2M□-12D-2		A165W-A2A□-12D-2	
24 VDC			A165W-A2M□-24D-2		A165W-A2A□-24D-2	
Transformer 24 V Secondary	110 VAC		A165W-A2M□-T1-2		A165W-A2A□-T1-2	
	220 VAC		A165W-A2M□-T2-2		A165W-A2A□-T2-2	
	Rectangular 		Full voltage LED (DC)		5 VDC	SPDT
12 VDC				A165W-J2M□-12D-1	A165W-J2A□-12D-1	
24 VDC		A165W-J2M□-24D-1		A165W-J2A□-24D-1		
Transformer 24 V Secondary		110 VAC	A165W-J2M□-T1-1	A165W-J2A□-T1-1		
		220 VAC	A165W-J2M□-T2-1	A165W-J2A□-T2-1		
		Full voltage LED (DC)	5 VDC	DPDT	A165W-J2M□-5D-2	
12 VDC			A165W-J2M□-12D-2		A165W-J2A□-12D-2	
24 VDC			A165W-J2M□-24D-2		A165W-J2A□-24D-2	
Transformer 24 V Secondary		110 VAC	A165W-J2M□-T1-2		A165W-J2A□-T1-2	
		220 VAC	A165W-J2M□-T2-2		A165W-J2A□-T2-2	

Note: To complete the part number, replace the □ symbol with the appropriate color code from the *Operator Color Code* table below.

Operator Color Codes

(Actual color of yellow pushbuttons more closely resembles amber than true yellow).

Code	Color
R	Red
Y	Yellow
G	Green

■ A165W ILLUMINATED (3 POSITION) KNOB-TYPE SELECTOR SWITCH (COMPLETE ASSEMBLY)

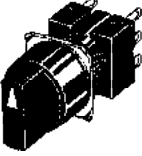
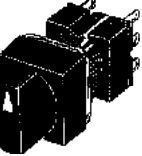
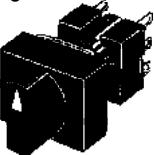
Description				Part number	
Appearance	Type	Rated voltage	Contacts	Maintained	Spring return from both
Round 	Full voltage LED (DC)	5 VDC	DPDT	A165W-T3M□-5D-2	A165W-T3A□-5D-2
		12 VDC		A165W-T3M□-12D-2	A165W-T3A□-12D-2
		24 VDC		A165W-T3M□-24D-2	A165W-T3A□-24D-2
	Transformer 24 V Secondary	110 VAC		A165W-T3M□-T1-2	A165W-T3A□-T1-2
		220 VAC		A165W-T3M□-T2-2	A165W-T3A□-T2-2
Square 	Full voltage LED (DC)	5 VDC	DPDT	A165W-A3M□-5D-2	A165W-A3A□-5D-2
		12 VDC		A165W-A3M□-12D-2	A165W-A3A□-12D-2
		24 VDC		A165W-A3M□-24D-2	A165W-A3A□-24D-2
	Transformer 24 V Secondary	110 VAC		A165W-A3M□-T1-2	A165W-A3A□-T1-2
		220 VAC		A165W-A3M□-T2-2	A165W-A3A□-T2-2
Rectangular 	Full voltage LED (DC)	5 VDC	DPDT	A165W-J3M□-5D-2	A165W-J3A□-5D-2
		12 VDC		A165W-J3M□-12D-2	A165W-J3A□-12D-2
		24 VDC		A165W-J3M□-24D-2	A165W-J3A□-24D-2
	Transformer 24 V Secondary	110 VAC		A165W-J3M□-T1-2	A165W-J3A□-T1-2
		220 VAC		A165W-J3M□-T2-2	A165W-J3A□-T2-2

Note: To complete the part number, replace the □ symbol with the appropriate color code from the Operator *Color Code* table below.

Operator Color Codes

(Actual color of yellow pushbuttons more closely resembles amber than true yellow).



Code	Color
R	Red
Y	Yellow
G	Green

Accessories (Order Separately)

■ PANEL PLUGS

Shape	Classification	Remarks	Part number
	Rectangular	Used for covering the panel cutouts for future panel expansion.	A3BJ-3003
	Square		A3BA-3003
	Round		A3BT-3003

■ TOOLS

Name	Shape	Applicable types					Remarks	Part number
		Pushbutton Switch	Knob-type Selector Switch	Key-type Selector Switch	Emergency Stop Switch	Pilot Light		
Screw fitting		Yes	Yes	Yes	Yes	Yes	Convenient for ganged installation. Tighten to a torque of 0.39 N • m (5 kgf • cm) min.	A3B-3004
Extractor		Yes	Yes	Yes	Yes	Yes	Convenient for extracting the Switch Unit and Lamps.	A16Z-5080

Specifications

■ APPROVED STANDARDS

UL, cUL (File No. E41515)

5 A at 125 VAC, 3 A at 250 VAC (general use)
3 A at 30 VDC (resistive)

EN60947-5-1 (Low Voltage Directive)

■ RATINGS

AC resistive load (AC15)	DC resistive load (DC13)
3 A, 250 VAC 5 A, 125 VAC	3 A, 30 VDC

Minimum applicable load: 1 mA at 5 VDC

Rated values are obtained from tests conducted under the following conditions according to JIS C4505 and C4520.

1. Load: Resistive load
2. Mounting conditions: No vibration and no shock
3. Temperature: 20°±2°C (68F°±3.6F°)
4. Operating frequency: 20 times/min

■ CONTACT

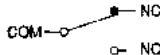
Name	Contact
SPDT	

■ LED

Rated voltage	Rated current	Operating voltage	Internal limiting resistor
5 VDC	30 mA	5 VDC±5%	33 Ω
12 VDC	15 mA	12 VDC±5%	270 Ω
24 VDC	10 mA	24 VDC±5%	1600 Ω

■ CHARACTERISTICS

Item	Knob-type Selector Switch	
Allowable operating frequency (See Note 1.)	Mechanical	20 operations/min max.
	Electrical	10 operations/min max.
Insulation resistance	100 M Ω min. (at 500 VDC)	
Dielectric strength	1,000 VAC, 50/60 Hz for 1 min between terminals of same polarity 2,000 VAC, 50/60 Hz for 1 min between terminals of different polarity and also between each terminal and ground 1,000 VAC, 50/60 Hz for 1 min between lamp terminals (See note 2)	
Vibration resistance	Malfunction	10 to 55 Hz, 1.5-mm double amplitude (malfunction within 1 ms)
Shock resistance	Mechanical	500 m/s ² (50G)
	Malfunction	150 m/s ² (15G) max. (malfunction within 1 ms)
Life expectancy	Mechanical	250,000 operations min.
	Electrical	100,000 operations min.
Ambient temperature	Operating: -10°C to 55°C (14°F to 131°F) with no icing or condensation Storage: -25°C to 65°C (-13°F to 149°F) with no icing or condensation	
Ambient humidity	Operating: 35% to 85%	
Electric shock protection class	Class II	
Degree of contamination	3 (IEC947-5-1)	
Weight	Approx. 13 g (0.46 oz) in the case of a Illuminated DPDT switch	

- Note: 1. Set and reset constitute one operation.
2. With LED and incandescent lamp not mounted.

■ OPERATING CHARACTERISTICS

Features	Knob-type Selector Switch	
	2 Positions	3 Positions
Operating force (OF) max.	0.1 N • m (1,000 gf • cm)	
Set position (SP)	90 \pm 5°	45 \pm 10°

■ OPERATION ANGLE

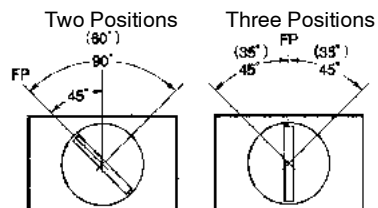

Note: The angle used for automatic reset is shown in parentheses.

■ CONTACTS

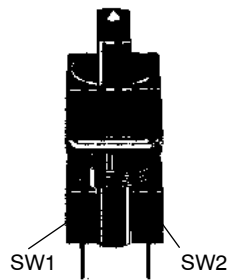

Position	Contact				
	SPDT		DPDT		
	Position	SW	Position	SW1	SW2
2 Positions					
3 Positions	—				
	—				
	—				

Dimensions

Unit: mm (inch)

■ KNOB-TYPE SELECTOR SWITCHES WITHOUT TRANSFORMER

Rectangular A165□-J

Solder terminals

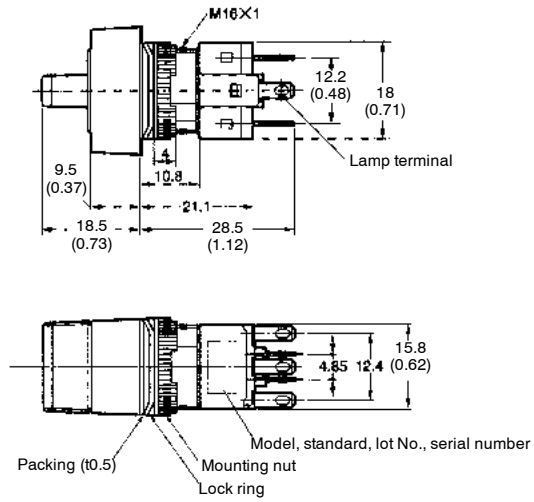
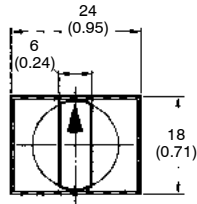
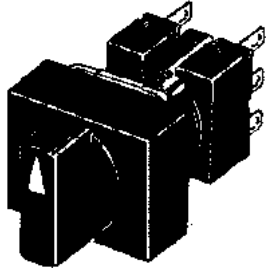

Square A165□-A

Solder terminals

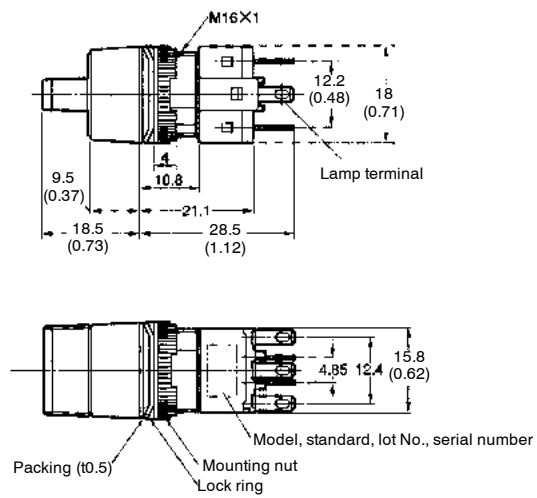
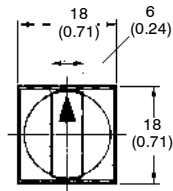
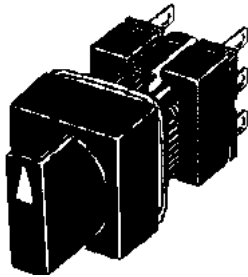

Round A165□-T

Solder terminals

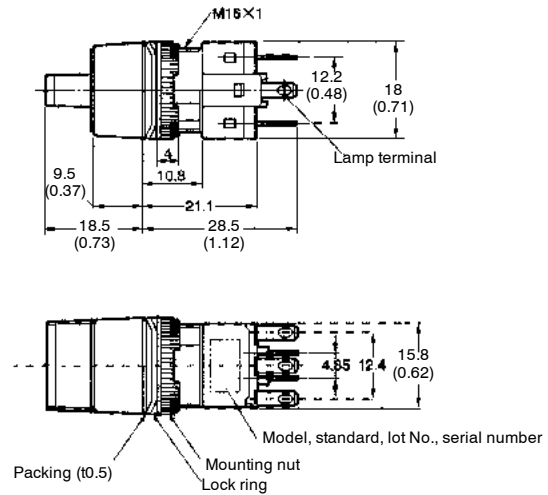
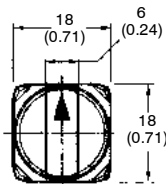
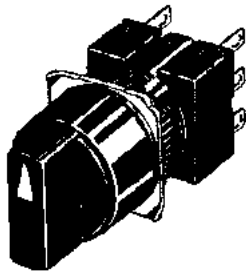

■ PANEL CUTOUTS

Rectangular
A165□-J

(Top View)

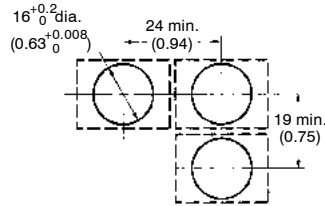

Square A165□-A
Round A165□-T

(Top View)

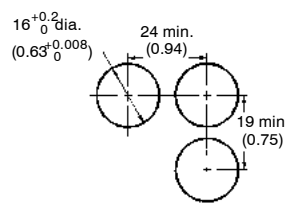

- Note:
1. Make sure the thickness of the mounting panel is between 0.5 and 3.2 mm. If, however, a Switch Guard or Dust Cover is used, the thickness of the mounting panel must be between 0.5 and 2 mm.
 2. If the panel is to be finished with coating, etc., make sure that the panel meets the specified dimensions after coating.

■ TERMINAL ARRANGEMENT

Without Transformer

Lamp terminals are not provided with the Non-illuminated Knob-type Selector Switches and Key-type Selector Switches.

SPDT Switches

Illuminated type

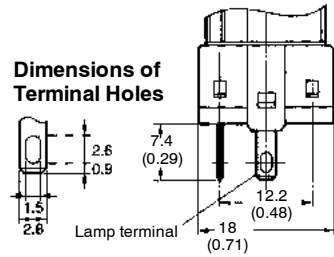

Terminal Arrangement
(Bottom View)

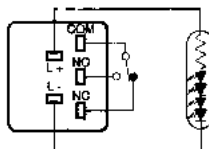

Note: The L+ is not shown on the Switch Unit.

DPDT Switches

Illuminated type

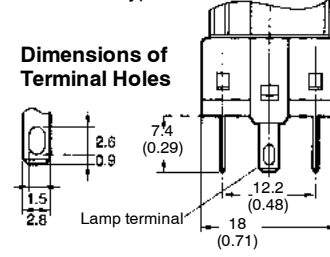

Terminal Arrangement
(Bottom View)

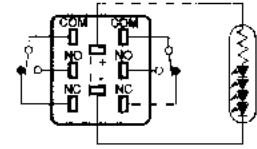

Note: The L+ is not shown on the Switch Unit.

Installation

For details on Panel Mounting, mounting and removing the Switch Unit, refer to installation details for the A16 Pushbutton Switch.

■ FLANGE ROTATION (COMMON TO ALL SELECTOR SWITCHES)

A165 Knob-type Selector Switch

Fix the Switch screw and rotate the flange in 45° turns.

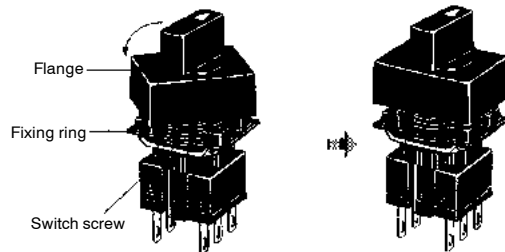

NOTE: DIMENSIONS SHOWN ARE IN MILLIMETERS. To convert millimeters to inches divide by 25.4.

OMRON[®]

OMRON ELECTRONICS LLC

One East Commerce Drive
Schaumburg, IL 60173

1-800-55-OMRON

OMRON ON-LINE

Global - <http://www.omron.com>
USA - <http://www.omron.com/oei>
Canada - <http://www.omron.com/oci>

OMRON CANADA, INC.

885 Milner Avenue
Scarborough, Ontario M1B 5V8

416-286-6465