



**NEW** DIGITAL FIBER SENSOR

FX-100<sub>SERIES</sub>



Welcome to 100

Bringing digital fiber sensors closer

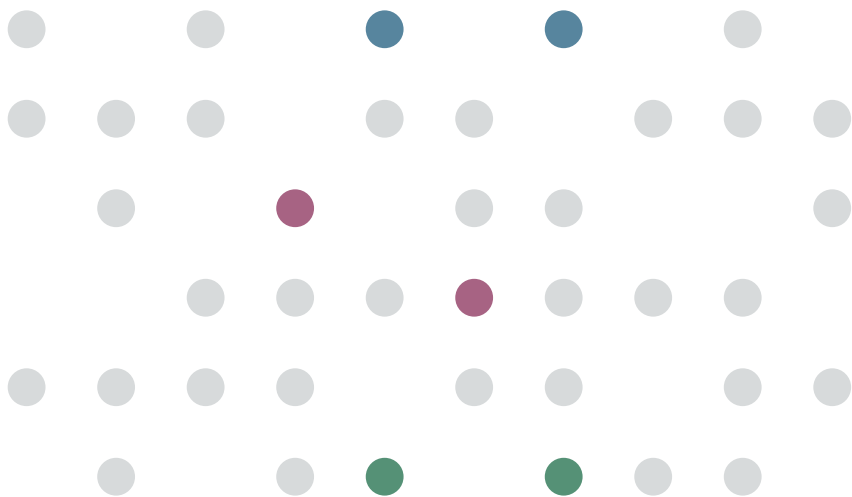

# New possibilities with digital fiber sensors.

## The FX series is a round 100 for success.



Easy to read, multipurpose, and at an economical price.

The FX series has been designed to be what customers want it to be.

Take a step into the new world that starts with '100'.

### Easy to read

#### The digital dual-display shines out in the workplace!

The digital dual-display allows you to check both the threshold value and incident light intensity at the same time, and it also makes the procedures for setting the various values much easier. The threshold values can be adjusted simply by pressing the  (UP) key or the  (DOWN) key, so that the sensors can be used at the same sensitivity levels as analog control-type sensors. And of course a key lock function is also included.



### Multipurpose

#### Commercially-available connectors are used so that lead time and spare part numbers can both be reduced.

The connectors used are commercially-available connectors, so that processing costs and lead time required for carrying out processing after purchase of the sensors can be greatly reduced. The same connection parts as the DP-100 series of digital pressure sensors and the PM-64 series of micro photoelectric sensors can be used.

Commercially-available press-fit connectors are used, so that the processing costs for connection cables can be greatly reduced.

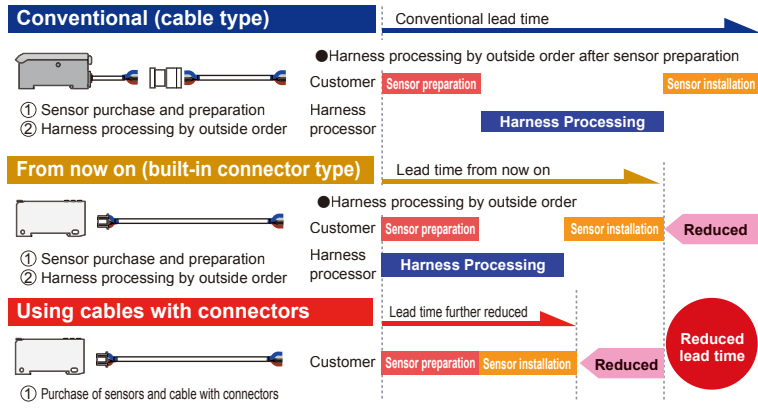

### SUNX fiber sensor product lineup

Select the best types to suit your application.

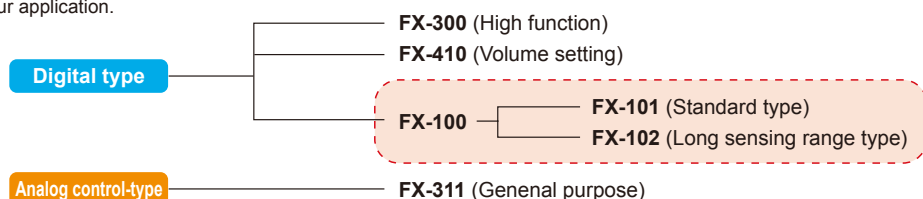



Digital fiber sensor

# FX-100 SERIES

Designed in a 3-layer structure to accommodate basic settings through to advanced settings.

Setting details are divided into three levels for clearer operation, so that settings for normal operation are made in 'RUN mode', basic settings are made in 'SET mode', and advanced functions are set in 'PRO mode'. This makes setting operations much easier to understand and carry out.

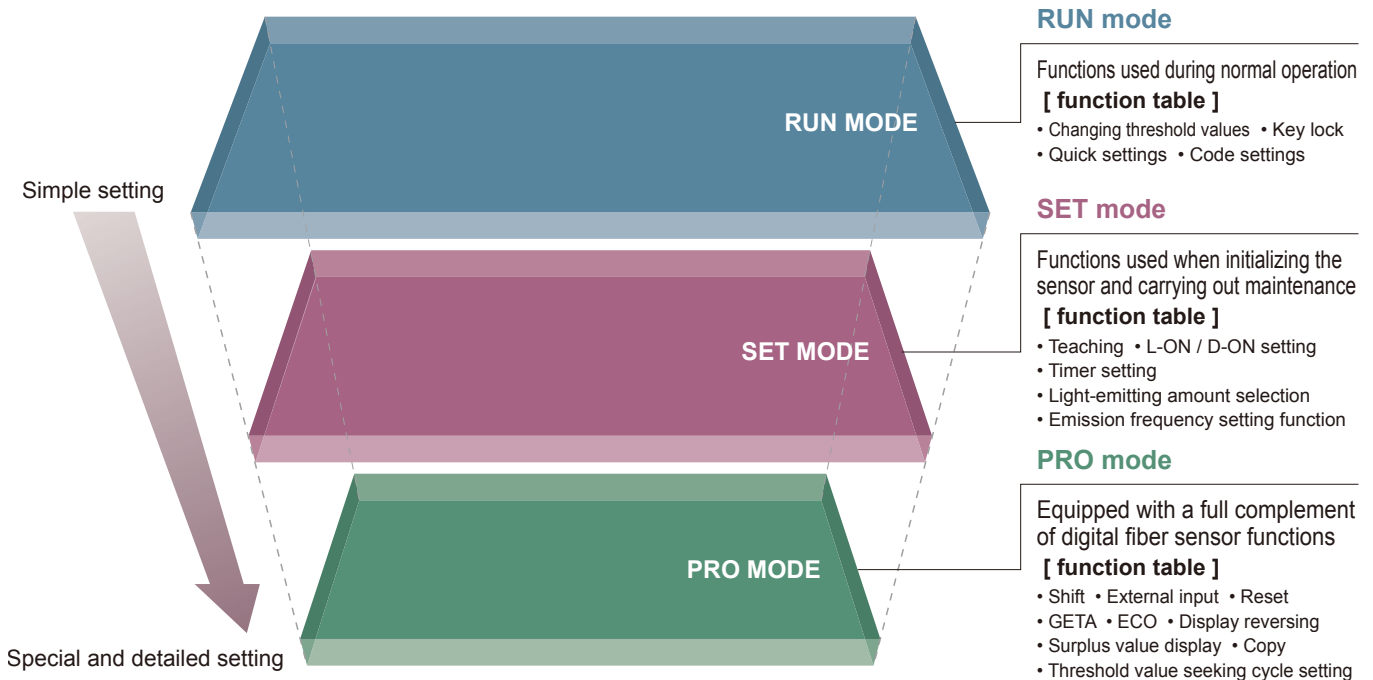

The same operating system is shared by the widely-acclaimed **DP-100** series of digital pressure sensors. The '100' is the indicator for easy handling.



Digital pressure sensor **DP-100** series

Easy for inexperienced operators to use,  
and experienced operators will still be satisfied too.  
Introducing sensors with a full complement of functions  
to support the needs of your workplace.



**R U N M O D E** Changing threshold values Key lock Quick settings Code settings

### Quick code input function

For factory operators For designers

Sensor settings can be made simply by selecting preset values.



### Quick setting numbers (summary)

No.	Output operation	Light-emitting amount selection	Timer
-00-	Dark-ON	OFF	None
-01-	Dark-ON	ON	None
-02-	Dark-ON	OFF	OFF-delay 10 ms
-03-	Dark-ON	ON	OFF-delay 10 ms
-10-	Light-ON	ON	ON-delay 40 ms
-11-	Light-ON	OFF	ON-delay 40 ms
-12-	Light-ON	ON	ON-delay 10 ms
-13-	Light-ON	OFF	ON-delay 10 ms



### Smooth support via telephone

Confirmation can be carried out smoothly via telephone by simply quoting numbers. This can be of great assistance when dealing with overseas customers.

# SET MODE

Teaching

L-ON / D-ON setting

Timer setting

Light-emitting amount selection

Interference prevention function

## Teaching using ON / OFF buttons

For factory operators

Simply press the ON button when an object is present and OFF when it is not. There is no need to switch settings or make judgments between Light-ON (*L\_on*) and Dark-ON (*d\_on*).

### <Setting example>

Thru-beam type

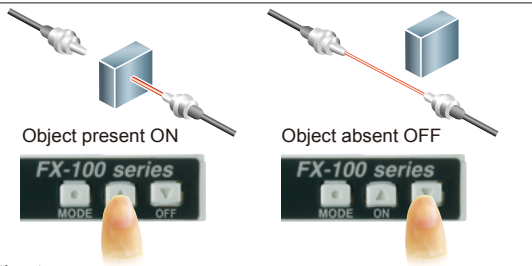

Reflective type

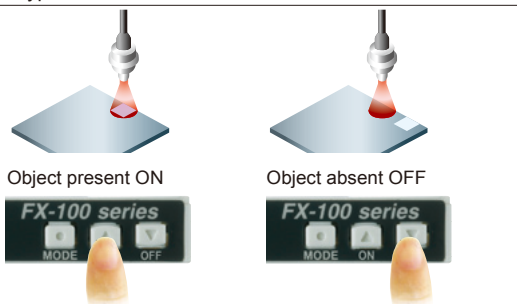

## Limit teaching function

This carries out teaching and sets threshold values only when no object is present (when the incident light amount is stable). This is useful when sensing objects if there are other objects in the background and when sensing minute objects. Teaching can also be carried out using external input.

# PRO MODE

Shift

External input

Threshold value seeking cycle setting

GETA

ECO

Display reversing

Surplus value display

Copy

Reset

## Threshold value seeking cycle setting function

For factory operators

This function seeks changes in the light emitting amount resulting from changes in the environment over long periods (such as dust levels), so that the incident light intensity can be checked at desired intervals and the threshold values can be reset automatically.

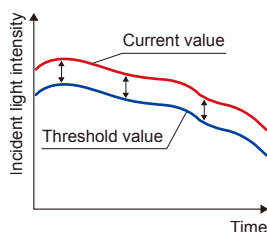

## Light-emitting amount selection function

For designers

If the light receiving level becomes saturated when sensing over short distances or when sensing transparent objects or minute objects, the light emitting amount can be adjusted so that stable sensing can be provided without needing to change the response time.

## Emission frequency setting function

For factory operators

(FX-101□ : Interference prevention for up to 3 units)  
(FX-102□ : Interference prevention for up to 4 units)

The emission frequencies can be set separately for each unit in order to avoid interference. The emitted light flashes while setting is in progress, so that you can see at a glance which fiber sensor is currently being set. In addition, this interference prevention is not done by using optical communication. This means that there is no need to place the amplifiers close together like there was before, and so the amplifiers can be set up apart from each other.

※When the emission frequencies are changed, the response times will also change.



## The functions and performance of a digital fiber sensor at an easily-affordable price!

SUNX digital-type sensors have never been more accessible than this. And they are ideal as replacement products for analog control types and teaching types also.

## External input function

Settings such as emission halt, limit / auto teaching and ECO settings can be carried out via external input.

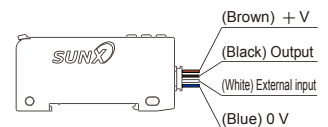

External input lines are equipped as standard

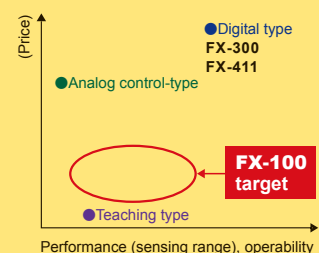

## ORDER GUIDE

### Amplifiers

Type	Appearance	Model No.	Emitting element	Output
Standard type		<b>FX-101</b> (Note 2)	Red LED	NPN open-collector transistor
		<b>FX-101-Z</b> (Note 3)		NPN open-collector transistor
		<b>FX-101P</b> (Note 2)		PNP open-collector transistor
		<b>FX-101P-Z</b> (Note 3)		PNP open-collector transistor
		<b>FX-101-CC2</b>		NPN open-collector transistor
		<b>FX-101P-CC2</b>		PNP open-collector collector transistor
Long sensing range type		<b>FX-102</b> (Note 2)		NPN open-collector transistor
		<b>FX-102-Z</b> (Note 3)		NPN open-collector transistor
		<b>FX-102P</b> (Note 2)		PNP open-collector transistor
		<b>FX-102P-Z</b> (Note 3)		PNP open-collector transistor
		<b>FX-102-CC2</b>		NPN open-collector transistor
		<b>FX-102P-CC2</b>		PNP open-collector transistor

### Accessory

- **CN-14A-C2**  
(Connector attached)  
cable 2 m 6.562 ft  
※Only include cable set type



Notes: 1) The connector attached cable (CN-14A-C2) is supplied with the amplifier.  
 2) Be sure to use the CN-14A-C cable with connector (sold separately).  
 3) Make sure to use the optional M8 connector attached cable CN-24A-C given below.

## OPTIONS

Designation	Model No.	Description	
Connector attached cable	<b>CN-14A-C1</b>	1 m 3.281 ft	0.02 mm <sup>2</sup> 4-core cabtyre cable with connector on one end Cable outer diameter: $\phi$ 3.7 mm $\phi$ 0.146 in
	<b>CN-14A-C3</b>	3 m 9.843 ft	
	<b>CN-14A-C5</b>	5 m 16.404 ft	
M8 connector attached cable	<b>CN-24A-C2</b>	2 m 6.562 ft	For M8 plug-in connector type The connector on one end Cable outer diameter: $\phi$ 4 mm $\phi$ 0.157 in
	<b>CN-24A-C5</b>	5 m 16.404 ft	
Connector	<b>CN-14A</b>	Set of 10 housings and 40 contacts	
Protection cover	<b>FC-FX-1</b>	This protects the operating surfaces.	
Amplifier mounting bracket	<b>MS-DIN-4</b>	Mounting bracket for amplifier	
End plates	<b>MS-DIN-E</b>	When it moves depending on the way it is installed on a DIN rail, these end plates ensure that all amplifiers are mounted together in a secure and fully connected manner. <span style="border: 1px solid black; padding: 2px;">Two pcs. per set</span>	

### M8 connector attached cable

- **CN-24A-C**

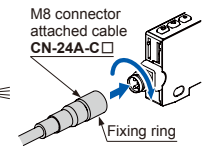
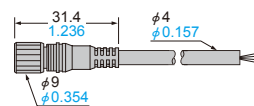

### Protection cover

- **FC-FX-1**

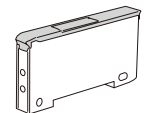

### Amplifier mounting bracket

- **MS-DIN-4**

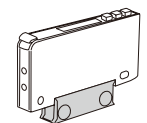

### Connector attached cable

- **CN-14A-C**



### Connector

- **CN-14A**

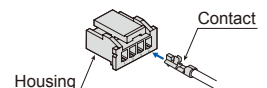

## SPECIFICATIONS

Item	Model No.	Type	Standard type		Long sensing range type		
				Cable set		Cable set	
		NPN output	<b>FX-101 (-Z)</b> (Note 4)	<b>FX-101-CC2</b>	<b>FX-102 (-Z)</b> (Note 4)	<b>FX-102-CC2</b>	
		PNP output	<b>FX-101P (-Z)</b> (Note 4)	<b>FX-101P-CC2</b>	<b>FX-102P (-Z)</b> (Note 4)	<b>FX-102P-CC2</b>	
Supply voltage			12 to 24 V DC $\pm$ 10 % Ripple P-P 10 % or less				
Power consumption			Normal operation: 720 mW or less (Current consumption 30 mA or less at 24 V supply voltage) ECO mode: 600 mW or less (Current consumption 25 mA or less at 24 V supply voltage)				
Output			<NPN output type> NPN open-collector transistor • Maximum sink current: 100 mA • Applied voltage: 30 V DC or less (between output and 0 V) • Residual voltage: 1.5 V or less (at 100 mA sink current)		<PNP output type> PNP open-collector transistor • Maximum source current: 100 mA • Applied voltage: 30 V DC or less (between output and + V) • Residual voltage: 1.5 V or less (at 100 mA source current)		
			Output operation				Selectable either Light-ON or Dark-ON, at SET mode
			Short-circuit protection				Incorporated
External input			<NPN output type> NPN non-contact input • Signal condition High: + 8 V to + V DC or Open Low: 0 to + 2 V DC (Source current 0.5 mA or less) • Input impedance: 10 k $\Omega$ approx.		<PNP output type> PNP non-contact input • Signal condition High: + 4 V to + V DC (Sink current 0.5 to 3 mA or less) Low: 0 to + 0.6 V DC or Open • Input impedance: 10 k $\Omega$ approx.		
			Response time			Emission frequency 0: 250 $\mu$ s or less Emission frequency 1: 450 $\mu$ s or less Emission frequency 2: 500 $\mu$ s or less Emission frequency 3: 600 $\mu$ s or less	
Sensitivity setting			2-level teaching / Limit teaching / Full-auto teaching				
Operation indicator			Orange LED (lights up when the output is ON)				
Digital display			4 digit green + 4 digit red LCD display				
Fine sensitivity adjustment function			Incorporated				
Timer function			ON-delay / OFF-delay timer, switchable either effective or ineffective. [Timer period: 1 ms, 5 ms, 10 ms, 20 ms, 40 ms, 50 ms, 100 ms, 500 ms, 1,000 ms]				
Light emitting amount selection function			Incorporated / Switchable either effective or ineffective				
Interference prevention function			Incorporated Selectable emission frequency method (Note 2) (Functions at emission frequency 1, 2 or 3)		Incorporated Selectable emission frequency method (Note 2) (Functions at emission frequency 1, 2, 3 or 4)		
Environmental resistance	Ambient temperature		- 10 to + 55 °C + 14 to + 131 °F (If 4 to 7 units are mounted close together: - 10 to + 50 °C + 14 to + 122 °F, if 8 to 16 units are : - 10 to + 45 °C + 14 to + 113 °F (No dew condensation or icing allowed), Storage: - 20 to + 70 °C - 4 to + 158 °F				
	Ambient humidity		35 to 85 % RH, Storage: 35 to 85 % RH				
	Ambient illuminance		Incandescent light: 3,000 lx at the light-receiving face				
	Voltage withstandability		1,000 V AC for one min. between all supply terminals connected together and enclosure (Note 3)				
	Insulation resistance		20 M $\Omega$ , or more, with 250 V DC megger between all supply terminals connected together and enclosure (Note 3)				
	Vibration resistance		10 to 150 Hz frequency, 0.75 mm 0.030 in amplitude in X, Y and Z directions for two hours each				
Shock resistance		98 m/s <sup>2</sup> acceleration (10 G approx.) in X, Y and Z directions for five times each					
Emitting element (modulated)			Red LED (Peak emission wavelength : 632 nm)				
Material			Enclosure: Polycarbonate, Key switch: Polycarbonate, Fiber lock lever: PBT				
Connecting method			Connector (Note 4)				
Cable extension			Extension up to total 100 m 328.084 ft is possible with 0.3 mm <sup>2</sup> , or more, cable.				
Weight			Net weight: 15 g approx. Gross weight: 35 g approx.	Net weight: 15 g approx. Gross weight: 75 g approx.	Net weight: 15 g approx. Gross weight: 35 g approx.	Net weight: 15 g approx. Gross weight: 75 g approx.	
Accessory			_____		<b>CN-14A-C2</b> (Connector attached cable, 2 m 6.562 ft long):1pc	_____	
					<b>CN-14A-C2</b> (Connector attached cable, 2 m 6.562 ft long):1pc		

Notes: 1) Where measurement conditions have not been specified precisely, the conditions used were ambient temperature + 23 °C + 73.4 °F.

2) When using the interference prevention function, set the emission frequencies for the amplifiers to be covered by the interference prevention function to different frequency values.

However, the interference prevention function does not operate at emission frequency 0 (factory default setting) for the **FX-101(P)(-Z) / FX-101(P)-CC2**.

3) The voltage withstandability and the insulation resistance values given in the above table are for the amplifier only.

4) Connector attached cable **CN-14A-C2** is not attached to the models that have no '-CC2' at the end of the model names.

Make sure to use the optional cable with connector **CN-14A-C**.

Model Nos. having the suffix '-Z' are M8 plug-in connector type. Make sure to use the optional M8 plug-in connector cable.

## I/O CIRCUIT AND WIRING DIAGRAMS

### FX-10□(-Z/-CC2)

NPN output type

#### I/O circuit diagram

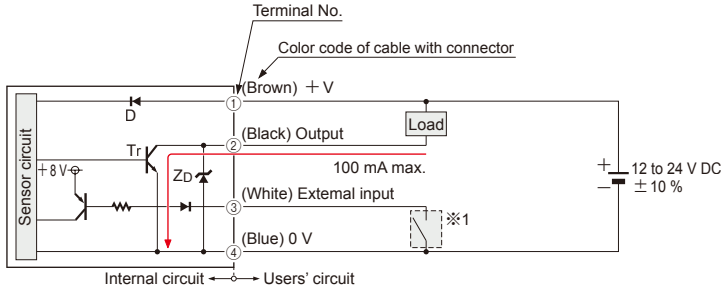

Symbols ... D : Reverse supply polarity protection diode  
ZD: Surge absorption zener diode  
Tr : NPN output transistor

※1

Non-voltage contact or NPN open-collector transistor

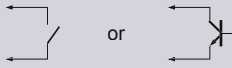

High (+ 8 V to + V DC or open): Ineffective  
Low [(0 to + 2 V DC (source current 0.5 mA or less))]: Effective

#### Terminal arrangement diagram

##### Connector type

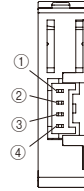

Terminal No.	Function
①	+ V
②	Output
③	External input
④	0 V

##### M8 plug-in connector type

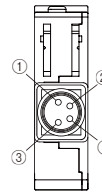

Terminal No.	Function
①	+ V
②	Output
③	External input
④	0 V

### FX-10□P(-Z/-CC2)

PNP output type

#### I/O circuit diagram

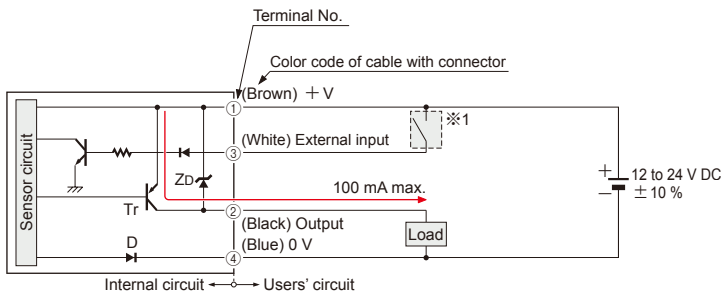

Symbols ... D : Reverse supply polarity protection diode  
ZD: Surge absorption zener diode  
Tr : PNP output transistor

※1

Non-voltage contact or PNP open-collector transistor

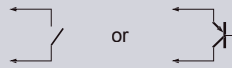

High [+ 4 V to + V DC (sink current 0.5 to 3 mA)]: Effective  
Low (0 to + 0.6V DC or open): Ineffective

#### Terminal arrangement diagram

##### Connector type

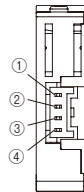

Terminal No.	Function
①	+ V
②	Output
③	External input
④	0 V

##### M8 plug-in connector type

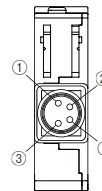

Terminal No.	Function
①	+ V
②	Output
③	External input
④	0 V



LIST OF FIBERS

Pliable fibers (flexible and sharp bending fibers) are marked with light blue in the table.

Thru-beam type (one pair set)



Type	Shape of fiber head (mm in)	Sensing range (mm in)(Note)		Fiber cable length ✂️: Free-cut	Bending radius	Model No.		
		Standard type FX-101□	Long sensing range type FX-102□					
Threaded type	M4	Lens mountable 	400 15.748	1,150 45.276	✂️ 2 m 6.562 ft	R25 mm R0.984 in	FT-B8	
		Lens mountable 						FT-FM2
		Sleeve 90 mm 3.543 in $\phi$ 1.48 $\phi$ 0.058 	300 11.811	800 31.496			Fiber R25 mm R0.984 in Sleeve R10 mm R0.394 in	FT-FM2S
		Sleeve 40 mm 1.575 in $\phi$ 1.48 $\phi$ 0.058 						FT-FM2S4
		Lens mountable 	260 10.236	650 25.591			R1 mm R0.039 in	FT-W8
		Lens mountable 	230 9.055	650 25.591			R4 mm R0.157 in Flexible	FT-P80
		Lens mountable Tough flexible 	260 10.236	800 31.496		1 m 3.281 ft	R10 mm R0.394 in	FT-P81X
		Lens mountable 	130 5.118	300 11.811		✂️ 2 m 6.562 ft	R4 mm R0.157 in Flexible	FT-P60
	Nut type	 W7 × H9 × D13.9 W0.276 × H0.354 × D0.547	215 8.465	570 22.441	✂️ 2 m 6.562 ft	R1 mm R0.039 in	NEW FT-WR80	
			With lens  W7 × H9 × D14.6 W0.276 × H0.354 × D0.575	430 16.929			1,150 45.276	NEW FT-WR80L
		Elbow 	Lens mountable	180 7.087	430 16.929	✂️ 2 m 6.562 ft	R25 mm R0.984 in	FT-R80
	M3	Lens mountable (except FX-LE2) 	300 11.811	800 31.496	✂️ 2 m 6.562 ft	R25 mm R0.984 in	FT-T80	
		Sleeve 90 mm 3.543 in $\phi$ 0.88 $\phi$ 0.035 	130 5.118	280 11.024			Fiber R25 mm R0.984 in Sleeve R10 mm R0.394 in	FT-NFM2S
		Sleeve 40 mm 1.575 in $\phi$ 0.88 $\phi$ 0.035 						FT-NFM2S4
		80 3.150	220 8.661			R1 mm R0.039 in	FT-W4	
		80 3.150	240 9.449			R4 mm R0.157 in Flexible	FT-P40	
Long sensing range 		With lens	9,300 366.141	15,000 590.550		✂️ 10 m 32.808 ft	R25 mm R0.984 in	FT-FM10L

Note: Please take care that the sensing range of the free-cut type fiber may be reduced by 20 % max. depending upon how the fiber is cut.

## LIST OF FIBERS

Pliable fibers (flexible and sharp bending fibers) are marked with light blue in the table.

### Thru-beam type (one pair set)

















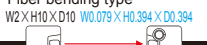

Type	Shape of fiber head (mm in)	Sensing range (mm in)(Note)		Fiber cable length ✂: Free-cut	Bending radius	Model No.	
		Standard type FX-101□	Long sensing range type FX-102□				
Cylindrical type	With lens • Long sensing range φ3 φ0.118	600 23.622	1,500 59.055	✂ 2 m 6.562 ft	R1 mm R0.039 in	FT-WS8L	
		150 5.906	600 23.622			FT-WS3	
	With lens • Long sensing range φ2.5 φ0.098	760 29.921	2,400 94.488	✂ 2 m 6.562 ft	R25 mm R0.984 in	FT-SFM2L	
		300 11.811	800 31.496			FT-SFM2	
		260 10.236	650 25.591			FT-WS8	
	φ1.5 φ0.059	130 5.118	280 11.024	✂ 2 m 6.562 ft	R25 mm R0.984 in	FT-SNFM2	
		80 3.150	220 8.661			FT-WS4	
		120 4.724	330 12.992	1 m 3.281 ft	R4 mm R0.157 in Flexible	FT-P2	
	φ1 φ0.039	40 1.575	90 3.543	500 mm 19.685 in		FT-PS1	
	Ultra-small diameter	Beam diameter φ0.125 mm φ0.005 in φ0.010 φ0.118	6 0.236	19 0.748	500 mm 19.685 in	R5 mm R0.197 in	FT-E12
		Sleeve part cannot be bent.					
		Beam diameter φ0.25 mm φ0.010 in φ0.016 φ0.118	15 0.591	60 2.362	1 m 3.281 ft		FT-E22
Side-view	φ4 φ0.157	1,000 39.370	2,350 92.520	✂ 2 m 6.562 ft	R25 mm R0.984 in	FT-V10	
	φ1.5 φ0.059 φ2.5 φ0.098	180 7.087	470 18.504			FT-SFM2SV2	
	φ1 φ0.039 φ2 φ0.079	140 5.512	380 14.961	1 m 3.281 ft		FT-V22	
	φ1 φ0.039 φ2.5 φ0.098	40 1.575	120 4.724	✂ 2 m 6.562 ft		FT-V41	
	φ1 φ0.039 φ2 φ0.079	30 1.181	80 3.150			R1 mm R0.039 in	FT-WV42
	Sleeve part cannot be bent.						

Note: Please take care that the sensing range of the free-cut type fiber may be reduced by 20 % max. depending upon how the fiber is cut.

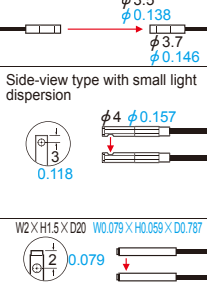
LIST OF FIBERS

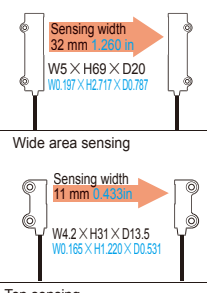
Pliable fibers (flexible and sharp bending fibers) are marked with light blue in the table.

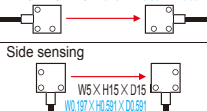
Thru-beam type (one pair set) 

Type	Shape of fiber head (mm in)	Sensing range (mm in)(Note 1)		Fiber cable length  : Free-cut	Bending radius	Model No.	
		Standard type FX-101□	Long sensing range type FX-102□				
Rectangular	Easy mounting • Top sensing W3 × H8 × D12 W0.118 × H0.315 × D0.472 	1,200 47.244	2,800 110.236	 2 m 6.562 ft	R1 mm R0.039 in	FT-WZ8H	
		1,400 55.118	3,100 122.047		R4 mm R0.157 in Flexible	FT-Z8H	
	Easy mounting • Side sensing W3 × H12 × D8 W0.118 × H0.472 × D0.315 	700 27.559	2,100 82.677		R1 mm R0.039 in	FT-WZ8E	
		800 31.496	1,850 72.835		R4 mm R0.157 in Flexible	FT-Z8E	
	Easy mounting • Front sensing W8.5 × H12 × D3 W0.335 × H0.472 × D0.118 	330 12.992	950 37.402		R1 mm R0.039 in	FT-WZ8	
		360 14.173	1,000 39.370		R4 mm R0.157 in Flexible	FT-Z8	
	Front sensing W10 × H7 × D2 W0.394 × H0.276 × D0.079 	230 9.055	670 26.378		 1 m 3.281 ft	NEW R1 mm R0.039 in	FT-WZ4
	Fiber bending type W2 × H10 × D10 W0.079 × H0.394 × D0.394 	80 3.150	230 9.055		 2 m 6.562 ft	NEW	FT-WZ4HB
	Front sensing W14 × H7 × D3.5 W0.551 × H0.276 × D0.138 	330 12.992	1,000 39.370			NEW	FT-WZ7
	Fiber bending type W3.5 × H14 × D11 W0.138 × H0.551 × D0.433 	190 7.480	580 22.835			NEW	FT-WZ7HB
Special	Narrow beam 	1,000 39.370	3,000 118.110	 2 m 6.562 ft		R25 mm R0.984 in	FT-K8
		700 27.559	2,200 86.614		R1 mm R0.039 in	FT-WKV8	
		1,000 39.370	3,000 118.110		R25 mm R0.984 in	FT-KV8	
		135 5.315	500 19.685		R10 mm R0.394 in	FT-KV1	
Special	Wide beam 	(Note 2) 3,500 137.795	(Note 2) 3,500 137.795	 2 m 6.562 ft	R1 mm R0.039 in	FT-WA30	
					R10 mm R0.394 in	FT-A30	
		1,500 59.055	(Note 2) 3,500 137.795		R1 mm R0.039 in	FT-WA8	
					R10 mm R0.394 in	FT-A8	
Special	Array 	280 11.024	600 23.622	 2 m 6.562 ft	R25 mm R0.984 in	FT-AFM2	
		240 9.449	670 26.378		FT-AFM2E		

Notes: 1) Please take care that the sensing range of the free-cut type fiber may be reduced by 20 % max. depending upon how the fiber is cut.  
2) The fiber cable length practically limits the sensing range to 3,500 mm 137.795 in long.

## LIST OF FIBERS

### Thru-beam type (one pair set)



Type	Shape of fiber head (mm in)	Sensing range (mm in)(Note 1)		Fiber cable length ✂: Free-cut	Bending radius	Model No.
		Standard type FX-101□	Long sensing range type FX-102□			
Heat-resistant	350 °C 662 °F Lens mountable 			2 m 6.562 ft	R25 mm R0.984 in	FT-H35-M2
	350 °C 662 °F Sleeve 60 mm 2.362 in M4 $\phi 2.1$ $\phi 0.083$ 	170 6.693	490 19.291			
	200 °C 392 °F Lens mountable 	100 3.937	300 11.811	1 m 3.281 ft	R10 mm R0.394 in	FT-H20W-M1
	200 °C 392 °F Lens mountable 	210 8.268	540 21.260	1 m 3.281 ft	R25 mm R0.984 in	FT-H20-M1
	130 °C 266 °F Lens mountable (FX-LE2 only) 	250 9.843	700 27.559	2 m 6.562 ft		FT-H13-FM2
	Special Heat-resistant • Joint	Lens mountable (FX-LE1) 	135 5.315	420 16.535	200 mm 7.874 in (Note 2) ✂	Heat-resistant fiber R18 mm R0.709 in (Note 3)
Side-view 		150 5.906	500 19.685	300 mm 11.811 in (Note 2) ✂	<b>NEW</b> FT-H20-J30-S (Note 4)	
				500 mm 19.685 in (Note 2) ✂	<b>NEW</b> FT-H20-J50-S (Note 4)	
				800 mm 31.496 in (Note 2) ✂	<b>NEW</b> FT-H20-VJ50-S (Note 4)	
					<b>NEW</b> FT-H20-VJ80-S (Note 4)	
Chemical-resistant	Easy mounting • Rectangular head SEMI S2 compliant W7 × H15 × D13 W0.276 × H0.591 × D0.512 	520 20.472	3,100 122.047	2 m 6.562 ft	R25 mm R0.984 in	FT-Z802Y
	$\phi 5.5$ $\phi 0.217$ 	1,100 43.307	2,600 102.362	2 m 6.562 ft (Note 5)	R30 mm R1.181 in	FT-L80Y
	Side-view $\phi 5.5$ $\phi 0.217$ 	340 13.386	800 31.496			FT-V80Y
Vacuum-resistant	300 °C 572 °F Lens mountable (FV-LE1/SV2 only) 	110 4.331	280 11.024	1 m 3.281 ft	R18 mm R0.709 in	FT-H30-M1V-S (Note 6)

- Notes: 1) Please take care that the sensing range of the free-cut type fiber may be reduced by 20 % max. depending upon how the fiber is cut.  
 2) This is the fiber length (fixed length) for heat-resistant fibers. The ordinary-temperature fibers are free-cut to 2 m 6.562 ft.  
 3) The ordinary-temperature side is R25 mm R0.984 in or more.  
 4) Heat-resistant joint fibers and ordinary-temperature fibers (FT-FM2) are sold as a set. Please refer to 'Heat-resistant joint fiber catalog' for details.  
 5) The allowable cutting range is 500 mm 19.685 in from the end that the amplifier inserted.  
 6) Sold as a set comprising vacuum-resistant type fiber + photo-terminal (FV-BR1) + fiber at atmospheric side (FT-J8). Please refer to 'Vacuum-resistant fiber catalog' for details.

### Model No. when ordering heat-resistant joint fibers individually as replacement parts

- FT-H20-J20 (one pair set)
- FT-H20-J30 (one pair set)
- FT-H20-J50 (one pair set)
- FT-H20-VJ50 (one pair set)
- FT-H20-VJ80 (one pair set)

### Model No. when ordering vacuum-resistant fibers individually as replacement parts

- Vacuum-resistant type fiber FT-H30-M1V (one pair set)
- Photo-terminal FV-BR1 (one pair set)
- Fiber at atmospheric side FT-J8 (one pair set)

LIST OF FIBERS

Pliable fibers (flexible and sharp bending fibers) are marked with light blue in the table.

Retroreflective type

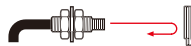

Type	Shape of fiber head (mm in)	Sensing range (mm in)(Note 1, 2)		Fiber cable length Free-cut	Bending radius	Model No.
		Standard type FX-101	Long sensing range type FX-102			
Sharp bending With polarizing filters	W9.5 X H5.2 X D15 W0.374 X H0.205 X D0.591 W30 X H30 X D0.5 W1.181 X H1.181 X D0.1020	100 to 550 3.937 to 21.654	100 to 830 3.937 to 32.677	2 m 6.562 ft	R1 mm R0.039 in	FR-WKZ11
	Narrow beam Top sensing	W9.5 X H5.2 X D21 W0.374 X H0.205 X D0.827 W10.6 X H28 X D10.1 W0.417 X H1.102 X D0.398	200 7.874	200 7.874	2 m 6.562 ft	R10 mm R0.394 in
Side sensing		W9.5 X H25 X D52 W0.374 X H0.984 X D0.205 W10.6 X H28 X D10.1 W0.417 X H1.102 X D0.398				
Wafer mapping	W7.5 X H2.2 X D11.2 W0.295 X H0.087 X D0.441 W4 X H2 X D21.5 W0.157 X H0.079 X D0.846	15 to 200 0.591 to 7.874	15 to 360 0.591 to 14.173	2 m 6.562 ft	R10 mm R0.394 in	FR-KV1

Notes: 1) Please take care that the sensing range of the free-cut type fiber may be reduced by 20 % max. depending upon how the fiber is cut. The sensing range of **FR-WKZ11** is specified for the **RF-13**. The sensing range of **FR-KZ21**, **FR-KZ21E** and **FR-KV1** is specified for the attached reflector. The sensing ranges when using in combination with the **FR-WKZ11** reflector (optional) are given in the below table.

Reflector	Amplifier	FX-101	FX-102
FR-WKZ11 + RF-210		100 to 700 3.937 to 27.559	100 to 1,100 3.937 to 43.307
FR-WKZ11 + RF-220		100 to 1,300 3.937 to 51.181	100 to 2,600 3.937 to 102.362
FR-WKZ11 + RF-230		100 to 2,000 3.937 to 78.740	100 to 4,000 3.937 to 157.480

- 2) The sensing range of **FR-WKZ11** is the possible setting range for the reflector or reflective tape. The fiber can detect an object less than 100 mm 3.937 in away. However, note that if there are any white or highly-reflective surfaces near the fiber head, reflected incident light may affect the fiber head. If this occurs, adjust the threshold value of the amplifier unit before use.  
The sensing range of **FR-KZ21(E)** is the possible setting range for the reflector. However, if setting the fiber to detect objects passing within 0 to 20 mm 0 to 0.787 in from the fiber head, unstable detection may result.  
The sensing range of **FR-KV1** is the possible setting range for the reflector. The fiber can detect an object less than 15 mm 0.591 in away.

Reflective type



Type	Shape of fiber head (mm in)	Sensing range (mm in)(Note 1, 2)		Fiber cable length Free-cut	Bending radius	Model No.
		Standard type FX-101	Long sensing range type FX-102			
Threaded type	M6	170 6.693	440 17.323	2 m 6.562 ft	R25 mm R0.984 in	FD-B8
	Coaxial M6	100 3.937	410 16.142		FD-FM2	
	Sleeve 90 mm 3.543 in	100 3.937	345 13.583		Fiber R25 mm R0.984 in	FD-FM2S
	Sleeve 40 mm 1.575 in				R10 mm R0.394 in	FD-FM2S4
	M6	80 3.150	230 9.055		R1 mm R0.039 in	FD-W8
	M6	90 3.543	200 7.874		R4 mm R0.157 in	FD-P80
	M6	70 2.756	220 8.661		R10 mm R0.394 in	FD-P81X
	Tough flexible			1 m 3.281 ft		
Elbow	M6	70 2.756	180 7.087	2 m 6.562 ft	R25 mm R0.984 in	FD-R80

Notes: 1) The sensing range is specified for white non-glossy paper (400×400 mm 15.748×15.748 in) as the object.  
2) Please take care that the sensing range of the free-cut type fiber may be reduced by 20 % max. depending upon how the fiber is cut.

## LIST OF FIBERS

Pliable fibers (flexible and sharp bending fibers) are marked with light blue in the table.

### Reflective type



Type	Shape of fiber head (mm in)	Sensing range (mm in)(Note 1, 2)		Fiber cable length ✂: Free-cut	Bending radius	Model No.
		Standard type FX-101□	Long sensing range type FX-102□			
Threaded type	M4	110 4.331	345 13.583	2 m 6.562 ft	R25 mm R0.984 in	FD-T80
	M4				R25 mm R0.984 in	FD-NFM2
	Sleeve 90 mm 3.543 in M4	35 1.378	100 3.937		Fiber R25 mm R0.984 in	FD-NFM2S
	Sleeve 40 mm 1.575 in M4				Sleeve R10 mm R0.394 in	FD-NFM2S4
	Sleeve 40 mm 1.575 in M4	15 0.591	40 1.575		Fiber R1 mm R0.039 in Sleeve R10 mm R0.394 in	FD-W44
	M4	80 3.150	230 9.055		R1 mm R0.039 in	FD-WT8
	Small spot for sensing minute objects Coaxial • Lens mountable	28 1.102	75 2.953		R2 mm R0.079 in	FD-WG4
	M4	50 1.969	120 4.724		R25 mm R0.984 in	FD-G4
	M4	45 1.772	150 5.906		R4 mm R0.157 in Flexible	FD-P60
	M3	35 1.378	100 3.937		R25 mm R0.984 in	FD-T40
	M3	15 0.591	40 1.575		R1 mm R0.039 in	FD-WT4
	M3	8 0.315	30 1.181		R4 mm R0.157 in Flexible	FD-P40
	Lens mountable (FX-MR3, FX-MR6) M3	50 1.969	120 4.724		R25 mm R0.984 in	FD-G6
	Coaxial Lens mountable (FX-MR3, FX-MR6) M3	45 1.772	160 6.299		R10 mm R0.394 in	FD-G6X
Coaxial Tough flexible Coaxial • Lens mountable (FX-MR3, FX-MR6) M3	18 0.709	50 1.969	R25 mm R0.984 in	FD-EG1		
High precision Coaxial • Lens mountable (FX-MR3, FX-MR6) M3	10 0.394	30 1.181	500 mm 19.685 in	R10 mm R0.394 in	FD-EG2	
High precision Coaxial • Lens mountable (FX-MR3, FX-MR6) M3	7 0.276	22 0.866			FD-EG3	
High precision Coaxial • Lens mountable (FX-MR3, FX-MR6) M3	1 0.039	4 0.157			R25 mm R0.984 in	FD-EN500S1
Sleeve part cannot be bent. Coaxial M3	15 0.591	48 1.890	1 m 3.281 ft	R25 mm R0.984 in	FD-ENM1S1	
Sleeve part cannot be bent.						

Notes: 1) The sensing range is specified for white non-glossy paper [200×200 mm 7.874×7.874 in (FD-T80, FD-WT8: 400×400 mm 15.748×15.748 in, FD-W44, FD-WT4, FD-P40, FD-G6, FD-EG1, FD-EG2, FD-EG3, FD-EN500S1, FD-ENM1S1: 100×100 mm 3.937×3.937 in)] as the object.  
 2) Please take care that the sensing range of the free-cut type fiber may be reduced by 20 % max. depending upon how the fiber is cut.  
 3) The allowable cutting range is 700 mm 27.559 in from the end that the amplifier inserted.

LIST OF FIBERS

Pliable fibers (flexible and sharp bending fibers) are marked with light blue in the table.

Reflective type



Type	Shape of fiber head (mm in)	Sensing range (mm in)(Note 1, 2)		Fiber cable length : Free-cut	Bending radius	Model No.		
		Standard type FX-101	Long sensing range type FX-102					
Cylindrical type	φ3 φ0.118		100 3.937	345 13.583	2 m 6.562 ft	R25 mm R0.984 in	FD-S80	
			80 3.150	230 9.055		R1 mm R0.039 in	FD-WS8	
		Coaxial 	28 1.102	75 2.953		R2 mm R0.079 in	FD-WSG4	
			45 1.772	150 5.906		R4 mm R0.157 in Flexible	FD-P50	
	φ2.5 φ0.098		35 1.378	100 3.937	2 m 6.562 ft	R25 mm R0.984 in	FD-SNFM2	
		φ1.5 φ0.059	25 0.984	65 2.559		R4 mm R0.157 in Flexible	FD-P2	
	Ultra-small diameter	φ1.5 φ0.059 φ0.020		3.5 0.138	13 0.512	1 m 3.281 ft	R10 mm R0.394 in	FD-E12
			Coaxial 	16 0.630	45 1.772		R25 mm R0.984 in	FD-E22
		Small diameter φ0.65 φ0.026	25 0.984	70 2.756	R25 mm R0.984 in		FD-V41	
	Side-view	φ3 φ0.118 φ0.079		6 0.236	20 0.787	2 m 6.562 ft	R1 mm R0.039 in	FD-WV42
			30 1.181	90 3.543	R25 mm R0.984 in		FD-SFM2SV2	
φ5 φ0.197 φ0.079 φ0.031		30 1.181	90 3.543	R25 mm R0.984 in	FD-SFM2SV2			
Rectangular	Glass substrate detection • Mapping		16 to 30 0.630 to 1.181	12 to 50 0.472 to 1.969	4 m 13.123 ft	R25 mm R0.984 in	FD-L46	
		W25 X H7.3 X D30 W0.984 X H0.287 X D1.181	0 to 40 0 to 1.575	0 to 50 0 to 1.969		3 m 9.843 ft	R4 mm R0.157 in	FD-L45
		W20 X H29 X D3.8 W0.787 X H1.142 X D0.150	0 to 19 0 to 0.748	0 to 25 0 to 0.984		2 m 6.562 ft	R25 mm R0.984 in	FD-L43
	Glass substrate detection • Alignment	W17 X H29 X D3.8 W0.669 X H1.142 X D0.150	0 to 6 0 to 0.236	0 to 8 0 to 0.315	2 m 6.562 ft	R10 mm R0.394 in	FD-L44	
		W12 X H19 X D3 W0.472 X H0.748 X D0.118	0 to 4.5 0 to 0.177	0 to 5.5 0 to 0.217		R25 mm R0.984 in	FD-L44S	
	Glass substrate detection • Seating		7 to 12 0.276 to 0.472 (Convergent point 8 0.315)	6 to 13.5 0.236 to 0.531 (Convergent point 8 0.315)	2 m 6.562 ft	R1 mm R0.039 in	FD-WL41	
			3 to 14 0.118 to 0.551 (Convergent point 8 0.315)	1.5 to 16 0.059 to 0.630 (Convergent point 8 0.315)		R10 mm R0.394 in	FD-L41	
		W24 X H21 X D4 W0.945 X H0.827 X D0.157	5 to 8 0.197 to 0.315 (Convergent point 6 0.236)	1 to 17 0.039 to 0.669 (Convergent point 6 0.236)		R10 mm R0.394 in	FD-L4	
		W6 X H18 X D14 W0.236 X H0.709 X D0.551	1 to 4.5 0.039 to 0.177	0.5 to 6.5 0.020 to 0.256		R1 mm R0.039 in	FD-WL48	
W7.2 X H7.5 X D2 W0.283 X H0.295 X D0.079	1 to 4.5 0.039 to 0.177	0.5 to 6.5 0.020 to 0.256	1 m 3.281 ft	R1 mm R0.039 in	FD-WL48			

Notes: 1) The sensing range is specified for white non-glossy paper (FD-S80, FD-WS8: 400×400 mm 15.748×15.748 in, FD-WSG4, FD-P50, FD-SNFM2, FD-V41, FD-SFM2SV2: 200×200 mm 7.874×7.874 in, FD-P2, FD-E12, FD-E22, FD-WV42, FD-L4, FD-WL48: 100×100 mm 3.937×3.937 in, FD-L46: 100×100×t 0.7 mm 3.937×3.937×t 0.028 in R edge of LCD glass substrates, FD-L43, FD-L44 and FD-L45: 100×100×t 0.7 mm 3.937×3.937×t 0.028 in LCD glass substrates, FD-L44S: silicon wafers polished surface, FD-WL41, FD-L41: 100×100×t 2 mm 3.937×3.937×t 0.079 in glass substrates)  
2) Please take care that the sensing range of the free-cut type fiber may be reduced by 20 % max. depending upon how the fiber is cut.

## LIST OF FIBERS

Pliable fibers (flexible and sharp bending fibers) are marked with light blue in the table.

### Reflective type



Type	Shape of fiber head (mm in)	Sensing range (mm in) (Note 1, 2)		Fiber cable length ✂️: Free-cut	Bending radius	Model No.
		Standard type FX-101□	Long sensing range type FX-102□			
Rectangular Compact	Front sensing  W10 X H7 X D2 W0.394 X H0.276 X D0.079	2 to 20 0.079 to 0.787	1 to 70 0.039 to 2.756	✂️ 1 m 3.281 ft	R1 mm R0.039 in	NEW FD-WZ4
	Fiber bending type  W2 X H10 X D10 W0.079 X H0.394 X D0.394					NEW FD-WZ4HB
	Front sensing  W14 X H7 X D3.5 W0.551 X H0.276 X D0.138	1 to 55 0.039 to 2.165	160 6.299	✂️ 2 m 6.562 ft		NEW FD-WZ7
	Fiber bending type  W3.5 X H14 X D11 W0.138 X H0.551 X D0.433	1 to 60 0.039 to 2.362	0.5 to 180 0.020 to 7.087			NEW FD-WZ7HB
Long sensing range	Long sensing range • Rectangular head  W5.2 X H9.5 X D15 W0.205 X H0.374 X D0.591	20 to 180 0.787 to 7.087	20 to 480 0.787 to 18.898	✂️ 2 m 6.562 ft	R1 mm R0.039 in	FD-WKZ1
Wide beam	 W7 X H15 X D30 W0.276 X H0.591 X D1.181	125 4.921	250 9.843	✂️ 2 m 6.562 ft	R25 mm R0.984 in	FD-A15
Special Array	Top sensing  W5 X H15 X D15 W0.197 X H0.591 X D0.591	105 4.134	285 11.220	✂️ 2 m 6.562 ft	R25 mm R0.984 in	FD-AFM2
	Side sensing  W5 X H20 X D20 W0.197 X H0.787 X D0.787	85 3.346	245 9.646			FD-AFM2E
Liquid level sensing	Contact type  φ6 φ0.236			✂️ 2 m 6.562 ft (Note 3)	Protective tube R40 mm R1.575 in Fiber R15 mm R0.591 in	FD-F8Y
	Mountable on pipe • Standard  W25 X H13 X D20 W0.984 X H0.512 X D0.787	Applicable pipe diameter: Outer dia. φ6 to φ26 mm φ0.236 to φ1.024 in transparent pipe [PVC (vinyl chloride), fluorine resin, polycarbonate, acrylic, glass, wall thickness 1 to 3 mm 0.039 to 0.118 in]		✂️ 2 m 6.562 ft	R10 mm R0.394 in	FD-F41
	Mountable on pipe • For PFA, wall thickness 1 mm 0.039 in pipe  W25 X H13 X D20 W0.984 X H0.512 X D0.787	Applicable pipe diameter: Outer dia. φ6 to φ26 mm φ0.236 to φ1.024 in transparent pipe [PFA (fluorine resin) or equivalently transparent pipe, wall thickness 1 mm 0.039 in]				FD-F4

Notes: 1) The sensing range is specified for white non-glossy paper [200×200 mm 7.874×7.874 in (FD-WKZ1, FD-AFM2, FD-AFM2E: 400×400 mm 15.478×15.478 in)] as the object.

2) Please take care that the sensing range of the free-cut type fiber may be reduced by 20 % max. depending upon how the fiber is cut.

3) The allowable cutting range is 1,000 mm 39.370 in from the end that the amplifier inserted.



LIST OF FIBERS

Reflective type



Type	Shape of fiber head (mm in)	Sensing range (mm in)(Note 1, 2)		Fiber cable length : Free-cut	Bending radius	Model No.	
		Standard type FX-101	Long sensing range type FX-102				
Special	Heat-resistant	350 °C 662 °F • Coaxial M6 	75 2.953	280 11.024	2 m 6.562 ft	R25 mm R0.984 in Fiber R25 mm R0.984 in Sleeve R10 mm R0.394 in	FD-H35-M2
		350 °C 662 °F • Sleeve 60 mm 2.362 in M6 φ2.8 φ0.110 					
		200 °C 392 °F • Coaxial M6 	120 4.724	300 11.811	1 m 3.281 ft	R25 mm R0.984 in	FD-H20-M1
		350 °C 662 °F • Sleeve 90 mm 3.543 in M4 φ2.1 φ0.083 	85 3.346	200 7.874		R25 mm R0.984 in Fiber R25 mm R0.984 in Sleeve R10 mm R0.394 in	FD-H35-20S
		200 °C 392 °F • Coaxial M4 	90 3.543	280 11.024			FD-H20-21
		300 °C 572 °F • Glass substrate detection Convergent reflective type W19 X H27 X D5 W0.748 X H1.063 X D0.197 	2 to 9 0.079 to 0.354	0 to 17 0 to 0.669	2 m 6.562 ft	R25 mm R0.984 in	FD-H30-L32
		180 °C 356 °F • Glass substrate detection Convergent reflective type W19 X H27 X D5 W0.748 X H1.063 X D0.197 	0 to 10 0 to 0.394	0 to 25 0 to 0.984	2 m 6.562 ft		FD-H18-L31
		130 °C 266 °F M6 	100 3.937	280 11.024			FD-H13-FM2
	Vacuum-resistant	300 °C 572 °F • Rectangular head W9.5 X H5.2 X D15 W0.374 X H0.205 X D0.591 	25 to 80 0.984 to 3.150	10 to 220 0.394 to 8.661	1 m 3.281 ft	R18 mm R0.709 in	FD-H30-KZ1V-S (Note 3)
		300 °C 572 °F • Glass substrate detection Convergent reflective type W19 X H5 X D27 W0.748 X H1.063 X D1.063 	2.5 to 6.5 0.098 to 0.256	0 to 11 0 to 0.433	3 m 9.843 ft		FD-H30-L32V-S (Note 3)

Notes: 1) The sensing range is specified for white non-glossy paper [400×400 mm 15.748×15.748 in (FD-H30-L32, FD-H18-L31: 50×50 mm 1.969×1.969 in glass substrate, FD-H30-KZ1V-S, FD-H30-L32V-S: 100×100×t 0.7 mm 3.937×3.937×t 0.028 in transparent glass)] as the object.  
 2) Please take care that the sensing range of the free-cut type fiber may be reduced by 20 % max. depending upon how the fiber is cut.  
 3) Sold as a set comprising vacuum-resistant type fiber + photo-terminal (FV-BR1) + fiber at atmospheric side (FT-J8).

Model No. when ordering vacuum-resistant fibers individually as replacement parts

- Vacuum-resistant type fiber  
FD-H30-KZ1V  
FD-H30-L32V
- Mounting bracket for FD-H30-KZ1V  
MS-FD-2
- Photo-terminal  
FV-BR1 (one pair set)
- Fiber at atmospheric side  
FT-J8 (one pair set)

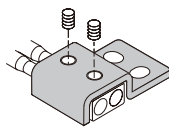

Accessories (attached with fibers)

- RF-003 (FR-KZ21/KZ21E exclusive reflector)
- RF-13 (Reflective tape)
- FX-CT1 (Fiber cutter)
- FX-CT2 (Fiber cutter)
- FX-AT2 (Attachment for fixed-length fiber, Orange)
- FX-AT3 (Attachment for φ2.2 mm φ0.087 in fiber, Clear orange)
- FX-AT4 (Attachment for φ 1 mm φ0.039 in fiber, Black)
- FX-AT5 (Attachment for φ 1.3 mm φ0.051 in fiber, Gray)
- FX-AT6 (Attachment for φ 1 mm φ0.039 in / φ 1.3 mm φ0.051 in mixed fiber, Black / Gray)

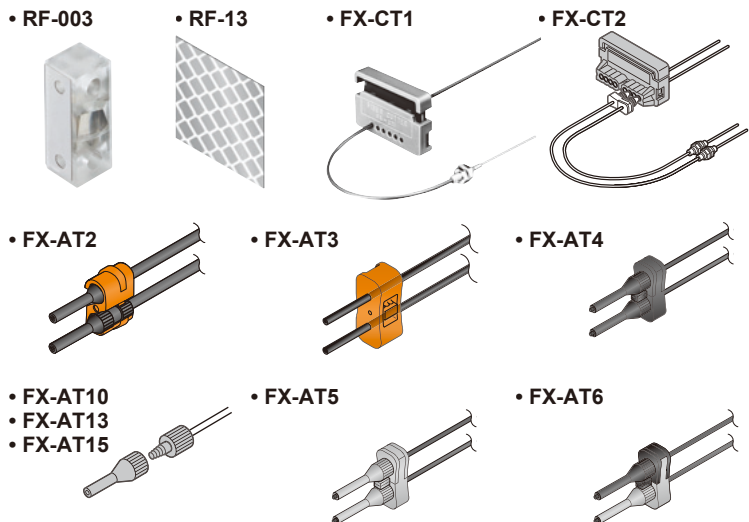



If connecting to a fiber amplifier other than the FX-100 series

- Applicable fiber amplifiers: FX2 / FX3 series
- FX-AT10 (Attachment for φ 1 mm φ0.039 in fiber)
- FX-AT13 (Attachment for φ 1.3 mm φ0.051 in fiber)
- FX-AT15 (Attachment for φ 1 mm φ0.039 in / φ 1.3 mm φ0.051 in mixed fiber)

## FIBER OPTIONS

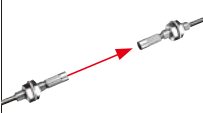
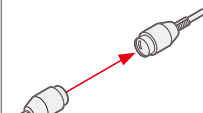
### Lens (For thru-beam type fiber)

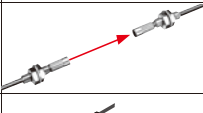
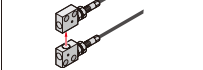
Designation	Model No.	Description																																													
For thru-beam type fiber	Expansion lens (Note 1)	<b>FX-LE1</b>	 <p>Increases the sensing range by 5 times or more.</p> <ul style="list-style-type: none"> <li>Ambient temperature: -60 to +350 °C -76 to +662 °F</li> </ul>																																												
			<p><b>Sensing range (mm) [Lens on both sides]</b></p> <table border="1"> <thead> <tr> <th>Fiber</th> <th>Amplifier</th> <th>FX-101□</th> <th>FX-102□</th> </tr> </thead> <tbody> <tr> <td>FT-B8</td> <td></td> <td>2,200</td> <td>3,500 (Note 2)</td> </tr> <tr> <td>FT-FM2, FT-T80</td> <td></td> <td>3,000</td> <td>3,500 (Note 2)</td> </tr> <tr> <td>FT-R80</td> <td></td> <td>1,900</td> <td>3,500 (Note 2)</td> </tr> <tr> <td>FT-W8</td> <td></td> <td>3,000</td> <td>3,500 (Note 2)</td> </tr> <tr> <td>FT-P80, FT-P60</td> <td></td> <td>3,500 (Note 2)</td> <td>3,500 (Note 2)</td> </tr> <tr> <td>FT-P81X</td> <td></td> <td>1,600 (Note 2)</td> <td>1,600 (Note 2)</td> </tr> <tr> <td>FT-H35-M2</td> <td></td> <td>2,000</td> <td>3,500 (Note 2)</td> </tr> <tr> <td>FT-H20W-M1</td> <td></td> <td>1,300</td> <td>1,600 (Note 2)</td> </tr> <tr> <td>FT-H20-M1</td> <td></td> <td>1,600 (Note 2)</td> <td>1,600 (Note 2)</td> </tr> <tr> <td>FT-H20-J20-S, FT-H20-J30-S, FT-H20-J50-S</td> <td></td> <td>1,000</td> <td>3,500 (Note 2)</td> </tr> </tbody> </table>	Fiber	Amplifier	FX-101□	FX-102□	FT-B8		2,200	3,500 (Note 2)	FT-FM2, FT-T80		3,000	3,500 (Note 2)	FT-R80		1,900	3,500 (Note 2)	FT-W8		3,000	3,500 (Note 2)	FT-P80, FT-P60		3,500 (Note 2)	3,500 (Note 2)	FT-P81X		1,600 (Note 2)	1,600 (Note 2)	FT-H35-M2		2,000	3,500 (Note 2)	FT-H20W-M1		1,300	1,600 (Note 2)	FT-H20-M1		1,600 (Note 2)	1,600 (Note 2)	FT-H20-J20-S, FT-H20-J30-S, FT-H20-J50-S		1,000	3,500 (Note 2)
	Fiber	Amplifier	FX-101□	FX-102□																																											
	FT-B8		2,200	3,500 (Note 2)																																											
	FT-FM2, FT-T80		3,000	3,500 (Note 2)																																											
	FT-R80		1,900	3,500 (Note 2)																																											
FT-W8		3,000	3,500 (Note 2)																																												
FT-P80, FT-P60		3,500 (Note 2)	3,500 (Note 2)																																												
FT-P81X		1,600 (Note 2)	1,600 (Note 2)																																												
FT-H35-M2		2,000	3,500 (Note 2)																																												
FT-H20W-M1		1,300	1,600 (Note 2)																																												
FT-H20-M1		1,600 (Note 2)	1,600 (Note 2)																																												
FT-H20-J20-S, FT-H20-J30-S, FT-H20-J50-S		1,000	3,500 (Note 2)																																												
Super-expansion lens (Note 1)	<b>FX-LE2</b>	 <p>Tremendously increases the sensing range with large diameter lenses.</p> <ul style="list-style-type: none"> <li>Ambient temperature: -60 to +350 °C -76 to +662 °F</li> </ul>																																													
		<p><b>Sensing range (mm) [Lens on both sides]</b></p> <table border="1"> <thead> <tr> <th>Fiber</th> <th>Amplifier</th> <th>FX-101□</th> <th>FX-102□</th> </tr> </thead> <tbody> <tr> <td>FT-B8, FT-FM2, FT-R80, FT-W8, FT-P80, FT-P60</td> <td></td> <td>3,500 (Note 2)</td> <td>3,500 (Note 2)</td> </tr> <tr> <td>FT-P81X</td> <td></td> <td>1,600 (Note 2)</td> <td>1,600 (Note 2)</td> </tr> <tr> <td>FT-H35-M2</td> <td></td> <td>3,500 (Note 2)</td> <td>3,500 (Note 2)</td> </tr> <tr> <td>FT-H20W-M1, FT-H20-M1</td> <td></td> <td>1,600 (Note 2)</td> <td>1,600 (Note 2)</td> </tr> <tr> <td>FT-H13-FM2</td> <td></td> <td>3,500 (Note 2)</td> <td>3,500 (Note 2)</td> </tr> <tr> <td>FT-H20-J20-S, FT-H20-J30-S, FT-H20-J50-S</td> <td></td> <td>3,500 (Note 2)</td> <td>3,500 (Note 2)</td> </tr> </tbody> </table>	Fiber	Amplifier	FX-101□	FX-102□	FT-B8, FT-FM2, FT-R80, FT-W8, FT-P80, FT-P60		3,500 (Note 2)	3,500 (Note 2)	FT-P81X		1,600 (Note 2)	1,600 (Note 2)	FT-H35-M2		3,500 (Note 2)	3,500 (Note 2)	FT-H20W-M1, FT-H20-M1		1,600 (Note 2)	1,600 (Note 2)	FT-H13-FM2		3,500 (Note 2)	3,500 (Note 2)	FT-H20-J20-S, FT-H20-J30-S, FT-H20-J50-S		3,500 (Note 2)	3,500 (Note 2)																	
Fiber	Amplifier	FX-101□	FX-102□																																												
FT-B8, FT-FM2, FT-R80, FT-W8, FT-P80, FT-P60		3,500 (Note 2)	3,500 (Note 2)																																												
FT-P81X		1,600 (Note 2)	1,600 (Note 2)																																												
FT-H35-M2		3,500 (Note 2)	3,500 (Note 2)																																												
FT-H20W-M1, FT-H20-M1		1,600 (Note 2)	1,600 (Note 2)																																												
FT-H13-FM2		3,500 (Note 2)	3,500 (Note 2)																																												
FT-H20-J20-S, FT-H20-J30-S, FT-H20-J50-S		3,500 (Note 2)	3,500 (Note 2)																																												
Side-view lens	<b>FX-SV1</b>	 <p>Beam axis is bent by 90 °.</p> <ul style="list-style-type: none"> <li>Ambient temperature: -60 to +300 °C -76 to +572 °F</li> </ul>																																													
		<p><b>Sensing range (mm) [Lens on both sides]</b></p> <table border="1"> <thead> <tr> <th>Fiber</th> <th>Amplifier</th> <th>FX-101□</th> <th>FX-102□</th> </tr> </thead> <tbody> <tr> <td>FT-B8</td> <td></td> <td>530</td> <td>1,450</td> </tr> <tr> <td>FT-FM2, FT-T80</td> <td></td> <td>550</td> <td>1,700</td> </tr> <tr> <td>FT-W8</td> <td></td> <td>450</td> <td>1,300</td> </tr> <tr> <td>FT-P80</td> <td></td> <td>420</td> <td>1,400</td> </tr> <tr> <td>FT-P60</td> <td></td> <td>300</td> <td>850</td> </tr> <tr> <td>FT-P81X</td> <td></td> <td>550</td> <td>1,700</td> </tr> <tr> <td>FT-H35-M2</td> <td></td> <td>280</td> <td>800</td> </tr> <tr> <td>FT-H20W-M1</td> <td></td> <td>140</td> <td>400</td> </tr> <tr> <td>FT-H20-M1</td> <td></td> <td>280</td> <td>840</td> </tr> <tr> <td>FT-H20-J20-S, FT-H20-J30-S, FT-H20-J50-S</td> <td></td> <td>150</td> <td>410</td> </tr> </tbody> </table>	Fiber	Amplifier	FX-101□	FX-102□	FT-B8		530	1,450	FT-FM2, FT-T80		550	1,700	FT-W8		450	1,300	FT-P80		420	1,400	FT-P60		300	850	FT-P81X		550	1,700	FT-H35-M2		280	800	FT-H20W-M1		140	400	FT-H20-M1		280	840	FT-H20-J20-S, FT-H20-J30-S, FT-H20-J50-S		150	410	
Fiber	Amplifier	FX-101□	FX-102□																																												
FT-B8		530	1,450																																												
FT-FM2, FT-T80		550	1,700																																												
FT-W8		450	1,300																																												
FT-P80		420	1,400																																												
FT-P60		300	850																																												
FT-P81X		550	1,700																																												
FT-H35-M2		280	800																																												
FT-H20W-M1		140	400																																												
FT-H20-M1		280	840																																												
FT-H20-J20-S, FT-H20-J30-S, FT-H20-J50-S		150	410																																												
Expansion lens for vacuum-resistant fiber (Note 1)	<b>FV-LE1</b>	 <p>Sensing range increases by 4 times or more.</p> <ul style="list-style-type: none"> <li>Ambient temperature: -40 to +120 °C -40 to +248 °F</li> </ul>																																													
		<p><b>Sensing range (mm) [Lens on both sides] (Note 3)</b></p> <table border="1"> <thead> <tr> <th>Fiber</th> <th>Amplifier</th> <th>FX-101□</th> <th>FX-102□</th> </tr> </thead> <tbody> <tr> <td>FT-H30-M1V</td> <td></td> <td>450</td> <td>1,600</td> </tr> </tbody> </table>	Fiber	Amplifier	FX-101□	FX-102□	FT-H30-M1V		450	1,600																																					
Fiber	Amplifier	FX-101□	FX-102□																																												
FT-H30-M1V		450	1,600																																												
Side-view lens for vacuum-resistant fiber	<b>FX-SV2</b>	 <p>Beam axis is bent by 90 °.</p> <ul style="list-style-type: none"> <li>Ambient temperature: -60 to +300 °C -140 to +572 °F</li> </ul>																																													
		<p><b>Sensing range (mm) [Lens on both sides] (Note 3)</b></p> <table border="1"> <thead> <tr> <th>Fiber</th> <th>Amplifier</th> <th>FX-101□</th> <th>FX-102□</th> </tr> </thead> <tbody> <tr> <td>FT-H30-M1V</td> <td></td> <td>450</td> <td>1,600</td> </tr> </tbody> </table>	Fiber	Amplifier	FX-101□	FX-102□	FT-H30-M1V		450	1,600																																					
Fiber	Amplifier	FX-101□	FX-102□																																												
FT-H30-M1V		450	1,600																																												

Notes: 1) Be careful when installing the thru-beam type fiber equipped with the expansion lens, as the beam envelope becomes narrow and alignment is difficult. Especially when installing a fiber with many cores (sharp bending fibers and heat-resistant glass fiber), please be sure to use it only after you have adjusted it sufficiently.  
 2) The fiber cable length practically limits the sensing range to 3,500 mm 137.795 in long (FT-H20W-M1, FT-P81X and FT-H20-M1: 1,600 mm 62.992 in).  
 3) The fiber cable length for the FT-H30-M1V is 1m 3.281 ft. The sensing ranges in FX-102□ (long sensing range type) take into account the length of the FT-J8 atmospheric side fiber.

### Lens (For reflective type fiber)

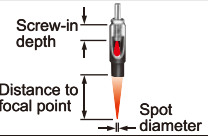
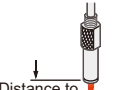
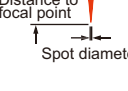
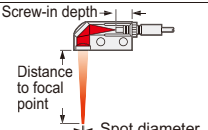
Designation	Model No.	Description												
For reflective type fiber	Pinpoint spot lens	<b>FX-MR1</b>	 <p>Pinpoint spot of <math>\phi 0.5</math> mm <math>\phi 0.020</math> in. Enables detection of minute objects or small marks.</p> <ul style="list-style-type: none"> <li>Distance to focal point: <math>6 \pm 1</math> mm <math>0.236 \pm 0.039</math> in</li> <li>Applicable fibers: <b>FD-WG4, FD-G4</b></li> <li>Ambient temperature: -40 to +70 °C -40 to +158 °F</li> </ul>											
	Zoom lens	<b>FX-MR2</b>	 <p>The spot diameter is adjustable from <math>\phi 0.7</math> mm to <math>\phi 2</math> mm <math>\phi 0.028</math> in to <math>\phi 0.079</math> in according to how much the fiber is screwed in.</p> <ul style="list-style-type: none"> <li>Applicable fibers: <b>FD-WG4, FD-G4</b></li> <li>Ambient temperature: -40 to +70 °C -40 to +158 °F</li> <li>Accessory: <b>MS-EX-3</b> (mounting bracket)</li> </ul>											
	Finest spot lens	<b>FX-MR3</b>	 <p>Extremely fine spot of <math>\phi 0.3</math> mm <math>\phi 0.012</math> in approx. achieved.</p> <ul style="list-style-type: none"> <li>Applicable fibers: <b>FD-WG4, FD-G4, FD-EG1, FD-EG2, FD-EG3, FD-G6X, FD-G6</b></li> <li>Ambient temperature: -40 to +70 °C -40 to +158 °F</li> </ul>											
	Finest spot lens	<b>FX-MR6</b>	 <p>Extremely fine spot of <math>\phi 0.1</math> mm <math>\phi 0.004</math> in approx. achieved.</p> <ul style="list-style-type: none"> <li>Applicable fibers: <b>FD-WG4, FD-G4, FD-EG1, FD-EG2, FD-EG3, FD-G6X, FD-G6</b></li> <li>Ambient temperature: -20 to +60 °C -4 to +140 °F</li> </ul>											
	Zoom lens (Side-view type)	<b>FX-MR5</b>	 <p>FX-MR2 is converted into a side-view type and can be mounted in a very small space.</p> <ul style="list-style-type: none"> <li>Applicable fibers: <b>FD-WG4, FD-G4</b></li> <li>Ambient temperature: -40 to +70 °C -40 to +158 °F</li> </ul>											
			<p><b>Sensing range for FX-101□ (Note)</b></p> <table border="1"> <thead> <tr> <th>Screw-in depth</th> <th>Distance to focal point</th> <th>Spot diameter</th> </tr> </thead> <tbody> <tr> <td>7 mm</td> <td>18.5 mm approx.</td> <td><math>\phi 0.7</math> mm</td> </tr> <tr> <td>12 mm</td> <td>27 mm approx.</td> <td><math>\phi 1.2</math> mm</td> </tr> <tr> <td>14 mm</td> <td>43 mm approx.</td> <td><math>\phi 2.0</math> mm</td> </tr> </tbody> </table>	Screw-in depth	Distance to focal point	Spot diameter	7 mm	18.5 mm approx.	$\phi 0.7$ mm	12 mm	27 mm approx.	$\phi 1.2$ mm	14 mm	43 mm approx.
Screw-in depth	Distance to focal point	Spot diameter												
7 mm	18.5 mm approx.	$\phi 0.7$ mm												
12 mm	27 mm approx.	$\phi 1.2$ mm												
14 mm	43 mm approx.	$\phi 2.0$ mm												

Note: The sensing ranges are the values when used in combination with FX-101□ (standard type). Please contact our office for details on sensing ranges for other types of amplifier.

**FIBER OPTIONS**

**Others**

Designation	Model No.	Description		
Protective tube (For thru-beam type fiber)	FTP-500 (0.5 m 1.640 ft)	For M4 thread	FT-B8 FT-P80 FT-FM2 FT-P60 FT-FM2S FT-FM2S4 FT-H13-FM2	
	FTP-1000 (1 m 3.281 ft)		Applicable fibers	
	FTP-1500 (1.5 m 4.921 ft)			The protective tube, made of non-corrosive stainless steel, protects the inner fiber cable from any external forces.
	FTP-N500 (0.5 m 1.640 ft)	For M3 thread		
	FTP-N1000 (1 m 3.281 ft)		For M4 thread	
	FTP-N1500 (1.5 m 4.921 ft)	FD-T80 FD-NFM2 FD-NFM2S FD-NFM2S4		
Protective tube (For reflective type fiber)	FDP-500 (0.5 m 1.640 ft)	For M6 thread	FD-B8 FD-P80 FD-FM2 FT-H13-FM2 FD-FM2S FD-FM2S4	
	FDP-1000 (1 m 3.281 ft)			For M4 thread
	FDP-1500 (1.5 m 4.921 ft)	FD-T80 FD-NFM2 FD-NFM2S FD-NFM2S4		
	FDP-N500 (0.5 m 1.640 ft)			
	FDP-N1000 (1 m 3.281 ft)			
	FDP-N1500 (1.5 m 4.921 ft)			
Fiber bender	FB-1	The fiber bender bends the sleeve part of the fiber head at the proper radius. (Note 1)		
Universal sensor mounting stand (Note 2)	MS-AJ1-F	Horizontal mounting type	Mounting stand assembly for fiber (For M3, M4 or M6 threaded head fiber)	
	MS-AJ2-F	Vertical mounting type		
Fiber cutter	FX-CT2	The free-cut type fiber can be easily cut. [Accessory. FX-CT1 is attached with the FT-P80 or the FD-P80. The FX-CT2 is provided with fibers other than this.]		
	FX-CT1			
Attachment for fixed-length fiber	FX-AT2	This is the attachment for the fixed length fiber. Orange. (Accessory)		
Attachment for $\phi 2.2$ mm $\phi 0.087$ in fiber	FX-AT3	This is the attachment for the $\phi 2.2$ mm $\phi 0.087$ in fiber. Clear Orange. (Accessory. Does not attach with the FT-P80 or the FD-P80.)		
Attachment for $\phi 1$ mm $\phi 0.039$ in fiber	FX-AT4	This is the attachment for the $\phi 1$ mm $\phi 0.039$ in fiber. Black. (Accessory)		
Attachment for $\phi 1.3$ mm $\phi 0.051$ in fiber	FX-AT5	This is the attachment for the $\phi 1.3$ mm $\phi 0.051$ in fiber. Gray. (Accessory)		
Attachment for $\phi 1$ mm $\phi 0.039$ in / $\phi 1.3$ mm $\phi 0.051$ in mixed fiber	FX-AT6	This is the attachment for the $\phi 1$ mm $\phi 0.039$ in / $\phi 1.3$ mm $\phi 0.051$ in mixed fiber. Black / Gray. (Accessory)		

Notes: 1) Do not bend the sleeve part of any side-view type fiber or ultra-small diameter head type fiber.  
2) Refer to the 'Sensor general catalog 2003-2004' or the SUNX website: <http://www.sunx.jp/> for universal sensor mounting stand.

**Fiber attachment**

It's possible to simultaneously cut two fibers to the same length

Each fiber (with some exceptions) has a newly developed two-in-one fiber attachment (FX-AT3/AT4/AT5/AT6) which enables two fibers to be cut simultaneously to the same length with the new fiber cutter (FX-CT2). Also, since the fibers can be attached to the amplifier while being fixed in position in the two-in-one fiber attachment, sensitivity changes resulting from variation in the amount of fiber insertion do not occur.

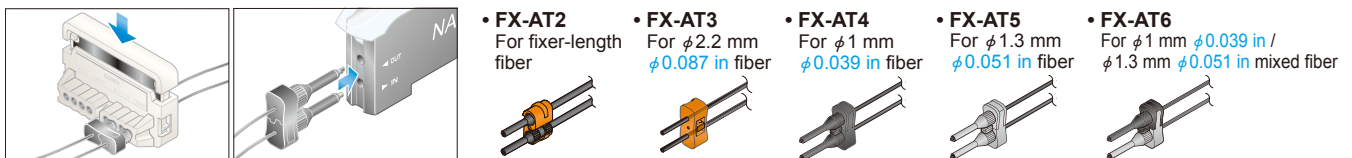

**PRECAUTIONS FOR PROPER USE**

- Never use this product as a sensing device for personnel protection.
- In case of using sensing devices for personnel protection, use products which meet regulations and standards, such as OSHA, ANSI or IEC etc., for personnel protection applicable in each region or country.

**Part description**

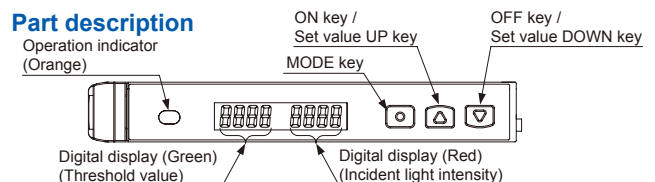

**Protective tube**

- FTP-□
- FDP-□

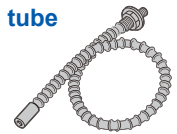

**Fiber bender**

- FB-1



**Fiber cutter**

- FX-CT2

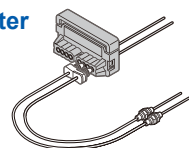

- FX-CT1



**Universal sensor mounting stand**

Using the arm which enables adjustment in the horizontal direction, sensing can also be done from above an assembly line.

- MS-AJ1-F

Forward / back adjustment: 130 mm  
5.118 in approx.

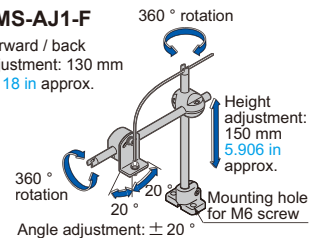

- MS-AJ2-F

Forward / back adjustment: 130 mm  
5.118 in approx.

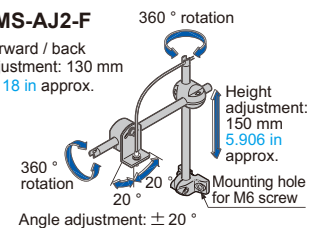

## DIMENSIONS (Unit: mm in)

The CAD data in the dimensions can be downloaded from the website: <http://www.sunx.jp/>

### FX-101□, FX-102□

Amplifier

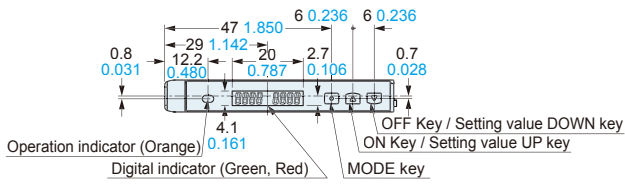

### Assembly dimensions with optional protective cover

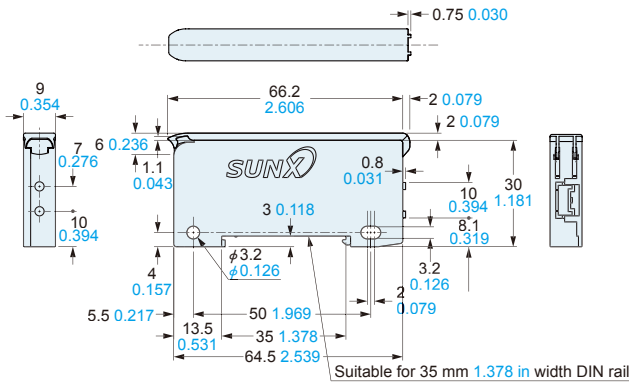

### FX-101(P)-Z, FX-102(P)-Z

Amplifier

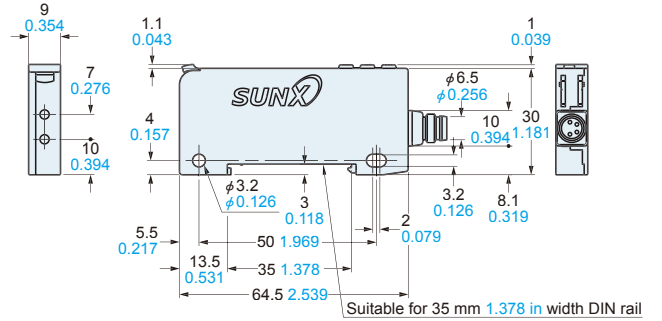
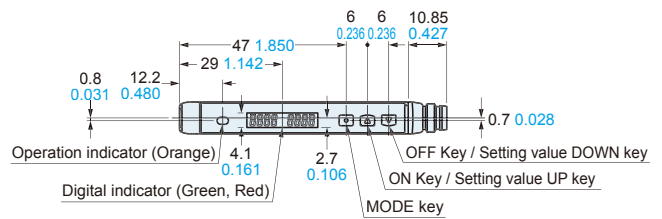

### MS-DIN-4

Amplifier mounting bracket (Optional)

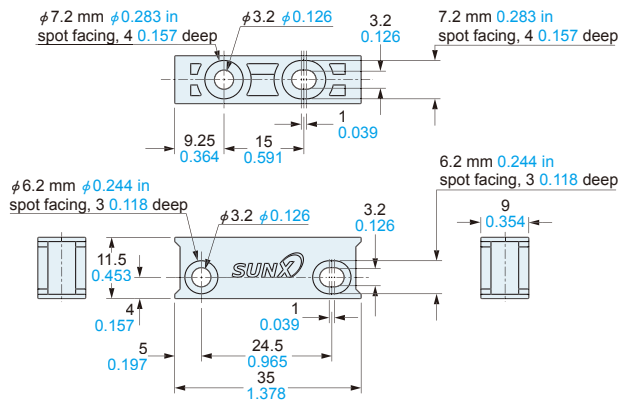

Material: PBT

### MS-DIN-E

End plate (Optional)

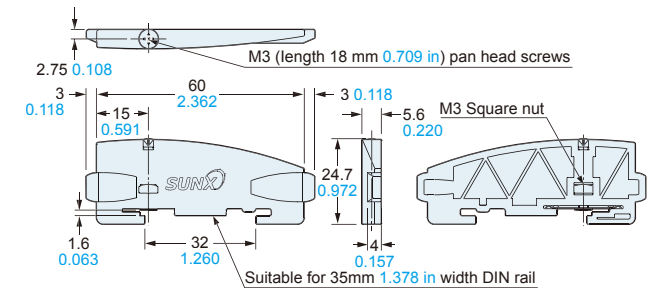

Material: Polycarbonate

### CN-14A-C□

Connector attached cable (Optional)

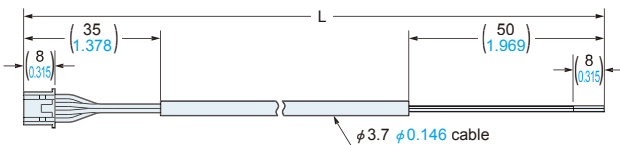

CN-14A-C2 is attached FX-101(P)-CC2 / FX-102(P)-CC2

• Length L

Model No.	Length L (mm in)
CN-14A-C1	1,000 39.370
CN-14A-C2	2,000 78.740
CN-14A-C3	3,000 118.110
CN-14A-C5	5,000 196.850

All information is subject to change without prior notice.



### SUNX Limited

2431-1 Ushiyama-cho, Kasugai-shi, Aichi,  
486-0901, Japan  
Phone: +81-(0)568-33-7211  
FAX: +81-(0)568-33-2631

### Overseas Sales Dept.

Phone: +81-(0)568-33-7861  
FAX: +81-(0)568-33-8591

<http://www.sunx.jp/>