

Frequency/Rate Meter K3MA-F

Highly Visible LCD Backlit Display with 2-Color (Red and Green) LEDs

- Wide input range - Contact, NPN, PNP, or voltage pulse.
- Front-panel key operation for easy setting.
- Average processing function suppresses flicker.
- Includes scaling, auto-zero time, startup compensation time functions.
- Easy confirmation of max/min display.
- Short 80-mm depth (measured from edge of face plate).
- Water- and dust-proof NEMA4X (IP66 equivalent) front panel.
- Finger protective cover (standard equipment) guards against electric shock.
- Recognized to U.S. and Canadian requirements under the Component Recognition Program of UL with CE marking.



Ordering Information

Stock Note: Shaded models are normally stocked.

Input type	Supply voltage	Output	Model
Pulse input (contact, open-collector or DC voltage)	100 to 240 VAC	None	K3MA-F 100-240VAC
		2 relay contact outputs (SPST-NO)	K3MA-F-A2 100-240VAC
	24 VAC/VDC	None	K3MA-F 24VAC/VDC
		2 relay contact outputs (SPST-NO)	K3MA-F-A2 24VAC/VDC

■ Accessories (Order Separately)

Stock Note: Shaded models are normally stocked.

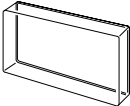
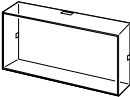
Name	Shape	Model
Splash-proof soft cover		K32-49SC
Hard cover		K32-49HC

Specifications

■ Ratings

Item	Model	
	K3MA-F 100-240VDC, K3MA-F-A2 100-240VAC	K3MA-F 24VAC/VDC, K3MA-F-A2 24VAC/VDC
Supply voltage	100 to 240 VAC	24 VAC/VDC
Operating voltage range	85% to 110% of the rated supply voltage	
Power consumption (under maximum load)	6 VA max.	4.5 VA max. (24 VAC) 4.5 W max. (24 VDC)
Insulation resistance	20 MΩ min. (at 500 VDC) between external terminal and case. Insulation provided between inputs, outputs, and power supply.	
Dielectric withstand voltage	2,000 VAC for 1 min between external terminal and case. Insulation provided between inputs, outputs, and power supply.	
Noise immunity	±1,500 V on power supply terminals in normal or common mode. ±1 μs, or 100 ns for square-wave noise with 1 ns.	±480 V on power supply terminals in normal mode. ±1,500 V in common mode. ±1 μs, or 100 ns for square-wave noise with 1 ns.
Vibration resistance	Vibration: 10 to 55 Hz, Acceleration: 50 m/s ² 5 min each in X, Y, and Z directions for 10 sweeps.	
Shock resistance	150 m/s ² (100 m/s ² for relay contact outputs) 3 times each on 3 axes, 6 directions.	
Ambient temperature	Operating: -10°C to 55°C (14°F to 131°F) with no condensation or icing Storage: -25°C to 65°C (-13°F to 149°F) with no condensation or icing	
Approved safety standards	UL3121, conforms to EN61010-1 (Pollution degree 2/overvoltage category II) Conforms to VDE0106/P100 (finger protection)	
EMC	(EMI) EN61326+A1 Industry Emission Enclosure: CISPR 11 Group 1 class A: CISRP16-1/-2 Emission AC Mains: CISPR 11 Group 1 class A: CISRP16-1/-2 (EMS) EN61326+A1 Industry Immunity ESD: EN61000-4-2: 4-kV contact discharge 8-kV air discharge Immunity RF-interference: EN61000-4-3: 10 V/m (amplitude-modulated, 80 MHz to 1 GHz) Electrical Fast Transient Noise: EN61000-4-4: 2 kV (power line) Immunity Burst Noise: 1 kV line to line (I/O signal line) Immunity Surge: EN61000-4-5: 1 kV (power line) 2-kV line to ground (power line) Immunity Conducted Disturbance: EN61000-4-6: 3 V (0.15 to 80 MHz) Immunity Voltage Dip/Interrupting: EN61000-4-11: 0.5 cycle, 0, 180°, 100% (rated voltage)	
Weight	Approx. 200 g	

Input/Output Ratings

Relay Contact Output

Item	Resistive load (cosφ = 1)	Inductive load (cosφ = 0.4, L/R = 7 ms)
Rated load	5 A at 250 VAC, 5 A at 30 VDC	1.5 A at 250 VAC, 1.5 A at 30 VDC
Rated carry current	5 A max. (at COM terminal)	
Max. contact voltage	250 VAC, 150 VDC	
Max. contact current	5 A (at COM terminal)	
Max. switching capacity	1,250 VA, 150 W	250 VA, 30 W
Min. permissible load (P level, reference value)	10 mA at 5 VDC	
Mechanical life	5,000,000 times min. (at a switching frequency of 1,200 times/min)	
Electrical life (at an ambient temperature of 20°C)	100,000 times min. (at a rated load switching frequency of 10 times/min)	

■ Measuring Ranges

No-voltage Contact/Open Collector Inputs

Input	Measuring range	Measuring accuracy	Displayable range
No-voltage contact (30 Hz max.) with ON/OFF pulse width of 15 ms min.	0.05 to 30.00 Hz	±0.1% FS ±1 digit max. (at 23±5°C)	-19999 to 99999 (with scaling function)
Open collector (5 kHz max.) with ON/OFF pulse width of 90 μs min.	0.05 to 5000.0 Hz		

■ Characteristics

Input signal	No-voltage contact (30 Hz max., ON/OFF pulse width: 15 ms min.) Voltage pulse (5 kHz max., ON/OFF pulse width: 90 μs min., ON voltage: 4.5 to 30 V/OFF voltage: 0 to 2 V) Open collector (5 kHz max., ON/OFF pulse width 90 μs min.) Connectable Sensors ON residual voltage: 2.5 V max. OFF leakage current: 0.1 mA max. Load current: Must have switching capacity of 15 mA min. Must be able to dependably switch a load current of 5 mA max.
Measuring accuracy	±0.1%FS ±1 digit (at 23±5°C)
Measurement method	Cycle measurement
Max. displayed digits	5 digits (-19999 to 99999)
Display	7-segment digital display, Character height: 14.2 mm
Polarity display	"-" is displayed automatically with a negative input signal.
Zero display	Leading zeros are not displayed.
Scaling function	Programmable with front-panel key inputs (range of display: -19999 to 99999). The decimal point position can be set as desired.
Hold function	Max hold (maximum value), Min hold (minimum value)
Hysteresis setting	Programmable with front-panel key inputs (0001 to 9999).
Other functions	Scaling teach function Display color change (green (red), green, red (green), red) OUT type change (upper limit, lower limit, upper/lower limit) Average processing (simple average OFF/2/4/8 operations) Auto-zero time Startup compensation time Setting change lockout Parameter initialization Display auto-return time
Output	Relays: 2 SPST-NO
Delay in comparative outputs	750 ms max.
Enclosure ratings	Front panel: NEMA4X for indoor use (equivalent to IP66) Rear case: IEC standard IP20 Terminals: IEC standard IP00 + finger protection (VDE0106/100)
Memory protection	Non-volatile memory (EEPROM) (possible to rewrite 100,000 times)

Nomenclature

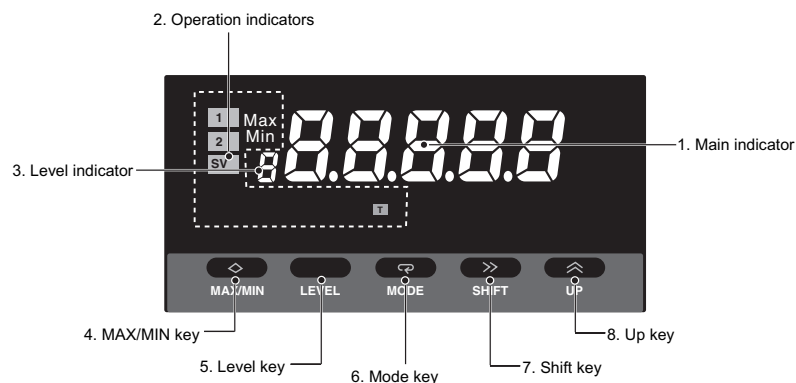

Name		Functions
1. Main indicator		Displays current values, parameters, and set values.
2. Operation indicators	1	Lit when output 1 is ON.
	2	Lit when output 2 is ON.
	SV	Lit when a set value is being displayed or changed.
	Max	Lit when the main indicator is showing the MAX value.
	Min	Lit when the main indicator is showing the MIN value.
	T	Lit when the teaching function is operable. Blinks while the teaching function is operating.
3. Level indicator		Displays the current level that the K3MA-F is in. (See below for details.)
4. MAX/MIN Key		Used to display the MAX and MIN values when a measurement value is being displayed.
5. Level Key		Used to change the level.
6. Mode Key		Used to allow the main indicator to indicate parameters sequentially.
7. Shift Key		Used to enable a set value to be changed. When changing a set value, this key is used to move along the digits.
8. Up Key		Used to change a set value. Used to set or clear a forced-zero function when a measurement value is being displayed.

Level indicator	Level
P	Protect
Not lit	Operation
S	Initial setting
F	Advanced-function setting

External Connections

Terminal Arrangement

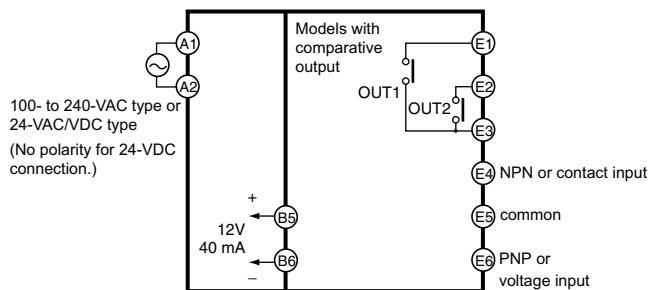
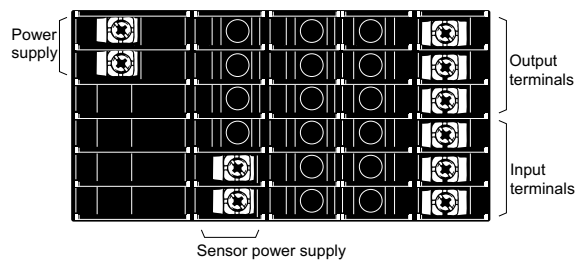

Note: Refer to *Input Circuits* below.

Terminal No.	Name	Description
A1 - A2	Operation power	Connects the operation power supply
E4, E6 - E5	Pulse input	No-voltage contact/open collector input
E1, E2 - E3	Outputs	Outputs the relay outputs
B5 - B6	Sensor power supply	Use as the power supply for sensors

Dimensions

Unit: mm (inch)

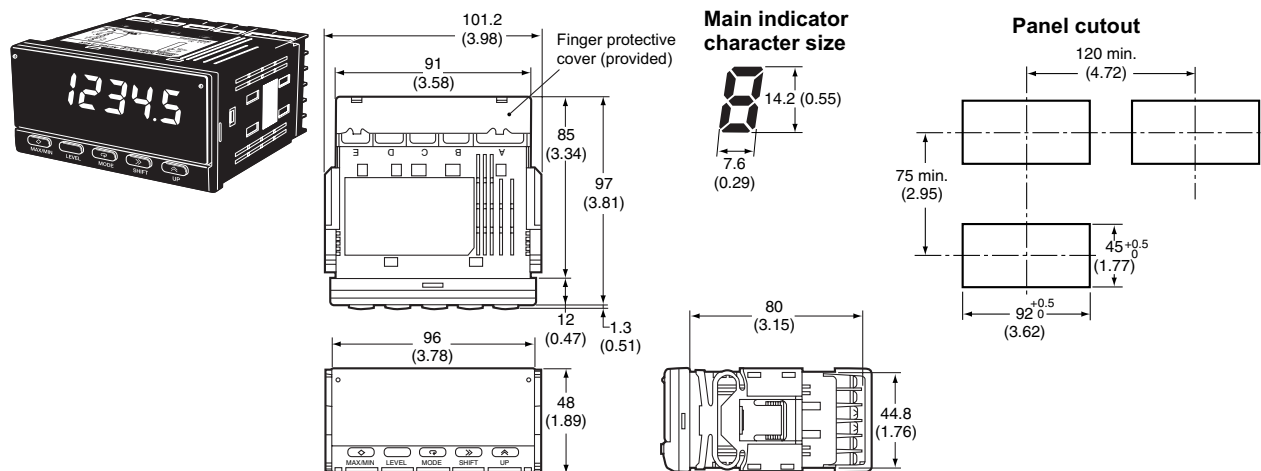

Installation

1. Insert the K3MA-F into the panel cutout hole.
2. For a waterproof installation, insert the rubber gasket onto the body of the K3MA-F.

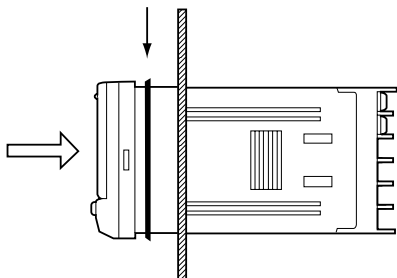

3. Fit the adapter into the grooves on the left and right sides of the rear case, then push it until it contacts the panel to secure the K3MA-F.

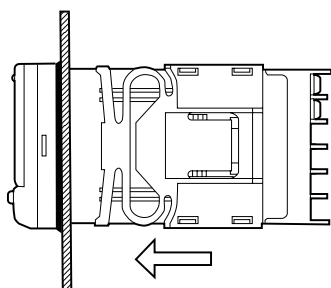

■ Wiring Precautions

- Use crimp terminals.
- Tighten the terminal screws to a torque of approximately 0.5 N-m.
- To avoid the influence of noise, route signal lines and power lines separately.

■ Wiring

- Use the following M3 crimp terminals.

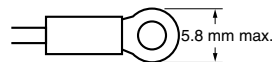

■ Unit Markings (Provided)

- The unit markings are not attached to the K3MA-F. Select the desired markings from the provided sheet.

V	A	V	A	%	J	Pa	Ω
s	/	N	m	W	°C	m ³	k
°F	g	min	mm	rpm			
VA	mV	mA	Hz				
m/min	OMRON						
OUT	OUT						

Note: For scales and gauges, use the unit markings that are specified by the relevant laws or regulations.

Precautions

⚠ Caution
Do not touch the terminals while the power is being supplied. Doing so may result in electric shock.

⚠ Caution
Do not disassemble the product or touch the internal components of the product while the power is being supplied. Doing so may result in electric shock.

⚠ Caution
Do not allow pieces of metal or wire clippings to enter the product. Doing so may result in electric shock, fire, or malfunction.

⚠ Caution
Perform correct settings for the product according to the control application. Failure to do so may cause unexpected operation, resulting in damage to the product or injury.

⚠ Caution
Take safety measures, such as installing a separate monitoring system, to ensure safety even if the product fails. Product failure may prevent comparative outputs from being generated, resulting in serious accidents.

Observe the following precautions to ensure safety.

- Maintain the power supply voltage within the range specified in the specifications.
- Maintain the load within the ratings specified in the specifications.
- Check each terminal for correct number and polarity before connecting it. Incorrect or reverse connections may damage or burn out internal components in the product.
- Tighten the terminal screws securely. The recommended tightening torque is 0.43 to 0.58 N·m. Loose screws may cause fire or malfunction.
- Do not connect anything to unused terminals.
- Provide a switch or circuit breaker so that operators can easily turn OFF the power supply when necessary. Also provide appropriate indications of such devices.
- Do not attempt to disassemble, repair, or modify the product.
- Do not use the product where flammable or combustible gases are present.

Application

General Precautions

- Do not use the product in the following locations:
 - Locations subject to direct radiant heat from heating equipment.
 - Locations subject to exposure to water, oil, or chemicals.
 - Locations subject to direct sunlight.
 - Locations subject to dust or corrosive gases (particularly sulfuric gas or ammonia gas).
 - Locations subject to severe changes in temperature.
 - Locations subject to icing or condensation.
 - Locations subject to shock or vibration.
- Do not block heat dissipation around the product, i.e., provide sufficient space for heat dissipation.
- Ensure that the rated voltage is reached within two seconds after the power is turned ON.
- Conduct aging for 15 minutes min. after power is turned ON for correct measurement.

- Do not touch the slit sections or terminals while the power is being supplied to prevent the product from being affected by static electricity.
- Do not lay heavy objects on the product during use or storage. Doing so may deform or deteriorate the product.
- Do not use paint thinner for cleaning. Use commercially available alcohol.

Mounting

- Mount the product to a panel that is 1 to 8 mm thick.
- Install the product in a horizontal position.
- Use crimp terminals that match screw sizes.

Noise Prevention

- Install the product as far as possible from devices that generate strong, high-frequency fields (such as high-frequency welders or sewing machines) or surges.
- Install surge absorbers or noise filters on nearby devices that generate noise (particularly motors, transformers, solenoids, magnet coils, and other devices that have a high inductance component).

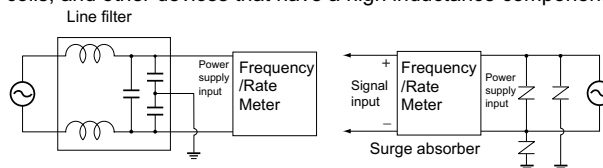

- To prevent inductive noise, separate the terminal block wiring for the product from high-voltage or high-current power lines. Do not route the wiring for the product in parallel with or tie it in a bundle with power lines.
- When using a noise filter for the power supply, check for the voltage and current and install it as close as possible to the Frequency/Rate Meter.
- Do not install the product near radios, television sets, or wireless devices. Doing so may cause reception interference.

Increasing Service Life

- Do not use the product in locations where the temperature or humidity exceeds the ratings or where condensation may occur. When installing the product in a panel, be sure that the temperature around the product (not the temperature around the panel) does not exceed the ratings. The product service life depends on the ambient temperature. The higher the ambient temperature, the shorter the service life. To extend the product service life, lower the temperature inside the Frequency/Rate Meter.
- Use and store the product within the temperature and humidity ranges given in the specifications. When gang-mounting Frequency/Rate Meters or arranging them vertically, heat generated by the Frequency/Rate Meters will cause the internal temperature to rise, reducing the service life. In such cases, consider forced cooling methods, such as using a fan to circulate air around the Frequency/Rate Meters. Do not, however, allow only the terminals to be cooled. Doing so will increase measurement error.
- The life of the output relays is greatly affected by the switching capacity and switching conditions. Use these relays within their rated load and electrical life. The contacts may fuse or burn if they are used past their electrical life.

Certain Terms and Conditions of Sale

1. **Offer; Acceptance.** These terms and conditions (these "Terms") are deemed part of all catalogs, manuals or other documents, whether electronic or in writing, relating to the sale of goods or services (collectively, the "Goods") by Omron Electronics LLC and its subsidiary companies ("Seller"). Seller hereby objects to any terms or conditions proposed in Buyer's purchase order or other documents which are inconsistent with, or in addition to, these Terms. Please contact your Omron representative to confirm any additional terms for sales from your Omron company.
2. **Prices.** All prices stated are current, subject to change without notice by Seller. Buyer agrees to pay the price in effect at time of shipment.
3. **Discounts.** Cash discounts, if any, will apply only on the net amount of invoices sent to Buyer after deducting transportation charges, taxes and duties, and will be allowed only if (i) the invoice is paid according to Seller's payment terms and (ii) Buyer has no past due amounts owing to Seller.
4. **Orders.** Seller will accept no order less than \$200 net billing.
5. **Governmental Approvals.** Buyer shall be responsible for, and shall bear all costs involved in, obtaining any government approvals required for the importation or sale of the Goods.
6. **Taxes.** All taxes, duties and other governmental charges (other than general real property and income taxes), including any interest or penalties thereon, imposed directly or indirectly on Seller or required to be collected directly or indirectly by Seller for the manufacture, production, sale, delivery, importation, consumption or use of the Goods sold hereunder (including customs duties and sales, excise, use, turnover and license taxes) shall be charged to and remitted by Buyer to Seller.
7. **Financial.** If the financial position of Buyer at any time becomes unsatisfactory to Seller, Seller reserves the right to stop shipments or require satisfactory security or payment in advance. If Buyer fails to make payment or otherwise comply with these Terms or any related agreement, Seller may (without liability and in addition to other remedies) cancel any unshipped portion of Goods sold hereunder and stop any Goods in transit until Buyer pays all amounts, including amounts payable hereunder, whether or not then due, which are owing to it by Buyer. Buyer shall in any event remain liable for all unpaid accounts.
8. **Cancellation; Etc.** Orders are not subject to rescheduling or cancellation unless Buyer indemnifies Seller fully against all costs or expenses arising in connection therewith.
9. **Force Majeure.** Seller shall not be liable for any delay or failure in delivery resulting from causes beyond its control, including earthquakes, fires, floods, strikes or other labor disputes, shortage of labor or materials, accidents to machinery, acts of sabotage, riots, delay in or lack of transportation or the requirements of any government authority.
10. **Shipping; Delivery.** Unless otherwise expressly agreed in writing by Seller:
 - a. Shipments shall be by a carrier selected by Seller;
 - b. Such carrier shall act as the agent of Buyer and delivery to such carrier shall constitute delivery to Buyer;
 - c. All sales and shipments of Goods shall be FOB shipping point (unless otherwise stated in writing by Seller), at which point title to and all risk of loss of the Goods shall pass from Seller to Buyer, provided that Seller shall retain a security interest in the Goods until the full purchase price is paid by Buyer;
 - d. Delivery and shipping dates are estimates only.
 - e. Seller will package Goods as it deems proper for protection against normal handling and extra charges apply to special conditions.
11. **Claims.** Any claim by Buyer against Seller for shortage or damage to the Goods occurring before delivery to the carrier must be presented in writing to Seller within 30 days of receipt of shipment and include the original transportation bill signed by the carrier noting that the carrier received the Goods from Seller in the condition claimed.
12. **Warranties.** (a) **Exclusive Warranty.** Seller's exclusive warranty is that the Goods will be free from defects in materials and workmanship for a period of twelve months from the date of sale by Seller (or such other period expressed in writing by Seller). Seller disclaims all other warranties, express or implied. (b) **Limitations.** SELLER MAKES NO WARRANTY OR REPRESENTATION, EXPRESS OR IMPLIED, ABOUT NON-INFRINGEMENT, MERCHANTABILITY OR FITNESS FOR A PARTICULAR PURPOSE OF THE GOODS. BUYER ACKNOWLEDGES THAT IT ALONE HAS DETERMINED THAT THE GOODS WILL SUITABLY MEET THE REQUIREMENTS OF THEIR INTENDED USE. Seller further disclaims all warranties and responsibility of any type for claims or expenses based on infringement by the Goods or otherwise of any intellectual property right. (c) **Buyer Remedy.** Seller's sole obligation hereunder shall be to replace (in the form originally shipped with Buyer responsible for labor charges for removal or replacement thereof) the non-complying Good or, at Seller's election, to repay or credit Buyer an amount equal to the purchase price of the Good; provided that in no event shall Seller be responsible for warranty, repair, indemnity or any other claims or expenses regarding the Goods unless Seller's analysis confirms that the Goods were properly handled, stored, installed and maintained and not subject to contamination, abuse, misuse or inappropriate modification. Return of any goods by Buyer must be approved in writing by Seller before shipment. Seller shall not be liable for the suitability or unsuitability or the results from the use of Goods in combination with any electrical or electronic components, circuits, system assemblies or any other materials or substances or environments. Any advice, recommendations or information given orally or in writing, are not to be construed as an amendment or addition to the above warranty.
13. **Damage Limits; Etc.** SELLER SHALL NOT BE LIABLE FOR SPECIAL, INDIRECT OR CONSEQUENTIAL DAMAGES, LOSS OF PROFITS OR PRODUCTION OR COMMERCIAL LOSS IN ANY WAY CONNECTED WITH THE GOODS, WHETHER SUCH CLAIM IS BASED IN CONTRACT, WARRANTY, NEGLIGENCE OR STRICT LIABILITY. Further, in no event shall liability of Seller exceed the individual price of the Good on which liability is asserted.
14. **Indemnities.** Buyer shall indemnify and hold harmless Seller, its affiliates and its employees from and against all liabilities, losses, claims, costs and expenses (including attorney's fees and expenses) related to any claim, investigation, litigation or proceeding (whether or not Seller is a party) which arises or is alleged to arise from Buyer's acts or omissions under these Terms or in any way with respect to the Goods. Without limiting the foregoing, Buyer (at its own expense) shall indemnify and hold harmless Seller and defend or settle any action brought against Seller to the extent that it is based on a claim that any Good made to Buyer specifications infringed intellectual property rights of another party.
15. **Property; Confidentiality.** The intellectual property embodied in the Goods is the exclusive property of Seller and its affiliates and Buyer shall not attempt to duplicate it in any way without the written permission of Seller. Notwithstanding any charges to Buyer for engineering or tooling, all engineering and tooling shall remain the exclusive property of Seller. All information and materials supplied by Seller to Buyer relating to the Goods are confidential and proprietary, and Buyer shall limit distribution thereof to its trusted employees and strictly prevent disclosure to any third party.
16. **Miscellaneous.** (a) **Waiver.** No failure or delay by Seller in exercising any right and no course of dealing between Buyer and Seller shall operate as a waiver of rights by Seller. (b) **Assignment.** Buyer may not assign its rights hereunder without Seller's written consent. (c) **Amendment.** These Terms constitute the entire agreement between Buyer and Seller relating to the Goods, and no provision may be changed or waived unless in writing signed by the parties. (d) **Severability.** If any provision hereof is rendered ineffective or invalid, such provision shall not invalidate any other provision. (e) **Setoff.** Buyer shall have no right to set off any amounts against the amount owing in respect of this invoice. (f) As used herein, "including" means "including without limitation".

Certain Precautions on Specifications and Use

1. **Suitability of Use.** Seller shall not be responsible for conformity with any standards, codes or regulations which apply to the combination of the Good in the Buyer's application or use of the Good. At Buyer's request, Seller will provide applicable third party certification documents identifying ratings and limitations of use which apply to the Good. This information by itself is not sufficient for a complete determination of the suitability of the Good in combination with the end product, machine, system, or other application or use. The following are some examples of applications for which particular attention must be given. This is not intended to be an exhaustive list of all possible uses of this Good, nor is it intended to imply that the uses listed may be suitable for this Good:
 - (i) Outdoor use, uses involving potential chemical contamination or electrical interference, or conditions or uses not described in this document.
 - (ii) Energy control systems, combustion systems, railroad systems, aviation systems, medical equipment, amusement machines, vehicles, safety equipment, and installations subject to separate industry or government regulations.
 - (iii) Systems, machines and equipment that could present a risk to life or property. Please know and observe all prohibitions of use applicable to this Good.
2. **Programmable Products.** Seller shall not be responsible for the user's programming of a programmable Good, or any consequence thereof.
3. **Performance Data.** Performance data given in this catalog is provided as a guide for the user in determining suitability and does not constitute a warranty. It may represent the result of Seller's test conditions, and the user must correlate it to actual application requirements. Actual performance is subject to the Seller's Warranty and Limitations of Liability.
4. **Change in Specifications.** Product specifications and accessories may be changed at any time based on improvements and other reasons. It is our practice to change part numbers when published ratings or features are changed, or when significant construction changes are made. However, some specifications of the Good may be changed without any notice. When in doubt, special part numbers may be assigned to fix or establish key specifications for your application. Please consult with your Seller's representative at any time to confirm actual specifications of purchased Good.
5. **Errors and Omissions.** The information in this catalog has been carefully checked and is believed to be accurate; however, no responsibility is assumed for clerical, typographical or proofreading errors, or omissions.

NEVER USE THE PRODUCT FOR AN APPLICATION INVOLVING SERIOUS RISK TO LIFE OR PROPERTY WITHOUT ENSURING THAT THE SYSTEM AS A WHOLE HAS BEEN DESIGNED TO ADDRESS THE RISKS, AND THAT THE SELLER'S PRODUCT IS PROPERLY RATED AND INSTALLED FOR THE INTENDED USE WITHIN THE OVERALL EQUIPMENT OR SYSTEM.

Complete “Terms and Conditions of Sale” for product purchase and use are on Omron’s website at www.omron.com/oei – under the “About Us” tab, in the Legal Matters section.

ALL DIMENSIONS SHOWN ARE IN MILLIMETERS.

To convert millimeters into inches, multiply by 0.03937. To convert grams into ounces, multiply by 0.03527.

OMRON[®]**OMRON ELECTRONICS LLC**

One Commerce Drive
Schaumburg, IL 60173

847-843-7900

For US technical support or other inquiries:

800-556-6766**OMRON CANADA, INC.**

885 Milner Avenue
Toronto, Ontario M1B 5V8

416-286-6465**OMRON ON-LINE**

Global - <http://www.omron.com>
USA - <http://www.omron.com/oei>
Canada - <http://www.omron.ca>