

Data Sheet



Description

The ACPL-P480 fast speed optocoupler contains a GaAsP LED and photo detector with built-in Schmitt trigger to provide logic-compatible waveforms, eliminating the need for additional wave shaping. The totem pole output eliminates the need for a pull up resistor and allows for direct drive Intelligent Power Module or gate drive. Minimized propagation delay difference between devices make these optocouplers excellent solutions for improving inverter efficiency through reduced switching dead time.

Functional Diagram

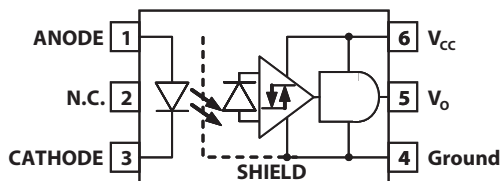

Note: A 0.1 μ F bypass capacitor must be connected between pins 4 and 6.

Truth Table (Positive Logic)

LED	VO
ON	HIGH
OFF	LOW

Features

- Performance Specified for Common IPM Applications Over Industrial Temperature Range.
- Short Maximum Propagation Delays
- Minimized Pulse Width Distortion (PWD)
- Very High Common Mode Rejection (CMR)
- Hysteresis
- Totem Pole Output (No Pull-up Resistor Required)
- Available in Stretched SO-6 package.
- Safety Approval:

UL Recognized with 3750 V_{rms} for 1 minute (5000 V_{rms} for 1 minute for Option 020 device) per UL1577.

CSA Approved.

IEC/EN/DIN EN 60747-5-2 Approved with $V_{IORM} = 891 V_{peak}$ for option 060.

Specifications

- Wide operating temperature range: $-40^{\circ}C$ to $100^{\circ}C$.
- Maximum propagation delay $t_{PHL} / t_{PLH} = 350$ ns
- Maximum Pulse Width Distortion (PWD) = 250 ns.
- Propagation Delay Difference: Min. -100 ns, Max. 250 ns
- Wide Operating V_{CC} Range: 4.5 to 20 Volts
- 20 $kV/\mu s$ minimum common mode rejection (CMR) at $V_{CM} = 1000$ V.

Applications

- IPM Interface Isolation
- Isolated IGBT/MOSFET Gate Drive
- AC and Brushless DC Motor Drives
- Industrial Inverters
- General Digital Isolation

CAUTION: It is advised that normal static precautions be taken in handling and assembly of this component to prevent damage and/or degradation which may be induced by ESD.

Recommended Solder Reflow Temperature Profile

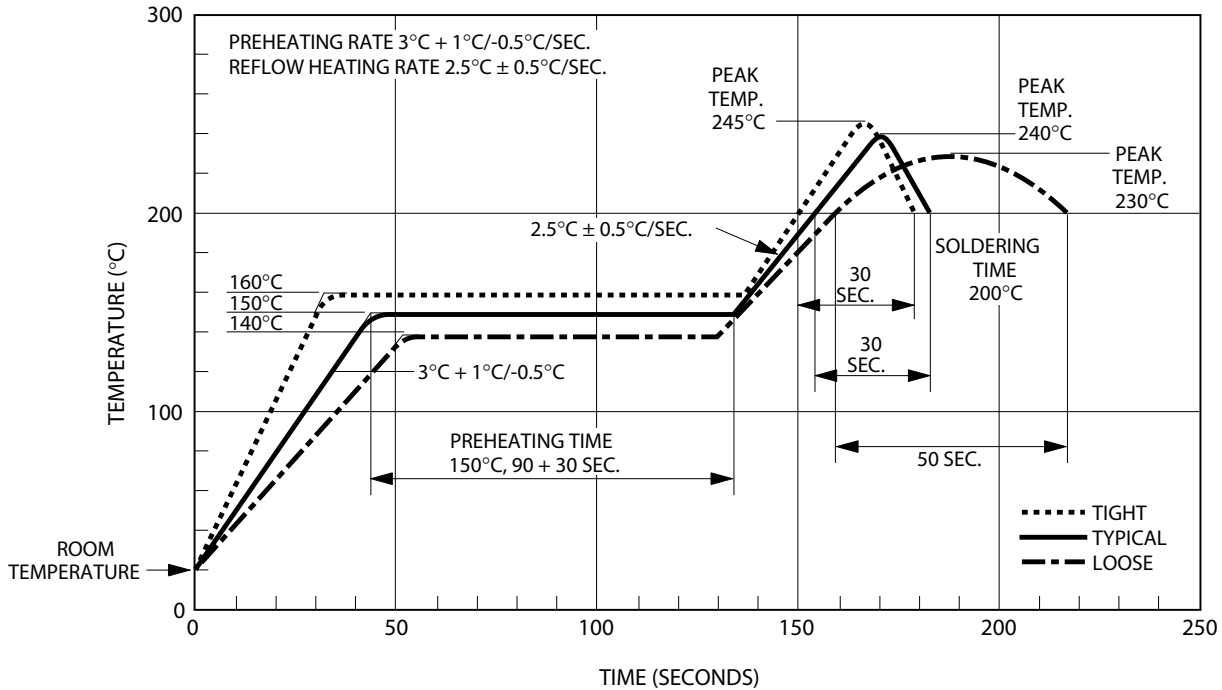

Note: Non-halide flux should be used.

Recommended Pb-Free IR Profile

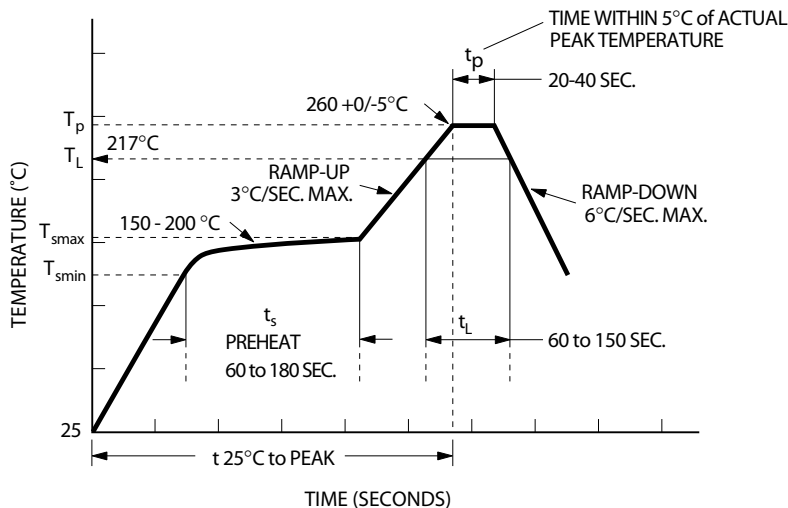

NOTES:
 THE TIME FROM 25°C TO PEAK TEMPERATURE = 8 MINUTES MAX.
 $T_{\text{smax}} = 200^{\circ}\text{C}, T_{\text{smin}} = 150^{\circ}\text{C}$

Note: Non-halide flux should be used.

Regulatory Information

The ACPL-P480 is approved by the following organizations:

IEC/EN/DIN EN 60747-5-2 (Option 060 only)

Approval under:
 IEC 60747-5-2:1997 + A1:2002
 EN 60747-5-2:2001 + A1:2002
 DIN EN 60747-5-2 (VDE 0884 Teil 2):2003-01

UL

Approval under UL 1577, component recognition program up to $V_{\text{ISO}} = 3750 \text{ V}_{\text{RMS}}$. File E55361.

CSA

Approval under CSA Component Acceptance Notice #5, File CA 88324.

Table 1. IEC/EN/DIN EN 60747-5-2 Insulation Characteristics* (ACPL-P480 Option 060)

Description	Symbol	Characteristic	Unit
Installation classification per DIN VDE 0110/1.89, Table 1 for rated mains voltage $\leq 150 V_{rms}$ for rated mains voltage $\leq 300 V_{rms}$ for rated mains voltage $\leq 450 V_{rms}$ for rated mains voltage $\leq 600 V_{rms}$		I – IV I – IIV I – III I – III	
Climatic Classification		55/100/21	
Pollution Degree (DIN VDE 0110/1.89)		2	
Maximum Working Insulation Voltage	V_{IORM}	891	V_{peak}
Input to Output Test Voltage, Method b* $V_{IORM} \times 1.875 = V_{PR}$, 100% Production Test with $t_m = 1$ sec, Partial discharge < 5 pC	V_{PR}	1670	V_{peak}
Input to Output Test Voltage, Method a* $V_{IORM} \times 1.5 = V_{PR}$, Type and Sample Test, $t_m = 60$ sec, Partial discharge < 5 pC	V_{PR}	1336	V_{peak}
Highest Allowable Overvoltage (Transient Overvoltage $t_{ini} = 10$ sec)	V_{IOTM}	6000	V_{peak}
Safety-limiting values – maximum values allowed in the event of a failure.			
Case Temperature	T_S	175	$^{\circ}C$
Input Current	$I_{S, INPUT}$	230	mA
Output Power	$P_{S, OUTPUT}$	600	mW
Insulation Resistance at T_S , $V_{IO} = 500$ V	R_S	> 109	Ω

* Refer to the optocoupler section of the Isolation and Control Components Designer's Catalog, under Product Safety Regulations section, (IEC/EN/ DIN EN 60747-5-2) for a detailed description of Method a and Method b partial discharge test profiles.

Table 2. Insulation and Safety Related Specifications

Parameter	Symbol	ACPL-P480	Units	Conditions
Minimum External Air Gap (External Clearance)	L(101)	7.0	mm	Measured from input terminals to output terminals, shortest distance through air.
Minimum External Tracking (External Creepage)	L(102)	8.0	mm	Measured from input terminals to output terminals, shortest distance path along body.
Minimum Internal Plastic Gap (Internal Clearance)		0.08	mm	Through insulation distance conductor to conductor, usually the straight line distance thickness between the emitter and detector.
Minimum Internal Tracking (Internal Creepage)		NA	mm	Measured from input terminals to output terminals, along internal cavity.
Tracking Resistance (Comparative Tracking Index)	CTI	> 175	V	DIN IEC 112/VDE 0303 Part 1
Isolation Group		IIIa		Material Group (DIN VDE 0110, 1/89, Table 1)

Table 3. Absolute Maximum Ratings

Parameter	Symbol	Min.	Max.	Units	Note
Storage Temperature	T _S	-55	125	°C	
Operating Temperature	T _A	-40	100	°C	
Average Input Current	I _{F(avg)}		10	mA	
Peak Transient Input Current (<1 μs pulse width, 300 pps) (<200 μs pulse width, < 1% duty cycle)	I _{F(tran)}		1.0 40	A mA	
Reverse Input Voltage	V _R		5	V	
Average Output Current	I _O		25	mA	
Supply Voltage	V _{CC}	0	25		
Output Voltage	V _O	-0.5	25		
Total Package Power Dissipation	P _T		210	mW	1
Solder Reflow Temperature Profile	See Reflow Thermal Profile.				

Table 4. Recommended Operating Conditions

Parameter	Symbol	Min.	Max.	Units	Note
Power Supply Voltage	V _{CC}	4.5	20	V	
Forward Input Current (ON)	I _{F(ON)}	6	10	mA	
Forward Input Voltage (OFF)	V _{F(OFF)}	-	0.8	V	
Operating Temperature	T _A	-40	100	°C	

Table 5. Electrical Specifications

Over recommended operating conditions T_A = -40 °C to 100 °C, V_{CC} = +4.5 V to 20 V, I_{F(ON)} = 6 mA to 10 mA, V_{F(OFF)} = 0 V to 0.8 V, unless otherwise specified. All typicals at T_A = 25 °C.

Parameter	Symbol	Min.	Typ.	Max.	Units	Test Conditions	Fig.	Note
Logic Low Output Voltage	V _{OL}			0.5	V	I _{OL} = 6.4 mA	1, 3	
Logic High Output Voltage	V _{OH}	2.4	V _{CC} - 1.1		V	I _{OH} = -2.6 mA	2, 3,	
		2.7				I _{OH} = -0.4 mA	7	
Output Leakage Current (V _O = V _{CC} +0.5V)	I _{OHH}			100	μA	V _{CC} = 5 V, I _F = 10mA		
				500	μA	V _{CC} = 20 V, I _F = 10mA		
Logic Low Supply Current	I _{CCL}		1.9	3.0	mA	V _{CC} = 5.5 V, V _F = 0 V, I _O = Open		
			2.0	3.0	mA	V _{CC} = 20 V, V _F = 0 V, I _O = Open		
Logic High Supply Current	I _{CCH}		1.5	2.5	mA	V _{CC} = 5.5 V, I _F = 10 mA, I _O = Open		
			1.6	2.5	mA	V _{CC} = 20 V, I _F = 10 mA I _O = Open		
Logic Low Short Circuit Output Current	I _{OSL}	25			mA	V _O = V _{CC} = 5.5 V, V _F =0V		2
		50			mA	V _O = V _{CC} = 20 V, V _F =0V		
Logic High Short Circuit Output Current	I _{OSH}			-25	mA	V _{CC} = 5.5 V, I _F =6mA, V _O =GND		2
				-50	mA	V _{CC} = 20 V, I _F =6mA, V _O =GND		
Input Forward Voltage	V _F		1.5	1.7	V	T _A = 25°C, I _F =6mA	4	
				1.85	V	I _F =6mA		
Input Reverse Breakdown Voltage	BV _R	5			V	I _R = 10 μA		
Input Diode Temperature Coefficient	ΔV _F /ΔT _A		1.7		mV/°C	I _F = 6 mA		
Input Capacitance	C _{IN}		60		pF	f = 1 MHz, V _F = 0 V		3

Table 6. Switching Specifications

Over recommended operating conditions $T_A = -40\text{ }^\circ\text{C}$ to $100\text{ }^\circ\text{C}$, $V_{CC} = +4.5\text{ V}$ to 20 V , $I_{F(ON)} = 6\text{ mA}$ to 10 mA , $V_{F(OFF)} = 0\text{ V}$ to 0.8 V , unless otherwise specified. All typicals at $T_A = 25\text{ }^\circ\text{C}$.

Parameter	Symbol	Min.	Typ.	Max.	Units	Test Conditions	Fig.	Note
Propagation Delay Time to Logic Low Output Level	t_{PHL}		150	350	ns	With Peaking Capacitor	5, 6	5
Propagation Delay Time to Logic High Output Level	t_{PLH}		110	350	ns	With Peaking Capacitor	5, 6	5
Pulse Width Distortion	$ t_{PHL} - t_{PLH} = \text{PWD}$			250	ns			8
Propagation Delay Difference Between Any 2 Parts	PDD	-100		250	ns			10
Output Rise Time (10-90%)	t_r		16		ns		5, 8	
Output Fall Time (90-10%)	t_f		20		ns		5, 8	
Logic High Common Mode Transient Immunity	$ CM_H $	20			kV/ μs	$ V_{CM} = 1000\text{ V}$, $I_F = 6.0\text{ mA}$, $V_{CC} = 5\text{ V}$, $T_A = 25\text{ }^\circ\text{C}$	9	6
Logic Low Common Mode Transient Immunity	$ CM_L $	20			kV/ μs	$ V_{CM} = 1000\text{ V}$, $V_F = 0\text{ V}$, $V_{CC} = 5\text{ V}$, $T_A = 25\text{ }^\circ\text{C}$	9	6

Table 7. Package Characteristics

Parameter	Symbol	Min.	Typ.	Max.	Units	Test Conditions	Fig.	Note
Input-Output Momentary Withstand Voltage*	V_{ISO}	3750			V_{rms}	$RH < 50\%$, $t = 1\text{ min.}$, $T_A = 25\text{ }^\circ\text{C}$		4, 7
		5000 (For Option 020)						
Input-Output Resistance	R_{I-O}		10^{12}			$V_{I-O} = 500\text{ Vdc}$		4
Input-Output Capacitance	C_{I-O}		0.6			$f = 1\text{ MHz}$, $V_{I-O} = 0\text{ Vdc}$		4

* The Input-Output Momentary Withstand Voltage is a dielectric voltage rating that should not be interpreted as an input-output continuous voltage rating. For the continuous voltage rating refer to the IEC/EN/DIN EN 60747-5-2 Insulation Characteristics Table (if applicable).

Notes:

- Derate total package power dissipation, P_T , linearly above $70\text{ }^\circ\text{C}$ free-air temperature at a rate of $4.5\text{ mW}/^\circ\text{C}$.
- Duration of output short circuit time should not exceed 10 ms.
- Input capacitance is measured between pin 1 and pin 3.
- Device considered a two-terminal device: pins 1, 2 and 3 shorted together and pins 4, 5 and 6 shorted together.
- The t_{PLH} propagation delay is measured from the 50% point on the leading edge of the input pulse to the 1.3 V point on the leading edge of the output pulse. The t_{PHL} propagation delay is measured from the 50% point on the trailing edge of the input pulse to the 1.3 V point on the trailing edge of the output pulse.
- CM_H is the maximum slew rate of the common mode voltage that can be sustained with the output voltage in the logic high state, $V_O > 2.0\text{ V}$. CM_L is the maximum slew rate of the common mode voltage that can be sustained with the output voltage in the logic low state, $V_O < 0.8\text{ V}$.
- In accordance with UL 1577, each optocoupler is proof tested by applying an insulation test voltage $\geq 4500\text{ V}_{RMS}$ for one second (leakage detection current limit, $I_{I-O} \leq 5\text{ }\mu\text{A}$). ; each optocoupler with option 020 is proof tested by applying an insulation test voltage $\geq 6000\text{ V}_{RMS}$ for 1 second (leakage detection current limit, $I_{I-O} \leq 5\text{ }\mu\text{A}$). This test is performed before the 100% production test for partial discharge (Method b) shown in the IEC/EN/DIN EN 60747-5-2 Insulation Characteristics Table, if applicable.
- Pulse Width Distortion (PWD) is defined as $|t_{PHL} - t_{PLH}|$ for any given device.
- Use of a $0.1\text{ }\mu\text{F}$ bypass capacitor connected between pins 4 and 6 is recommended.
- The difference between t_{PLH} and t_{PHL} between any two devices under the same test condition.

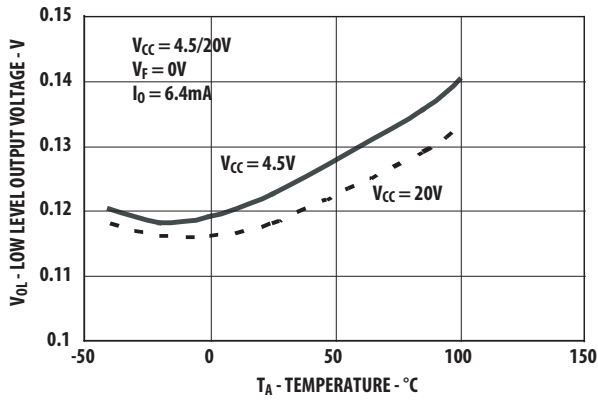

Figure 1. Typical Logic Low Output Voltage vs. Temperature

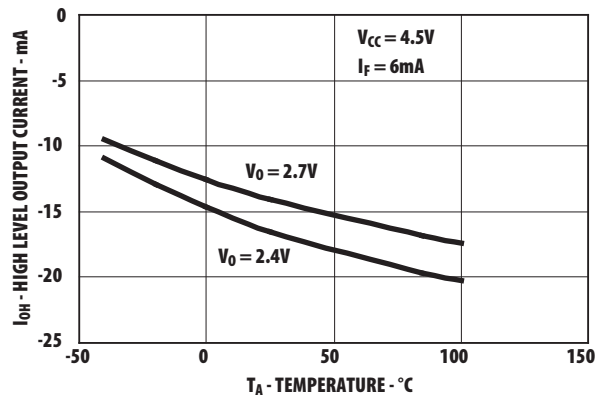

Figure 2. Typical Logic High Output Current vs. Temperature

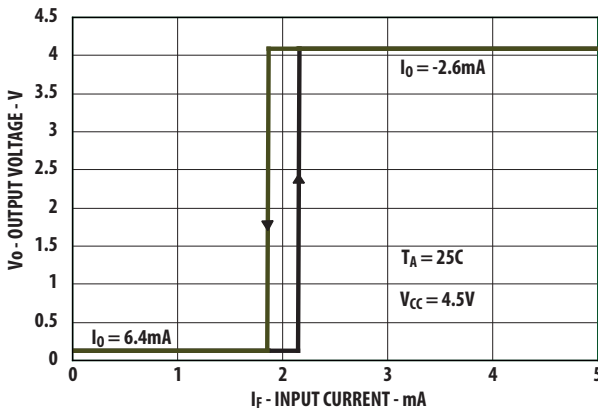

Figure 3. Typical Output Voltage vs. Forward Input Current

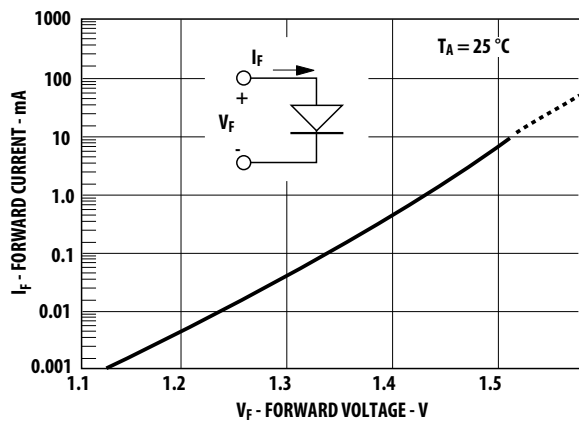

Figure 4. Typical Input Diode Forward Characteristic

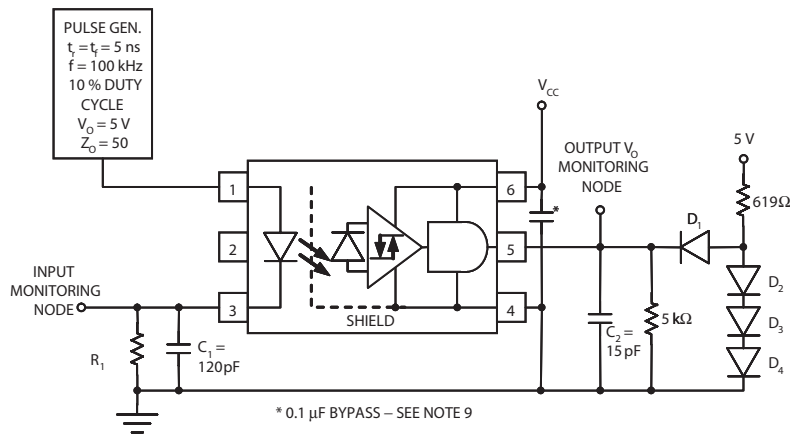
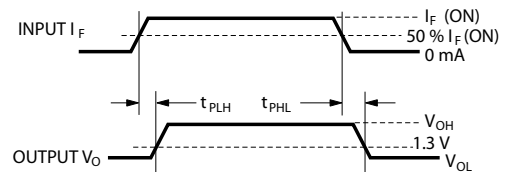

Figure 5. Circuit for t_{PLH} , t_{PHL} , t_r , t_f

THE PROBE AND JIG CAPACITANCES ARE INCLUDED IN C_1 AND C_2 .

R_1	580 Ω	330 Ω
$I_{F(ON)}$	6 mA	10 mA

ALL DIODES ARE 1N916 OR 1N3064.



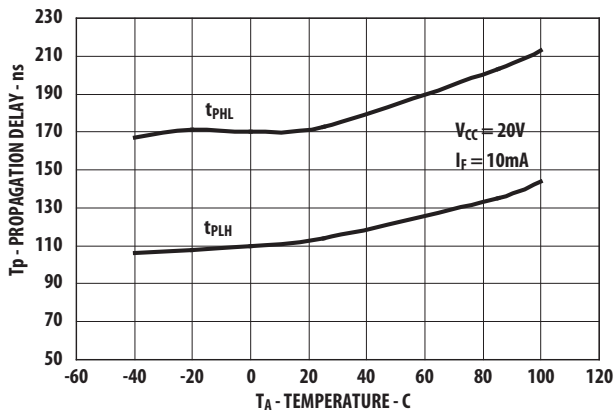

Figure 6. Typical Propagation Delays vs. Temperature.

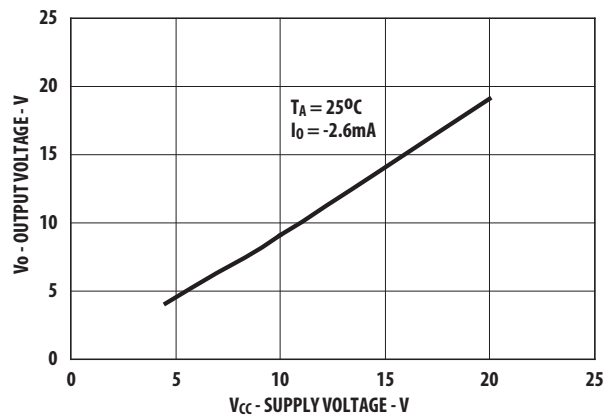

Figure 7. Typical Logic High Output Voltage vs. Supply Voltage

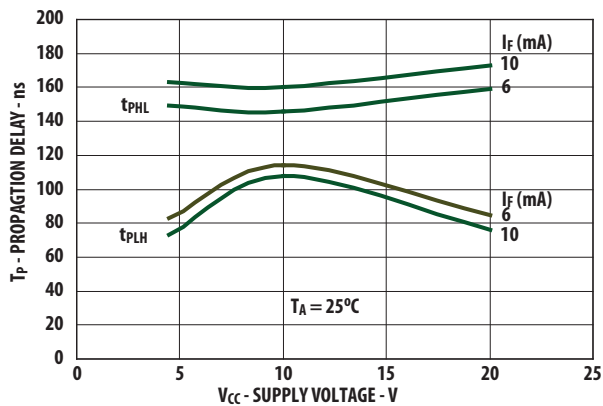

Figure 8. Typical Propagation Delay vs. Supply Voltage

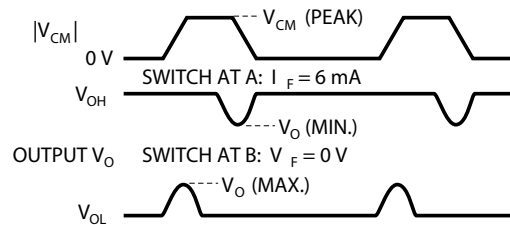
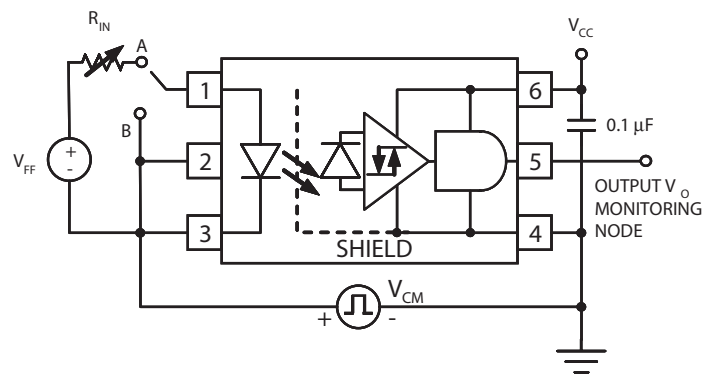

Figure 9. Test Circuit for Common Mode Transient Immunity and Typical Waveforms

For product information and a complete list of distributors, please go to our web site: www.avagotech.com

Avago, Avago Technologies, and the A logo are trademarks of Avago Technologies Limited in the United States and other countries. Data subject to change. Copyright © 2005-2008 Avago Technologies Limited. All rights reserved. Obsoletes AV01-0646EN AV02-1305EN - May 27, 2008

