

**CNY17-1 CNY17-3  
CNY17-2 CNY17-4**

**PACKAGE DIMENSIONS**

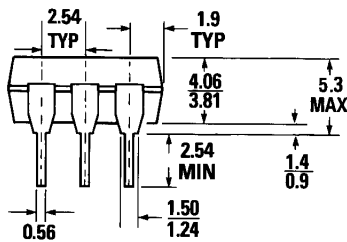
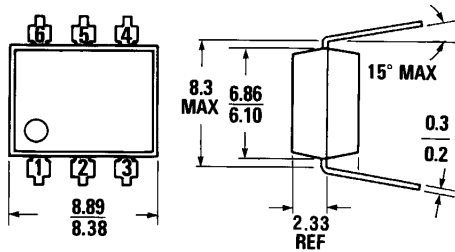

0.40 DIMENSIONS IN mm  
PACKAGE CODE K

ST1603A

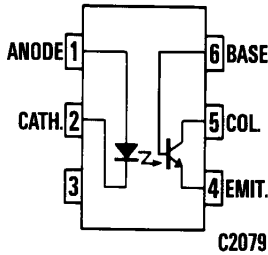

Equivalent Circuit

**DESCRIPTION**

The CNY17 series consists of a Gallium Arsenide IRED coupled with an NPN phototransistor.

**FEATURES**

- High isolation voltage  
5300 VAC RMS—1 minute  
7500 VAC PEAK—1 minute
- High  $BV_{CEO}$  minimum 70 volts
- Current transfer ratio in selected groups:  
CNY17-1: 40%- 80%  
CNY17-2: 63%-125%  
CNY17-3: 100%-200%  
CNY17-4: 160%-320%
- Maximum switching time in saturation specified
- Underwriters Laboratory (UL) recognized File #E90700

**APPLICATIONS**

- Power supply regulators
- Digital logic inputs
- Microprocessor inputs
- Appliance sensor systems
- Industrial controls

**ABSOLUTE MAXIMUM RATINGS**

**TOTAL PACKAGE**

Storage temperature .....	-55°C to 150°C
Operating temperature .....	-55°C to 100°C
Lead temperature (soldering, 10 sec) .....	260°C
Total package power dissipation @ 25°C (LED plus detector) .....	260 mW
Derate linearly from 25°C .....	3.5 mW/°C

**INPUT DIODE**

Forward DC current .....	90 mA
Reverse voltage .....	6 V
Peak forward current (1 $\mu$ s pulse, 300 pps) .....	3.0 A
Power dissipation 25°C ambient .....	135 mW
Derate linearly from 25°C .....	1.8 mW/°C

**OUTPUT TRANSISTOR**

Power dissipation @ 25°C .....	200 mW
Derate linearly from 25°C .....	2.67 mW/°C



## PHOTOTRANSISTOR OPTOCOUPERS

### ELECTRO-OPTICAL CHARACTERISTICS (25°C Temperature Unless Otherwise Specified)

INDIVIDUAL COMPONENT CHARACTERISTICS						
CHARACTERISTIC	SYMBOL	MIN.	TYP.	MAX.	UNITS	TEST CONDITIONS
<b>INPUT DIODE</b>						
Forward voltage	$V_f$		1.3	1.50	V	$I_f=60\text{ mA}$
Forward voltage temp. coefficient	$\frac{\Delta V_f}{\Delta T_A}$		-1.8		mV/°C	
Reverse voltage	$V_R$	6.0	15		V	$I_R=10\ \mu\text{A}$
Junction capacitance	$C_j$		50		pF	$V_f=0\text{ V}, f=1\text{ MHz}$
			65		pF	$V_f=1\text{ V}, f=1\text{ MHz}$
Reverse leakage current	$I_R$		.35	10	$\mu\text{A}$	$V_R=3.0\text{ V}$
<b>OUTPUT TRANSISTOR</b>						
DC forward current gain	$h_{FE}$	100	500			$V_{CE}=5\text{ V}, I_C=100\ \mu\text{A}$
Breakdown voltage						
Collector to emitter	$BV_{CEO}$	70			V	$I_C=1.0\text{ mA}, I_F=0$
Collector to base	$BV_{CBO}$	70			V	$I_C=10\ \mu\text{A}, I_F=0$
Emitter to collector	$BV_{ECO}$	7			V	$I_E=100\ \mu\text{A}, I_F=0$
Leakage current						
Collector to emitter	$I_{CEO}$		5	50	nA	$V_{CE}=10\text{ V}, I_F=0$
Collector to base	$I_{CBO}$			20	nA	$V_{CB}=10\text{ V}, I_F=0$
Capacitance						
Collector to emitter			8		pF	$V_{CE}=0, f=1\text{ MHz}$
Collector to base			20		pF	$V_{CB}=5, f=1\text{ MHz}$
Emitter to base			10		pF	$V_{EB}=0, f=1\text{ MHz}$

TRANSFER CHARACTERISTICS						
DC CHARACTERISTICS	SYMBOL	MIN.	TYP.	MAX.	UNITS	TEST CONDITIONS
Current Transfer Ratio, collector to emitter	CTR					$I_F=10\text{ mA}; V_{CE}=5\text{ V}$
		CNY17-1	40		80	
		CNY17-2	63		125	
		CNY17-3	100		200	
		CNY17-4	160		320	
Saturation voltage	$V_{CE(SAT)}$		0.27	.40	V	$I_F=10\text{ mA}; I_C=2.5\text{ mA}$

TRANSFER CHARACTERISTICS						
AC CHARACTERISTICS	SYMBOL	MIN.	TYP.	MAX.	UNITS	TEST CONDITIONS
<b>SWITCHING TIMES</b>						
Non-saturated						
Turn-on time	$t_{on}$		6.0	10	$\mu\text{s}$	$R_L=100\ \Omega; I_C=2\text{ mA}; V_{CC}=10\text{ V}$
Turn-off time	$t_{off}$		5.5	10	$\mu\text{s}$	See Fig. 10 and Fig. 11.

## ELECTRO-OPTICAL CHARACTERISTICS (25°C Temperature Unless Otherwise Specified) (Cont'd)

### TRANSFER CHARACTERISTICS (Cont'd)

AC CHARACTERISTICS	SYMBOL	MIN.	TYP.	MAX.	UNITS	TEST CONDITIONS
<b>SATURATED SWITCHING TIMES</b>						
Turn-on time	$t_{on}$					
CNY17-1			3.0	5.5	$\mu\text{s}$	$I_F = 20 \text{ mA}, V_{CE} = 0.4 \text{ V}$
CNY17-2, CNY17-3, CNY17-4			4.2	8.0	$\mu\text{s}$	$I_F = 10 \text{ mA}, V_{CE} = 0.4 \text{ V}$
Rise-time	$t_r$					
CNY17-1			2.0	4.0	$\mu\text{s}$	$I_F = 20 \text{ mA}, V_{CE} = 0.4 \text{ V}$
CNY17-2, CNY17-3, CNY17-4			3.0	6.0	$\mu\text{s}$	$I_F = 10 \text{ mA}, V_{CE} = 0.4 \text{ V}$
Turn-off time	$t_{off}$					
CNY17-1			18	34	$\mu\text{s}$	$I_F = 20 \text{ mA}, V_{CE} = 0.4 \text{ V}$
CNY17-2, CNY17-3, CNY17-4			23	39	$\mu\text{s}$	$I_F = 10 \text{ mA}, V_{CE} = 0.4 \text{ V}$
Fall-time	$t_f$					
CNY17-1			11	20	$\mu\text{s}$	$I_F = 20 \text{ mA}, V_{CE} = 0.4 \text{ V}$
CNY17-2, CNY17-3, CNY17-4			14	24	$\mu\text{s}$	$I_F = 10 \text{ mA}, V_{CE} = 0.4 \text{ V}$

### ISOLATION CHARACTERISTICS

CHARACTERISTICS	SYMBOL	MIN.	TYP.	MAX.	UNITS	TEST CONDITIONS
Isolation Voltage	$V_{iso}$	5300			$V_{AC} \text{ RMS}$	$I_{i,o} \leq 1 \mu\text{A}, 1 \text{ minute}$
	$V_{iso}$	7500			$V_{AC} \text{ PEAK}$	$I_{i,o} \leq 1 \mu\text{A}, 1 \text{ minute}$
Isolation resistance	$R_{iso}$	$10^{11}$			ohms	$V_{i,o} = 500 \text{ VDC}$
Isolation capacitance	$C_{iso}$		0.5		pF	$f = 1 \text{ MHz}$

### ELECTRICAL CHARACTERISTIC CURVES (25°C Free Air Temperature Unless Otherwise Specified)

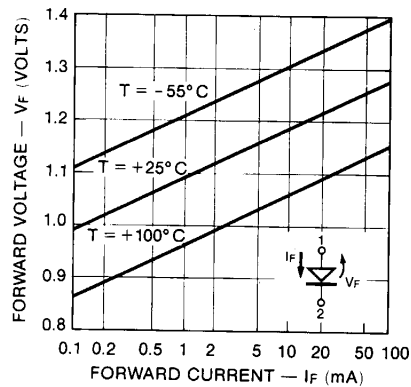

Fig. 1. Forward Voltage vs. Current

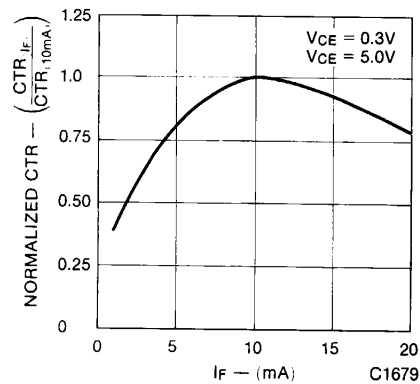

Fig. 2. Normalized CTR vs. Forward Current

**ELECTRICAL CHARACTERISTIC CURVES**  
(25°C Free Air Temperature Unless Otherwise Specified) (Cont'd)

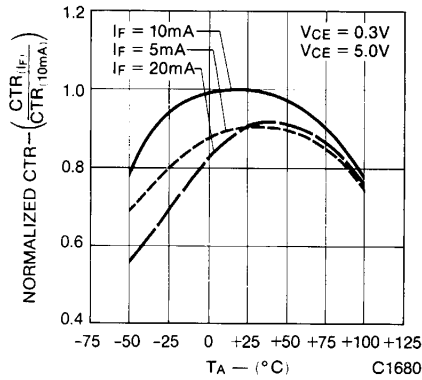

Fig. 3. Normalized CTR vs. Temperature

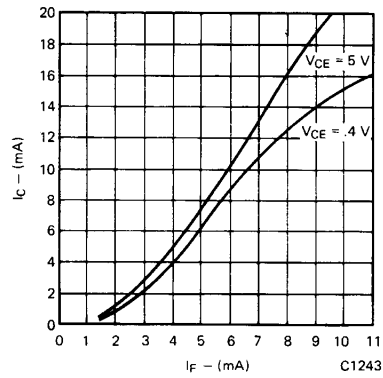

Fig. 4. Collector Current vs. Forward Current

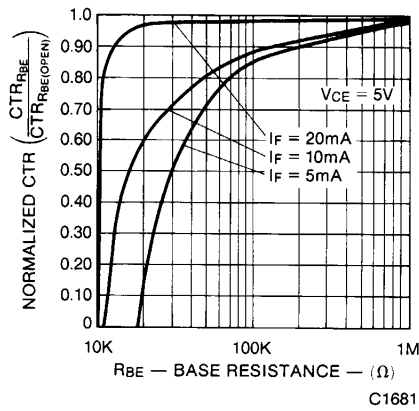

Fig. 5. CTR vs. R<sub>BE</sub> (Unsaturated)

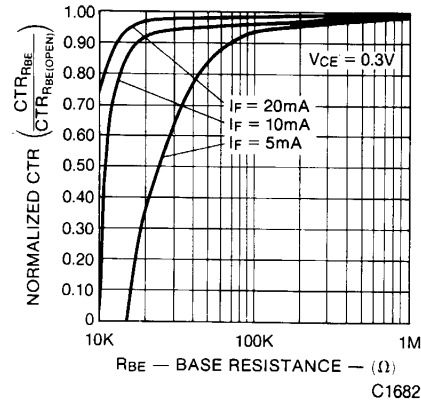

Fig. 6. CTR vs. R<sub>BE</sub> (Saturated)

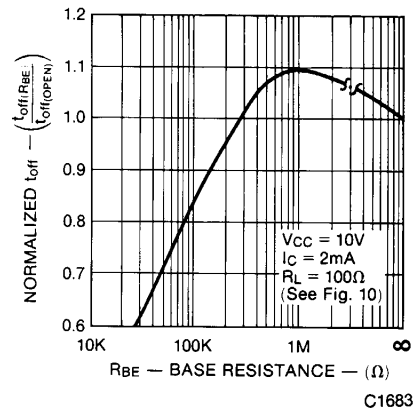

Fig. 7. Normalized T<sub>off</sub> vs. R<sub>BE</sub>

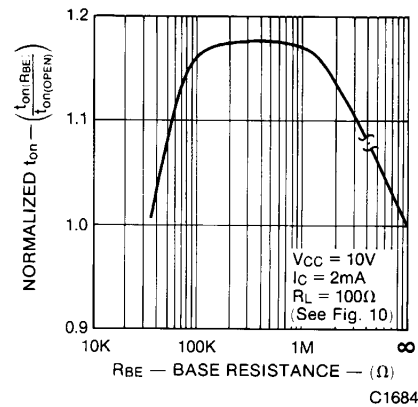

Fig. 8. Normalized T<sub>on</sub> vs. R<sub>BE</sub>

**ELECTRICAL CHARACTERISTIC CURVES**  
(25°C Free Air Temperature Unless Otherwise Specified) (Cont'd)

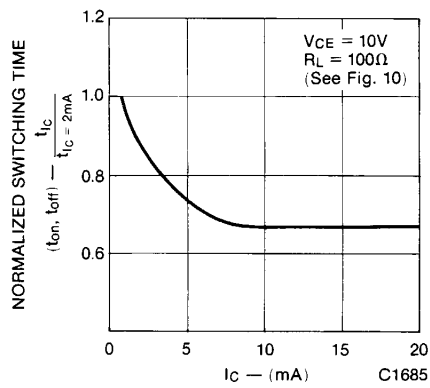

Fig. 9. Switching Time vs.  $I_C$

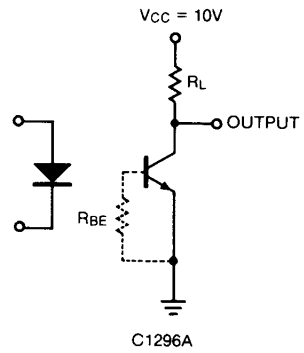

Fig. 10. Switching Time Test Circuit

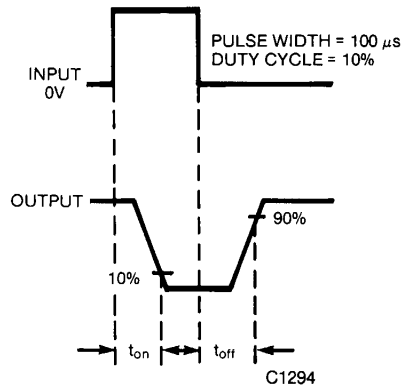

Fig. 11. Switching Time Waveforms