

FEATURES

- Temperature measurements require no external components
- Measures temperatures from -55°C to +125°C in 0.03125°C increments. Fahrenheit equivalent is -67°F to +257°F in 0.05625°F increments
- Temperature is read as a 13-bit value (two byte transfer)
- Converts temperature to digital word in 1 second (max)
- 256 bytes of E² memory on board for storing information such as frequency compensation coefficients
- Data is read from/written via a 2-wire serial interface (open drain I/O lines)
- Applications include temperature-compensated crystal oscillators for test equipment and radio systems
- 8-pin DIP or SOIC packages

PIN ASSIGNMENT

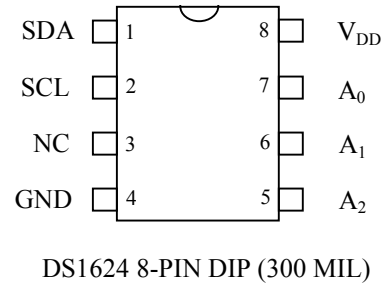
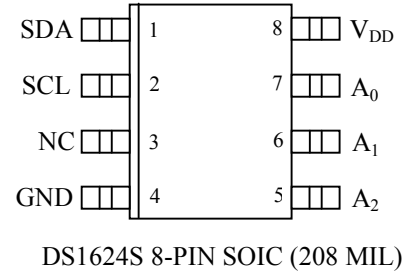

PIN DESCRIPTION

- SDA - 2-Wire Serial Data Input/Output
- SCL - 2-Wire Serial Clock
- GND - Ground
- A0 - Chip Address Input
- A1 - Chip Address Input
- A2 - Chip Address Input
- V_{DD} - Digital Power Supply (+3V - +5V)
- NC - No Connection

DESCRIPTION

The DS1624 consists of a digital thermometer and 256 bytes of E² memory. The thermometer provides 13-bit temperature readings which indicate the temperature of the device. The E² memory allows a user to store frequency compensation coefficients for digital correction of crystal frequency due to temperature. Any other type of information may also reside in this user space.

ORDERING INFORMATION

ORDERING INFORMATION	PACKAGE MARKING	DESCRIPTION
DS1624	DS1624	DS1624 in 300 mil 8-pin DIP
DS1624+	DS1624 (See Note)	DS1624 in Lead-Free 300 mil 8-pin DIP
DS1624S	DS1624S	DS1624 in 208 mil 8-pin SO
DS1624S+	DS1624S (See Note)	DS1624 in Lead-Free 208 mil 8-pin SO
DS1624S/T&R	DS1624S	DS1624 in 208 mil 8-pin SO, 2000 Piece Tape-and-Reel
DS1624S+T&R	DS1624S (See Note)	DS1624 in Lead-Free 208 mil 8-pin SO, 2000 Piece Tape-and-Reel

Note: A “+” symbol will also be marked on the package near the Pin 1 indicator.

DETAILED PIN DESCRIPTION Table 1

PIN	SYMBOL	DESCRIPTION
1	SDA	Data input/output pin for 2-wire serial communication port.
2	SCL	Clock input/output pin for 2-wire serial communication port.
3	NC	No connect. No Internal Connection.
4	GND	Ground pin.
5	A2	Address input pin.
6	A1	Address input pin.
7	A0	Address input pin.
8	V _{DD}	Supply Voltage 2.7V to 5.5V input power pin.

OVERVIEW

A block diagram of the DS1624 is shown in Figure 1. The DS1624 consists of two separate functional units: 1) a 256-byte nonvolatile E² memory, and 2) a direct-to-digital temperature sensor.

The nonvolatile memory is made up of 256 bytes of E² memory. This memory may be used to store any type of information the user wishes; for example, frequency compensation coefficients may be placed in this memory to allow for compensation of measured frequency depending upon the temperature at which the measurement is made. These memory locations are accessed through the 2-wire serial bus.

The direct to digital temperature sensor allows the DS1624 to measure the ambient temperature and report the temperature value in a 13-bit word, with 0.03125°C resolution. The temperature sensor and its related registers are accessed through the 2-wire serial interface.

DS1624 FUNCTIONAL BLOCK DIAGRAM Figure 1

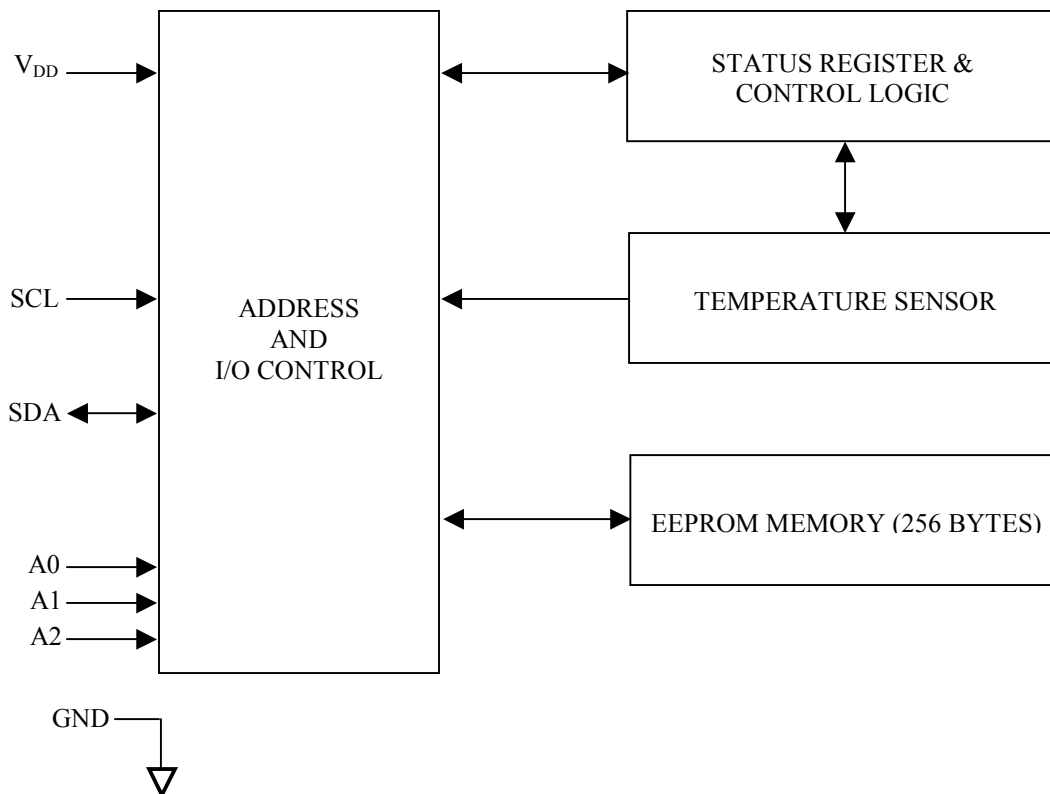

2-WIRE SERIAL DATA BUS

The DS1624 supports a bi-directional two-wire bus and data transmission protocol. A device that sends data onto the bus is defined as a transmitter, and a device receiving data as a receiver. The device that controls the message is called a “master”. The devices that are controlled by the master are “slaves”. The bus must be controlled by a master device which generates the serial clock (SCL), controls the bus access, and generates the START and STOP conditions. The DS1624 operates as a slave on the two-wire bus. Connections to the bus are made via the open-drain I/O lines SDA and SCL. The following bus protocol has been defined (See Figure 2):

- Data transfer may be initiated only when the bus is not busy.
- During data transfer, the data line must remain stable whenever the clock line is HIGH. Changes in the data line while the clock line is high will be interpreted as control signals.

Accordingly, the following bus conditions have been defined:

Bus not busy: Both data and clock lines remain HIGH.

Start data transfer: A change in the state of the data line, from HIGH to LOW, while the clock is HIGH, defines a START condition.

Stop data transfer: A change in the state of the data line, from LOW to HIGH, while the clock line is HIGH, defines the STOP condition.

Data valid: The state of the data line represents valid data when, after a START condition, the data line is stable for the duration of the HIGH period of the clock signal. The data on the line must be changed during the LOW period of the clock signal. There is one clock pulse per bit of data.

Each data transfer is initiated with a START condition and terminated with a STOP condition. The number of data bytes transferred between START and STOP conditions is not limited, and is determined by the master device. The information is transferred byte-wise and each receiver acknowledges with a ninth bit.

Within the bus specifications a regular mode (100 KHz clock rate) and a fast mode (400 KHz clock rate) are defined. The DS1624 works in both modes.

Acknowledge: Each receiving device, when addressed, is obliged to generate an acknowledge after the reception of each byte. The master device must generate an extra clock pulse which is associated with this acknowledge bit.

A device that acknowledges must pull down the SDA line during the acknowledge clock pulse in such a way that the SDA line is stable LOW during the HIGH period of the acknowledge related clock pulse. Of course, setup and hold times must be taken into account. A master must signal an end of data to the slave by not generating an acknowledge bit on the last byte that has been clocked out of the slave. In this case, the slave must leave the data line HIGH to enable the master to generate the STOP condition.

DATA TRANSFER ON 2-WIRE SERIAL BUS Figure 2

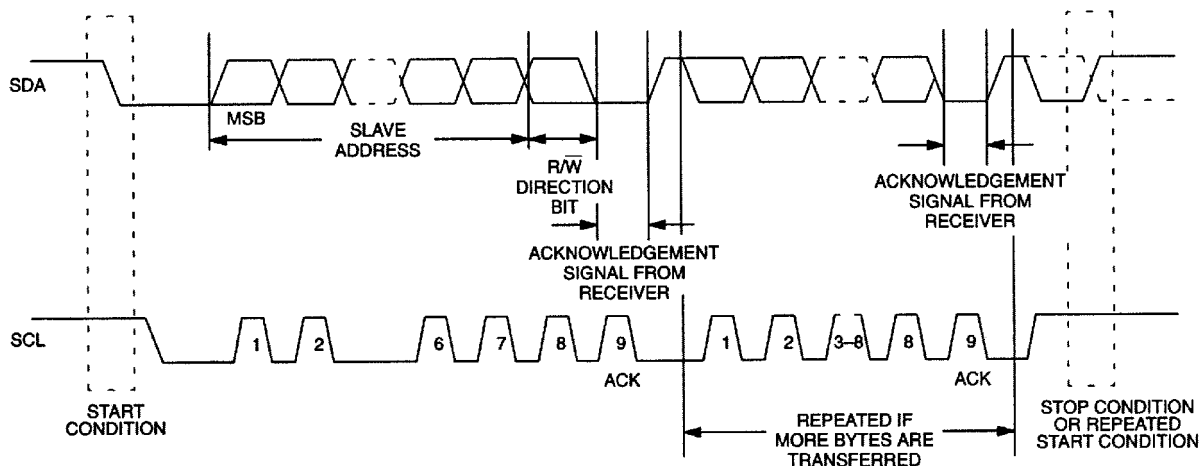

Figure 2 details how data transfer is accomplished on the two-wire bus. Depending upon the state of the R/W bit, two types of data transfer are possible:

1. **Data transfer from a master transmitter to a slave receiver.** The first byte transmitted by the master is the slave address. Next follows a number of data bytes. The slave returns an acknowledge bit after each received byte.
2. **Data transfer from a slave transmitter to a master receiver.** The first byte (the slave address) is transmitted by the master. The slave then returns an acknowledge bit. Next follows a number of data bytes transmitted by the slave to the master. The master returns an acknowledge bit after all received bytes other than the last byte. At the end of the last received byte, a 'not acknowledge' is returned.

The master device generates all of the serial clock pulses and the START and STOP conditions. A transfer is ended with a STOP condition or with a repeated START condition. Since a repeated START condition is also the beginning of the next serial transfer, the bus will not be released.

The DS1624 may operate in the following two modes:

1. **Slave receiver mode:** Serial data and clock are received through SDA and SCL. After each byte is received an acknowledge bit is transmitted. START and STOP conditions are recognized as the beginning and end of a serial transfer. Address recognition is performed by hardware after reception of the slave address and direction bit.
2. **Slave transmitter mode:** The first byte is received and handled as in the slave receiver mode. However, in this mode the direction bit will indicate that the transfer direction is reversed. Serial data is transmitted on SDA by the DS1624 while the serial clock is input on SCL. START and STOP conditions are recognized as the beginning and end of a serial transfer.

SLAVE ADDRESS

A control byte is the first byte received following the START condition from the master device. The control byte consists of a four bit control code; for the DS1624, this is set as 1001 binary for read and write operations. The next three bits of the control byte are the device select bits (A2, A1, A0). They are used by the master device to select which of eight devices are to be accessed. These bits are in effect the three least significant bits of the slave address. The last bit of the control byte (R/ \bar{W}) defines the operation to be performed. When set to a "1", a read operation is selected, when set to a "0", a write operation is selected. Following the START condition the DS1624 monitors the SDA bus checking the device type identifier being transmitted. Upon receiving the 1001 code and appropriate device select bits, the slave device outputs an acknowledge signal on the SDA line.

2-WIRE SERIAL COMMUNICATION WITH DS1624 Figure 3

Write to DS1624

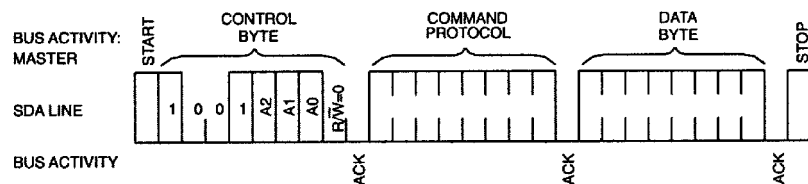

Read from DS1624

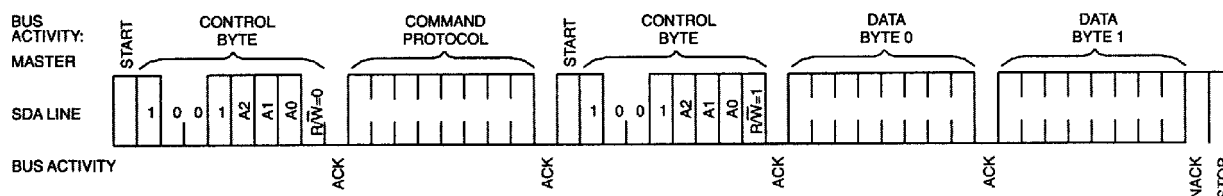

OPERATION-MEASURING TEMPERATURE

A block diagram of the DS1624 is shown in Figure 1. The DS1624 measures temperatures through the use of an on-board proprietary temperature measurement technique. A block diagram of the temperature measurement circuitry is shown in Figure 4.

The DS1624 measures temperature by counting the number of clock cycles that an oscillator with a low temperature coefficient goes through during a gate period determined by a high temperature coefficient oscillator. The counter is preset with a base count that corresponds to -55°C . If the counter reaches zero before the gate period is over the temperature register, which is also preset to the -55°C value, is incremented indicating that the temperature is higher than -55°C .

At the same time, the counter is preset with a value determined by the slope accumulator circuitry. This circuitry is needed to compensate for the parabolic behavior of the oscillators over temperature. The counter is then clocked again until it reaches zero. If the gate period is still not finished, then this process repeats.

The slope accumulator is used to compensate for the nonlinear behavior of the oscillators over temperature, yielding a high resolution temperature measurement. This is done by changing the number of counts necessary for the counter to go through for each incremental degree in temperature. To obtain the desired resolution, both the value of the counter and the number of counts per $^{\circ}\text{C}$ (the value of the slope accumulator) at a given temperature must be known.

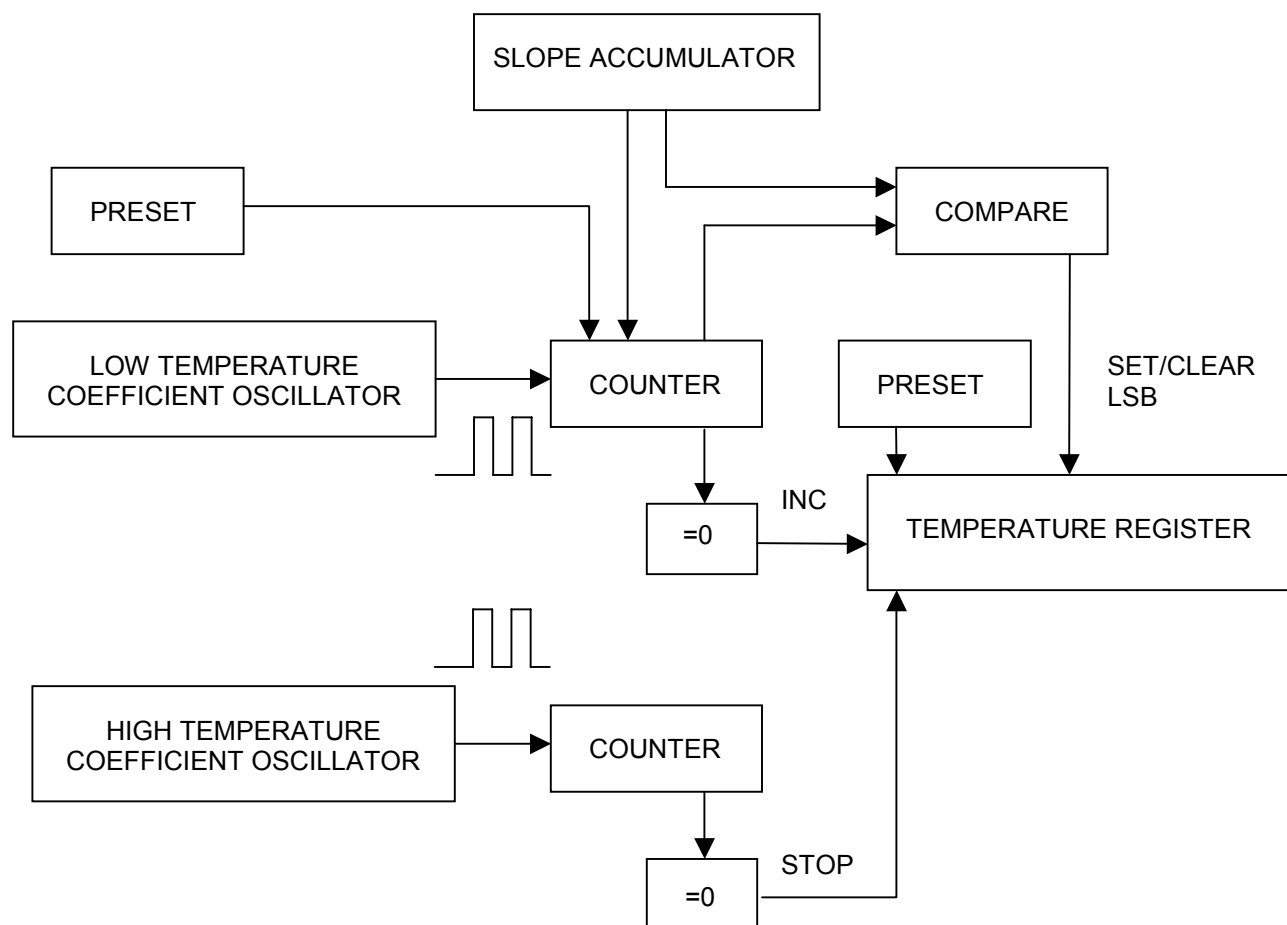
TEMPERATURE MEASURING CIRCUITRY Figure 4

Internally, this calculation is performed by the DS1624 to provide 0.03125°C resolution. The temperature reading is provided in a 13-bit, two's complement reading by issuing READ TEMPERATURE command. Table 2 describes the exact relationship of output data to measured temperature. The data is transmitted serially through the 2-wire serial interface, MSB first. The DS1624 can measure temperature over the range of -55°C to +125°C in 0.03125°C increments. For Fahrenheit usage a lookup table or conversion factor must be used.

TEMPERATURE/DATA RELATIONSHIPS Table 2

TEMP	DIGITAL OUTPUT (Binary)	DIGITAL OUTPUT (Hex)
+125°C	01111101 00000000	7D00h
+25.0625°C	00011001 00010000	1910h
+½°C	00000000 10000000	0080h
+0°C	00000000 00000000	0070h
-½°C	11111111 10000000	FF80h
-25.0625°C	11100110 11110000	E6F0h
-55°C	11001001 00000000	C900h

Since data is transmitted over the 2-wire bus MSB first, temperature data may be written to/read from the DS1624 as either a single byte (with temperature resolution of 1°C) or as two bytes, the second byte containing the value of the 5 least significant bits of the temperature reading as shown in Table 1. Note that the remaining three bits of this byte are set to all 0's.

Temperature is represented in the DS1624 in terms of a 0.03125°C LSB, yielding the following 13-bit format:

MSB							LSB								
0	0	0	1	1	0	0	1	0	0	0	1	0	0	0	0

= +25.0625°C

OPERATION AND CONTROL

A configuration/status register is used to determine the method of operation of the DS1624 will use in a particular application as well as indicating the status of the temperature conversion operation.

The configuration register is defined as follows:

CONFIGURATION/STATUS REGISTER

DONE	1	0	0	1	0	1	1SHOT
------	---	---	---	---	---	---	-------

where

DONE = Conversion Done bit. “1” = Conversion complete, “0” = conversion in progress.

1SHOT = One Shot Mode. If 1SHOT is “1”, the DS1624 will perform one temperature conversion upon receipt of the Start Convert T protocol. If 1SHOT is “0”, the DS1624 will continuously perform temperature conversions. This bit is nonvolatile and the DS1624 is shipped with 1SHOT = “0”.

Since the configuration register is implemented in E², writes to the register require 10 ms to complete. After issuing a command to write to the configuration register, no further accesses to the DS1624 should be made for at least 10 ms.

OPERATION – MEMORY

BYTE PROGRAM MODE

In this mode, the master sends addresses and one data byte to the DS1624.

Following a START condition, the device code (4-bit), the slave address (3 bit), and the R/ \overline{W} bit, which is logic LOW, are placed onto the bus by the master. The master then sends the Access Memory protocol. This indicates to the addressed DS1624 that a byte with a word address will follow after it has generated an acknowledge bit. Therefore, the next byte transmitted by the master is the word address and will be written into the address pointer of the DS1624. After receiving the acknowledge of the DS1624, the master device transmits the data word to be written into the addressed memory location. The DS1624 acknowledges again and the master generates a STOP condition. This initiates the internal programming cycle of the DS1624. A repeated START condition, instead of a STOP condition, will abort the programming operation.

During the programming cycle the DS1624 will not acknowledge any further accesses to the device until the programming cycle is complete (approximately 10 ms.)

PAGE PROGRAM MODE

To program the DS1624 the master sends addresses and data to the DS1624 which is the slave. This is done by supplying a START condition followed by the 4-bit device code, the 3-bit slave address, and the $\overline{R/\overline{W}}$ bit which is defined as a logic LOW for a write. The master then sends the Access Memory protocol. This indicates to the addressed slave that a word address will follow. The slave outputs the acknowledge pulse to the master during the ninth clock pulse. When the word address is received by the DS1624 it is placed in the address pointer defining which memory location is to be written. The DS1624 will generate an acknowledge after every 8-bits received and store them consecutively in an 8-byte RAM until a STOP condition is detected which initiates the internal programming cycle.

A repeated START condition, instead of a STOP condition, will abort the programming operation. During the programming cycle the DS1624 will not acknowledge any further accesses to the device until the programming cycle is complete (approximately 10 ms).

If more than 8 bytes are transmitted by the master the DS1624 will roll over and overwrite the data beginning with the first received byte. This does not affect erase/ write cycles of the EEPROM array and is accomplished as a result of only allowing the address register's bottom 3 bits to increment while the upper 5 bits remain unchanged. The DS1624 is capable of 50,000 writes (25,000 erase/write cycles) before EEPROM wear out may occur.

If the master generates a STOP condition after transmitting the first data word, byte programming mode is entered.

READ MODE

In this mode, the master is reading data from the DS1624 E² memory. The master first provides the slave address to the device with $\overline{R/\overline{W}}$ set to "0". The master then sends the Access Memory protocol and, after receiving an acknowledge, then provides the word address, which is the address of the memory location at which it wishes to begin reading. Note that while this is a read operation the address pointer must first be written. During this period the DS1624 generates acknowledge bits as defined in the appropriate section.

The master now generates another START condition and transmits the slave address. This time the $\overline{R/\overline{W}}$ bit is set to "1" to put the DS1624 in read mode. After the DS1624 generates the acknowledge bit it outputs the data from the addressed location on the SDA pin, increments the address pointer, and, if it receives an acknowledge from the master, transmits the next consecutive byte. This auto-increment sequence is only aborted when the master sends a STOP condition instead of an acknowledge. When the address pointer reaches the end of the 256-byte memory space (address FFh) it will increment from the end of the memory back to the first location of the memory (address 00h).

COMMAND SET

Data and control information is read from and written to the DS1624 in the format shown in Figure 3. To write to the DS1624, the master will issue the slave address of the DS1624 and the $\overline{R/\overline{W}}$ bit will be set to "0". After receiving an acknowledge the bus master provides a command protocol. After receiving this protocol the DS1624 will issue an acknowledge then the master may send data to the DS1624. If the DS1624 is to be read, the master must send the command protocol as before then issue a repeated START condition and the control byte again, this time with the $\overline{R/\overline{W}}$ bit set to "1" to allow reading of the data from the DS1624. The command set for the DS1624 as shown in Table 3 is as follows:

Access Memory [17h]

This command instructs the DS1624 to access its E² memory. After issuing this command, the next data byte is the value of the word address to be accessed. See OPERATION–MEMORY section for detailed explanations of the use of this protocol and data format following it.

Access Config [ACh]

If $\overline{R/\overline{W}}$ is “0”, this command writes to the configuration register. After issuing this command, the next data byte is the value to be written into the configuration register. If $\overline{R/\overline{W}}$ is “1”, the next data byte read is the value stored in the configuration register.

Read Temperature [AAh]

This command reads the last temperature conversion result. The DS1624 will send two bytes in the format described earlier, which are the contents of this register.

Start Convert T [EEh]

This command begins a temperature conversion. No further data is required. In one–shot mode the temperature conversion will be performed and then the DS1624 will remain idle. In continuous mode this command will initiate continuous conversions.

Stop Convert T [22h]

This command stops temperature conversion. No further data is required. This command may be used to halt a DS1624 in continuous conversion mode. After issuing this command, the current temperature measurement will be completed then the DS1624 will remain idle until a Start Convert T is issued to resume continuous operation.

DS1624 COMMAND SET Table 3

INSTRUCTION	DESCRIPTION	PROTOCOL	2-WIRE BUS DATA AFTER ISSUING PROTOCOL	NOTES
TEMPERATURE CONVERSION COMMANDS				
Read Temperature	Reads last converted temperature value from temperature register.	AAh	<read 2 bytes data>	
Start Convert T	Initiates temperature conversion.	EEh	idle	1
Stop Convert T	Halts temperature conversion.	22h	idle	1
THERMOSTAT COMMANDS				
Access Memory	Reads or writes to 256-byte EEPROM memory.	17h	<write data>	2
Access Config	Reads or writes configuration data to configuration register.	ACh	<write data>	2

NOTES:

- In continuous conversion mode a Stop Convert T command will halt continuous conversion. To restart, the Start Convert T command must be issued. In one–shot mode a Start Convert T command must be issued for every temperature reading desired.
- Writing to the E² typically requires 10 ms at room temperature. After issuing a write command, no further reads or writes should be requested for at least 10 ms.

During the programming cycle the DS1624 will not acknowledge any further accesses to the device until the programming cycle is complete (approximately 10 ms).

MEMORY FUNCTION EXAMPLE

BUS MASTER MODE	DS1624 MODE	DATA (MSB FIRST)	COMMENTS	NOTES
{Command protocol for configuration register} {Start here}				
TX	RX	START	Bus Master Initiates a Start condition.	
TX	RX	<addr,0>	Bus Master sends DS1624 address; $R/\bar{w} = "0"$;	
RX	TX	ACK	DS1624 generates acknowledge bit.	
TX	RX	ACh	Bus Master sends Access Config command protocol.	
RX	TX	ACK	DS1624 generates acknowledge bit.	1
TX	RX	00h	Bus Master sets up DS1624 for continuous conversion.	
RX	TX	ACK	DS1624 generates acknowledge bit.	2, 4
TX	RX	STOP	Bus Master initiates the STOP condition.	
{Command protocol for Start Convert T} {Start here}				
TX	RX	START	Bus Master initiates a Start condition.	
TX	RX	<addr,0>	Bus Master sends DS1624 address; $R/\bar{w} = 0$;	
RX	TX	ACK	DS1624 generates acknowledge bit.	
TX	RX	EEh	Bus Master sends Start Convert T command protocol.	
RX	TX	ACK	DS1624 generates acknowledge bit.	1
TX	RX	STOP	Bus Master initiates the STOP condition.	
{Command protocol for reading the Temperature} {Start here}				
TX	RX	START	Bus Master initiates a Start condition.	
TX	RX	<addr,0>	Bus Master sends DS1624 address; $R/\bar{w} = 0$;	
RX	TX	ACK	DS1624 generates acknowledge bit.	
TX	RX	AAh	Bus Master sends Read Temp command protocol.	
RX	TX	ACK	DS1624 generates acknowledge bit.	1
TX	RX	START	Bus Master initiates a Repeated Start condition.	
TX	RX	<addr,1>	Bus Master sends DS1624 address; $R/\bar{w} = 1$;	
RX	TX	ACK	DS1624 generates acknowledge bit.	
RX	TX	<data>	DS1624 sends the MSB byte of Temperature.	
TX	RX	ACK	Bus Master generates acknowledge bit.	
RX	TX	<data>	DS1624 sends the LSB byte of Temperature.	

BUS MASTER MODE	DS1624 MODE	DATA (MSB FIRST)	COMMENTS	NOTES
TX	RX	NACK	Bus Master sends "NO ACKNOWLEDGE" bit.	
TX	RX	STOP	Bus Master initiates the STOP condition.	
{Command protocol for writing to EEPROM} {Start here}				
TX	RX	START	Bus Master initiates a Start condition.	
TX	RX	<addr,0>	Bus Master sends DS1624 address; R/ \bar{w} =0;	
RX	TX	ACK	DS1624 generates acknowledge bit.	
TX	RX	17h	Bus Master sends Access Memory command protocol.	
RX	TX	ACK	DS1624 generates acknowledge bit.	1
TX	RX	<addr>	Bus Master sets the starting memory address.	
RX	TX	ACK	DS1624 generates acknowledge bit.	
TX	RX	<data>	Bus Master sends the first byte of data.	
RX	TX	ACK	DS1624 generates acknowledge bit.	
TX	RX	<data>	Bus Master sends the second byte of data.	
RX	TX	ACK	DS1624 generates acknowledge bit.	
.	.	.	.	
.	.	.	.	
.	.	.	.	
.	.	.	.	
TX	RX	<data>	Bus Master sends the n-th byte of data.	3
RX	TX	ACK	DS1624 generates acknowledge bit.	
TX	RX	STOP	Bus Master initiates the STOP condition.	2, 4
{Command protocol for reading from EEPROM} {Start here}				
TX	RX	START	Bus Master initiates a Start condition.	
TX	RX	<addr,0>	Bus Master sends DS1624 address; R/ \bar{w} =0;	
RX	TX	ACK	DS1624 generates acknowledge bit.	
TX	RX	17h	Bus Master sends Access Memory command protocol.	
RX	TX	ACK	DS1624 generates acknowledge bit.	1
TX	RX	<addr>	Bus Master sends the starting memory address.	
RX	TX	ACK	DS1624 generates acknowledge bit.	
TX	RX	START	Bus Master initiates a Repeated Start condition.	
TX	RX	<addr,1>	Bus Master sends DS1624 address; R/ \bar{w} =1;	
RX	TX	ACK	DS1624 generates acknowledge bit.	
RX	TX	<data>	DS1624 sends the first byte of data.	
TX	RX	ACK	Bus Master generates acknowledge bit.	

BUS MASTER	DS1624	DATA (MSB)	COMMENTS	NOTES
RX	TX	<data>	DS1624 sends the second byte of data.	
TX	RX	ACK	Bus Master generates acknowledge bit.	
.	.	.	.	
.	.	.	.	
.	.	.	.	
.	.	.	.	
RX	TX	<data>	DS1624 sends the n-th byte of data.	5
TX	RX	NACK	Bus Master send "NO KNOWLEDGE" bit.	
TX	RX	STOP	Bus Master initiates the STOP condition.	

NOTES:

1. If this protocol follows a write and the DS1624 does not acknowledge here, restart the protocol at the Start here. If it does acknowledge, continue on.
2. Wait for write to complete (10 ms typ. 50 ms max). If DS1624 does not acknowledge the command protocol immediately following a configure register or write mem protocol, the DS1624 has not finished writing. Restart the new command protocol until the DS1624 acknowledges.
3. If n is greater than eight, the last eight bytes are the only bytes saved in memory. If the starting address is 00 and the incoming data is 00 11 22 33 44 55 66 77 88 99, the result will be mem0=88 mem1=99 mem2=22 mem3=33 mem4=44 mem5=55 mem6=66 mem7=77. The data wraps around and overwrites itself.
4. The STOP condition causes the DS1624 to initiate the write to EEPROM sequence. If a START condition comes instead of the STOP condition, the write is aborted. The data is not saved.
5. For reading, the address is incremented. If the starting address is 04h and 30 bytes of data are read out, 21h is the final address read.

ABSOLUTE MAXIMUM RATINGS*

Voltage on Any Pin Relative to Ground	-0.5V to +7.0V
Operating Temperature	-55°C to +125°C
Storage Temperature	-55°C to +125°C
Soldering Temperature	260°C for 10 seconds

* This is a stress rating only and functional operation of the device at these or any other conditions above those indicated in the operation sections of this specification is not implied. Exposure to absolute maximum rating conditions for extended periods of time may affect reliability.

RECOMMENDED DC OPERATING CONDITIONS

PARAMETER	SYMBOL	MIN	TYP	MAX	UNITS	NOTES
Supply Voltage	V _{DD}	2.7	5.0	5.5	V	1

DC ELECTRICAL CHARACTERISTICS (-55°C to +125°C; V_{DD}=2.7V to 5.5V)

PARAMETER	SYMBOL	CONDITION	MIN	TYP	MAX	UNITS	NOTES
Thermometer Error	T _{ERR}	0°C to 70°C -55°C to +0°C and +70°C to +125°C			±½	°C	10
			See Typical Curve				
Low Level Input Voltage	V _{IL}		-0.5		0.3V _{DD}	V	
High Level Input Voltage	V _{IH}		0.7V _{DD}		V _{DD} + 0.5	V	
Pulse width of spikes which must be suppressed by the input filter	t _{SP}	Fast Mode	0		50	ns	
Low Level Output Voltage	V _{OL1}	3 mA sink current	0		0.4	V	
	V _{OL2}	6 mA sink current	0		0.6	V	
Input Current each I/O pin		0.4 < V _{I/O} < 0.9V _{DD}	-10		+10	µA	2
I/O Capacitance	C _{I/O}				10	pF	
Active Supply Current	I _{CC}	Temperature Conversion			1000		
		E ² Write			400	µA	3, 4
		Communica- tion Only			100		
Standby Supply Current	I _{STBY}			1	3	µA	3, 4

AC ELECTRICAL CHARACTERISTICS (-55°C to +125°C; $V_{DD}=2.7V$ to 5.5V)

PARAMETERS	SYMBOL	CONDITION	MIN	TYP	MAX	UNITS	NOTES
Temperature Conversion Time	T_{TC}			400	1000	ms	
NV Write Cycle Time	t_{WR}	0°C to 70°C		10	50	ms	9
SLK Clock Frequency	f_{SCL}	Fast Mode Standard Mode	0 0		400 100	KHz	
Bus Free Time Between a STOP and START Condition	t_{BUF}	Fast Mode Standard Mode	1.3 4.7			μs	
Hold Time (Repeated) START Condition	$t_{HD:STA}$	Fast Mode Standard Mode	0.6 4.0			μs	5
Low Period of SCL Clock	t_{LOW}	Fast Mode Standard Mode	1.3 4.7			μs	
High Period of SCL Clock	t_{HIGH}	Fast Mode Standard Mode	0.6 4.0			μs	
Setup Time for a Repeated START Condition	$t_{SU:STA}$	Fast Mode Standard Mode	0.6 4.7			μs	
Data Hold Time	$t_{HD:DAT}$	Fast Mode Standard Mode	0 0		0.9	μs	6
Data Setup Time	$t_{SU:DAT}$	Fast Mode Standard Mode	100 250			ns	7
Rise Time of both SDA and SCL Signals	t_R	Fast Mode Standard Mode	$20+0.1C_B$		300 1000	ns	8
Fall Time of both SDA and SCL Signals	t_F	Fast Mode Standard Mode	$20+0.1C_B$		300 300	ns	8
Setup Time for STOP Condition	$t_{SU:STO}$	Fast Mode Standard Mode	0.6 4.0			μs	
Capacitive Load for each Bus Line	C_b				400	pF	

All values referred to $V_{IH}=0.9 V_{DD}$ and $V_{IL}=0.1 V_{DD}$.

AC ELECTRICAL CHARACTERISTICS (-55°C to +125°C; $V_{DD}=2.7V$ to 5.5V)

PARAMETER	SYMBOL	MIN	TYP	MAX	UNITS	NOTES
Input Capacitance	C_I		5		pF	

NOTES:

1. All voltages are referenced to ground.
2. I/O pins of fast mode devices must not obstruct the SDA and SCL lines if V_{DD} is switched off.
3. I_{CC} specified with SDA pin open.
4. I_{CC} specified with V_{CC} at 5.0V and SDA, SCL = 5.0V, 0°C to 70°C.
5. After this period, the first clock pulse is generated.
6. The maximum $t_{HD:DAT}$ has only to be met if the device does not stretch the LOW period (t_{LOW}) of the SCL signal.
7. A fast mode device can be used in a standard mode system, but the requirement $t_{SU:DAT} \geq 250$ ns must then be met. This will automatically be the case if the device does not stretch the LOW period of the SCL signal. If such a device does stretch the LOW period of the SCL signal, it must output the next data bit to the SDA line $t_{RMAX} + t_{SU:DAT} = 1000 + 250 = 1250$ ns before the SCL line is released.
8. C_b – total capacitance of one bus line in pF.
9. Writing to the nonvolatile memory should only take place in the 0°C to 70°C temperature range.
10. See Typical Curve for specification limits outside the 0°C to 70°C temperature range. Thermometer error reflects sensor accuracy as tested during calibration.

TIMING DIAGRAM

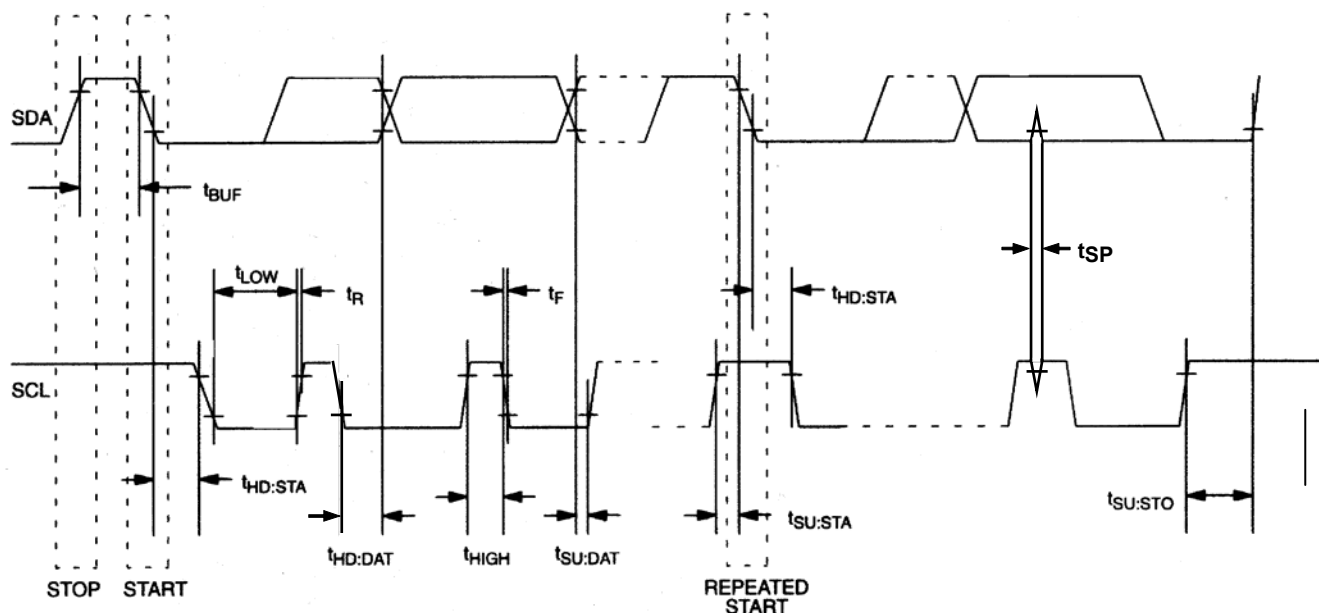

Note: The DS1624 does not delay the SDA line internally with respect to SCL for any length of time

TYPICAL PERFORMANCE CURVE

DS1624 DIGITAL THERMOMETER AND THERMOSTAT TEMPERATURE READING ERROR

