

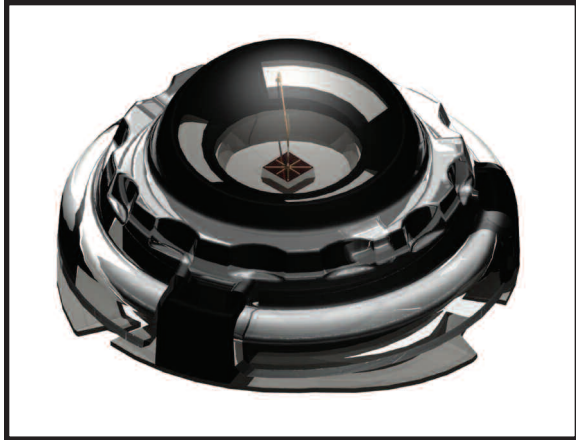

...the power is in the package



## 9900-1201-22

**Amber Power LED**

**Screw thread design**

**Lambertian radiation pattern**



### Typical Device Characteristics @ 350mA

<b>Luminous Flux</b>	<b>40 lumens</b>
<b>Dominant Wavelength</b>	<b>590 nm</b>
<b>Forward Voltage</b>	<b>2.30 V</b>
<b>Viewing Angle</b>	<b>130°</b>

### Product Features

- Solder-Free mechanical attachment for easy installation and replacement
- Annular contact arrangement eliminates need for radial alignment
- Excellent thermal coupling to lighting system
- Large LED chip allows high drive current
- Outstanding light output
- Wide viewing angle
- UV resistant cover lens
- RoHS Compliant

## Device Characteristics

Forward Current = 350mA, Junction Temperature,  $T_j = 25^\circ\text{C}$

	Minimum	Typical	Maximum
Luminous Flux ( $\phi_v$ )	28 lm	40 lm	
Dominant Wavelength ( $\lambda_D$ )	583 nm	590 nm	597 nm
Peak Wavelength ( $\lambda_p$ )		593 nm	
Spectral Half-Width ( $\Delta\lambda^{1/2}$ )		17 nm	
Viewing Angle ( $2\theta^{1/2}$ )		130°	
Forward Voltage ( $V_f$ )	2.00 V	2.30 V	3.00 V
Dynamic Resistance ( $R_D$ )		1.0 $\Omega$	
Thermal Resistance ( $R\theta_{j-c}$ )		12°C/W	

## Absolute Maximum Ratings

DC Forward Current	500 mA
Peak Pulsed Forward Current	750 mA
Maximum Pulse Duty Cycle	50%
Maximum Pulse Duration	10 ms
Reverse Voltage	> 5 V
LED Junction Temperature	125°C
Operating Temperature Range	-40°C to +85°C
Storage Temperature Range	-40°C to +100°C

# Mechanical Dimensions

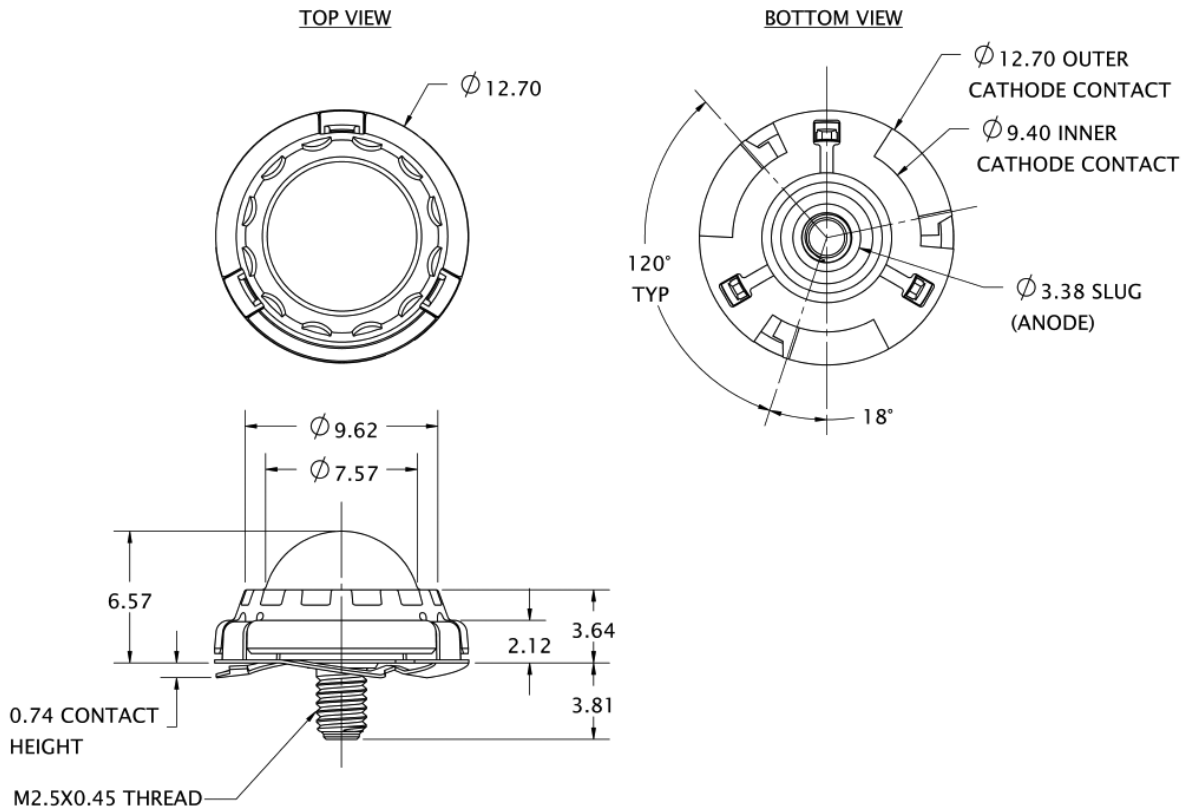

# Spatial Distribution Pattern

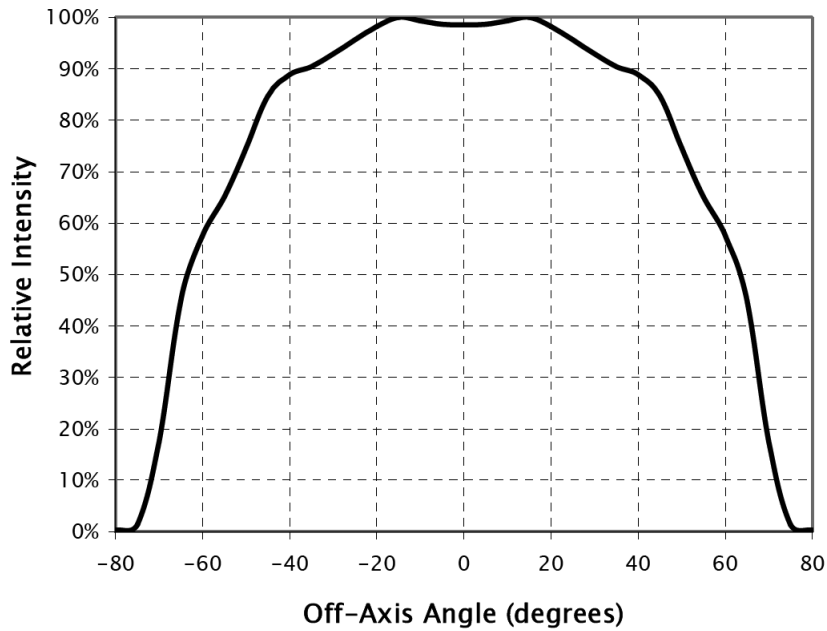

## Spectral Power Distribution

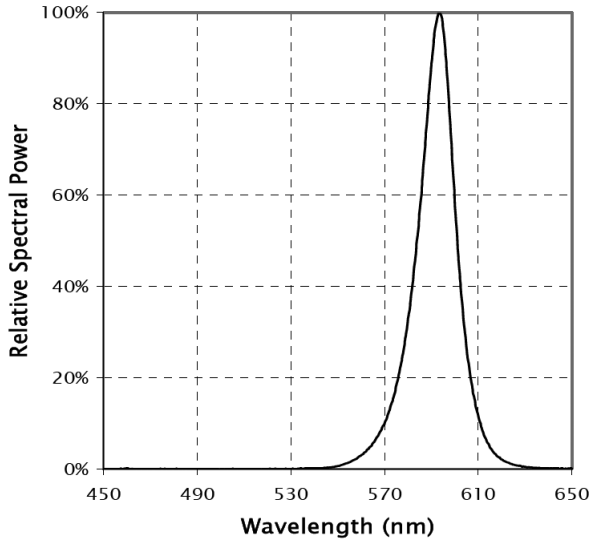

## Wavelength vs. Forward Current

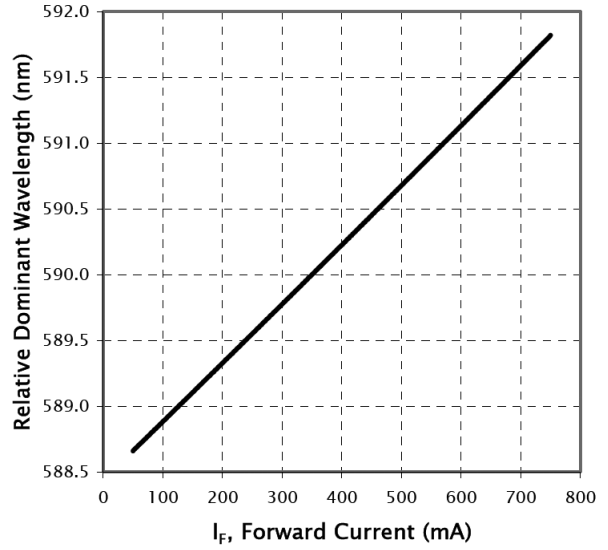

## Forward Voltage vs. Forward Current

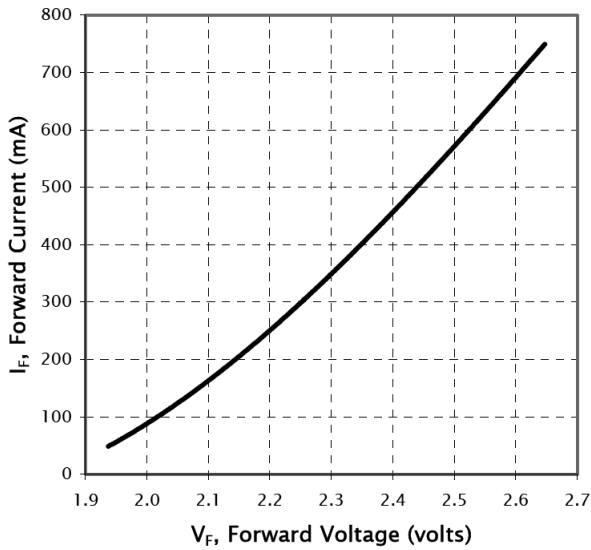

## Luminous Flux vs. Forward Current

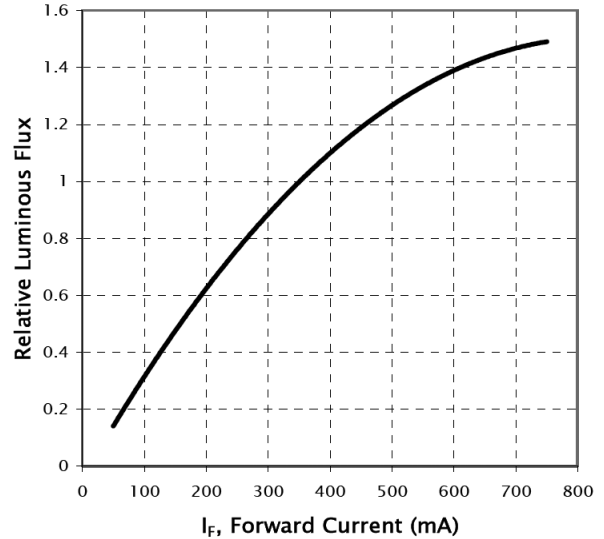

A product of Weldon | 3656 Paragon Drive | Columbus, Ohio 43228 USA  
800.989.2718 | 614.529.7230 | FAX 614.527.3547 | <http://www.v-led.com>

Weldon Technologies reserves the right to make changes at any time to product specifications without notice.