

# Solid-State Relays

## Features

- Rugged, epoxy encapsulation construction
- 4,000 volts of optical isolation
- Subjected to full load test and six times the rated current surge before and after encapsulation
- Unique heat-spreader technology
- UL and CSA recognized\*

## Overview

In 1974, Opto 22 introduced the first liquid epoxy-filled line of power solid-state relays (SSR). This innovation in SSR design greatly improved the reliability and reduced the cost of manufacturing. At that time, we also incorporated into our manufacturing process 100% testing under full load conditions of every relay we produced.

By 1978, Opto 22 had gained such a reputation for reliability that we were recognized as the world's leading manufacturer of solid-state relays. Through continuous manufacturing improvements and the same 100% testing policy established over 30 years ago, Opto 22 is still recognized today for the very high quality and reliability of all our solid-state relays.

## Part Numbers

Part	Description	Part	Description
120A10	120 VAC, 10 Amp, AC Control	480D10-12	480 VAC, 10 Amp, DC Control, Transient Proof
120A25	120 VAC, 25 Amp, AC Control	480D15-12	480 VAC, 15 Amp, DC Control, Transient Proof
240A10	240 VAC, 10 Amp, AC Control	480D25-12	480 VAC, 25 Amp, DC Control, Transient Proof
240A25	240 VAC, 25 Amp, AC Control	480D45-12	480 VAC, 45 Amp, DC Control, Transient Proof
240A45	240 VAC, 45 Amp, AC Control	575D15-12	575 VAC, 15 Amp, DC Control, Transient Proof
120D3	120 VAC, 3 Amp, DC Control	575D45-12	575 VAC, 45 Amp, DC Control, Transient Proof
120D10	120 VAC, 10 Amp, DC Control	575Di45-12	575 VAC, 45 Amp, DC Control, Transient Proof, with LED Indicators
120D25	120 VAC, 25 Amp, DC Control	Z120D10	Z Model, 120 VAC, 10 Amp, DC Control
120D45	120 VAC, 45 Amp, DC Control	Z240D10	Z Model, 240 VAC, 10 Amp, DC Control
240D3	240 VAC, 3 Amp, DC Control	MP120D2 or P120D2	120 VAC, 2 Amp, DC Control. P model is low profile.
240D10	240 VAC, 10 Amp, DC Control	MP120D4 or P120D4	120 VAC, 4 Amp, DC Control. P model is low profile.
240Di10	240 VAC, 10 Amp, DC Control, with LED Indicators	MP240D2 or P240D2	240 VAC, 2 Amp, DC. P model is low profile.
240D25	240 VAC, 25 Amp, DC Control	MP240D4 or P240D4	240 VAC, 4 Amp, DC. P model is low profile.
240Di25	240 VAC, 25 Amp, DC Control, with LED Indicators	MP380D4	380 VAC, 4 Amp, DC
240D45	240 VAC, 45 Amp, DC Control		
240Di45	240 VAC, 45 Amp, DC Control, with LED Indicators		
380D25	380 VAC, 25 Amp, DC Control		
380D45	380 VAC, 45 Amp, DC Control		

\*UL recognition is pending for Power Series SSRs with LED indicators. Contact Opto 22 Product Support for current UL information.



Opto 22 Power Series SSR

## Description

Opto 22 offers a complete line of SSRs, from the rugged 120/240/380-volt AC Series to the small footprint MP Series, designed for mounting on printed circuit boards. All Opto 22 SSRs feature 4,000 volts of optical isolation and are UL and CSA recognized.\* The innovative use of room-temperature liquid epoxy encapsulation, coupled with Opto 22's unique heat-spreader technology, are key to mass producing the world's most reliable solid state relays.

Every Opto 22 solid state relay is subjected to full load test and six times the rated current surge both before and after encapsulation. This double testing of every part before it leaves the factory means you can rely on Opto 22 solid state relays. All Opto 22 SSRs are guaranteed for life.

### Power Series SSRs



Opto 22 provides a full range of Power Series relays with a wide variety of voltage (120–575 volts) and current options (3–45 amps). All Power Series relays feature 4,000 volts of optical isolation and have a high PRV rating. Some Power Series relays include built-in LEDs to indicate operation.

### DC Series

The DC Series delivers isolated DC control to large OEM customers worldwide.

### AC Series

The AC Series offers the ultimate in solid state reliability. All AC Power Series relays feature a built-in snubber and zero voltage turn on. Transient-proof models offer self protection for noisy electrical environments.

### Z Series SSRs



The Z Series employs a unique heat transfer system that makes it possible for Opto 22 to deliver a low-cost, 10-amp, solid state relay in an all-plastic case. The push-on, tool-free quick-connect terminals make the Z Series ideal for high-volume OEM applications.

### Printed Circuit Series SSRs



Opto 22's Printed Circuit Series allows OEMs to easily deploy solid state relays on printed circuit boards. Two unique packages are available, both of which will switch loads up to four amps.

### MP Series

The MP Series packaging is designed with a minimum footprint to allow maximum relay density on the printed circuit board.

### P Series

The P Series power relays provide low-profile [0.5 in. (12.7 mm)] center mounting on printed circuit boards.

## Solid-State Relays

### Specifications (all Power Series models)

- 4,000 V optical isolation, input to output
- Zero voltage turn-on
- Turn-on time: 0.5 cycle maximum
- Turn-off time: 0.5 cycle maximum
- Operating frequency: 25 to 65 Hz (operates at 400 Hz with six times off-state leakage)
- Coupling capacitance, input to output: 8 pF maximum
- Hermetically sealed
- DV/DT Off-state: 200 volts per microsecond
- DV/DT commutating: snubbed for rated current at 0.5 power factor
- UL recognized\*
- CSA certified
- CE component

See Opto 22 form #986 for torque specifications.

### Safety Cover for Power Series SSRs

A plastic safety cover (Opto 22 part number SAFETY COVER) is optionally available for Opto 22 Power Series SSRs. The safety cover reduces the chance of accidental contact with relay terminals, while providing access holes for test instrumentation.

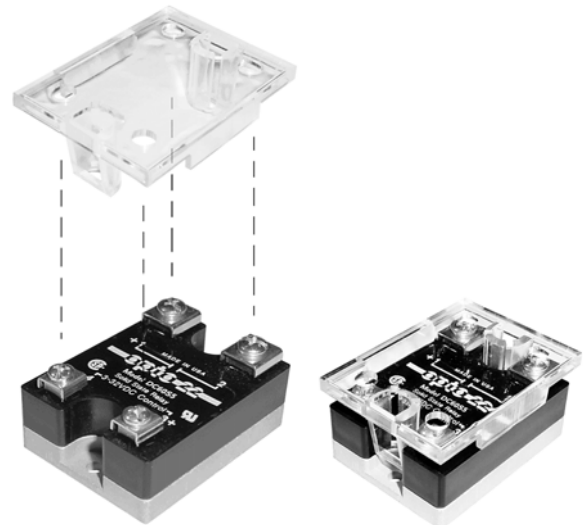

An optional plastic safety cover can be installed on a Power Series SSR.

\*UL recognition is pending for Power Series SSRs with LED indicators. Contact Opto 22 Product Support for current UL information.

# Solid-State Relays

## AC Power Series Specifications

Opto 22 provides a full range of Power Series relays with a wide variety of voltage (120–575) and current options (3–45 amps). All Power Series relays feature 4,000 volts of optical isolation and have a high PRV rating.

### 120/240/380 Volt

Model Number	Nominal AC Line Voltage	Nominal Current Rating (Amps)	1 cycle Surge (Amps) Peak	Nominal Signal Input Resistance (Ohms)	Signal Pick-up Voltage	Signal Drop-out Voltage	Peak Repetitive Voltage Maximum	Maximum Output Voltage Drop	Off-State Leakage (mA) Maximum**	Operating Voltage Range (Volts AC)	$\rho^2 t$ Rating $t=8.3$ (ms)	Isolation Voltage	$\theta_{jc}^*$ ( $^{\circ}$ C/Watt)	Dissipation (Watts/ Amp)
120D3	120	3	85	1000	3VDC (32V allowed)	1 VDC	600	1.6 volts	2.5mA	12–140	30	4,000V <sub>RMS</sub>	11	1.7
120D10	120	10	110	1000	3VDC (32V allowed)	1 VDC	600	1.6 volts	7 mA	12–140	50	4,000V <sub>RMS</sub>	1.3	1.6
120D25	120	25	250	1000	3VDC (32V allowed)	1 VDC	600	1.6 volts	7 mA	12–140	250	4,000V <sub>RMS</sub>	1.2	1.3
120D45	120	45	650	1000	3VDC (32V allowed)	1 VDC	600	1.6 volts	7 mA	12–140	1750	4,000V <sub>RMS</sub>	0.67	0.9
240D3	240	3	85	1000	3VDC (32V allowed)	1 VDC	600	1.6 volts	5 mA	24–280	30	4,000V <sub>RMS</sub>	11	1.7
240D10	240	10	110	1000	3VDC (32V allowed)	1 VDC	600	1.6 volts	14 mA	24–280	50	4,000V <sub>RMS</sub>	1.3	1.6
240Di10	240	10	110	730	3VDC (32V allowed)	1 VDC	600	1.6 volts	14 mA	24–280	50	4,000V <sub>RMS</sub>	1.3	1.6
240D25	240	25	250	1000	3VDC (32V allowed)	1 VDC	600	1.6 volts	14 mA	24–280	250	4,000V <sub>RMS</sub>	1.2	1.3
240Di25	240	25	250	730	3VDC (32V allowed)	1 VDC	600	1.6 volts	14 mA	24–280	250	4,000V <sub>RMS</sub>	1.2	1.3
240D45	240	45	650	1000	3VDC (32V allowed)	1 VDC	600	1.6 volts	14 mA	24–280	1750	4,000V <sub>RMS</sub>	0.67	0.9
240Di45	240	45	650	730	3VDC (32V allowed)	1 VDC	600	1.6 volts	14 mA	24–280	1750	4,000V <sub>RMS</sub>	0.67	0.9
380D25	380	25	250	1000	3VDC (32V allowed)	1 VDC	800	1.6 volts	12 mA	24–420	250	4,000V <sub>RMS</sub>	1.2	1.3
380D45	380	45	650	1000	3VDC (32V allowed)	1 VDC	800	1.6 volts	12 mA	24–420	1750	4,000V <sub>RMS</sub>	0.67	0.9
120A10	120	10	110	33K	85VAC (280V allowed)	10 VAC	600	1.6 volts	7 mA	12–140	50	4,000V <sub>RMS</sub>	1.3	1.6
120A25	120	25	250	33K	85VAC (280V allowed)	10 VAC	600	1.6 volts	7 mA	12–140	250	4,000V <sub>RMS</sub>	1.2	1.3
240A10	240	10	110	33K	85VAC (280V allowed)	10 VAC	600	1.6 volts	14 mA	24–280	50	4,000V <sub>RMS</sub>	1.3	1.6
240A25	240	25	250	33K	85VAC (280V allowed)	10 VAC	600	1.6 volts	14 mA	24–280	250	4,000V <sub>RMS</sub>	1.2	1.3
240A45	240	45	650	33K	85VAC (280V allowed)	10 VAC	600	1.6 volts	14 mA	24–280	1750	4,000V <sub>RMS</sub>	0.67	0.9

Note:  $\theta_{jc}^*$  = Thermal resistance junction to base. Maximum junction temperature is 110  $^{\circ}$ C.

\*\* Operating Frequency: 25 to 65 Hz (operates at 400 Hz with 6 times the offstate leakage)

# Solid-State Relays

## AC Power Series Specifications

120/240/380 Volt (cont.)

### Surge Current Data

Time (Seconds)	Time* (Cycles)	3-Amp Peak Amps	10-Amp Peak Amps	25-Amp Peak Amps	45-Amp Peak Amps
0.017	1	85	110	250	650
0.050	3	66	85	175	420
0.100	6	53	70	140	320
0.200	12	45	60	112	245
0.500	30	37	50	80	175
1	60	31	40	67	134
2	120	28	33	53	119
3	180	27	32	49	98
4	240	26	31	47	95
5	300	25	30	45	91
10	600	24	28	42	84

Note: \*60 Hz.

### Thermal Ratings

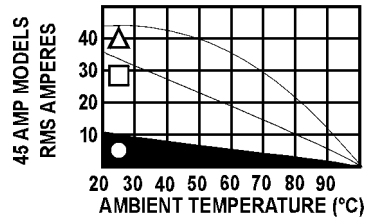
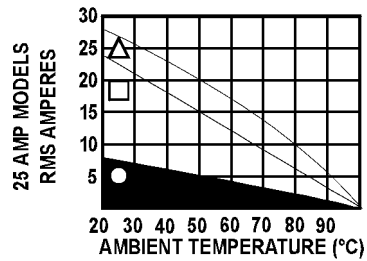
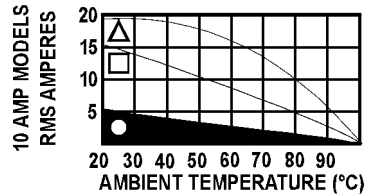
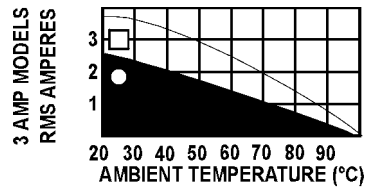

- FREE AIR
- MOUNTED ON  
6" X 6" PLATE (2°c/watt)
- MOUNTED ON  
12" X 12" PLATE (1°c/watt)

### Dimensional Drawings

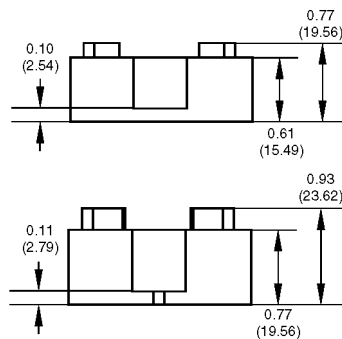
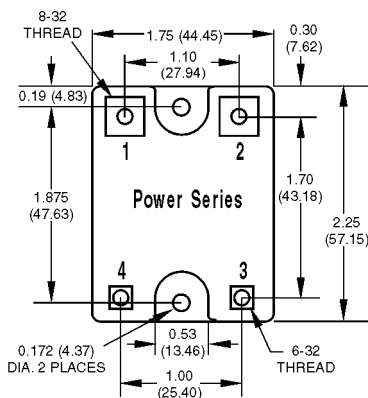

# Solid-State Relays

## AC Power Series Specifications

### 480/575 Volt

Model Number	Nominal AC Line Voltage	Nominal Current Rating (Amps)	1 cycle Surge (Amps) Peak	Nominal Signal Input Resistance (Ohms)	Signal Pick-up Voltage	Signal Drop-out Voltage	Peak Repetitive Voltage Maximum	Maximum Output Voltage Drop	Off-State Leakage (mA) Maximum**	Operating Voltage Range (Volts AC)	$I^2t$ Rating $t=8.3$ (ms)	Isolation Voltage	$\theta_{jc}^*$ (°C/Watt)	Dissipation (Watts/Amp)
480D10-12	480	10	110	1000	3VDC (32V allowed)	1 VDC	1200	3.2 volts	11 mA	100-530	50	4,000V <sub>RMS</sub>	1.2	2.5
480D15-12	480	15	150	1000	3VDC (32V allowed)	1 VDC	1200	3.2 volts	11 mA	100-530	50	4,000V <sub>RMS</sub>	1.2	2.5
480D25-12	480	25	250	1000	3VDC (32V allowed)	1 VDC	1000	1.6 volts	11 mA	100-530	250	4,000V <sub>RMS</sub>	1.3	1.3
480D45-12	480	45	650	1000	3VDC (32V allowed)	1 VDC	1000	1.6 volts	11 mA	100-530	1750	4,000V <sub>RMS</sub>	0.67	0.9
575D15-12	575	15	150	1000	3VDC (32V allowed)	1 VDC	1200	3.2 volts	15 mA	100-600	90	4,000V <sub>RMS</sub>	1.2	2.5
575D45-12	575	45	650	1000	3VDC (32V allowed)	1 VDC	1000	1.6 volts	15 mA	100-600	1750	4,000V <sub>RMS</sub>	0.67	0.9
575DI45-12	575	45	650	730	3VDC (32V allowed)	1 VDC	1000	1.6 volts	15 mA	100-600	1750	4,000V <sub>RMS</sub>	0.67	0.9

Note:  $\theta_{jc}^*$  = Thermal resistance junction to base. Maximum junction temperature is 110 °C.  
 \*\* Operating Frequency: 25 to 65 Hz (operates at 400 Hz with 6 times the offstate leakage)

### Surge Current Data

Time Second	Time*** (Cycles)	10-Amp Peak Amps	15-Amp Peak Amps	25-Amp Peak Amps	45-Amp Peak Amps
0.017	1	110	150	250	650
0.050	3	85	140	175	420
0.100	6	70	110	140	320
0.200	12	60	90	112	245
0.500	30	50	70	80	175
1	60	40	55	67	134
2	120	33	49	53	119
3	180	32	47	49	98
4	240	31	43	47	95
5	300	30	40	45	91
10	600	28	35	42	84

Note: \*\*\*60 Hz

### Thermal Ratings

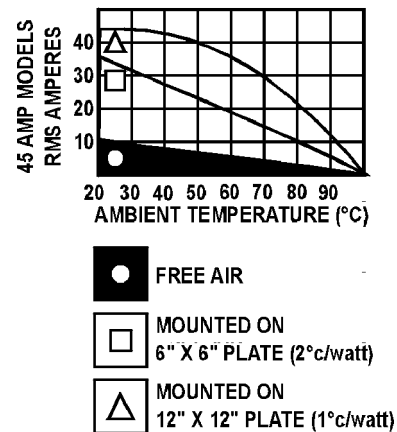

# Solid-State Relays

## AC Power Series Specifications

### 480/575 Volt (cont)

#### Dimensional Drawings

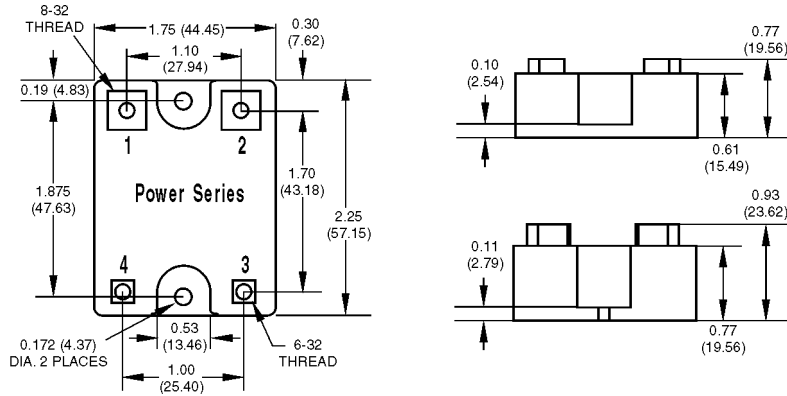

## Z Series Specifications

### AC Power: 120/240 Volt

The Z Series employs a unique heat transfer system that makes it possible for Opto 22 to deliver a low-cost, 10-amp, solid-state relay in an all-plastic case. The push-on tool-free quick-connect terminals make the Z Series ideal for high-volume OEM applications.

Model Number	Nominal AC Line Voltage	Nominal Current Rating (Amps)	1 cycle Surge (Amps) Peak	Nominal Signal Input Resistance (Ohms)	Signal Pick-up Voltage	Signal Drop-out Voltage	Peak Repetitive Voltage Maximum	Maximum Output Voltage Drop	Off-State Leakage (mA) Maximum**	Operating Voltage Range (Volts AC)	I <sub>t</sub> Rating t=8.3 (ms)	Isolation Voltage	θ <sub>jc</sub> * (°C/Watt)	Dissipation (Watts/Amp)
Z120D10	120	10	110	1000	3VDC (32V allowed)	1 VDC	600	1.6 volts	6 mA	12-140	50	4,000 V <sub>RMS</sub>	4	1
Z240D10	240	10	110	1000	3VDC (32V allowed)	1 VDC	600	1.6 volts	12 mA	24-280	50	4,000 V <sub>RMS</sub>	4	1

Notes: θ<sub>jc</sub>\* = Thermal resistance junction to base. Maximum junction temperature is 110°C.

\*\* Operating Frequency: 25 to 65 Hz (operates at 400 Hz with 6 times the offstate leakage)

# Solid-State Relays

## Z Series Specifications (cont.)

AC Power: 120/240 Volt

### Current vs. Ambient Ratings

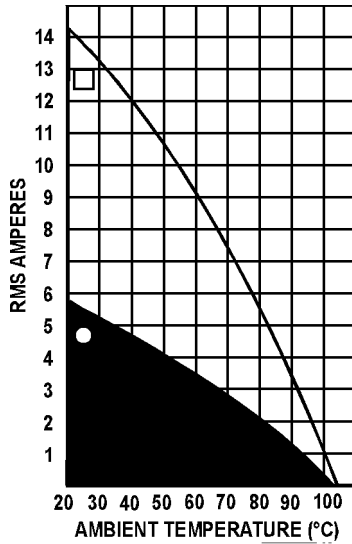

● FREE AIR  
 □ MOUNTED ON  
 6" X 6" PLATE (2°c/watt)

### Surge Current Data

Time Second	Time*** (Cycles)	Peak Amps
0.017	1	110
0.050	3	85
0.100	6	70
0.200	12	60
0.500	30	50
1	60	40
2	120	33
3	180	32
4	240	31
5	300	30
10	600	28

Note: \*\*\*60 Hz

### Dimensional Drawings

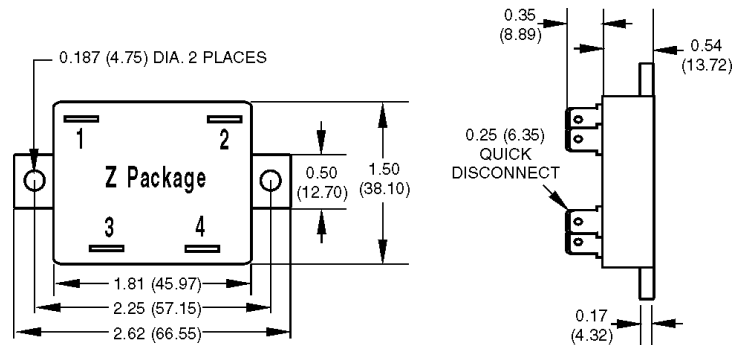

# Solid-State Relays

## Printed Circuit Series Specifications

### AC Power: MP and P Series

The MP Series packaging is designed with a minimum footprint to allow maximum relay density on the printed circuit board. The P Series power relays provide low-profile for 0.5-inch (12.7 mm) center mounting on printed circuit boards.

Model Number	Nominal AC Line Voltage	Nominal Current Rating (Amps)	1 cycle Surge (Amps) Peak	Nominal Signal Input Resistance (Ohms)	Signal Pick-up Voltage	Signal Drop-out Voltage	Peak Repetitive Voltage Maximum	Maximum Output Voltage Drop	Off-State Leakage (mA) Maximum <sup>1</sup>	Operating Voltage Range (Volts AC)	$r_{\theta}^2$ Rating t=8.3 (ms)	Isolation Voltage	$\theta_{jc}^2$ ( $^{\circ}$ C/Watt)	Dissipation (Watts/Amp)
MP120D2 or P20D2	120	3	85	1000	3VDC <sup>3</sup> (24V allowed)	1 VDC	600	1.6 volts	2.5mA	12-140	30	4,000V <sub>RM</sub> S	11	1.7
MP120D4 or P120D4	120	10	110	1000	3VDC <sup>3</sup> (24V allowed)	1 VDC	600	1.6 volts	7 mA	12-140	50	4,000V <sub>RM</sub> S	1.3	1.6
MP240D2 or P240D2	120	25	250	1000	3VDC <sup>3</sup> (24V allowed)	1 VDC	600	1.6 volts	7 mA	12-140	250	4,000V <sub>RM</sub> S	1.2	1.3
MP240D4 or P240D4	120	45	650	1000	3VDC <sup>3</sup> (24V allowed)	1 VDC	600	1.6 volts	7 mA	12-140	1750	4,000V <sub>RM</sub> S	0.67	0.9
MP380D4	120	45	650	1000	3VDC <sup>3</sup> (24V allowed)	1 VDC	600	1.6 volts	7 mA	12-140	1750	4,000V <sub>RM</sub> S	0.67	0.9

1) Operating Frequency: 25 to 65 Hz (operates at 400 Hz with 6 times the offstate leakage)  
 2)  $\theta_{jc}^2$  = thermal resistance junction to base. Maximum junction temperature is 110  $^{\circ}$ C.  
 3) P Series: 32 V maximum

### Surge Current Data

Time Second	Time* (Cycles)	Peak Amps	Peak Amps
0.017	1	20	85
0.050	3	18	66
0.100	6	15	53
0.200	12	11	45
0.500	30	9	37
1	60	8.5	31
2	120	8	28
3	180	7.5	27
4	240	7	26
5	300	6.5	25
10	600	6	24

Note: \*60 Hz

### Dimensional Drawings

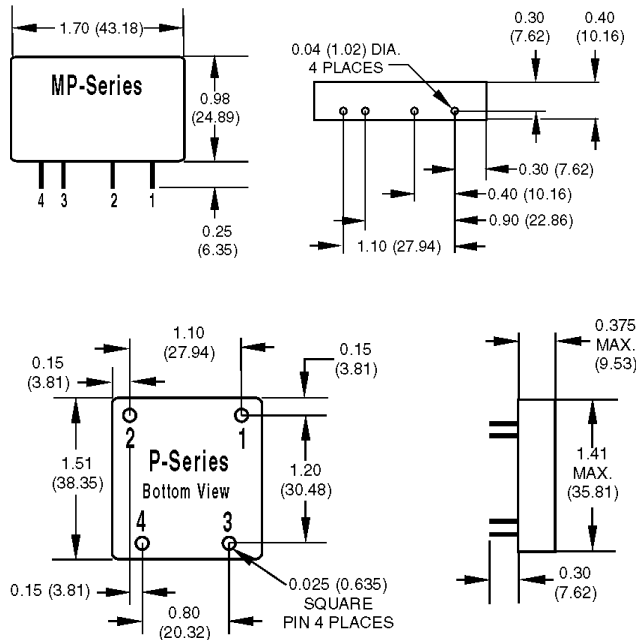



# Solid-State Relays

## Printed Circuit Series (cont.)

### AC Power: P and MP Series (cont.)

#### Thermal Ratings

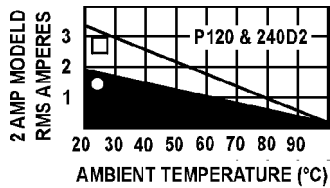
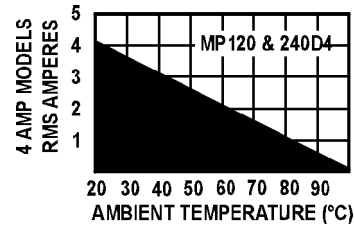
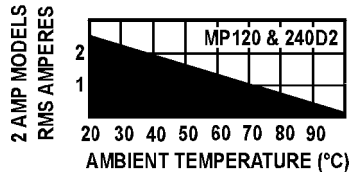

#### Surge Current Data

Time Second	Time* (Cycles)	Peak Amps	Peak Amps
0.017	1	20	85
0.050	3	18	66
0.100	6	15	53
0.200	12	11	45
0.500	30	9	37
1	60	8.5	31
2	120	8	28
3	180	7.5	27
4	240	7	26
5	300	6.5	25
10	600	6	24

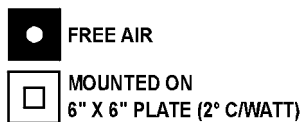
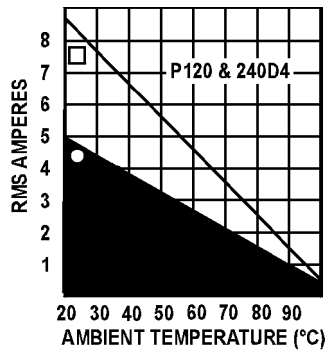

Note: \*60 Hz

## DC Switching Series Specifications

	DC60P or DC60MP	DC200P or DC200MP	DC60S-3	DC60S-5
Operating Voltage Range	5-60 VDC	5-200 VDC	5-60 VDC	5-60 VDC
Forward Voltage Drop	1.5 volts	1.5 volts at 1 amp	1.5 volts at 3 amps	1.5 volts at 5 amps
Nominal Current Rating	3 amps	1 amp	3 amps	5 amps
Off-State Blocking	60 VDC	250 VDC	60 VDC	60 VDC
Signal Pickup Voltage	3 VDC 32 Volts* allowed	3 VDC 32 Volts* allowed	3 VDC 32 Volts allowed	3 VDC 32 Volts allowed
Signal Dropout Voltage	1 VDC	1 VDC	1 VDC	1 VDC
Signal Input Impedance	1,000 ohms	1,000 ohms	1,000 ohms	1,000 ohms
1 Second Surge	5 amps	2 amps	5 amps	10 amps
Operating Temp. Range	-40° C to 100° C	-40° C to 100° C	-40° C to 100° C	-40° C to 100° C
Isolation Voltage	4,000 V <sub>RMS</sub>	4,000 V <sub>RMS</sub>	4,000 V <sub>RMS</sub>	4,000 V <sub>RMS</sub>
Off-state Leakage	1 mA maximum	1 mA maximum	1 mA maximum	1 mA maximum
Package Type	P/MP series	P/MP series	Power series	Power series
Turn-On Time	100 μsec	100 μsec	100 μsec	100 μsec
Turn-Off Time	750 μsec	750 μsec	750 μsec	750 μsec

Note: \*MP series maximum allowed control signal 24 VDC.

## Solid-State Relays

### Thermal Ratings

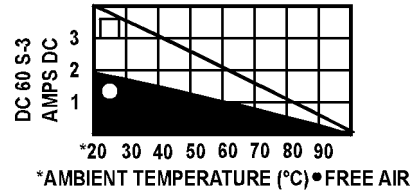
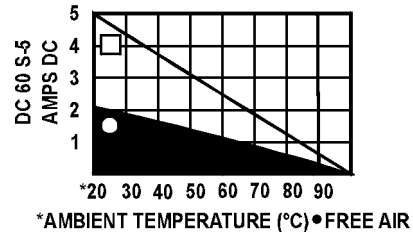
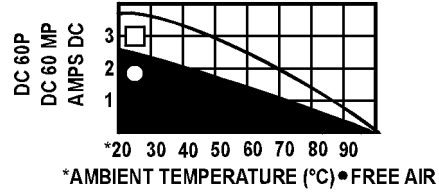
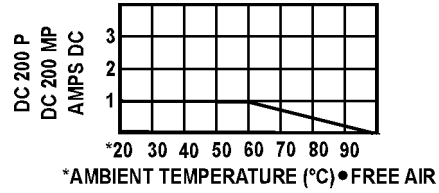

# Solid-State Relays

## Dimensional Drawings

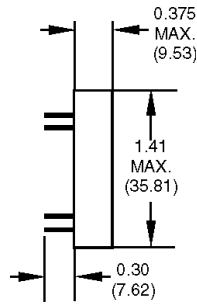
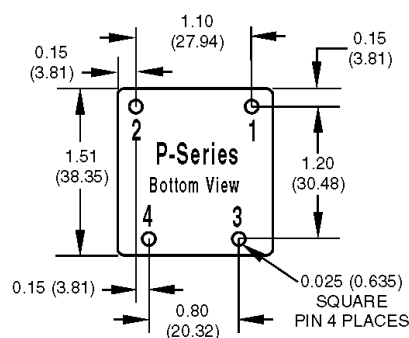
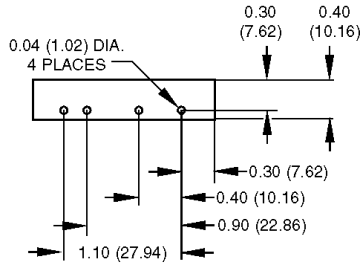
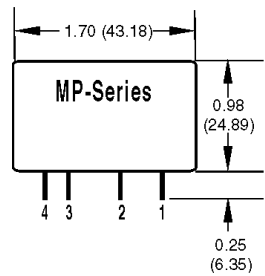
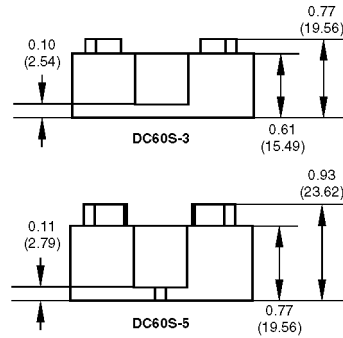
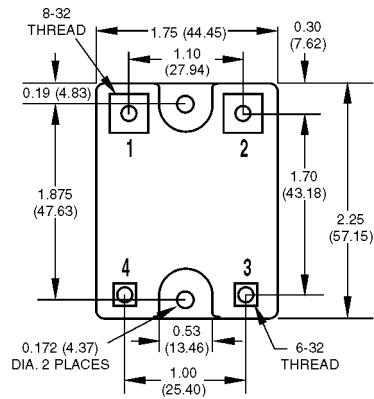

## Solid-State Relays

### Applications: Tips

#### Heat Sink Calculation

Like all semiconductor devices, SSR current ratings must be based on maximum junction temperature. All Opto 22 SSRs operate conservatively at maximum junction temperatures of 110 °C. Determining an adequate heat sink for a given SSR conducting a given current is very simple.

**IMPORTANT: Thermally conductive grease must be used between the relay base and the heat sink.**

#### Sample Calculation

120-volt, 20-amp load; 50 °C ambient air

Choose model 120D25 SSR.

Calculate dissipation as: **20 amps x 1.3 watts per amp = 26 watts**

Calculate temperature rise junction to SSR base as: **26 Watts x 1.2 °C per Watt = 31.2 °C**

Calculate allowable temperature of heat sink by subtracting 31.2 °C from 110 °C allowable junction temperature:

$$110\text{ °C} - 31.2 = 78.8\text{ °C}$$

The heat sink is in a 50 °C ambient, therefore, allowable temperature rise on heat sink is: **78.8 °C – 50 °C = 28.8 °C**

If heat sink is allowed to rise 28.8 °C above ambient, then the thermal resistance of the heat sink is simply the 28.8 °C rise divided by the 26 watts. Any heat sink having a thermal resistance less than 1.1 °C per watt will be adequate.

#### Duty Cycle Calculation

When solid-state relays are operated in an on/off mode, it may be advantageous to calculate the RMS value of the current through the SSR for heat sinking or determining the proper current rating of the SSR for the given application.

$I_{RMS}$  = RMS value of load or SSR

$T_1$  = Time current is on

$T_2$  = Time current is off

$I_{ON}$  = RMS value of load current during on period

$$I_{RMS} = \sqrt{\frac{(I_{ON})^2 \times T_1}{T_1 + T_2}}$$

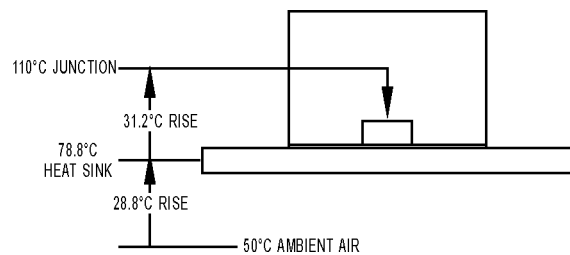

# Solid-State Relays

## Applications: Tips (cont.)

### Transformer Loads

Careful consideration should be given to the selection of the proper SSR for driving a given transformer. Transformers are driven from positive saturation of the iron core to negative saturation of the core each half cycle of the alternating voltage. Large inrush currents can occur during the first half cycle of line voltage if a zero-voltage SSR happens to turn on during the positive half cycle of voltage when the core is already in positive saturation. Inrush currents greater than 10 times rated transformer current can easily occur. The following table provides a guide for selecting the proper SSR for a given transformer rating.

120-Volt Transformers	
SSR MODEL	TRANSFORMER
P or MP 120D2	100 VA
Z120D10	500 VA
120D3	100 VA
P or MP 120D4	250 VA
120D10 or 120A10	500 VA
120D25 or 120A25	1 KVA
120D45	2 KVA
240-Volt Transformers	
P or MP240D2	200 VA
7240D10	1 KVA
120D3	200 VA
P or MP240D4	500 VA
240D10 or 240A10	1 KVA
240D25 or 240A25	2 KVA
240D45	4 KVA
480-Volt Transformers	
SSR MODEL	TRANSFORMER
480D10-12	5-Amp Primary
480D15-12	5-Amp Primary

### Solenoid Valve and Contactor Loads

All Opto 22 SSRs are designed to drive inductive loads such as solenoid valves and electromechanical contactors. The built-in snubber in each SSR assures proper operation into inductive loads. The following table is a guide in selecting an SSR to drive a solenoid or contactor.

120-Volt Coils		
SSR CURRENT RATING	SOLENOID	CONTACTOR
2-Amp	1-Amp	NEMA Size 4
4-Amp	3-Amp	NEMA Size 7
240-Volt Coils		
SSR CURRENT RATING	SOLENOID	CONTACTOR
2-Amp	1-Amp	NEMA Size 7
4-Amp	3-Amp	NEMA Size 7

### Control Current Calculation

All Opto 22 DC-controlled SSRs have a control circuit consisting of 1000 ohms in series with an LED. Since 3 volts is required to turn on any SSR, the maximum current required is (3 volt - 1 volt) divided by 1000 ohms, which equals 2.0 mA. The 1 volt is subtracted from the 3 volt signal because 1 volt is dropped across the LED. For higher control voltages, an external resistor can be added in series with the control voltage to limit the control current. To limit the control current to 2 mA, calculate the external resistor  $R_c = 500 (E_c - 3)$  where  $E_c$  = the control voltage.

The DC control voltage range is 3–32 VDC. To calculate the control current for any voltage within the 3–32 VDC range, use the formula:

$$I_c = \frac{E_c - 1}{1000}$$

where  $R_c = \text{zero}$ .

With a 5V control signal,

$$I_c = \frac{5 - 1}{1000} = 4 \text{ mA}$$

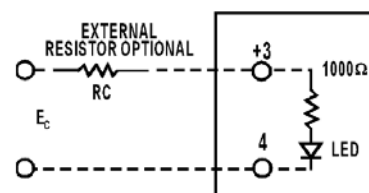

## Applications: Tips (cont.)

Opto 22 SSRs for controlling single-phase motors are shown in the following tables:

120-Volt Single-Phase Non-Reversing Motors	
SSR Model	MOTOR RATING
P or MP120D2	1 Amp
Z120D10	1/4 HP
120D3	1-1/2 Amp
P or MP120D4	1-1/2 Amp
120D10 or 120A10	1/4 HP
120D25 or 120A25	1/3 HP
120D45	3/4 HP

240-Volt Single Phase Non-Reversing Motors	
SSR Model	MOTOR RATING
P or MP240D2	1 Amp
Z240D10	1/4 HP
240D3	1-1/2 Amp
P or MP240D4	1-1/2 Amp
240D10 or 240A10	1/3 HP
240D25 or 120A25	1/2 HP
240D45	1-1/2 HP

120-Volt Single-Phase Reversing Motors	
SSR Model	MOTOR RATING
P or MP240D2	1 Amp
Z240D10	1/4 HP
240D3	1-1/2 Amp
P or MP240D4	1-1/2 Amp
240D10 or 240A10	1/4 HP
240D25 or 120A25	1/3 HP
240D45	3/4 HP

## Solid-State Relays

240-Volt Single-Phase Reversing Motors	
SSR Model	MOTOR RATING
480D10-12	1/4 HP
480D15-12	1/4 HP

### Solid-State Relays in Series

In applications requiring greater current rating at higher voltage, two Opto 22 SSRs may be operated in series for double the voltage rating. The built-in snubber in each SSR assures proper voltage sharing of the two SSRs in series. In the following diagram, two 240-volt, 45-amp SSRs are connected in series for operation on a 480-volt line. The control is shown with a parallel hook-up but it should be noted that a serial connection can also be implemented.

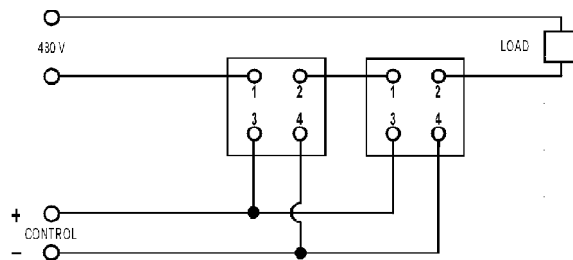

### Lamp Loads

Since all Opto 22 SSRs are zero-voltage switching, they are ideal for driving incandescent lamps, because the initial inrush current into a cold filament is reduced. The life of the lamp is increased when switched by a zero-voltage turn-on SSR. The following table is a guide to selecting an Opto 22 SSR for switching a given incandescent lamp.

120 Volt Lamps	
SSR CURRENT RATING	LAMP RATING
2-Amp	100 Watt
4-Amp	400 Watt
10-Amp	1 Kilowatt
25-Amp	2 Kilowatt
45-Amp	3 Kilowatt
240 Volt Rating	
SSR CURRENT RATING	LAMP RATING
2-Amp	200 Watt
4-Amp	800 Watt
10-Amp	2 Kilowatt
25-Amp	4 Kilowatt
45-Amp	6 Kilowatt

# Solid-State Relays

## Applications: Tips (cont.)

### Heater Loads

Care should be taken in selecting a SSR for driving a heater load if the load is cycled on and off in a continuous manner as might occur in a temperature control application. Constant cycling can cause thermal fatigue in the thyristor chip at the point where the chip bonds to the lead frame. Opto 22 employs a thick copper lead frame for mounting the SCR chips in the power series SSRs to eliminate thermal fatigue failures. In addition, Opto 22 recommends operating any SSR at 75% rated current for cycling heater loads to ensure complete reliability.

The following table is a guide to selecting the proper SSR for a given heater load.

Nominal SSR Current Rating	Maximum Recommended Heater Current
2-Amp	1½-Amp
4-Amp	2½-Amp
10-Amp	7½-Amp
25-Amp	18-Amp
45-Amp	35-Amp
10 480V	8-Amp
10 480V	8-Amp

### Single-Phase Reversing Motor Control

The circuit diagram below illustrates a typical 1 Ø motor winding inductance and the phase shift capacitor can cause twice-line voltage to appear across the open SSR. A 240-volt SSR should be used for a 120-volt line. During the transition period when one SSR is turned on and the other SSR is going off, both SSRs may be on. In this case, the capacitor may discharge through the two SSRs, causing large currents to flow, which may destroy the SSRs. The addition of RL as shown will protect the SSRs from the short circuit capacitor discharge current.

$$\text{CALCULATE RL as: } RL = \frac{1.4 \text{ EAC}}{10 \times \text{SSR full load rating}}$$

**EXAMPLE: 10 amp SSR  
120 V AC Line**

$$RL = \frac{1.4 \times 120}{10 \times 10} = 1.7 \text{ ohm}$$

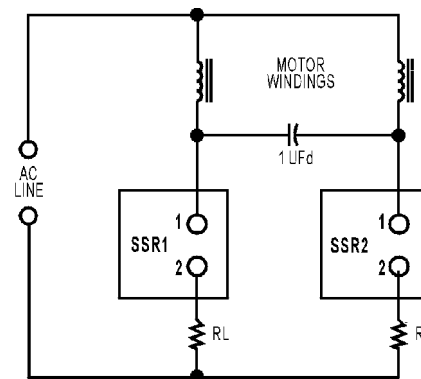

The resistors are unnecessary if the control circuit is designed to ensure that one SSR is off before the other SSR is on.

**Applications: Tips (cont.)**

**Three-Phase Motor Control**

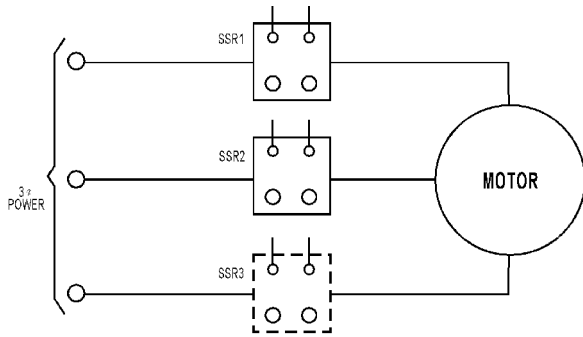

Three-phase motors may be controlled by solid-state relays as shown. A third SSR as shown is optional, but not necessary. The control windings may be connected in series or parallel. Care should be taken to ensure that the surge current drawn by the motor does not exceed the surge current rating of the SSR.

240 Volt Three-Phase Motor	
SSR MODEL	MOTOR
Z240D25	1/3 HP
Z240D10	3/4 HP
240D10	3/4 HP
240A10	3/4 HP
240D25	2 HP
240A25	2 HP
240D45	3 HP
480 Volt Three-Phase Motors	
SSR MODEL	MOTOR
480D10-12	1-½ HP
480D15-12	1-½ HP

**Solid-State Relays**

**Three-Phase Reversing Motor Control**

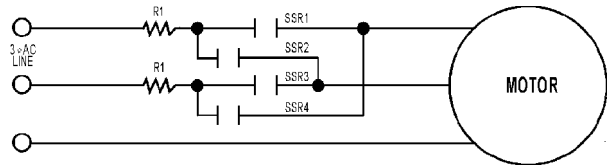

Three-phase reversing motor control can be implemented with four SSRs as shown in the connection diagram. The SSRs work in pairs with SSR1 and SSR3 operated for rotation in one direction and SSR2 and SSR4 operated for rotation in the reverse direction. The resistor R1 as shown in the connection diagram protects against line-to-line shorts if SSR1 and SSR4 or SSR3 and SSR2 are on at the same time during the reversing transition period. Use the following table as a guide to the proper selection of an SSR for this application.

Opto 22 Relay	Motor Full Load Rating	Resistor for 120V line	Resistor for 240V line
3-Amp	1.25-Amp	4 ohm 50 W	8 ohm 50 W
10-Amp	5-Amp	1 ohm 100 W	2 ohm 100 W
25-Amp	8-Amp	.5 ohm 100 W	1 ohm 100 W
45-Amp	16-Amp	.25 ohm 150 W	.5 ohm 150 W
15-Amp	5-Amp	1 ohm 100 W	2 ohm 100 W



# Solid-State Relays

## FAQ: SSR Applications

### Q : What is a solid-state relay?

**A:** A solid-state relay (SSR) is a semiconductor device that can be used in place of a mechanical relay to switch electricity to a load in many applications. Solid-state relays are purely electronic, normally composed of a low current “control” side (equivalent to the coil on an electromechanical relay) and a high-current load side (equivalent to the contact on a conventional relay). SSRs typically also feature electrical isolation to several thousand volts between the control and load sides. Because of this isolation, the load side of the relay is actually powered by the switched line; both line voltage and a load (not to mention a control signal) must be present for the relay to operate.

### Q : What are the advantages of using an SSR over a mechanical relay?

**A:** There are many applications that require a moderate amount of power (W to kW) to be switched on and off fairly rapidly. A good example would be the operation of a heater element in a controlled-temperature system. Typically, the amount of heat put into the system is regulated using pulse-width modulation turning a fixed-power heating element on and off for time periods ranging from seconds to minutes. Mechanical relays have a finite cycle life, as their components tend to wear out over thousands to millions of cycles. SSRs do not have this problem; in the proper application, they could be operated almost infinitely.

### Q : What are the limitations of using an SSR?

**A:** SSRs have a few limitations when compared to the capabilities of their mechanical counterparts. First, because the relay is semiconductor-based, it will never turn all the way on, nor off. This means that in the “on” state, the relay still has some internal resistance to the flow of electricity, causing it to get hot. When in the “off” state, the relay will exhibit a small amount of leakage current, typically a few mA. This leakage can conspire to keep some loads, especially ones with a high impedance, from turning off! Additionally, SSRs are more sensitive to voltage transients; while Opto 22 relays are very well transient-protected, if a relay gets hit hard enough a sufficient number of times, it will die or degrade. This makes SSRs less ideal for driving highly inductive electromechanical loads, such as some solenoids or motors. SSRs should also never be used for applications such as safety power disconnects, because even in the off state, leakage current is present. Leakage current through an SSR also implies the presence of a potentially high voltage. Even though the relay is not conducting a large amount of current, the switched terminal will still be “hot,” and thus dangerous.

### Q : Do you make multi-pole or multi-throw SSRs?

**A:** Opto 22 manufactures only single-pole, single-throw SSRs. If multi-phase operation is required, just use a relay on each phase. Because of the limitations on semiconductor devices of the type used in SSRs, it is not practical to build single-device multi-throw SSRs. However, an alternative to multi-throw operation may be accomplished with multiple relays.

### Q : Can I hook up SSRs in parallel to achieve a higher current rating?

**A:** No. There is no way to guarantee that two or more relays will turn on simultaneously when operated in parallel. Each relay requires a minimum voltage across the output terminals to function; because of the optical isolation feature, the “contact” part of the SSR is actually powered by the line it switches. One relay turning on before the other will cause the second relay to lose its turn-on voltage, and it won't ever turn on, or at least not until the first relay fails from carrying too much current.

### Q : What does a “zero-crossing” turn-on circuit refer to?

**A:** “Zero-crossing” turn-on and turn-off refer to the point on the AC wave form when the voltage is zero. It is at this point that an AC SSR will turn on or off. All Opto 22 AC relays are designed with a zero-crossing turn-on and turn-off circuit. When the AC circuit voltage is at zero, no current is flowing. This makes it much easier and safer for the semiconductor device in the relay to be turned on or off. It also generates much less electrical EMI/RFI noise.

### Q : Can I use an AC SSR to switch DC?

**A:** No. Because of the zero-crossing circuit described above, the relay will most likely never turn on, and even if it is on, it will likely not be able to be turned off, as DC voltage typically never drops to zero.

### Q : Can I use a DC SSR to switch AC?

**A:** No. The semiconductor device used in Opto 22's DC SSRs is polarized. It may break down and conduct for the portion of the waveform that is reversed in polarity.

### Q : Can a DC SSR be used to switch an analog signal?

**A:** This is not recommended at all. First, the voltage drop across the relay will cause signal loss. Second, the conduction characteristics of the SSR are very non-linear at low operating voltages and currents. Use a mechanical relay; it will work much better.

**Q : What agency approvals do your SSRs carry?**

**A:** In general, Opto 22 relays carry UL, CSA, and CE approval. See <http://support.opto22.com>. Additionally, some SSRs contain VDE-approved optocouplers; contact Opto 22 for more information.

\*UL recognition is pending for Power Series SSRs with LED indicators. Contact Opto 22 Product Support for current UL information.

**FAQ: SSR Troubleshooting****Q : My SSR does not function anymore. What may have happened?**

**A:** There is no “normal” mode of failure for SSRs. They just stop working, by refusing to turn on or off. An improper installation is often to blame for an SSR failure, as these are very simple, reliable devices. If you have a failed SSR, it is important to look at the normal operating parameters of that relay within the larger system to make sure that the relay being used is appropriate to the application, and that the relay is being properly installed in the system. The three most common causes of SSR failure are as follows:

- **SSR improperly matched to load.** The relay was destroyed by overheating from carrying too much current too long.
- **SSR insufficiently protected.** Remember, a semiconductor is less tough than a simple metal contact. Reverse voltages exceeding the PRV rating of the relay will cause damage. Voltage spikes on the switched line, perhaps from inductive kick-back, may have destroyed one or more of the internal switching devices. Remember to use snubbers, transorbs, MOVs, and/or commutating diodes on highly inductive loads.
- **SSR improperly installed.** The SSR was not mounted to a large enough heat sink, or no thermal compound was used, causing the relay to overheat. Also, insufficient tightening of the load terminals can cause arcing and ohmic heating of the relay. Opto 22 recommends 15 to 16 inch-pounds of torque on the load screw terminals. Similar failures have also been attributed to the use of crimp-on terminal lugs or spades; make sure such terminals are tightly crimped, and even drip some solder into the joint to ensure good electrical contact and protection from corrosion.

**Q : How can I test my SSR?**

**A:** It is not possible to test an SSR by the same methods used to test mechanical relays; a typical SSR will always show an infinite impedance to a resistance meter placed across the output terminals. There are a few reasons for this. First, the SSR requires a small amount of power to operate, derived from whatever voltage source is placed on the load terminals. A typical multimeter will not supply sufficient voltage to cause the relay to change state. Second,

## Solid-State Relays

AC SSRs contain a zero-crossing circuit, which will not allow them to change state unless zero voltage is applied. Most test equipment will supply a DC voltage to the relay, and the relay will thus never see the zero it requires to change state. To test an SSR, it is best to operate it at the actual line voltage it will be used at, driving a load such as a large light bulb.

**Q : I have an SSR driving a load. The load turns on okay, but never seems to turn off, unless I remove power from the relay entirely. What might be happening?**

**A:** This is normally a problem when using an SSR with a high-impedance load, such as a neon lamp or a small solenoid. Loads like these often have relatively large initial currents, but relatively small “hold in” currents. The result is that the off-state leakage current through the relay (see previous section) is insufficient to cause the load to turn on to start with, but sufficient to keep it on, once started. The solution is to place a power resistor, sized for 8–10 times the rated maximum leakage current for the SSR in parallel with the load. Make sure that this resistor has a high enough power rating for the application. For example, for a 5 mA leakage current at 120 VAC, a resistor drawing 50 mA would be desirable. Using Ohm’s Law, the resistor value becomes 2,400 ohms. This resistor will dissipate 6 watts, so a 7.5 or 10-watt size power resistor should be used.

**Q : I have a new AC SSR driving a solenoid. It turns on okay once, but will not turn on again. What is going on?**

**A:** Some solenoids, some types of halogen lights, and some types of strobe lights incorporate a diode in series with the coil or filament. This causes the light to behave as a half-wave rectifier. Opto 22 SSRs have a built-in R-C snubber circuit in parallel with the output. The capacitor in this circuit charges up but cannot discharge through the series diode, causing a voltage to appear across the SSR terminals. Because the SSR must see a zero voltage across the terminals to come on, it can’t turn on again in this situation. The solution here would be to put a high-value resistor (several tens of Kohms) across the terminals of the relay, to allow the capacitor to drain its charge.