

SIDE VIEW OF BOX

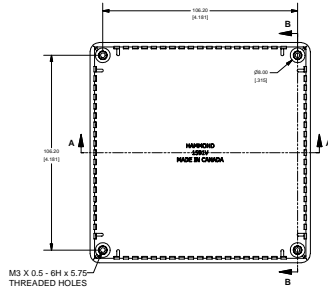

SECTION A-A  
SCALE 3/4

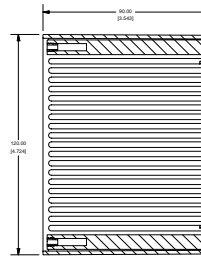

SECTION B-B  
SCALE 3/4

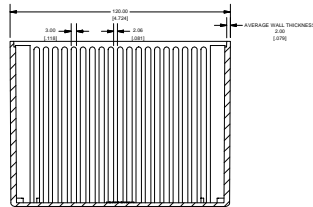

SECTION A-A  
SCALE 3/4

1591V

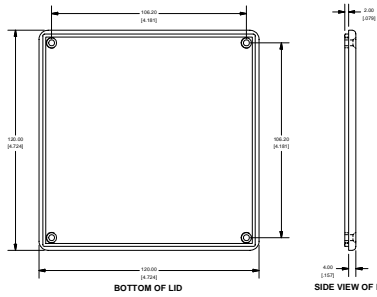
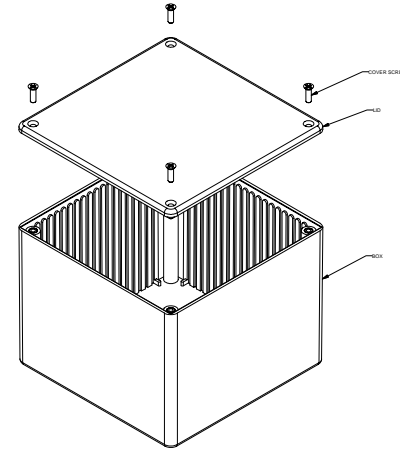

BOTTOM OF LID

SIDE VIEW OF LID

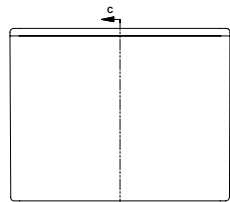

END VIEW OF ASSEMBLY

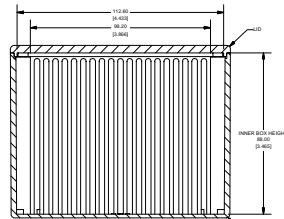

SECTION C-C  
SCALE 3/4

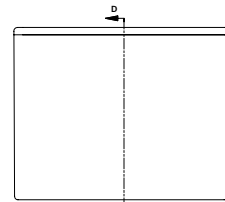

SIDE VIEW OF ASSEMBLY

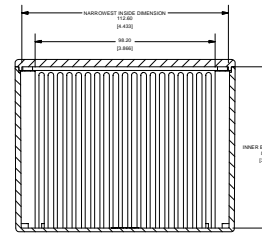

SECTION D-D  
SCALE 3/4

PART NUMBERS		
1591V Enclosures		
Material	Colour	Part Number
ABS	Black	1591VBC
	Blue	1591VBU
	Grey	1591VGY
	Black Shielded	1591RVBK
GP ABS	Black	1591VSBK
	Ice Blue	1591VBU
Polycarbonate	IR Red	1591VTRD
	Crystal Clear	1591VTCL
Accessories		
	Description	Part Number
Used with ABS and Polycarbonate Enclosures	PC Board Card Adapters	See Accessories Section
	Flange Kits	See Accessories Section
	Replacement Screws, nickel plated M3 - 0.5 x 10mm, Pack of 100	1591MS100
	Belt/Pocket Clip, w/ nylon screws (insulated to avoid interference) and mounting template	1591MS100BK (Black)
	Clear Lids - clear, flame retardant polycarbonate - Lid ONLY	1599CLIPGY - Grey
	Clear Lids - clear, flame retardant polycarbonate - Lid ONLY	1591VCL
	PC Board Card Adapters	See Accessories Section
	Flange Kits	See Accessories Section
	Belt/Pocket Clip, w/ nylon screws (insulated to avoid interference) and mounting template	1599CLIP - Black
	Replacement Screws, self tapping, black oxide, #4 x 0.5, Pack of 100	1591TS100BK
Used with GP ABS Enclosure	Clear Lids - clear, flame retardant polycarbonate - Lid ONLY	1591VCL
	Clear Lids - clear, flame retardant polycarbonate - Lid ONLY	1591VCL
Required Torques for Fasteners and Lubrication		
	M3 - 0.5 x 10mm Screws	30-40 cN/m
	#4 x 0.5 Screws	30-40 cN/m

