

T-33-31

2N6029 thru 2N6031
See Page 3-105

T-33-29

MOTOROLA SEMICONDUCTOR TECHNICAL DATA

PNP	NPN
2N6034	2N6037
2N6035	2N6038
2N6036	2N6039

PLASTIC DARLINGTON COMPLEMENTARY SILICON POWER TRANSISTORS

... designed for general-purpose amplifier and low-speed switching applications.

- High DC Current Gain —
hFE = 2000 (Typ) @ IC = 2.0 Adc
- Collector-Emitter Sustaining Voltage — @ 100 mAdc
VCEO(sus) = 40 Vdc (Min) — 2N6034, 2N6037
= 60 Vdc (Min) — 2N6035, 2N6038
= 80 Vdc (Min) — 2N6036, 2N6039
- Forward Biased Second Breakdown Current Capability
IS/b = 1.5 Adc @ 25 Vdc
- Monolithic Construction with Built-In Base-Emitter Resistors to Limit Leakage Multiplication
- Space-Saving High Performance-to-Cost Ratio
TO-225AA Plastic Package

DARLINGTON 4-AMPERE COMPLEMENTARY SILICON POWER TRANSISTORS

40, 60, 80 VOLTS
40 WATTS

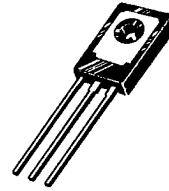

***MAXIMUM RATINGS**

Rating	Symbol	2N6034 2N6037	2N6035 2N6038	2N6036 2N6039	Unit
Collector-Emitter Voltage	VCE0	40	60	80	Vdc
Collector-Base Voltage	VCB	40	60	80	Vdc
Emitter-Base Voltage	VEB	8.0			Vdc
Collector Current — Continuous	IC	4.0			A dc
Collector Current — Peak	IC	8.0			A dc
Base Current	IB	100			mAdc
Total Power Dissipation @ TC = 25°C	PD	40			Watts
Derate above 25°C	PD	0.32			W/°C
Total Power Dissipation @ TA = 25°C	PD	1.5			Watts
Derate above 25°C	PD	0.012			W/°C
Operating and Storage Junction Temperature Range	TJ, Tstg	-65 to +150			°C

THERMAL CHARACTERISTICS

Characteristic	Symbol	Max	Unit
Thermal Resistance, Junction to Case	θ_{JC}	3.12	°C/W
Thermal Resistance, Junction to Ambient	θ_{JA}	83.3	°C/W

*Indicates JEDEC Registered Data.

FIGURE 1 — POWER DERATING

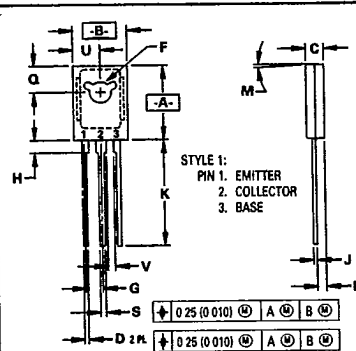
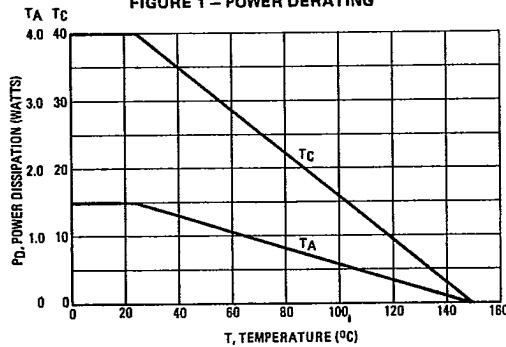

- NOTES:
1. DIMENSIONING AND TOLERANCING PER ANSI Y14.5M, 1982.
2. CONTROLLING DIMENSION: INCH.

DIM	MILLIMETERS		INCHES	
	MIN	MAX	MIN	MAX
A	10.80	11.04	0.425	0.435
B	7.50	7.74	0.295	0.305
C	2.42	2.66	0.095	0.105
D	0.51	0.66	0.020	0.026
F	2.93	3.17	0.115	0.125
G	2.39 BSC		0.094 BSC	
H	1.27	2.41	0.050	0.095
J	0.39	0.63	0.015	0.025
K	14.61	16.63	0.575	0.655
M	3° TYP		3° TYP	
Q	3.76	4.01	0.148	0.158
R	1.15	1.39	0.045	0.055
S	0.64	0.88	0.025	0.035
U	3.69	3.93	0.145	0.155
V	1.02	—	0.040	—

**CASE 77-06
TO-225AA TYPE**

3

2N6034, 2N6035, 2N6036 PNP
2N6037, 2N6038, 2N6039 NPN

T-33-31

T-33-29

*ELECTRICAL CHARACTERISTICS (T_C = 25°C unless otherwise noted)

Characteristic	Symbol	Min	Max	Unit
OFF CHARACTERISTICS				
Collector-Emitter Sustaining Voltage (I _C = 100 mA, I _B = 0)	V _{CEO(sus)}	40 60 80	— — —	Vdc
Collector-Cutoff Current (V _{CE} = 40 Vdc, I _B = 0) (V _{CE} = 60 Vdc, I _B = 0) (V _{CE} = 80 Vdc, I _B = 0)	I _{CEO}	— — —	100 100 100	μA
Collector Cutoff Current (V _{CE} = 40 Vdc, V _{BE(off)} = 1.5 Vdc) (V _{CE} = 60 Vdc, V _{BE(off)} = 1.5 Vdc) (V _{CE} = 80 Vdc, V _{BE(off)} = 1.5 Vdc) (V _{CE} = 40 Vdc, V _{BE(off)} = 1.5 Vdc T _C = 125°C) (V _{CE} = 60 Vdc, V _{BE(off)} = 1.5 Vdc T _C = 125°C) (V _{CE} = 80 Vdc, V _{BE(off)} = 1.5 Vdc T _C = 125°C)	I _{CEX}	— — — — — —	100 100 100 500 500 500	μA
Collector Cutoff Current (V _{CB} = 40 Vdc, I _E = 0) (V _{CB} = 60 Vdc, I _E = 0) (V _{CB} = 80 Vdc, I _E = 0)	I _{CB0}	— — —	0.5 0.5 0.5	mA
Emitter Cutoff Current (V _{BE} = 5.0 Vdc, I _C = 0)	I _{EBO}	—	2.0	mA
ON CHARACTERISTICS				
DC Current Gain (I _C = 0.5 A, V _{CE} = 3.0 Vdc) (I _C = 2.0 A, V _{CE} = 3.0 Vdc) (I _C = 4.0 A, V _{CE} = 3.0 Vdc)	h _{FE}	500 750 100	— 15,000 —	—
Collector-Emitter Saturation Voltage (I _C = 2.0 A, I _B = 8.0 mA) (I _C = 4.0 A, I _B = 40 mA)	V _{CE(sat)}	— —	2.0 3.0	Vdc
Base-Emitter Saturation Voltage (I _C = 4.0 A, I _B = 40 mA)	V _{BE(sat)}	—	4.0	Vdc
Base-Emitter On Voltage (I _C = 2.0 A, V _{CE} = 3.0 Vdc)	V _{BE(on)}	—	2.8	Vdc
DYNAMIC CHARACTERISTICS				
Small-Signal Current-Gain (I _C = 0.75 A, V _{CE} = 10 Vdc, f = 1.0 MHz)	h _{fe}	25	—	—
Output Capacitance (V _{CB} = 10 Vdc, I _E = 0, f = 0.1 MHz)	C _{ob}	— —	200 100	pF

*Indicates JEDEC Registered Data.

FIGURE 2 - SWITCHING TIMES TEST CIRCUIT

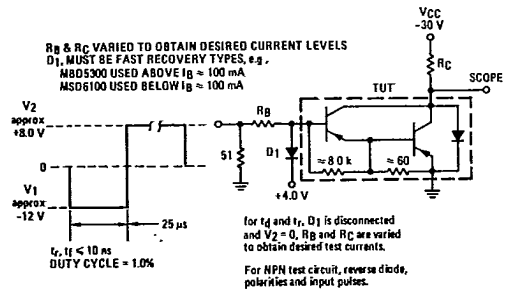
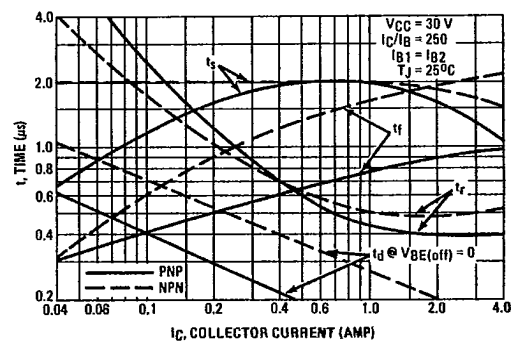

FIGURE 3 - SWITCHING TIMES



2N6034, 2N6035, 2N6036 PNP
2N6037, 2N6038, 2N6039 NPN

T-33-31

T-33-29

FIGURE 4 - THERMAL RESPONSE

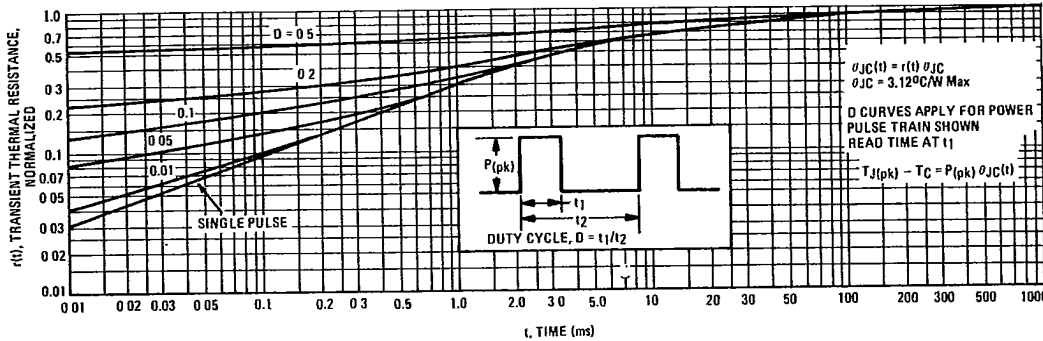

ACTIVE-REGION SAFE-OPERATING AREA

FIGURE 5 - 2N6034, 2N6035, 2N6036

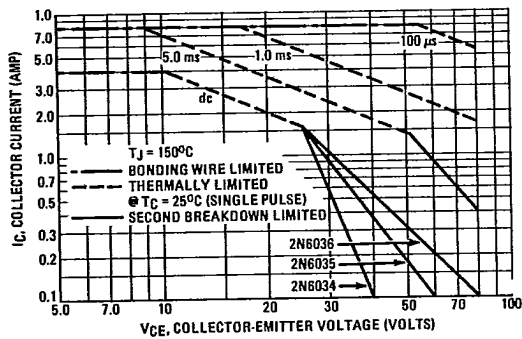
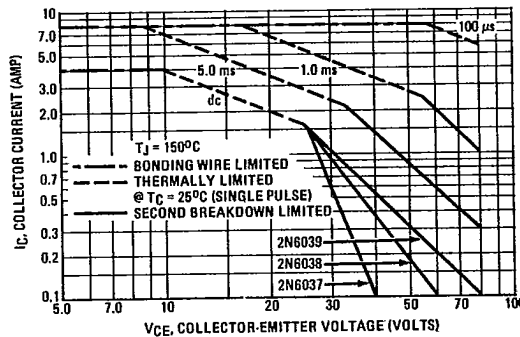

FIGURE 6 - 2N6037, 2N6038, 2N6039



3

There are two limitations on the power handling ability of a transistor: average junction temperature and second breakdown. Safe operating area curves indicate $I_C - V_{CE}$ limits of the transistor that must be observed for reliable operation; i.e., the transistor must not be subjected to greater dissipation than the curves indicate.

The data of Figures 5 and 6 is based on $T_{J(pk)} = 150^\circ\text{C}$; T_C is variable depending on conditions. Second breakdown pulse limits are valid for duty cycles to 10% provided $T_{J(pk)} < 150^\circ\text{C}$. $T_{J(pk)}$ may be calculated from the data in Figure 4. At high case temperatures, thermal limitations will reduce the power that can be handled to values less than the limitations imposed by second breakdown.

FIGURE 7 - CAPACITANCE

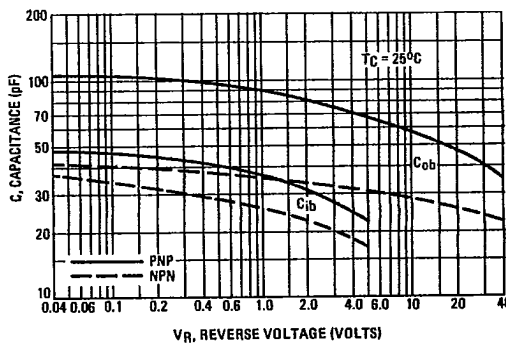

2N6034, 2N6035, 2N6036 PNP
2N6037, 2N6038, 2N6039 NPN

T-33-31

T-33-29

PNP
2N6034, 2N6035, 2N6036

NPN
2N6037, 2N6038, 2N6039

FIGURE 8 - DC CURRENT GAIN

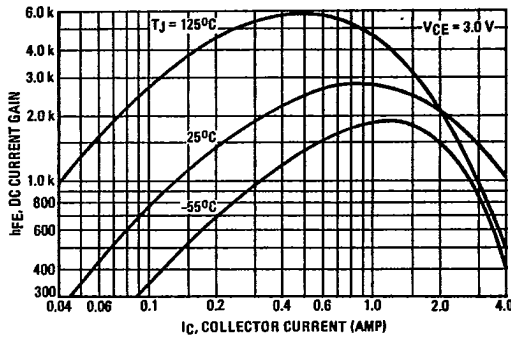
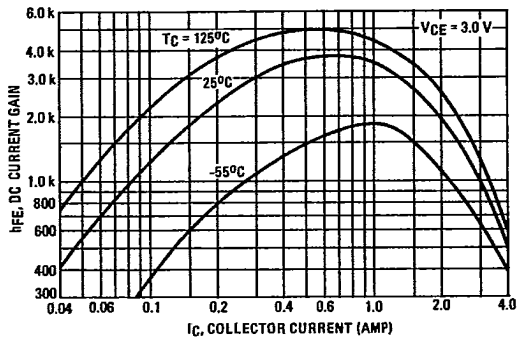

FIGURE 9 - COLLECTOR SATURATION REGION

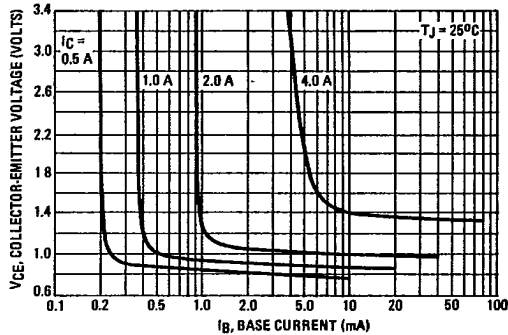
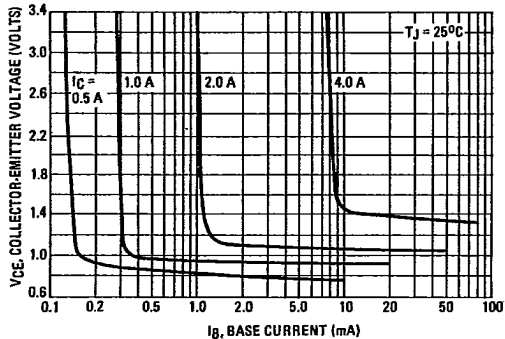

FIGURE 10 - "ON" VOLTAGES

