

The New Switch Disconnecter 194E for «Safe Separation» up to 315 A

Robust, reliable and cost-effective

Robust, reliable and cost-effective. The modular structure, simple handling and high reliability of the new series of load switches predestine them for the popular Modular Control System MCS. Why not make use of the advantages they offer:

- Easy to select the right product
- Simple assembly
- Simple maintenance
- Designed for the world's markets, conform to all standards and suitable for all applications
- Finger-proof switch design (IP20)
- Splash and dust-proof mechanisms and casings (IP65)
- High switching capacity AC-23A
- Simple fitting and removal of accessories
- Functional, pleasing appearance
- Long operational life
- Withstand hard industrial environments
- Modular, durable system subject to ongoing development and innovations



Installation and panel fittings

The new 194E Switch disconnectors can be installed in every cubicle. Shaft extensions enable them to be operated from the front regardless of cubicle depth



Environmentally friendly switches

- No cadmium in the contacts
- Environmentally friendly materials
- Self-extinguishing materials (UL94-V0)
- Switch materials and packing can be recycled.

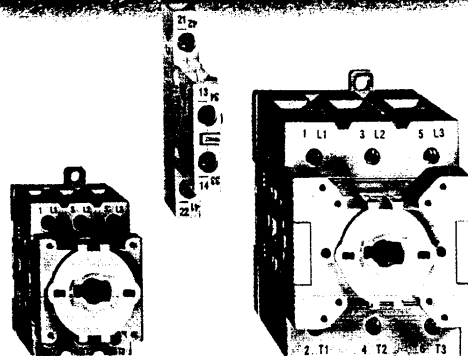

Time-saving terminations

- Large clamping space and cable inlets
- Universal terminal screws for flat and round screwdrivers
- Clear terminal markings

Uniform accessories simplify stocking

- Auxiliary contact blocks fit onto all switch body sizes
- Quickly snapped into place without tools
- Reduced stocks

Safe and reliably in operation

- Large 9 mm contact gap between open contacts
- High fault current withstand ensures minimum probability of welding

The New Switch

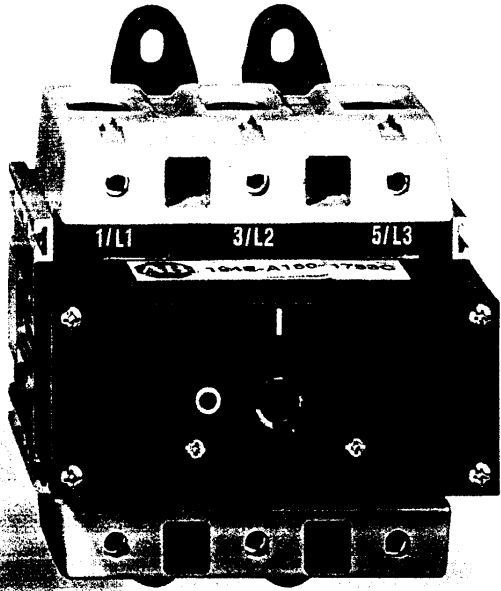

112 mm

125 A

160 A

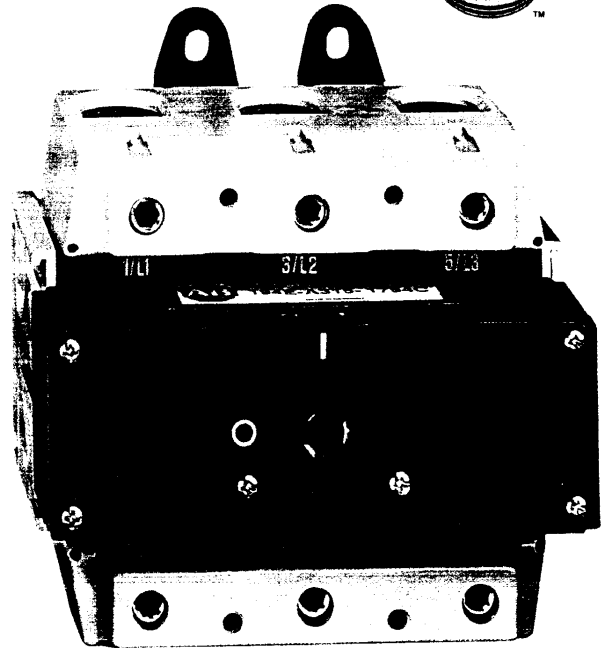

145 mm

250 A

315 A

Switch body for
base mounting



Shaft extensions

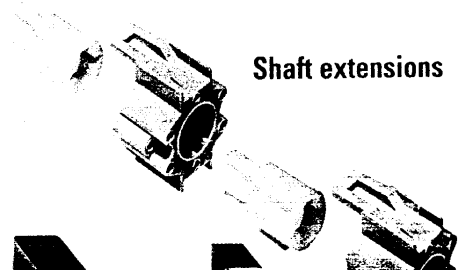

Switch Disconnectors / Bulletin 194E

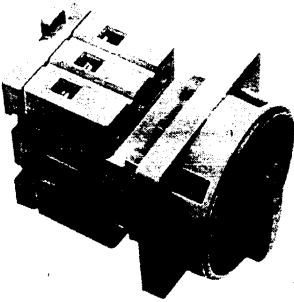

- Rated Current up to 100 A
- Wide Choice of Functions and Switch Positions
- Screw and Central Fixture
- Front or Base Mounting
- Finger-Proof Switch Body (IP20)
- Water Spray and Dust-Proof Actuators (IP65)
- Easily Accessible Terminals
- Clearly Marked Terminals
- Wide Assortment of Accessories

Pages
6... 26

Switch Disconnectors / Bulletin 194E

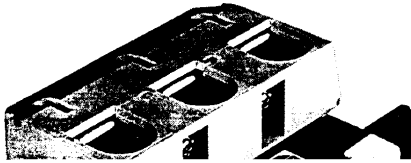

- Rated Current from 125...315 A
- Front or Base Mounting
- Finger-Proof Switch Body (IP20)

Pages
27 ... 40

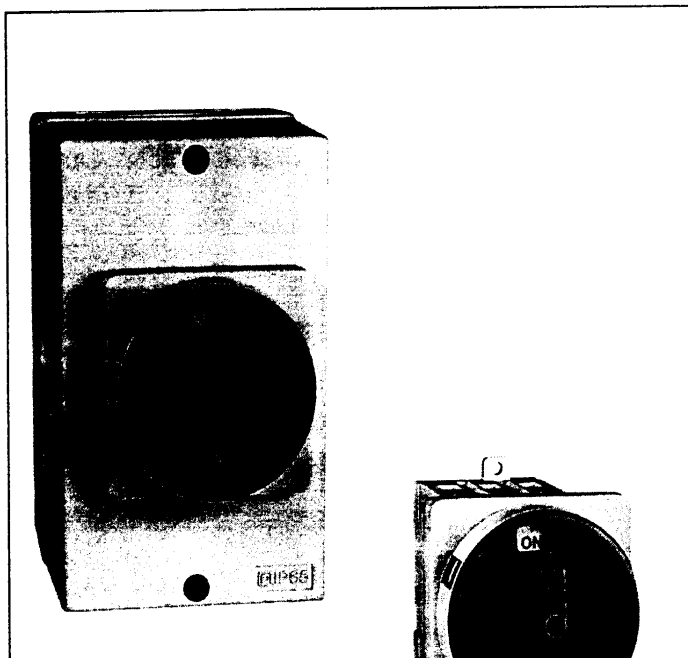



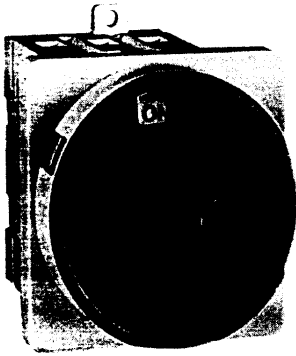

Switch Disconnectors Bulletin 194E

- Rated Current up to 100 A
- Wide Choice of Functions and Switch Positions
- Screw and Central Fixture
- Front or Base Mounting
- Finger-Proof Switch Body (IP20)
- Water Spray and Dust-Proof Actuators (IP65)
- Easily Accessible Terminals
- Clearly Marked Terminals

Load Switches



- 3 and 4 pole versions
- Protection class IP65
- Finger-proof switch IP20
- Switching angle 90°

Mounting type	Switching angle / Circuit diagram	Rated current at AC-21A / 500 V	Rated power at AC-23A / 400 V	With Type N actuator	With Type G actuator	With Type A actuator
		[A]	[kW]	 Cat. No.	 Cat. No.	 Cat. No.
For front installation 		25	11	194E-E25-1753-6N	194E-E25-1753-6G	194E-E25-1753-6A
		32	15	194E-E32-1753-6N	194E-E32-1753-6G	194E-E32-1753-6A
		40	18.5	194E-E40-1753-6N	194E-E40-1753-6G	194E-E40-1753-6A
		63	22	194E-E63-1753-6N	194E-E63-1753-6G	194E-E63-1753-6A
		80	27	194E-E80-1753-6N	194E-E80-1753-6G	194E-E80-1753-6A

Bulletin 194E
Switch Disconnectors
 Complete Switches

Load Switches, Type Q for Installation in Distribution Cubicle

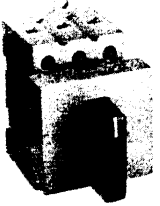

- For distribution panels with standard 45 mm cut-outs
- Uniform overall depth of 60 mm
- Finger-proof switch IP20

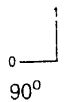
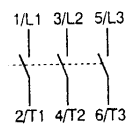
Function Switching angle	Circuit diagram	Rated current at AC-21A / 500 V [A]	Rated power at AC-23A / 400 V [kW]	Cat. No.
For base mounting 		25 32	11 15	194E-A25-1753-Q 194E-A32-1753-Q

Load Switches / EMERGENCY-OFF Switches, Type R for Installation in Distribution Cubicle

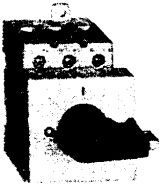

- For distribution panels with standard 45 mm cut-outs
- Uniform overall depth of 60 mm
- Finger-proof switch (IP20)
- Yellow legend plate and red knob
- Provision for locking with 1 padlock

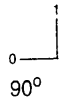
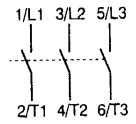
Function Switching angle	Circuit diagram	Rated current at AC-21A / 500 V [A]	Rated power at AC-23A / 400 V [kW]	Cat. No.
For base mounting 		25 32	11 15	194E-A25-1753-R 194E-A32-1753-R

Load Switches in Enclosure



- Yellow legend plate and red knob
- Provision for locking with 3 padlocks
- Switch interlocked when switch is in ON position

Bulletin 194E

Switch Disconnectors

Individual Components: Type Designation

Switch Bodies

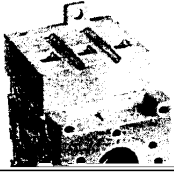

For front installation

Cat. No.

Switch bodies with screw fixture

194E-E

For base mounting

Switch bodies with screw fixture or

194E-A

Actuators for 25...100 A Switches

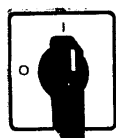

A

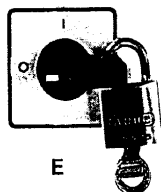

E



G



I



N

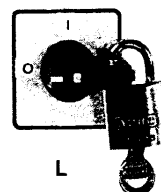

L



S

	Cat. No.	Protection Class IP65
Actuators with screw fixture	194L-HE	
194E-E and 194E-A switches		
Standard version, Type A	for switch	
Black front frame, black knob		
with silver-grey legend plate 48 x 48 mm	25...63 A	4A
with silver-grey legend plate 64 x 64 mm	25...100 A	6A
with silver-grey legend plate 88 x 88 mm	40...100 A	8A
Main switch, Type E		
Black front frame and knob, provision for locking with 1 padlock		
with silver-grey legend plate 48 x 48 mm	25...63 A	4E
with silver-grey legend plate 64 x 64 mm	25...100 A	6E
Main switch, Type G		
Grey legend plate, black knob, provision for locking with 3 padlocks		
Size: 67 x 67 mm	25...100 A	6G ①
Size: 90 x 90 mm	40...100 A	8G ①
EMERGENCY OFF switch, Type I		
Black front frame, red knob		
with yellow legend plate 48 x 48 mm	25...63 A	4I
with yellow legend plate 64 x 64 mm	25...100 A	6I
with yellow legend plate 88 x 88 mm	40...100 A	8I
Main switch / EMERGENCY OFF switch, Type L		
Black front frame, red knob, provision for locking with 1 padlock		
with yellow legend plate 48 x 48 mm	25...63 A	4L
with yellow legend plate 64 x 64 mm	25...100 A	6L
Main switch / EMERGENCY OFF switch, Type N		
Yellow legend plate, red knob, provision for locking with 3 padlocks		
Size: 67 x 67 mm	25...100 A	6N ①
Size: 90 x 90 mm	40...100 A	8N ①
Standard version A with silver-grey label, Type S		
Black front frame, silver-grey legend plate, black knob		
Size: 48 x 62 mm	25...63 A	4S
Size: 64 x 78 mm	25...100 A	6S
Inscription No. (Enter from selection tables on page 12)		xxxz①
Actuators without legend plates		001

① The letter "z" denotes a different inscription for the same circuit (e.g. 175 I for ON/OFF instead of 175 for 0-1). This does not apply to types G and N which have inscriptions for both 0-1 and ON-OFF.

Switch Disconnectors

Individual Components: Product Selection

Switch Body and Actuator Combinations

Switch bodies				For front installation						For base mounting					
Function Switching angle	Circuit diagram	No. of poles	Circuit diagram No.	Cat. No. 194E-E						Cat. No. 194E-A					
				Rated current at						Rated current					
				25-	32-	40-	63-	80-	100-	25-	32-	40-	63-	80-	100-
ON/OFF switches		3	1753	25-	32-	40-	63-	80-	100-	25-	32-	40-	63-	80-	100-
		6	1756	25-	32-	40-	63-	80-	100-	25-	32-	40-	63-	80-	100-
Changeover switches		3	3753	25-	32-	40-	63-	80-	100-	25-	32-	40-	63-	80-	100-

Actuators				For central fixture					
Legend plate with inscription	Legend plate size	No. of leg. plate	Cat. No.	194L-HC					
				Actuator type					
				A-	E-	G-	I-	L-	N-
ON/OFF switches		4 6	175 175	A-	E-	G- ❶	I-	L-	N- ❶
		4 6	175I 175I	A-	E-		I-	L-	
Changeover switches		4 6	375 375	A-	E-		I-	L-	



Actuators				For screw fixture					
Legend plate with inscription	Legend plate size	No. of leg. plate	Cat. No.	194L-HE					
				Actuator type					
				A-	E-	G-	I-	L-	N-
ON/OFF switches		4	175	A-	E-	G- ❶	I-	L-	N- ❶
		6	175	A-	E-	G- ❶	I-	L-	N- ❶
		8	175	A-	E-	G- ❶	I-	L-	N- ❶
Changeover switches		4	175I	A-	E-		I-	L-	
		6	175I	A-	E-		I-	L-	
		8	175I	A-	E-		I-	L-	
Changeover switches		4	375	A-	E-	G-			N-
		6	375	A-	E-				
		8	375	A-	E-				

❶ With both inscriptions 0-1 and ON/OFF



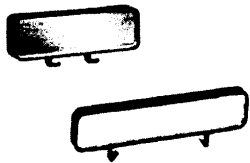
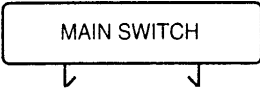
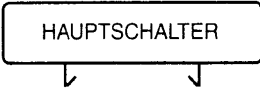
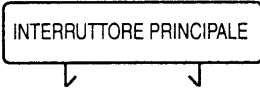
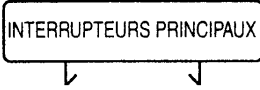
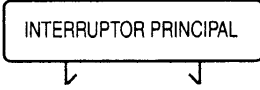
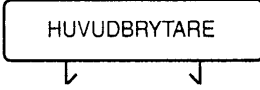
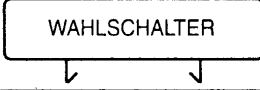
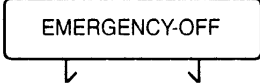

Bulletin 194E
Switch Disconnectors
 Accessories

	Description	for use with	Cat. No.
	Legend plate for actuators, without inscription silver-grey 48 x 48 mm yellow 48 x 48 mm silver-grey 64 x 64 mm yellow 64 x 64 mm	194E	194L-A4-000 194L-I4-000 194L-A6-000 194L-I6-000

Bulletin 194E
Switch Disconnectors
 Accessories

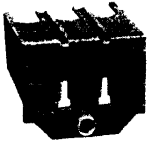
	Description	for use with	Cat. No.
	Lever knob black	Length: 37.5 mm black black	194E 194L-G3154N 194L-G3154R
		Length: 48 mm black red	194E 194L-G3155N 194L-G3155R
	Lever knob with locking device black red	194E	194L-G2864N 194L-G2864R
	Handle knob and shaft for 194E-A		
	Handle knob with door interlock Protection class IP66 Metal shaft	black red / yellow Length 300 mm	194E-A 194R-HS4 194R-HS4E 194E-G-3675
	Additional name plate with and without inscription For actuators size: 48 x 48 mm, 64 x 64 mm and 67 x 67 mm	Size: 48 x 15 mm	194E-E/A 194L-G3667
	88 x 88 mm, 90 x 90 mm, 130 x 130 mm and 135 x 135 mm	Size: 88 x 18 mm	194L-G3515
	MAIN SWITCH	Size: 48 x 15 mm Size: 88 x 18 mm	194E-E/A 194L-G3667A 194L-G3515A 194L-G3667B 194L-G3515B 194L-G3667C 194L-G3515C 194L-G3667D 194L-G3515D 194L-G3667E 194L-G3515E 194L-G3667F 194L-G3515F 194L-G3667G 194L-G3515G 194L-G3667H 194L-G3515H
	HAUPTSCHALTER	Size: 48 x 15 mm Size: 88 x 18 mm	
	INTERRUTTORE PRINCIPALE	Size: 48 x 15 mm Size: 88 x 18 mm	
	INTERRUPTEURS PRINCIPAUX	Size: 48 x 15 mm Size: 88 x 18 mm	
	INTERRUPTOR PRINCIPAL	Size: 48 x 15 mm Size: 88 x 18 mm	
	HUVUDBRYTARE	Size: 48 x 15 mm Size: 88 x 18 mm	
	WAHLSCHALTER	Size: 48 x 15 mm Size: 88 x 18 mm	
	EMERGENCY-OFF	Size: 48 x 15 mm Size: 88 x 18 mm	

Bulletin 194E
Switch Disconnectors
 Accessories

	Description	for use with	Cat. No.
	Terminal covers 1 pole	194E-25/32 194E-40/63 194E-80/100	194E-25-C1 194E-40-C1 194E-80-C1
	Terminal covers 3 poles	194E-25/32 194E-40/63 194E-80/100	194E-25-C3 194E-40-C3 194E-80-C3
	Terminal covers 4 poles	194E-25/32 194E-40/63 194E-80/100	194E-25-C4 194E-40-C4 194E-80-C4
	Installation tool (Actuators 194L-HC) for tightening the central fixture nut	194E	800E-AW2
	Thermo-plastic enclosures Size 95 x 150 x 86 mm, Protection Class IP65, for use with 194L-A / LA 212/16/20/25 with max. 2 switch banks and 194E-25/32 with max. 4 poles Enclosure	194E	ABS Noryl 194L-G3572 194L-G3576
	Size 125 x 180 x 105 mm, Protection Class IP65, for use with 194E-40/63 with 3-4 poles and 194E-25/32 with 6 poles Enclosure	194E-A	ABS Noryl 194E-G3663 194E-G3664
	Size 175 x 230 x 120 mm, Protection Class IP65, for use with 194E-80/100 with 3-4 poles and 194E-40/63 with 6 poles Enclosure	194E-A	ABS Noryl 194E-G3665 194E-G3666
	Additional ground and neutral terminals for thermo-plastic enclosures for enclosure type 194L-G3572 and 194L-G3576	194E-A	194E-G3653
	for enclosure type 194E-G3663, 194E-G3664, 194E-G3665 and 194E-G3666		194E-G3673

Bulletin 194E
Switch Disconnectors
Accessories

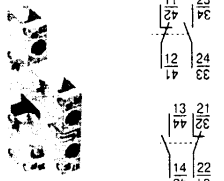
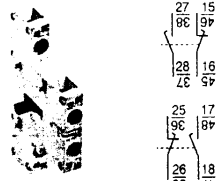
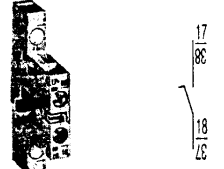
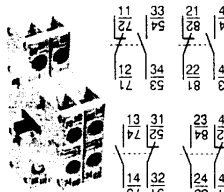
	Description	for use with	Cat. No.
	<p>Auxiliary switch blocks with 1 N/C and 1 N/O contact, for fitting to the left or right side</p>	<p>194E-E25...100 194E-A25...100</p>	<p>194E-E-P11 194E-A-P11</p>
	<p>Auxiliary switch blocks with 1 early closer and 1 N/O make-before-break, for fitting to the left or right side</p>	<p>194E-E25...100 194E-A25...100</p>	<p>194E-E-PL11 194E-A-PL11</p>
	<p>Auxiliary switch blocks with 1 N/O early break, for fitting to the left or right side</p>	<p>194E-E25...100 194E-A25...100</p>	<p>194E-E-PD10 194E-A-PD10</p>
	<p>Auxiliary switch blocks with 2 N/C and 2 N/O contacts, for fitting to the left or right side</p>	<p>194E-E25...100 194E-A25...100</p>	<p>194E-E-P22 194E-A-P22</p>
	<p>Neutral terminal</p>	<p>194E-E25/32</p>	<p>194E-E32-TN</p>

The plug-on accessories can be fitted to the 194E without difficulty on site:

- Auxiliary switch blocks
- Neutral terminal
- Ground terminal
- Terminal cover

For base mounting

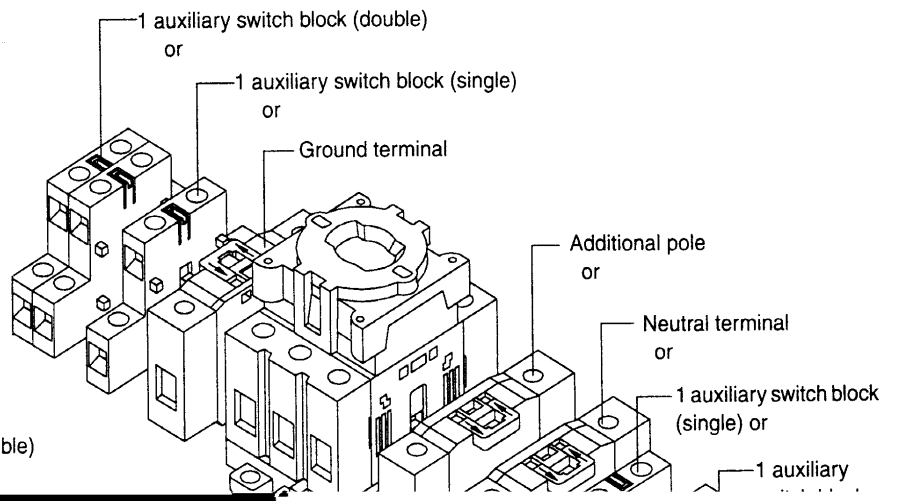

For front installation

1 auxiliary switch block (double)
or

Bulletin 194E
Switch Disconnectors
Accessories

Shaft for Enclosures

Enclosure type	Suitable for:			
	194E-B	No. of poles	Shaft	Ground terminal / Neutral terminal
194L-G3572 194L-G3576 (95 x 150 x 86 mm)	194E-A25 (32)	3 / 4	194L-G3194	194E-G3673
194E-G3663 194E-G3664 (125 x 180 x 105 mm)	194E-A40 (63) 194E-A25 (32)	3 / 4 6	194L-G3194 Standard	194E-G3673
194E-G3665 194E-G3666 (175 x 230 x 120 mm)	194E-A80 (100) 194E-A40 (63) 194E-A25 (32)	3 / 4 6 6	194E-G3707 Standard 194E-G3194	194E-G3673

Maximum Accessories in Enclosures

Enclosure type	Switch	No. of poles	Shaft	Auxiliary switch block (single or double)	Fourth pole	Neutral terminal	Ground terminal	Neutral terminal	Ground terminal	
					on switch			on enclosure		
194L-G3572 194L-G3576 (95 x 150 x 86 mm)	194E-A25 (32)	3P	194L-G3194		•	•				
					•					
					•		•			
					•	•	•			
194E-G3663 194E-G3664 (125 x 180 x 105 mm)	194E-A40 (63)	3P	194L-G3194		•	•		•	•	
					•		•	•	•	
					•	•	•	•	•	
	194E-A25 (32)	6P	Standard			•			•	•
						•			•	•
						•	•	•	•	•
194E-G3665 194E-G3666 (175 x 230 x 120 mm)	194E-A80 (100)	3P	194E-G3707		•		•	•	•	
					•	•	•	•	•	
	194E-A40 (63)	6P	Standard	1L + 1R		•		•	•	
						•	•	•	•	

IEC Performance Data for 194E

	194E-25	194E-32	194E-40	194E-63	194E-80	194E-100	Aux. switches	
Rated voltage U_e : IEC [V]	690	690	690	690	690	690	690	
Rated voltage U_e : UL-CSA [V]	600	600	600	600	600	600	600	
Rated isolation voltage U_i : IEC / UL-CSA [V]	690/600	690/600	690/600	690/600	690/600	690/600	690/600	
Rated impulse voltage U_{imp} : IEC [kV]	8	8	8	8	8	8	6	
Test voltage U_i , 1 min. [kV]	2.5	2.5	2.5	2.5	2.5	2.5	2.5	
Rated frequency [Hz]	50/60	50/60	50/60	50/60	50/60	50/60	50/60	
Thermal rated current I_{th} , open [A]	40	50	63	75	100	120	12	
Thermal rated current I_{the} , enclosed [A]	32	40	50	63	80	100	10	
Rated current I_e 690 V								
AC-1/ Non-inductive or slightly induc. loads								
AC-21A Switching of resistive loads with slight overload [A]	25	32	40	63	80	100	10	
Rated power P_e								
AC-23A Occasional switching of motors and other highly inductive loads (criterion for selecting main switches)	230 V [kW]	7.5	7.5	15	18.5	22	30	-
	400 V [kW]	11	15	18.5	22	37	45	-
	690 V [kW]	11	15	18.5	22	37	45	-
AC-3 Squirrel-cage motors: starting and stopping of running motors	230 V [kW]	5.5	7.5	11	15	18.5	22	-
	400 V [kW]	7.5	11	15	18.5	30	37	-
	690 V [kW]	7.5	11	15	18.5	30	37	-
Short-circuit current								
Conditional rated short-circuit current 400/415 V [kA]	15	15	20	15	30	25	-	
Max. fuse rating of circuit (Type gG) [A]	35	35	50	63	80	100	-	
Rated short-time current I_{cw} , 1s [A]	850	850	1300	1300	2500	2500	-	
Rated breaking capacity								
AC-23A ($\cos \varphi$ 0.45)	230 V [A]	204	204	484	484	780	780	-
	400 V [A]	232	232	336	336	680	680	-
	690 V [A]	136	136	196	196	376	376	-
Control of electromechanical loads								
AC-15	-	-	-	-	-	-	A600	
DC-13	-	-	-	-	-	-	Q600	

Max. temperature for changeover switches 40°C

Bulletin 194E
Switch Disconnectors
 Technical Information

IEC Performance Data for 194E

			194E-25	194E-32	194E-40	194E-63	194E-80	194E-100
			[A]	[A]	[A]	[A]	[A]	[A]
DC switching capacity								
Rated current I_e								
Rated voltage [V]	Poles in series							
DC-21 A	48	1	25	32	40	63	80	100
For resistive loads $T \leq 1$ ms	110	1	5	6	8	10	16	20
$U_e \text{ max} = 600\text{V}$	220	1	1	1	1.5	1.5	3	3
	440	1	0.5	0.5	0.6	0.6	0.7	0.7
Rated voltage [V]	Poles in series							
	96	2	25	32	40	63	80	100
	110	2	23	25	32	50	70	80
	220	2	5	6	8	10	16	20
	440	2	1	1	1.5	1.5	3	3
	600	2	0.6	0.6	0.8	0.8	1	1
Rated voltage [V]	Poles in series							
	110	3	25	32	40	63	80	100
	220	3	13	15	20	28	50	63
	440	3	2.2	2.2	3.6	3.6	6.5	6.5
	600	3	1.5	1.5	2	2	3	3

DC-23A, DC-3, DC-5 for inductive loads $T \leq 7.5$ ms, $U_e \text{ max} = 600$ V

			194E-25	194E-32	194E-40	194E-63	194E-80	194E-100
			[A]	[A]	[A]	[A]	[A]	[A]
DC switching capacity								
Rated current I_e								
Rated voltage [V]	Poles in series							
	90	3	25	32	40	50	63	80
	110	3	16	25	32	40	50	63
	220	3	4	5	7.5	9	16	20
	440	3	1.2	1.2	2	2	2.5	2.5
	600	3	0.6	0.6	0.75	0.75	1.5	1.5
			194E-25	194E-32	194E-40	194E-63	194E-80	194E-100
			[kW]	[kW]	[kW]	[kW]	[kW]	[kW]
DC switching capacity								
Rated power P_e								
Rated voltage [V]	Poles in series							
	90	3	2.3	2.9	3.6	4.5	5.7	7.2
	110	3	1.8	2.8	3.5	4.4	5.5	7.0
	220	3	0.9	1.1	1.7	2.0	3.52	4.4
	440	3	0.6	0.6	0.9	0.9	1.1	1.1
	600	3	0.4	0.4	0.5	0.5	0.9	0.9

Power losses per pole	194E-25/32	194E-40/63	194E-80/100
at rated current	≤ 0.85 m Ω	≤ 0.75 m Ω	≤ 0.60 m Ω

Bulletin 194E
Switch Disconnectors
Dimensions

Front Installation 194E-E

Dimensions [mm]

3 poles

Actuators

Type	P	Q
194L-HE4A	28	48 x 48
194L-HE4I	28	48 x 48
194L-HE4S	28	48 x 62
194L-HE6A	28	64 x 64
194L-HE6I	28	64 x 64
194L-HE6S	28	64 x 78
194L-HE6N	34	67 x 67
194L-HE6G	34	67 x 67
194L-HE8A	45	88 x 88
194L-HE8I	45	88 x 88
194L-HE8G	49	92 x 92
194L-HE8N	49	92 x 92

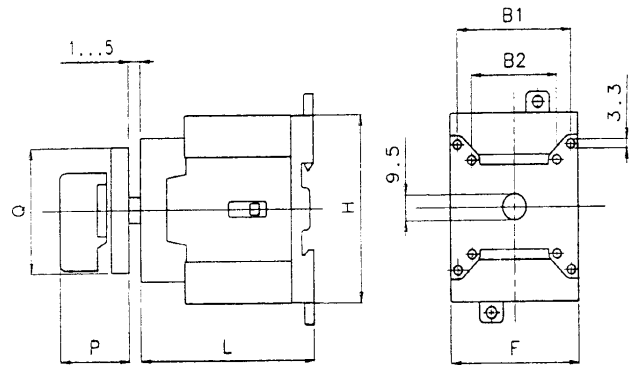

Type	B1	B2	F	H	L
194E-E25/32	-	36	45	64	60
194E-E40/63	48	36	54	72	74
194E-E80/100	48	36	72	90	90

194E-E switch body with 194L-HCA actuators for central fixture

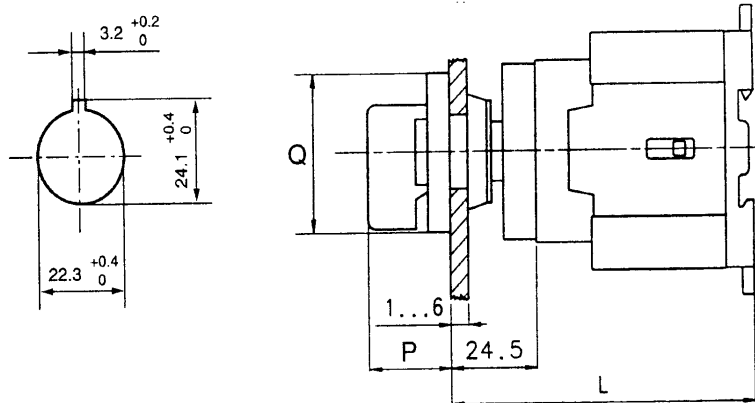

Type	L
194E-E25/32	84.5
194E-E40/63	98.5
194E-E80/100	114.5

Front Installation 194E-E

6 poles

Actuators

Type	P	Q
194L-HE4A	28	48 x 48
194L-HE4I	28	48 x 48
194L-HE4S	28	48 x 62
194L-HE6A	28	64 x 64
194L-HE6I	28	64 x 64
194L-HE6S	28	64 x 78
194L-HE6N	34	67 x 67
194L-HE6G	34	67 x 67
194L-HE8A	28	48 x 48
194L-HE8I	28	48 x 48
194L-HE8G	28	48 x 62
194L-HE8N	28	64 x 64

Type	B1	B2	F	H	L	G
194E-E25/32	-	36	90	64	85	90
194E-E40/63	-	36	108	72	99	108
194E-E80/100	48	36	144	90	115	144

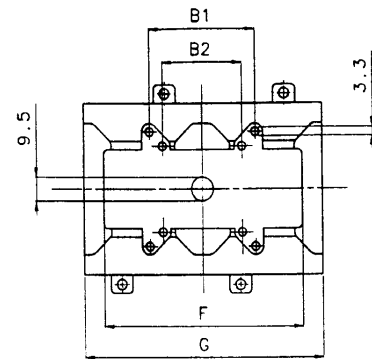
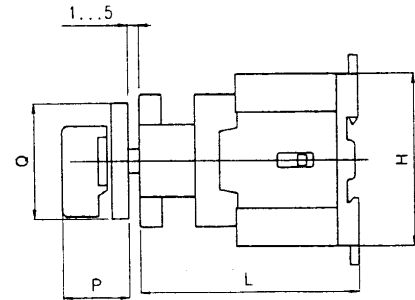

Base Mounting 194E-A

Dimensions [mm]

3 poles

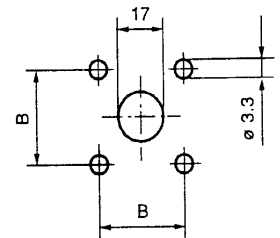
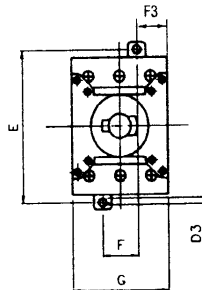
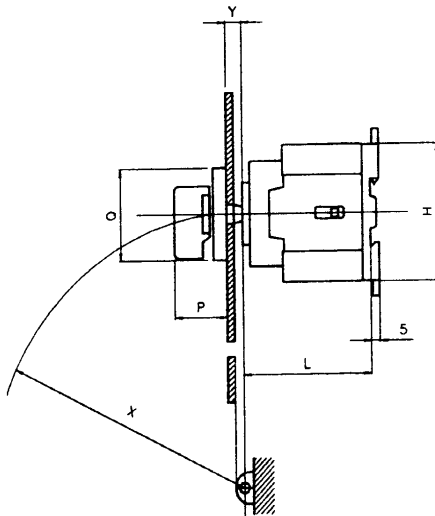

Type	Y min.	X ≤	Y max.	X ≤
194E-A25/32	5	142	9.5	90
194E-A40/63	2.5	150	9.5	90
194E-A80/100	2.5	150	9.5	90

Type	D3	E	F	F3	G	H	L
194E-A25/32	4.5	70	15	15	45	64	59
194E-A40/63	4.5	80	20	17	54	72	73
194E-A80/100	5.6	95	25	25.5	72	90	89

Actuators

Type	P	B	Q
194L-HE4A	28	36	48 x 48
194L-HE4I	28	36	48 x 48
194L-HE4S	28	36	48 x 62
194L-HE6A	28	48	64 x 64
194L-HE6I	28	48	64 x 64
194L-HE6S	28	48	64 x 78
194L-HE6N	34	48	67 x 67
194L-HE6G	34	48	67 x 67
194L-HE8A	45	48	88 x 88
194L-HE8I	45	48	88 x 88
194L-HE8G	49	48	92 x 92
194L-HE8N	49	48	92 x 92

Bulletin 194E
Switch Disconnectors
 Dimensions

Base Mounting 194E-A

Dimensions [mm]

6 poles

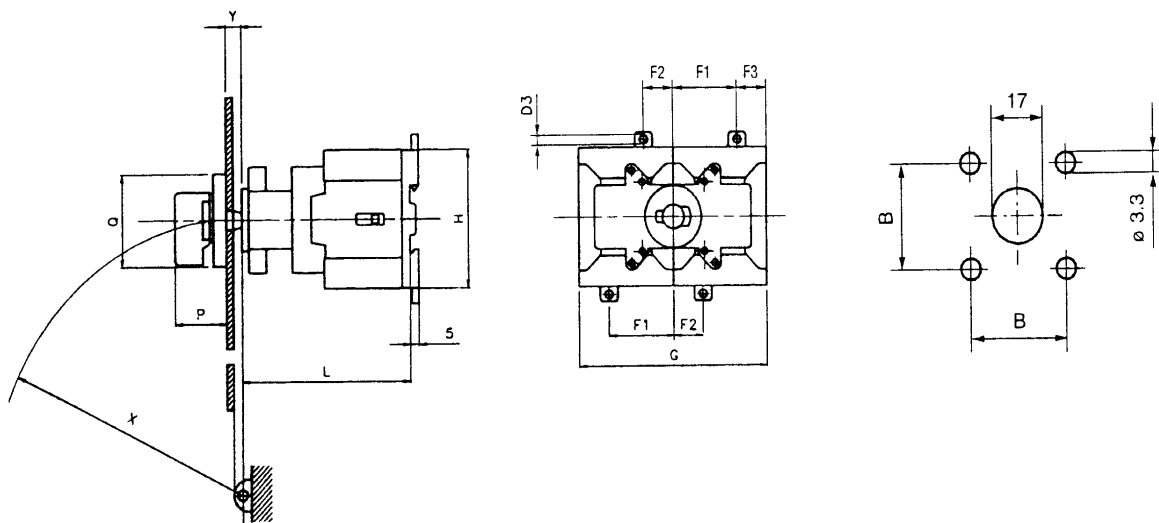

Type	Y min.	X ≤	Y max.	X ≤
194E-A25/32	5	142	9.5	90
194E-A40/63	2.5	150	9.5	90
194E-A80/100	2.5	150	9.5	90

Type	D3	E	F1	F2	F3	G	H	L
194E-A25/32	4.5	70	30	15	15	90	64	84
194E-A40/63	4.5	80	37	17	17	108	72	98
194E-A80/100	5.6	95	48.5	23.5	25.5	144	90	114

Actuators

Type	P	B	Q
194L-HE4A	28	36	48 x 48
194L-HE4I	28	36	48 x 48
194L-HE4S	28	36	48 x 62
194L-HE6A	28	48	64 x 64
194L-HE6I	28	48	64 x 64
194L-HE6S	28	48	64 x 78
194L-HE6N	34	48	67 x 67
194L-HE6G	34	48	67 x 67
194L-HE8A	45	48	88 x 88
194L-HE8I	45	48	88 x 88
194L-HE8G	49	48	92 x 92
194L-HE8N	49	48	92 x 92

194E-A Type Q load switch and main switch / EMERGENCY OFF switch,
 Type R load switch for installation in distribution cubicle

3 poles

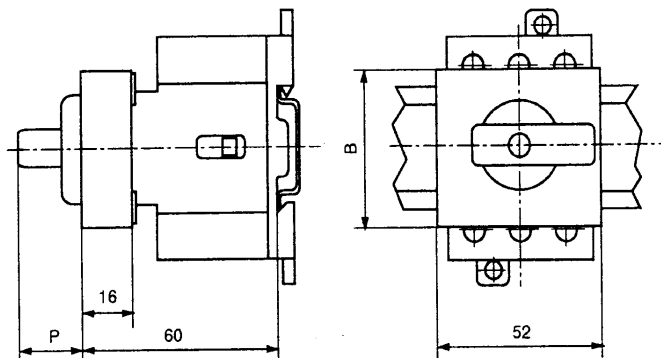

Type	P	B
194E-AQ	20	45
194E-AR	23	45

Base Mounting 194E-A

Dimensions [mm]

194E-A switch body with 194L-G2853 shaft (Thermo-plastic)

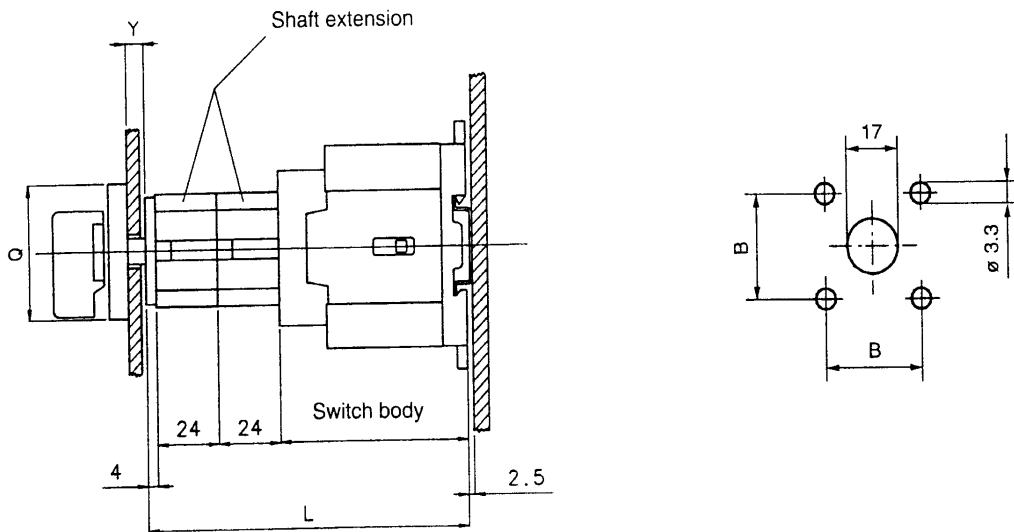

Switch bodies

No. of switch banks	194E-A25/32	194E-A40/63	194E-A80/100
L with 1 shaft extension	88	102	118
L with 2 shaft extensions	112	126	142
L with 3 shaft extensions	136	150	166
L with 4 shaft extensions	160	174	190
L with 5 shaft extensions	184	198	214
L with 6 shaft extensions	208	222	238

Actuators

Type	Y	Type	B	Q
194L-G2830	2.5...9.5	194L-HE4A	36	48 x 48
194L-G3194	9...18	194L-HE4I	36	48 x 48
194L-G3195	14...23	194L-HE6A	48	64 x 64
		194L-HE6I	48	64 x 64
		194L-HE6N	48	67 x 67
		194L-HE6G	48	67 x 67

Base Mounting 194E-A

194E-A switch body with metal shaft extension

Type	A
194L-G3393	110...235
194L-G3394	230...350

Type	L [⊕]
194E-A25/32	60
194E-A40/63	74
194E-A80/100	90

⊕ + 2.5 mm DIN 46 277 (35 mm) rails

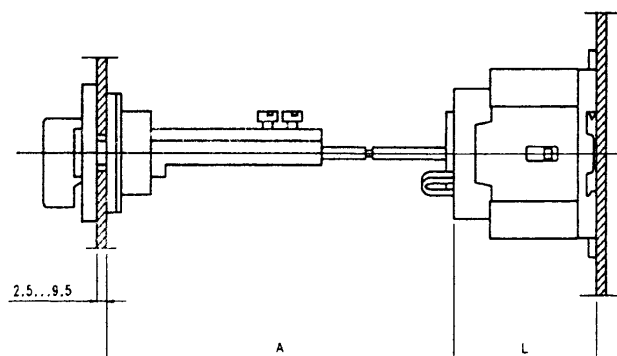

Additional Name Plates

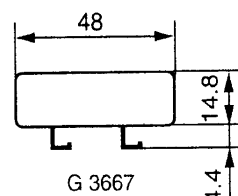
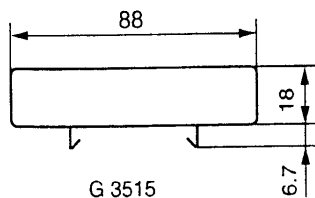

Bulletin 194E
Switch Disconnectors
 Dimensions

Base Mounting and Front Installation

Dimensions [mm]

194E with auxiliary switch block fitted

Contacts	M
1 N/O + 1 N/C	9
2 N/O + 2 N/C	18

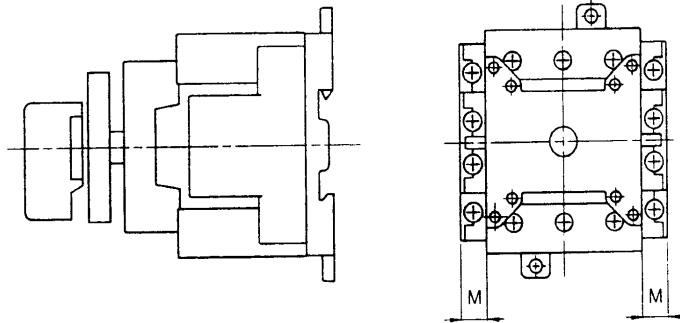

194E with 4th pole, ground and neutral terminals

Type	M
194E-20/32	14
194E-40/63	17.5
194E-80/100	22

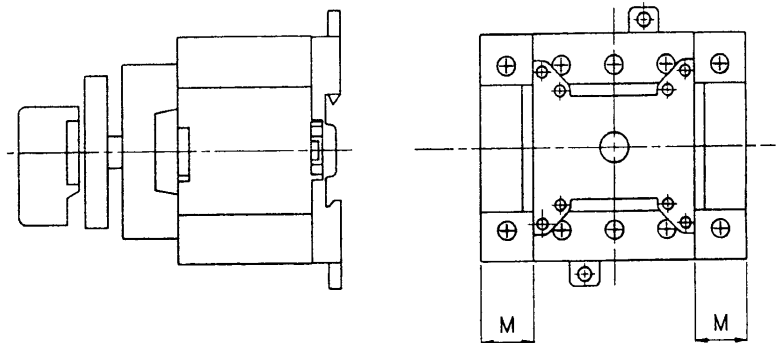

Front Installation 194E-E

194E load switch in enclosure

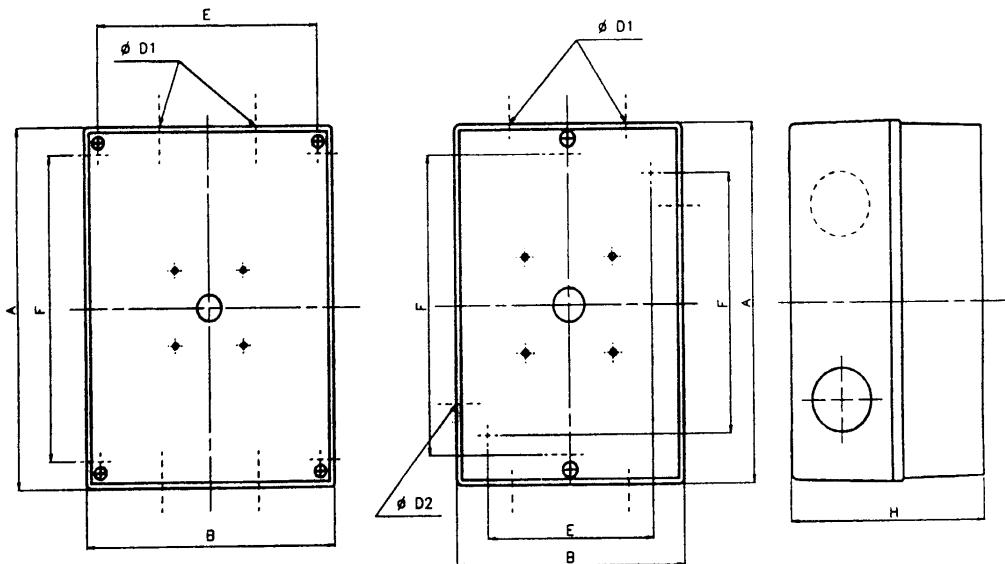

Complete switches		Enclosure		A	B	øD1	øD2	E	F	H
Type	Poles	ABS	Noryl							
194E-Y 3-32	3 e 4	194L-G3572	194L-G3576	150	95	22.5	22.5	60	115	86
	6	194E-G3663	194E-G3664	180	125	37.5	-	-	145	105
194E-Y 3-40/63	3 e 4	194E-G3663	194E-G3664	180	125	37.5	-	-	145	105
	6	194E-G3665	194E-G3666	230	175	47.5	-	155	195	120
194E-Y 3-80/100	3 e 4	194E-G3665	194E-G3666	230	175	47.5	-	155	195	120

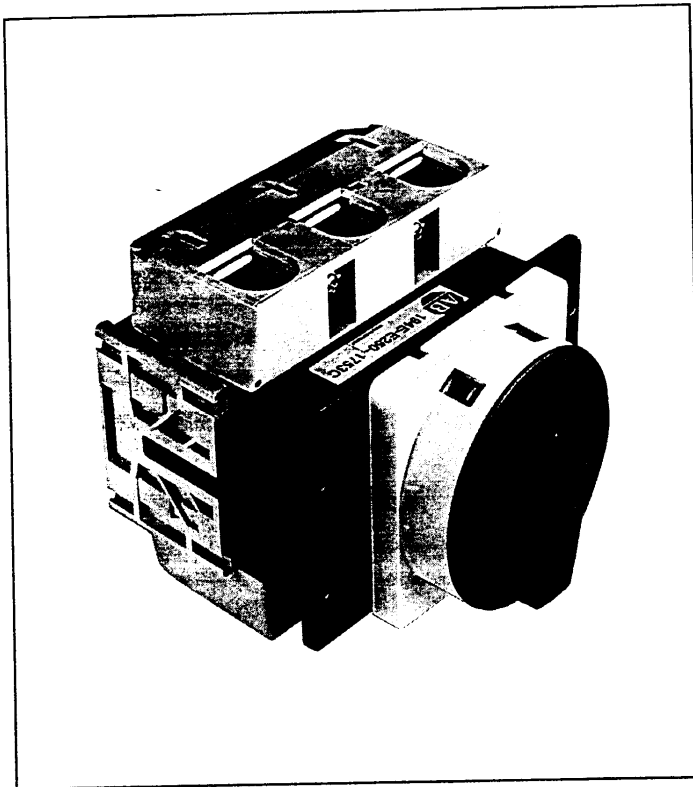

Switch disconnectors Bulletin 194E

- Rated Current from 125 ... 315 A
- Front or Base Mounting
- Finger-Proof Switch Body (IP20)
- Water Spray and Dust-Proof Actuators (IP65)
- Easily Accessible Terminals
- Clearly Marked Terminals
- Wide Assortment of Accessories

Contents

Description	Pages	Description	Pages
Type Designation	28	Technical Information	33
Product Selection	30	Standards and Approvals	35
Accessories	31	Dimensions	36

Bulletin 194E
Switch Disconnectors
Type Designation

Switch bodies 125...315 A

No. di
Cat.

For front installation
Switch body with screw fixture, box terminals

194E-E - - -

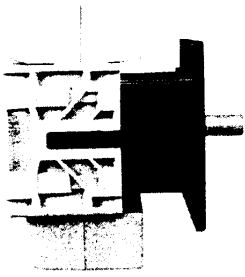

For base mounting
Switch body with screw fixture, box terminals
(includes door coupling pieces and door interlock)

194E-A - - -

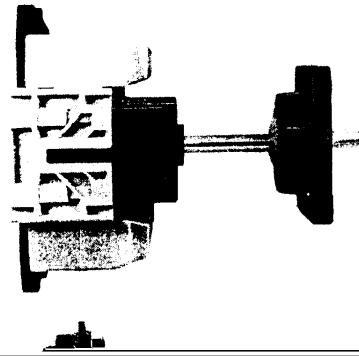

For front installation
Switch body with screw fixture, bolt terminals

194E-F - - -

For base mounting

194E-G - - -

Actuators for 125...315 A Switches

Protection Class IP65

Cat. No.

194E-HE -

Actuators with screw fixture

194E-E and 194E-A switches

Standard version, Type A

Black front frame, black knob
 with silver-grey legend plate 88 x 88 mm
 with silver-grey legend plate 130 x 130 mm

for switch

125...315 A **8A**
 125...315 A **13A**



A

Standard version, Type G

Black front frame and knob,
 provision for locking with 3 padlocks, size 90 x 90 mm
 provision for locking with 3 padlocks, size 135 x 135 mm

125...315 A **8G**
 125...315 A **13G**

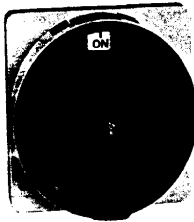

G

EMERGENCY OFF switch, Type I

Black front frame, red knob
 with yellow legend plate 88 x 88 mm
 with yellow legend plate 130 x 130 mm

125...315 A **8I**
 125...315 A **13I**

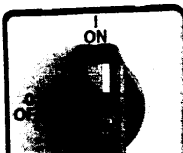





Bulletin 194E
Switch Disconnectors
 Product Selection

Switch Body and Actuator Combinations

Switch bodies				For front installation				For base mounting			
				Cat. No.		194E-E/F		Cat. No.		194E-A/B	
Function Switching angle	Circuit diagram	Poles	Circuit diagram No.	Rated current				Rated current			
				125-	160-	250-	315-	125-	160-	250-	315-
ON/OFF switches		3	1753	125-	160-	250-	315-	125-	160-	250-	315-
		4	1754	125-	160-	250-	315-	125-	160-	250-	315-

Actuators				For central fixture			
				Cat. No.		194E-HE	
Legend plate with inscription	Legend plate size	No. of leg. plate	Actuator type				
			A-	G-	I-	N-	
ON/OFF switches		8	A- ❶	G- ❶	I- ❶	N- ❶	
		13	A- ❶	G- ❶	I- ❶	N- ❶	



❶ With both inscriptions 0-1 and ON/OFF

	Description	For type	Cat. No.
	Auxiliary switch blocks with 1 N/C and 2 N/O contacts, for fitting to the left or right side	For base mounting 194E-125...315	194E-AB-P21-160 194E-AB-P21-315
		For front installation 194E-125...315	194E-EF-P21-160 194E-EF-P21-315
 N N	Neutral terminal for fitting to the right side	For base mounting and front installation	with box terminals 194E-125...160 194E-250...315 194E-AE160-TN 194E-AE315-TN
 N N	Ground terminal for fitting to the right side	For base mounting and front installation	with bolt terminals 194E-125...160 194E-250 194E-315 194E-BF160-TN 194E-BF250-TN 194E-BF315-TN
 PE PE	Ground terminal for fitting to the left side	For base mounting and front installation	with box terminals 194E-125...160 194E-250...315 194E-AE160-PE 194E-AE315-PE
 PE PE	Ground terminal for fitting to the left side	For base mounting and front installation	with bolt terminals 194E-125...160 194E-250 194E-315 194E-BF160-PE 194E-BF250-PE 194E-BF315-PE

Bulletin 194E

Switch Disconnectors

Accessories

	Description	For type	Cat. No.
	Terminal covers, 1 pole Box terminal	194E-125...160 194E-250...315	194E-AE125-C1 194E-AE250-C1
	Terminal covers, 1 pole Bolt terminal	194E-125...160	194E-BF125-C1

IEC Performance Data for 194E

				194E-125	194E-160	194E-250	194E-315	Aux. switches	
Rated isolation voltage U_i ①				[V]	1000	1000	1000	1000	690
Rated impulse voltage U_{imp}				[kV]	8	8	8	8	
Test voltage U_i , 1 min.				[kV]	3.5	3.5	3.5	3.5	
Rated voltage U_e ① ②				[V]	1000	1000	1000	1000	690
Rated frequency				[Hz]	50/60	50/60	50/60	50/60	50/60
Thermal rated current I_{th} , open				[A]	125	160	250	315	
Thermal rated current I_{the} , enclosed				[A]	125	160	250	315	
Rated current I_e									
AC-1 / Non-inductive or slightly induct. loads									
AC-21A	Switching of resistive loads with slight overload			[A]	125	160	250	315	16
Rated power P_e									
AC-23A	Occasional switching of motors and other highly inductive loads	230 V	[kW]	30	30	37	55		
		400 V	[kW]	45	55	90	110		
		690 V	[kW]	37	37	45	45		
AC-3	Squirrel-cage motors: starting and stopping of running motors	230 V	[kW]	22	30	37	45		
		400 V	[kW]	37	45	55	75		
		690 V	[kW]	30	37	45	45		
Short-circuit current									
Conditional rated short-circuit current		400/415 V	[kA]	30	30	30	30		
Max. fuse rating of circuit (Type gG)				[A]	125	160	250	315	
Rated short-time current I_{cw} , 1s				[A]	2500	3000	4600	5800	
Rated breaking capacity									
AC-23A (cos φ 0.45)									
	230 V	[A]		800	900	1600	1800		
	400 V	[A]		750	850	1380	1650		
	690 V	[A]		340	340	400	400		
DC switching capacity									
Rated current I_e									
		Rated voltage [V]	Poles						
DC-21 A	For resistive loads $T \leq 1$ ms	60	3	[A]	125	160	250	315	
		110	3	[A]	110	140	220	280	
		220	3	[A]	45	55	85	110	
		Rated voltage [V]	Poles in series						
	110	4	[A]	125	160	250	315		
	220	4	[A]	80	100	150	200		
	440	4	[A]	16	20	32	40		
Rated power P_e									
		Rated voltage [V]	Poles in series						
DC-22A, DC-3	For resistive loads $t \leq 2.5$ ms	24	4	[kW]	3	3.8	6	7.5	
		48	4	[kW]	6	7.5	12	15	
		60	4	[kW]	7.5	9.5	15	19	
		110	4	[kW]	10	12.5	20	25	
		220	4	[kW]	4.5	5.5	8	10	
Rated voltage [V]									
			Poles in series						
DC-23A, DC-5	For resistive loads $T \leq 15$ ms	24	4	[kW]	3	3.8	6	7.5	
		48	4	[kW]	6	7.5	12	15	
		60	4	[kW]	7.5	9.5	15	19	
		110	4	[kW]	8.8	11	17.5	22	
		220	4	[kW]	2.5	3.5	5.5	7	

① Valid for line with grounded common neutral termination, overvoltage category III, pollution degree 3.
 ② Suitable for no load switching application (AC-20 A) above 690 V.

Bulletin 194E
Switch Disconnectors
Technical Information

UL/CSA Performance Data for 194E

			194E-125	194E-160	194E-250	194E-315	Aux. switches	
Rated isolation voltage U_i	[V]		600	600	600	600		
Rated voltage U_e	[V]		600	600	600	600		
Rated current	[A]		150	200	250	300	10	
Heavy Pilot Duty	[AC]						A600	
Standard Duty	[DC]						-	
Rated power 60 Hz 1-phase (2 poles)	120 V, 1 P	[FLA]	80	100	135	180		
		[HP]	7.5	10	15	20		
	240 V, 1 P	[FLA]	88	110	136	155		
		[HP]	20	25	30	35		
	480 V, 1 P	[FLA]	78	88	99	108		
		[HP]	35	40	45	50		
	600 V, 1 P	[FLA]	62	70	86	104		
		[HP]	35	40	50	60		
	3-phases	120 V, 3 P	[FLA]	84	108	160	208	
			[HP]	15	20	30	40	
		240 V, 3 P	[FLA]	80	104	154	192	
			[HP]	30	40	60	75	
480 V, 3 P		[FLA]	77	77	96	124		
		[HP]	60	60	75	100		
600 V, 3 P		[FLA]	62	62	77	99		
		[HP]	60	60	75	100		

Mechanical Data

Actuators			IP65	IP65	IP65	IP65	
Protection class acc. to IEC 529							
Front side			IP65	IP65	IP65	IP65	
Box terminals ①			IP20	IP20	IP20	IP20	
Bolt terminals		125...250 A 315A	IP20	IP20	IP20	IP00	
Mechanical life	[Million operations]		0.1	0.1	0.075	0.075	
Max. wire gauges - box terminals							
Terminal sizes according to IEC 947-1	Wire gauges	No.	B11	B11	B14	B14	
Fine strands	1 conductor	Max	70	70	150	150	
		Min.	16	16	25	25	
Rigid wire	1 conductor	Max	95	95	185	185	
		Min.	10	10	16	16	
Max. wire gauges acc. to UL / CSA	Max	[AWG]	3/0	3/0	350	350	
		MCM			4	4	
	Min.	[AWG]	8	8	4	4	

① With terminal cover

Bulletin 194E
Switch Disconnectors
 Norme e omologazioni

Approvals

		UL Listed	Recognized by UL	cUL Listed	cUR Recognized	CE
194E-A125	194E-E125	A		A		A
194E-A160	194E-E160	A		A		A
194E-A250	194E-E250	A		A		A
194E-A315	194E-E315	A		A		A
194E-B125	194E-F125		A		A	A
194E-B160	194E-F160		A		A	A
194E-B250	194E-F250		A		A	A
194E-B315	194E-F315		A		A	A
Auxiliary switch block		Z	Z	Z	Z	Z
Ground terminal		Z	Z	Z	Z	Z
Neutral terminal		Z	Z	Z	Z	Z

A = Approved or test passed
 Z = Accessories are covered by the approval for the switch

Bulletin 194E
Switch Disconnectors
Dimensions

Front Installation, Box Terminals 3-, 4 poles

Dimensions [mm]

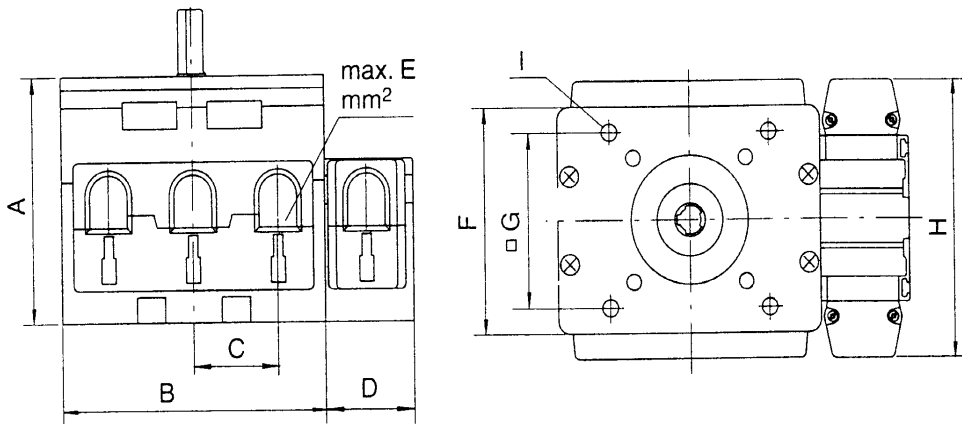

194E-E switch bodies

Type	A	B	C	D	E	F	G	H	I
125	91	112	36	38	95	88	68	108	M5
160	91	112	36	38	95	88	68	108	M5
250	103	145	44	52.5	185	88	68	120	M5
315	103	145	44	52.5	185	88	68	120	M5

Front Mounting, Bolt Terminals 3-, 4 poles

Dimensions [mm]

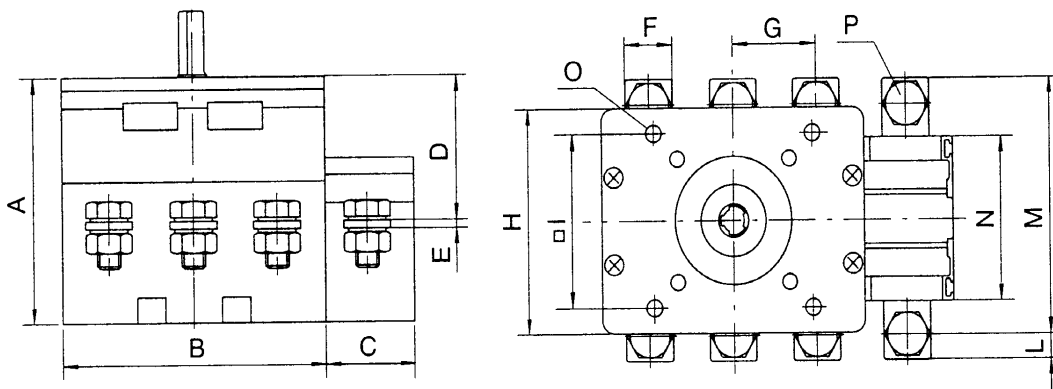

194E-F switch bodies

Type	A	B	C	D	E	F	G	H	I	L	M	N	O	P
125	91	112	38	65.5	3	2	36	88	68	10	90	64	M5	M10
160	91	112	38	65.5	3	2	36	88	68	10	90	64	M5	M10
250	103	145	52.5	60.4	4	2	44	88	68	13	100	70	M5	M12
315	103	145	52.5	60.4	4	-	52	88	68	13	100 105	70	M5	M12

Base Mounting, Box Terminals 3-, 4 poles

Dimensions [mm]

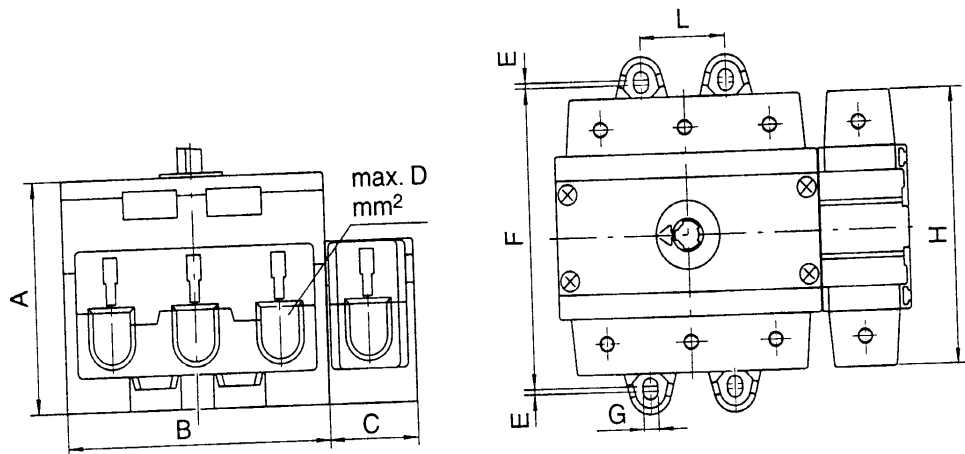

194E-A switch bodies

Type	A	B	C	D	E	F	G	H	I	L
125	91	112	38	95	2	118	6.4	108	64	36
160	91	112	38	95	2	118	6.4	108	64	36
250	98	145	52.5	185	2	140	6.4	126	70	44
315	98	145	52.5	185	2	140	6.4	126	70	44

Base Mounting, Bolt Terminals 3-, 4 poles

Dimensions [mm]

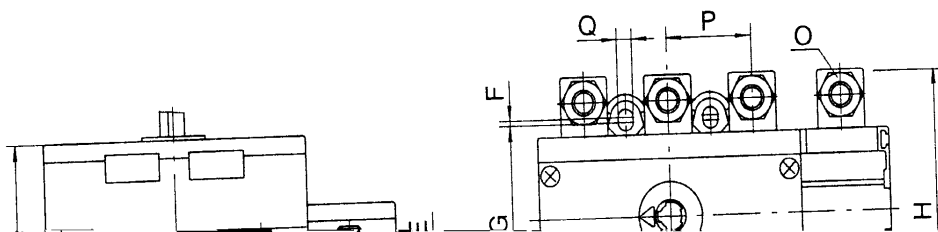

Bulletin 194E
Switch Disconnectors
Dimensions

Ground and Neutral Terminals with Box Terminals

Dimensions [mm]

Front installation

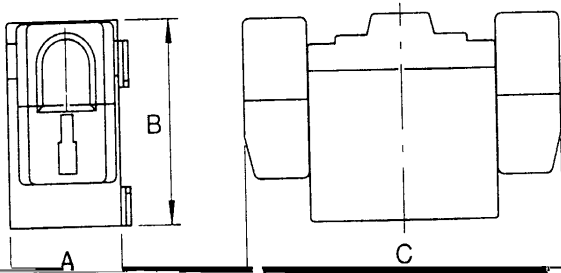

Base mounting

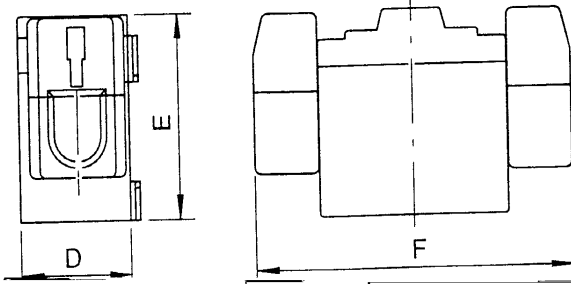

Type	A	B	C	D	E	F
125	37.8	64	108	37.8	64	108
160	37.8	64	108	37.8	64	108
250	52.3	71.1	126	52.3	80.6	126
315	52.3	71.1	126	52.3	80.6	126

Ground and Neutral Terminals with Bolt Terminals

Dimensions [mm]

Front installation

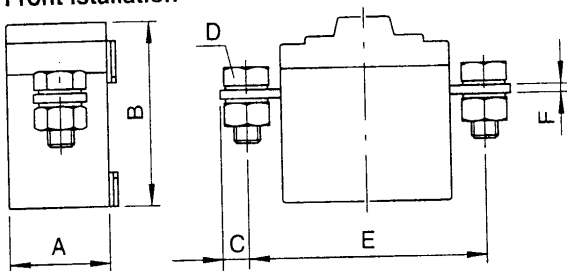

Base mounting

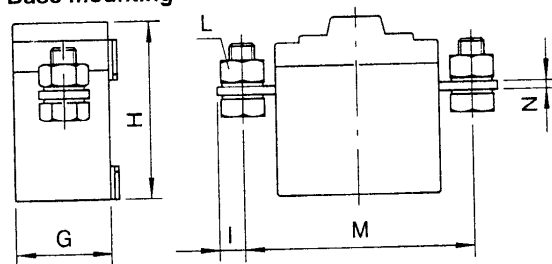

194E-F switch bodies

Type	A	B	C	D	E	F	G	H	I	L	M	N
125	37.8	64	10	M10	90	3	37.8	64	10	M10	90	3
160	37.8	64	10	M10	90	3	37.8	64	10	M10	90	3
250	52.3	68	13	M12	100	4	52.3	68	13	M12	100	4
315	52.3	68	13	M12	100 / 105	4	52.3	68	13	M12	100 / 105	4

Auxiliary switch blocks

Dimensions [mm]

Front installation

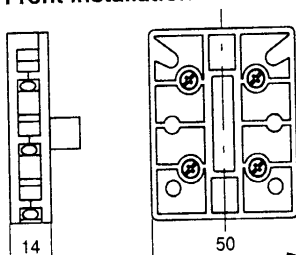

Base mounting

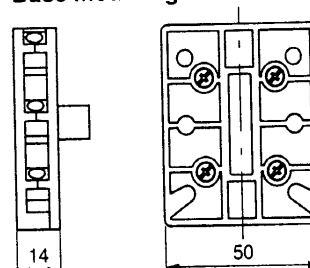

Terminal Covers

Dimensions [mm]

With box terminals

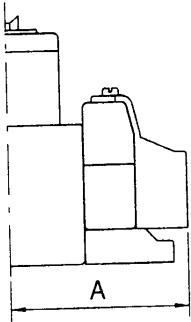

With bolt terminals

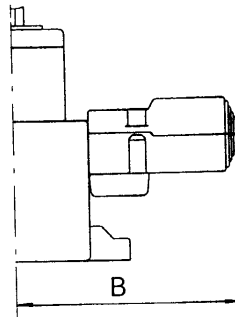

194E-F switch bodies

Type	A	B
125	76.2	95
160	76.2	95
250	88	109.5
315	88	-

Door Clutch

Dimensions [mm]

L for standard shaft
 93...199

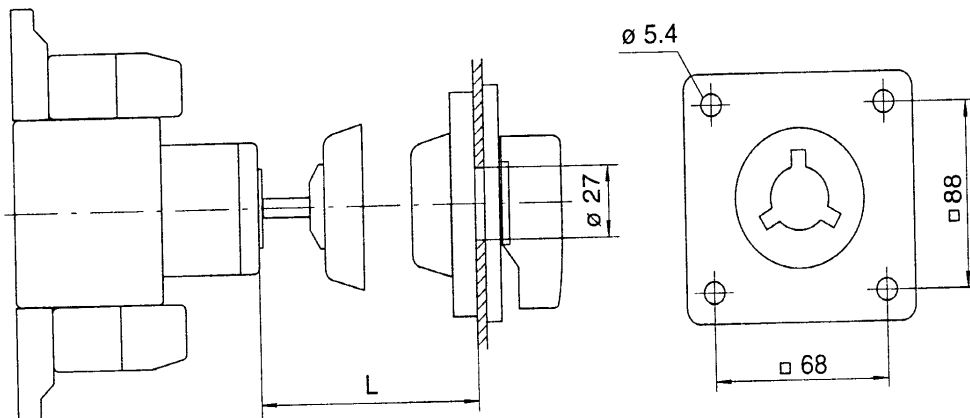

Switch Disconnectors

Dimensions

Actuators, Type 8A, 8I, 8G and 8N

Dimensions [mm]

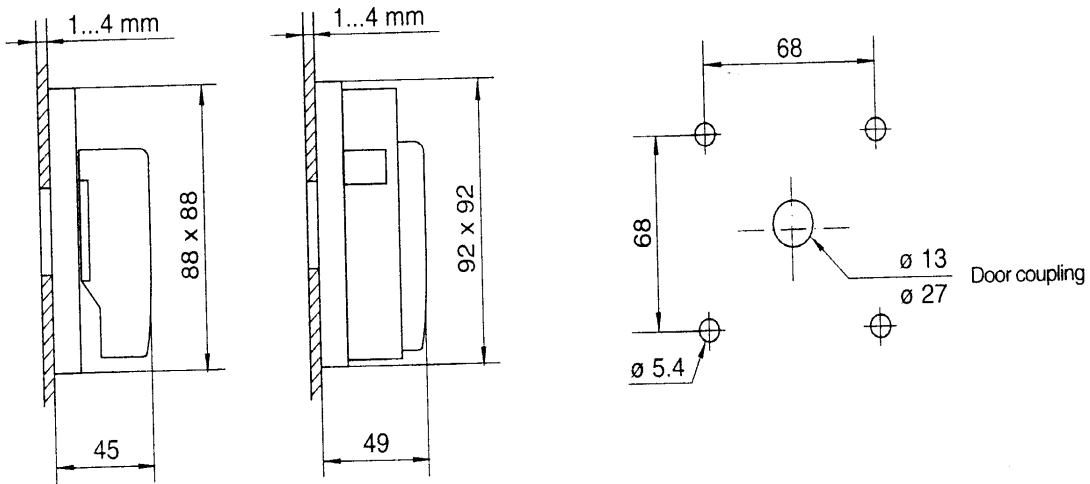

Actuators, Type 13A, 13I, 13G and 13N

Dimensions [mm]

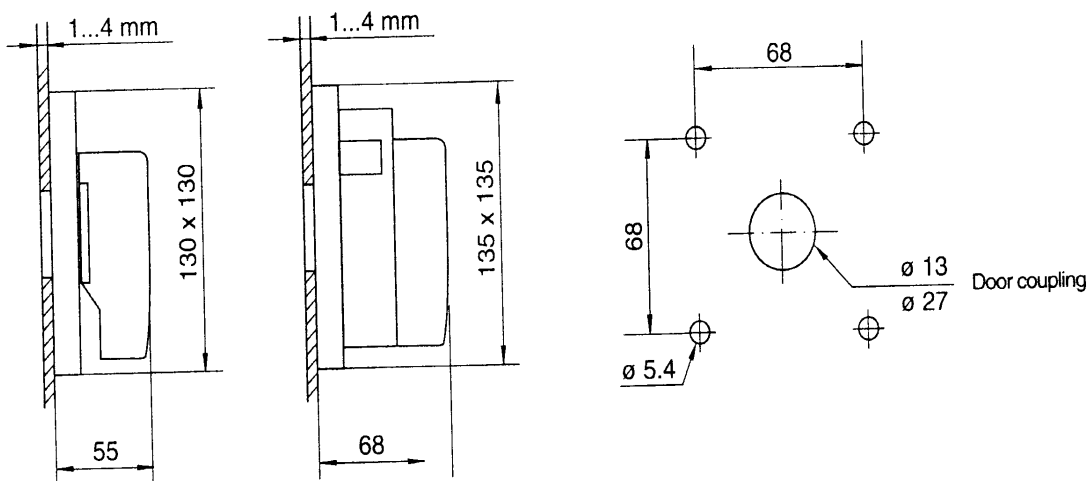

Additional Name Plate

Dimensions [mm]

