

## AXIAL WIREWOUND RESISTORS - AC

### FEATURES

- General purpose resistors
- High power dissipation in small volume
- High pulse load handling capabilities
- High temperature silicone coating
- Non-inductive version available on request
- Low inductive available on request
- Various forming styles available

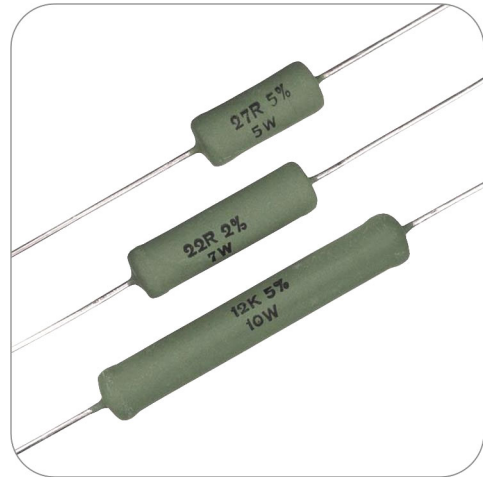

### MARKET SEGMENTS AND APPLICATIONS

MARKET SEGMENT	APPLICATION
Industrial	Power supplies Motor speed controls
Telecom	Line protection resistor Power supplies
Consumer Sound & Vision	Audio Editors Systems High end hi-fi
DAP	Kitchen appliances White good
Lighting	Ballast equipment
Automotive	Dashboard electronics Electronic fuel injection

AC

## TECHNOLOGY

The resistor element is a resistive wire, which is wound, in a single layer, on a ceramic rod. Metal caps are pressed over the ends of the rod. The ends of the resistive wire and the leads are connected to the caps by welding. Tinned copper-clad iron leads with poor heat conductivity are employed permitting the use of relatively short leads to obtain stable mounting without overheating. The resistor is coated with a green silicon cement which is non-flammable, will not drip even at high overloads and is resistant to most commonly used cleaning solvents, in accordance with MIL-STD-202, method 215 and IEC 60068-2-45.

## QUICK REFERENCE DATA

DESCRIPTION	AC01	AC02	AC03	AC04	AC05	AC07	AC10	AC15	AC20
Rated dissipation at $T_{amb} = 40\text{ °C}$	1 W	2 W	3 W	4 W	5 W	7 W	10 W	15 W	20 W
Rated dissipation at $T_{amb} = 70\text{ °C}$	0.9 W	1.8 W	2.5 W	3.5 W	4.7 W	5.8 W	8.4 W	12.5 W	16.0 W
Resistance range <sup>(1)</sup>	0.1 $\Omega$ to 2.4 k $\Omega$	0.1 $\Omega$ to 4.7 k $\Omega$	0.1 $\Omega$ to 5.1 k $\Omega$	0.1 $\Omega$ to 6.8 k $\Omega$	0.1 $\Omega$ to 8.2 k $\Omega$	0.1 $\Omega$ to 15 k $\Omega$	0.68 $\Omega$ to 27 k $\Omega$	0.82 $\Omega$ to 39 k $\Omega$	1.2 $\Omega$ to 56 k $\Omega$
Resistance tolerance <sup>(2)</sup> and series	$\pm 5\%$ ; E24								
Temperature coefficient <sup>(3)</sup>	R < 10 $\Omega$ : + 600 ppm/ $^{\circ}\text{C}$ R $\geq$ 10 $\Omega$ : - 80 to + 140 ppm/ $^{\circ}\text{C}$								
Climatic category (IEC 60068)	40/200/56								
Operating temperature	- 40 $^{\circ}\text{C}$ to + 200 $^{\circ}\text{C}$								
Basic specification	IEC60 115-1								
Rated voltage <sup>(4)</sup>	$\sqrt{P_n \times R}$								
Stability after:									
Load	$\Delta R/R_{max} \pm 5\% + 0.1\ \Omega$								
Soldering	$\Delta R/R_{max} \pm 0.5\% + 0.05\ \Omega$								
Climatic tests	$\Delta R/R_{max} \pm 1\% + 0.05\ \Omega$								
Short time overload	$\Delta R/R_{max} \pm 2\% + 0.1\ \Omega$								

(1) Special resistive values available on request

(2) Tolerances, 1, 3 and 10% available on request

(3) Temperature coefficient 30, 50 and 90 ppm/ $^{\circ}\text{C}$  available on request

(4) Maximum rated voltage is the limiting voltage

**MECHANICAL DATA**

**AXIAL STYLE**

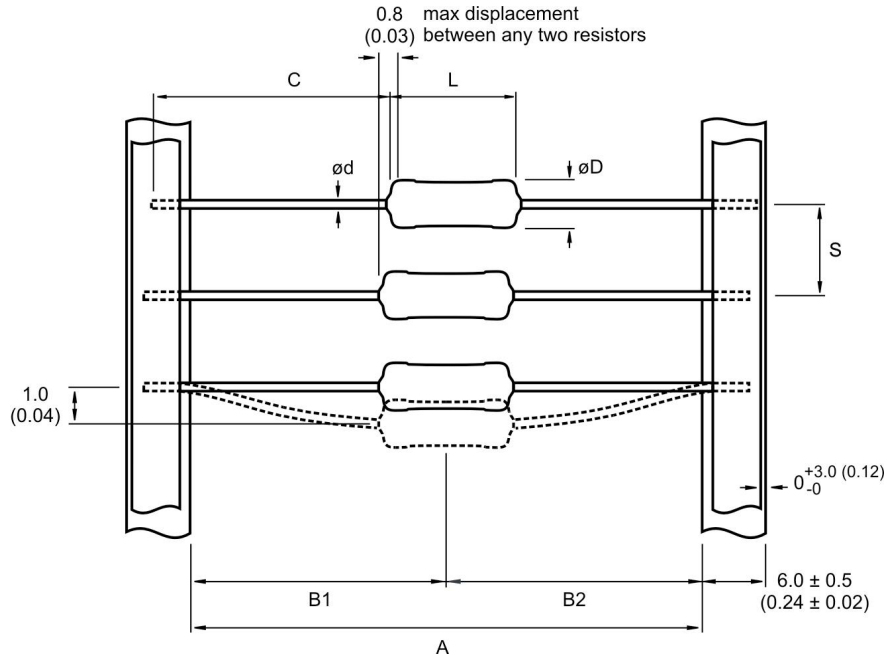

Fig. 1

Table 1. Mechanical data.

TYPE	A	L max	ØD max	C	Ød	B1 - B2  max	S
AC01	63.0 ±2.0 (2.48 ±0.08)	10.0 (0.40)	4.3 (0.17)	32.0 (1.26)	0.80 ±0.03 (0.031 ±0.002)	1.2 (0.05)	10.0 ±0.1 (0.40 ±0.01)
AC02	63.0 ±2.0 (2.48 ±0.08)	13.0 (0.51)	5.5 (0.22)	30.0 (1.18)		1.2 (0.05)	10.0 ±0.1 (0.40 ±0.01)
AC03	63.0 ±2.0 (2.48 ±0.08)	13.0 (0.51)	5.5 (0.22)	30.0 (1.18)		1.2 (0.05)	10.0 ±0.1 (0.40 ±0.01)
AC04	63.0 ±2.0 (2.48 ±0.08)	17.0 (0.67)	5.7 (0.23)	28.0 (1.10)		1.2 (0.05)	10.0 ±0.1 (0.40 ±0.01)
AC05	63.0 ±2.0 (2.48 ±0.08)	17.0 (0.67)	7.5 (0.29)	28.0 (1.10)		1.2 (0.05)	10.0 ±0.1 (0.40 ±0.01)
AC07	73.0 ±2.0 (2.87 ±0.08)	25.0 (0.98)	7.5 (0.29)	28.0 (1.10)		1.2 (0.05)	10.0 ±0.1 (0.40 ±0.01)
AC10	89.0 ±2.0 (3.50 ±0.08)	44.0 (1.73)	8 (0.32)	28.0 (1.10)		1.2 (0.05)	10.0 ±0.1 (0.40 ±0.01)
AC15	-	51.0 (2.01)	10 (0.39)	28.0 (1.10)		-	-
AC20	-	67.0 (2.64)	10 (0.39)	28.0 (1.10)		-	-

Dimensions unless specified in mm (inches)

**AC**

**ELETRICAL CHARACTERISTICS**

**DERATING**

The power that the resistor can dissipate depends on the operating temperature.

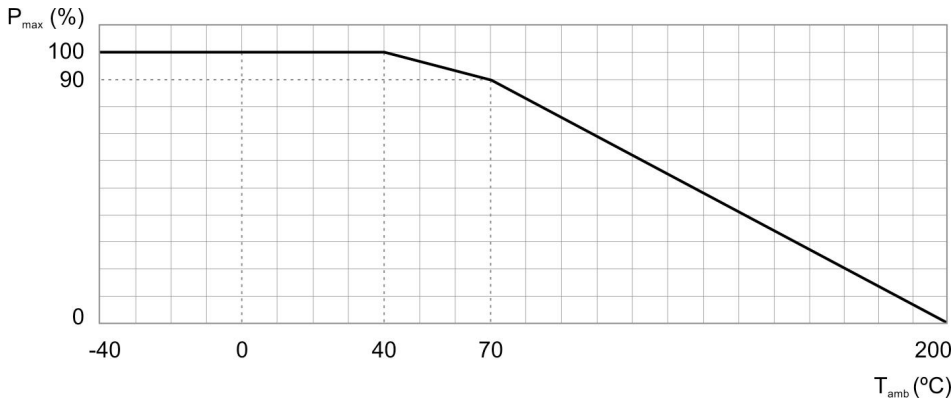

Fig. 2 Maximum dissipation (P<sub>max</sub>) in percentage of rated as a function of ambient temperature (T<sub>amb</sub>)

**APPLICATION INFORMATION**

Hot spot

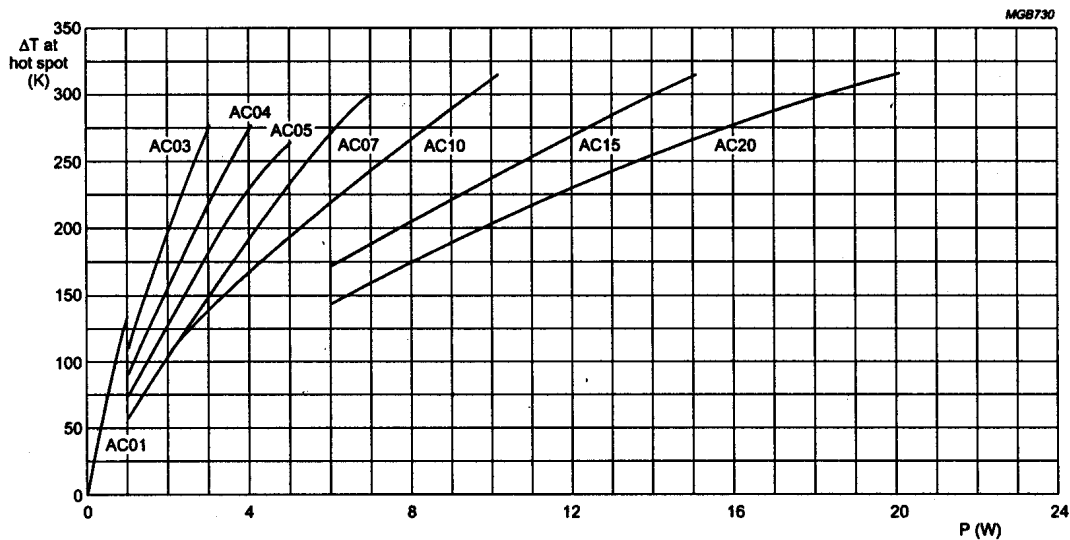

Fig. 3 Hot spot temperature rise (ΔT) as a function of dissipated power.

Solder spot lead length as a function of the dissipation with as a parameter the temperature rise at the end of lead (soldering spot).

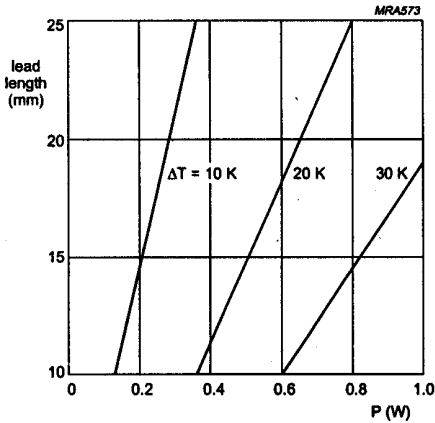

Fig. 4 AC01

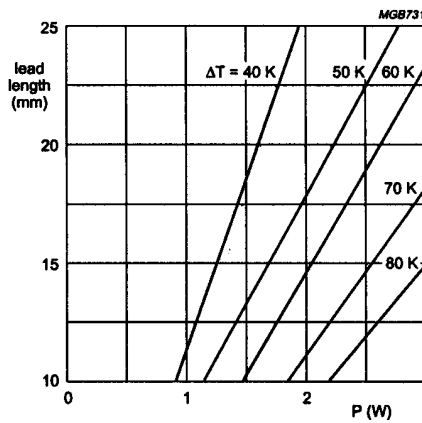

Fig. 5 AC02

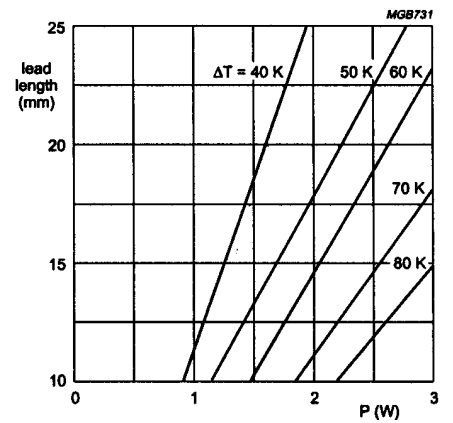

Fig. 6 AC03

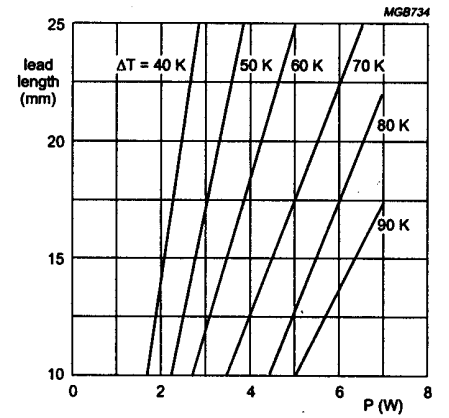
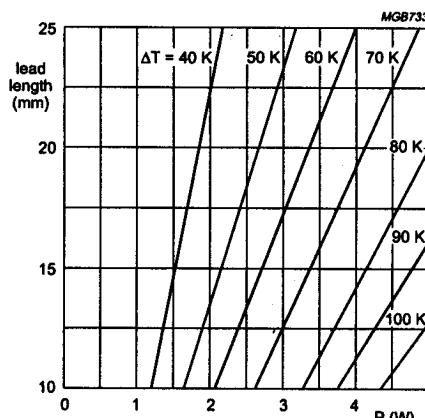
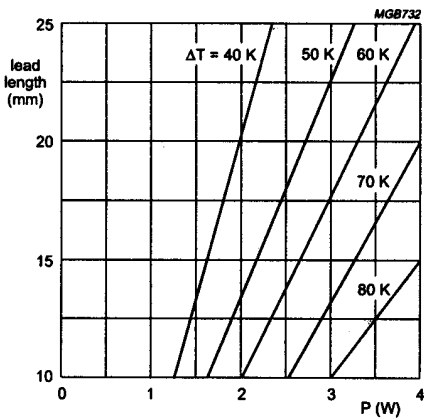

Fig. 9 AC07

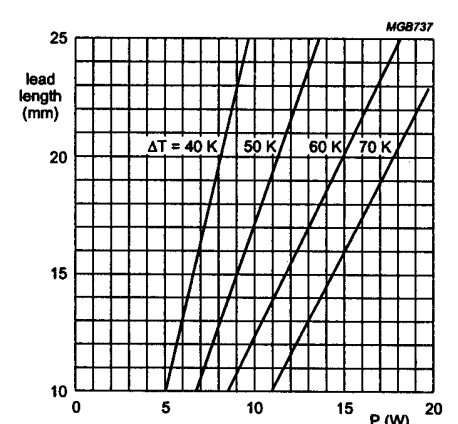
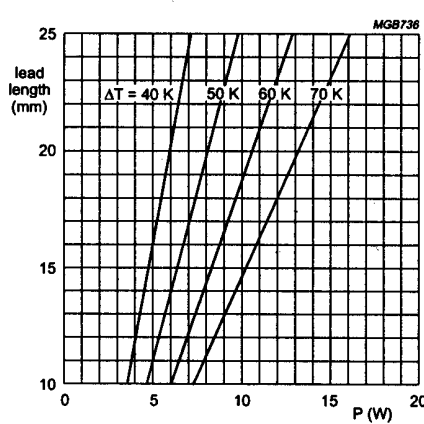
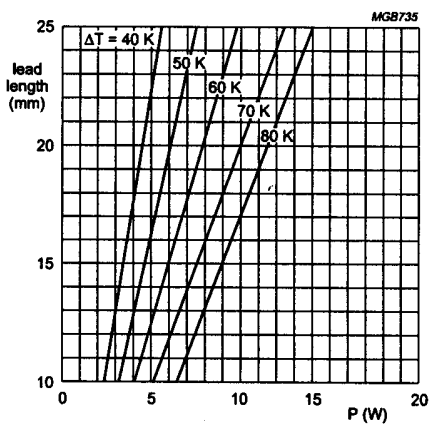

Fig. 12 AC20

AC

## PULSE LOAD CAPABILITIES

How to generate the maximum allowed pulse-load from the graphs composed for wire wound resistors of the AC-types.

### SINGLE PULSE CONDITION

If the applied pulse energy in joules or wattseconds is known and also the R-value to be used in the application; take the R-value on the X-axis and go vertically to the curved line. From this point go horizontally to the Y-axis, this point gives the maximum allowed pulse energy in joules/ohm or wattseconds. If this figure is higher than the applied pulse energy the application is allowed. Otherwise take one of the other graphs belonging to AC-types with higher  $P_n$ .

If, contrary to the information above, the applied peak-voltage and impulse times  $t_i$  are known. Calculate the pulse-voltage ( $E_p$ ) in joules or wattseconds by the use of the following formula:

$$E_p = [(V_p^2 / R) \times t_i] \quad (V_p = \text{peak voltage}; t_i = \text{impulse-time})$$

By dividing this result with the  $R_n$ -value of the R in use, gives the value wattseconds/ohm on the Y-axis. Draw a line horizontally to the curved line and the intersection the vertical line on the X-axis gives the maximum allowed  $R_n$ -value to be used in the application. If this  $R_n$ -value is higher than the R-value to be used in the application, the application is allowed. If not, take one of the other graphs belonging to AC-types with higher  $P_n$  or change the  $R_n$ -value to be used.

### REPETITIVE PULSE CONDITION

With these graphs we can determine the allowed pulse energy in watt depending on the impulse-time  $t_i$  and the repetition time  $t_p$  of the pulses. The parameter is the Resistance Value. If the pulse shape is known (impulse-time  $t_i$  and repetition time  $t_p$ ), draw a line vertically from the X-axis at the mentioned  $t_i$  to the line of the involved  
R-value.

From the intersection the horizontal line to the Y-axis indicates the maximum allowed pulse load at a certain  $t_p/t_i$ .

If the vertical line from the X-axis crosses the applied  $t_p/t_i$  before reaching the R-line, this  $t_p/t_i$  line gives the maximum allowed pulse energy at the Y-axis. If the applied pulse energy is known (in watts) and the impulse-time  $t_i$  also, draw a line horizontally from the Y-axis to the crossing with the pulse line ( $t_i$ ) and find the possible

R-value needed in this application. The horizontal  $t_p/t_i$  lines give the maximum allowed pulse load till they reach the R-line, that point indicates the maximum allowed impulse-time  $t_i$  at the horizontal axis.

AC01 - SINGLE PULSE

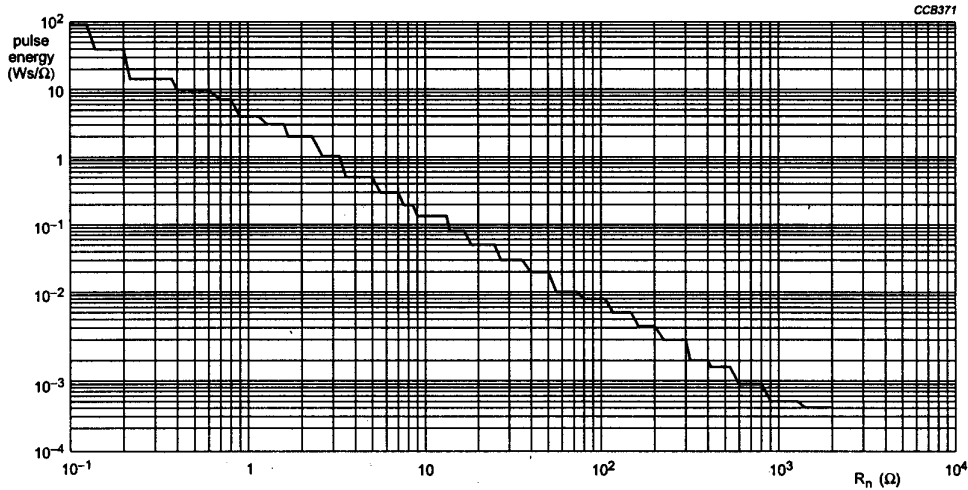

Fig. 13 Pulse capability; Ws as a function of Rn

AC01 - REPETITIVE PULSE

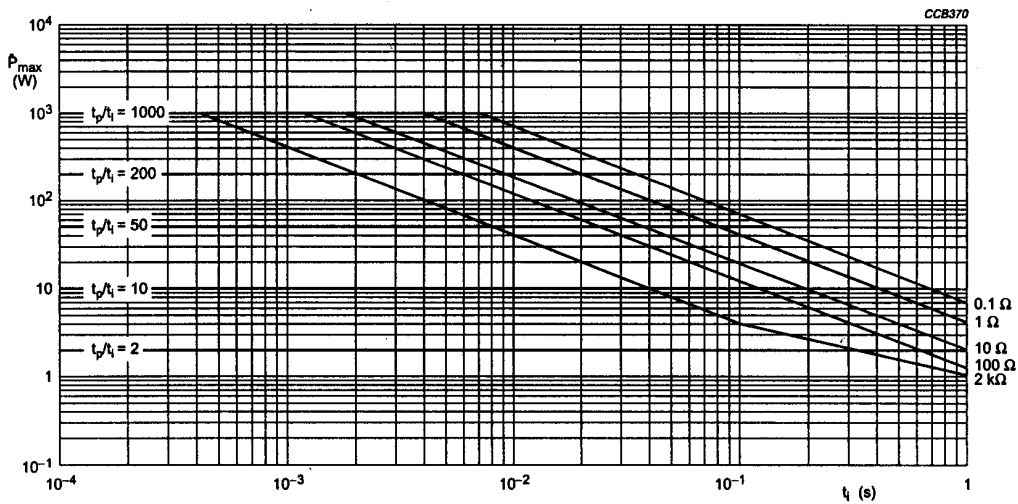

Fig. 14 Pulse on regular basis; maximum permissible peak pulse power ( $P_{max}$ ) as a function of pulse duration ( $t_i$ )

AC01

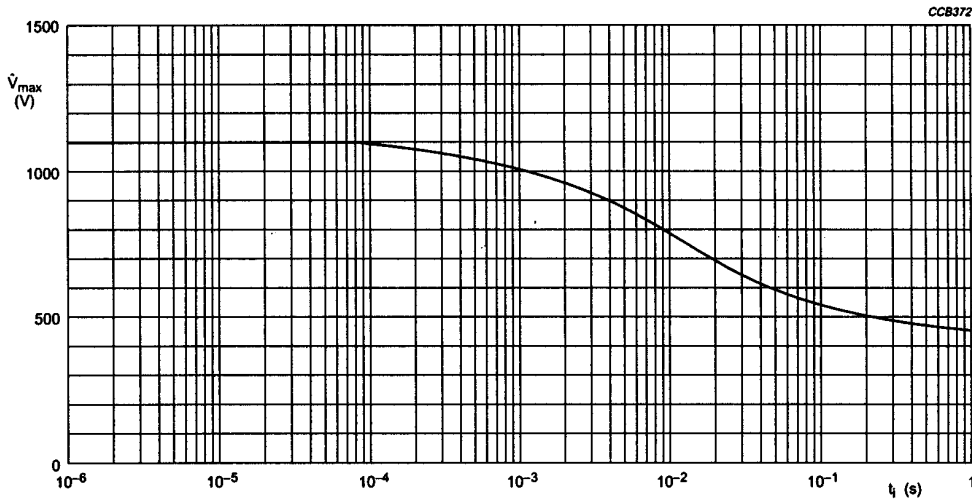

Fig. 15 Pulse on regular basis; maximum permissible peak pulse voltage ( $V_{max}$ ) as a function of pulse duration ( $t_i$ )

AC02 - SINGLE PULSE

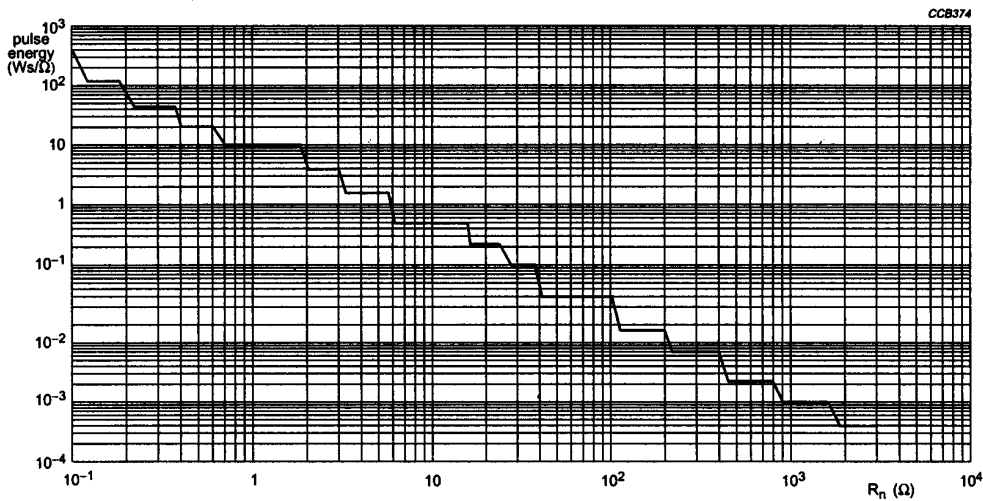

Fig. 16 Pulse capability; Ws as a function of  $R_n$



AC02 - REPETITIVE PULSE

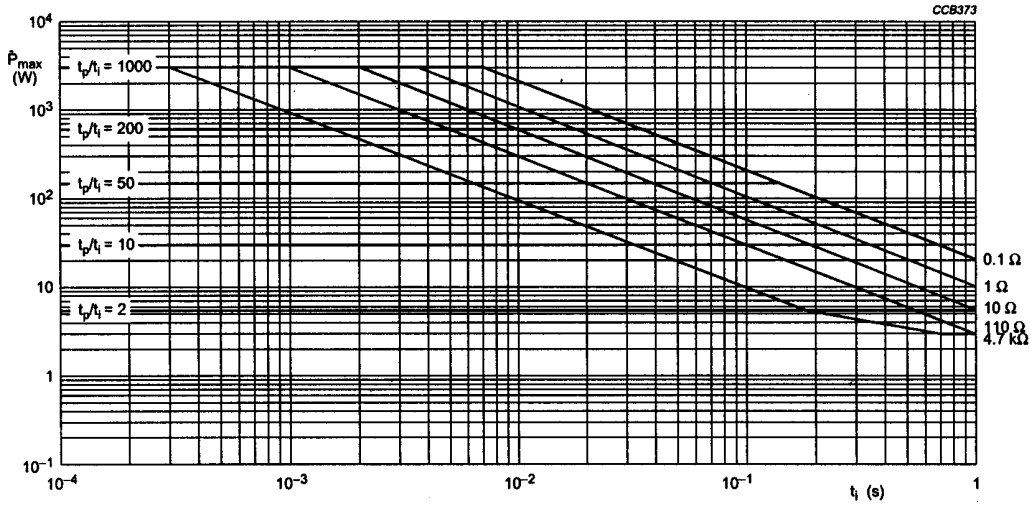

Fig. 17 Pulse on regular basis; maximum permissible peak pulse power ( $P_{max}$ ) as a function of pulse duration ( $t_i$ )

AC02

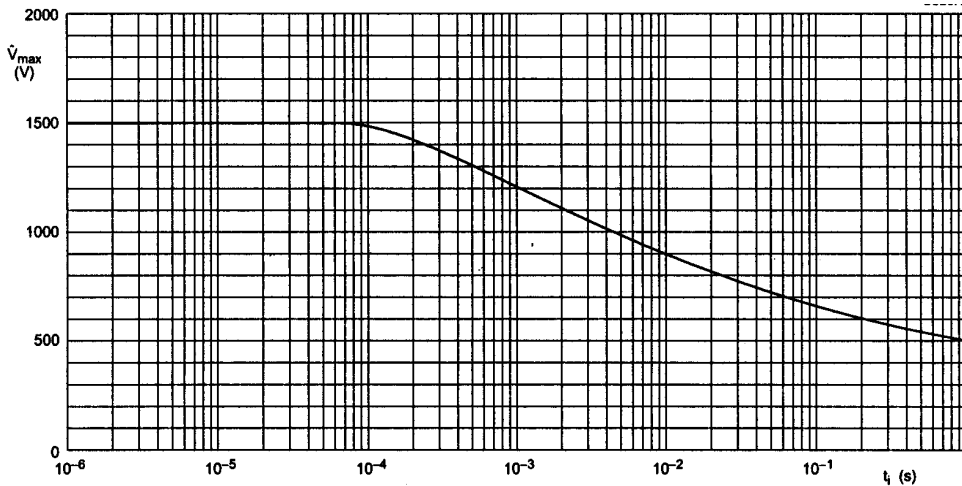

Fig. 18 Pulse on regular basis; maximum permissible peak pulse voltage ( $V_{max}$ ) as a function of pulse duration ( $t_i$ )

AC03 - SINGLE PULSE

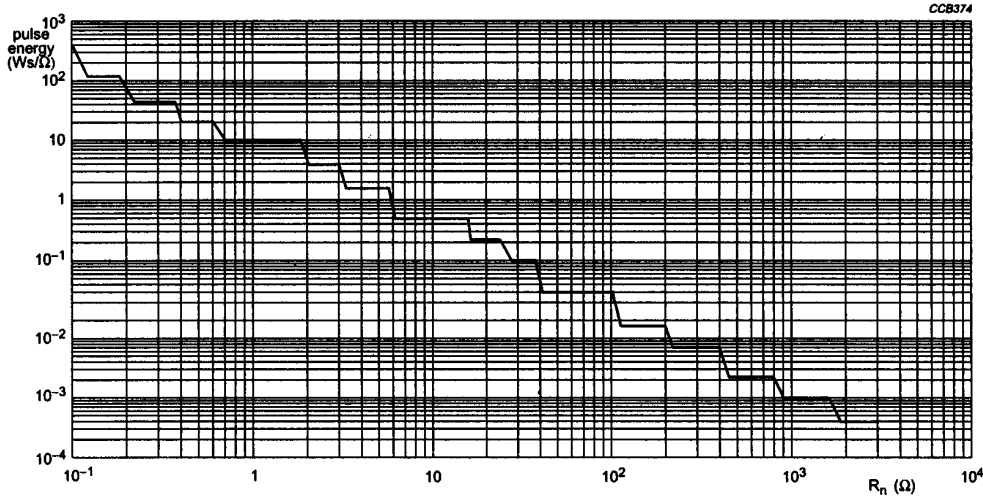

Fig. 19 Pulse capability; Ws as a function of Rn

AC03 - REPETITIVE PULSE

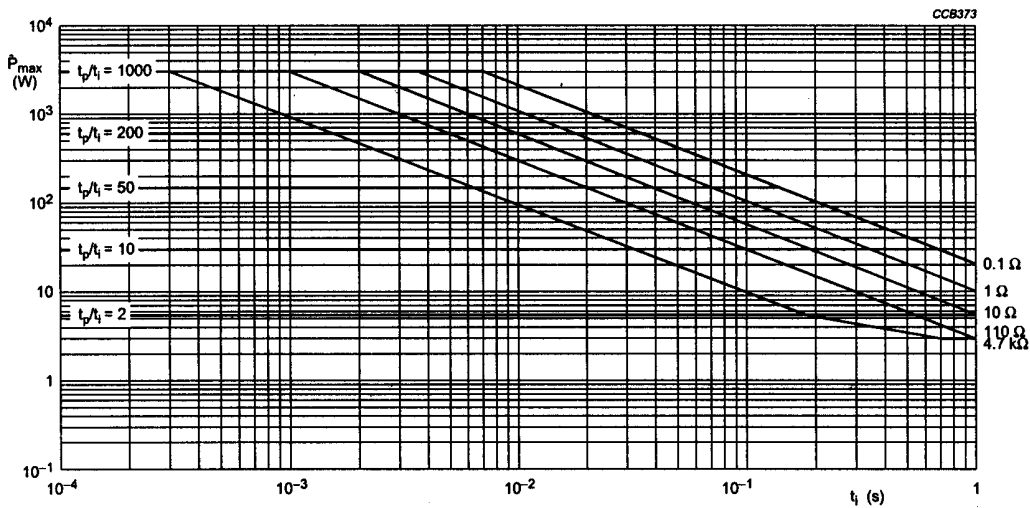

Fig. 20 Pulse on regular basis; maximum permissible peak pulse power ( $P_{max}$ ) as a function of pulse duration ( $t_i$ )

AC03

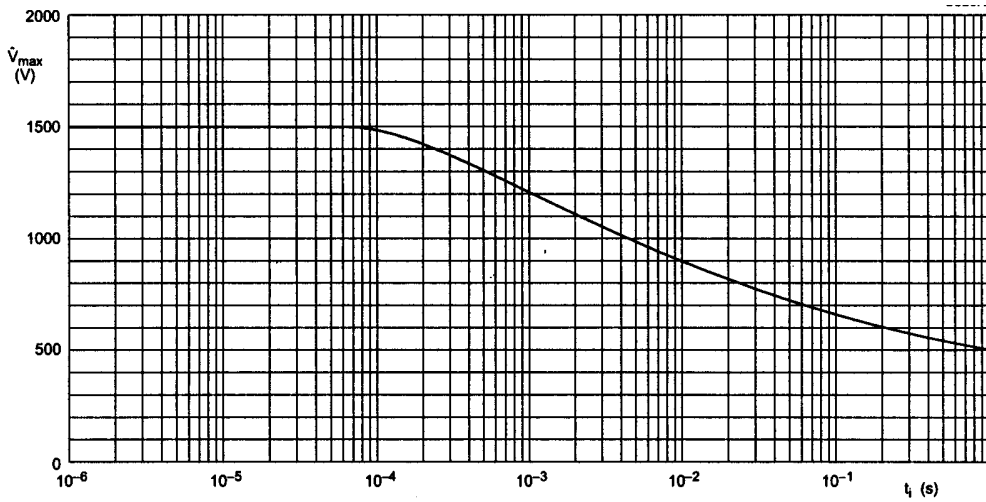

Fig. 21 Pulse on regular basis; maximum permissible peak pulse voltage ( $V_{max}$ ) as a function of pulse duration ( $t_i$ )

AC04 - SINGLE PULSE

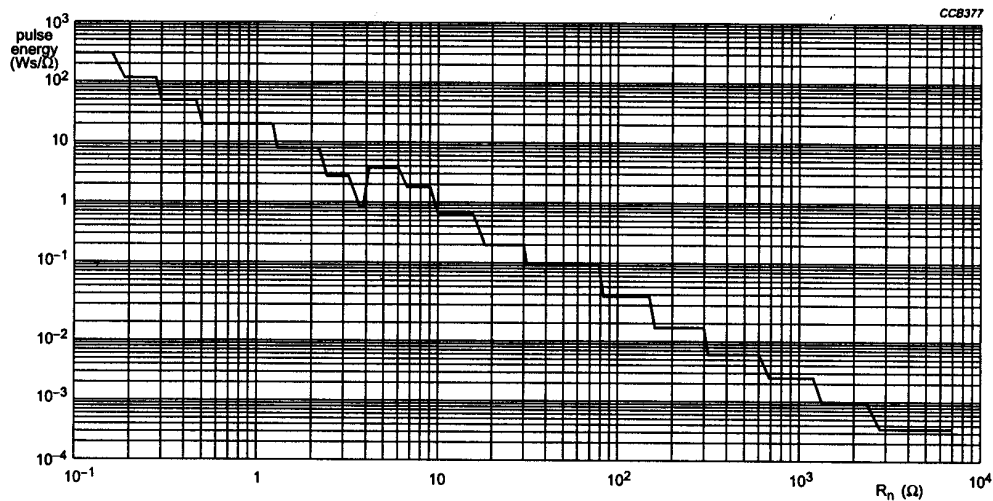

Fig. 22 Pulse capability;  $W_s$  as a function of  $R_n$

AC04 - REPETITIVE PULSE

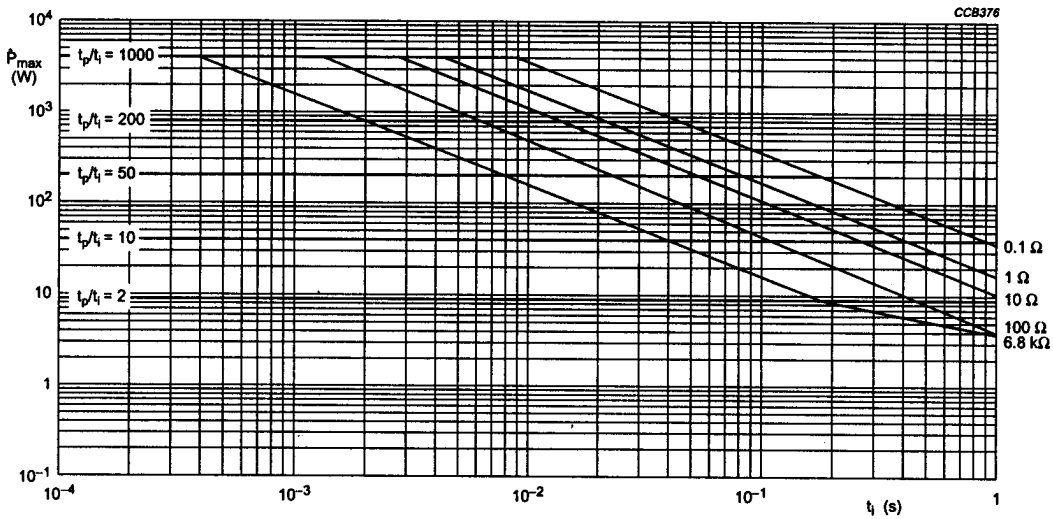

Fig. 23 Pulse on regular basis; maximum permissible peak pulse power ( $P_{max}$ ) as a function of pulse duration ( $t_i$ )

AC04

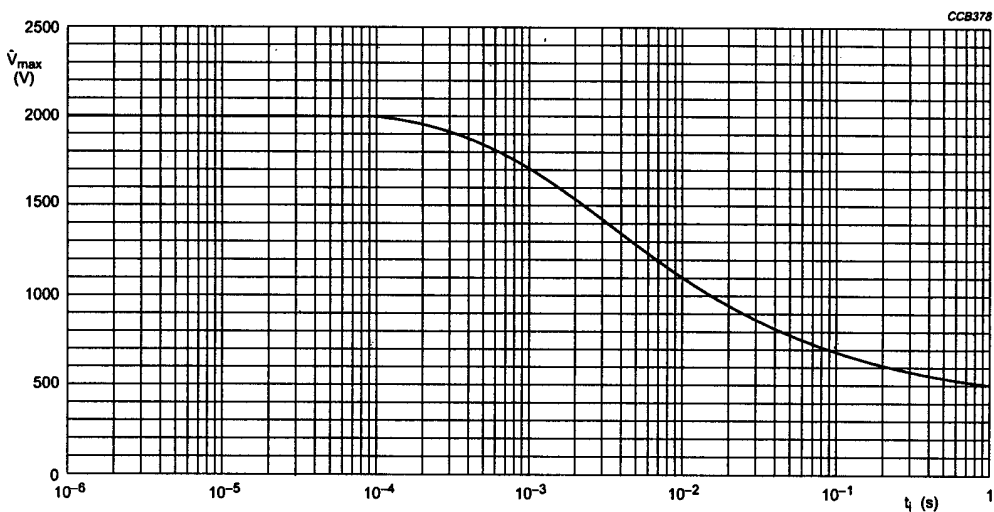

Fig. 24 Pulse on regular basis; maximum permissible peak pulse voltage ( $V_{max}$ ) as a function of pulse duration

AC05 - SINGLE PULSE

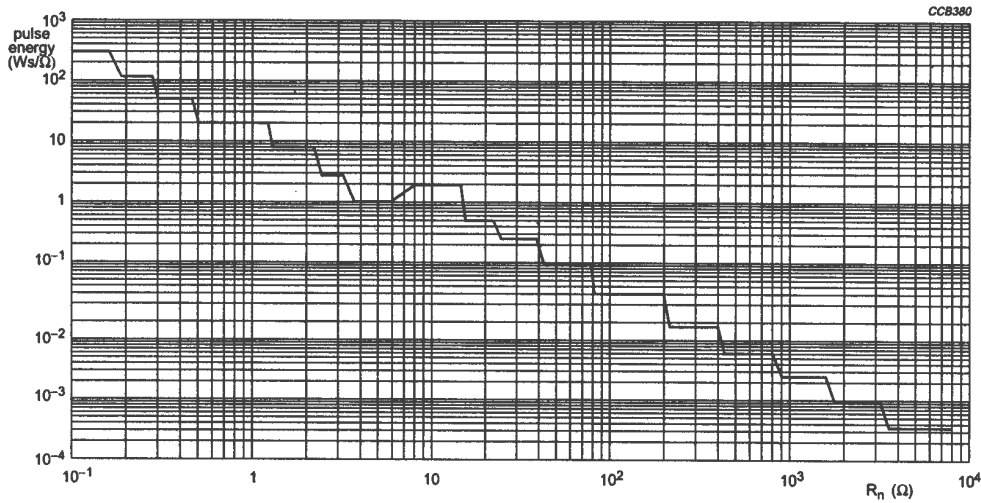

Fig. 25 Pulse capability;  $W_s$  as a function of  $R_n$

AC05 - REPETITIVE PULSE

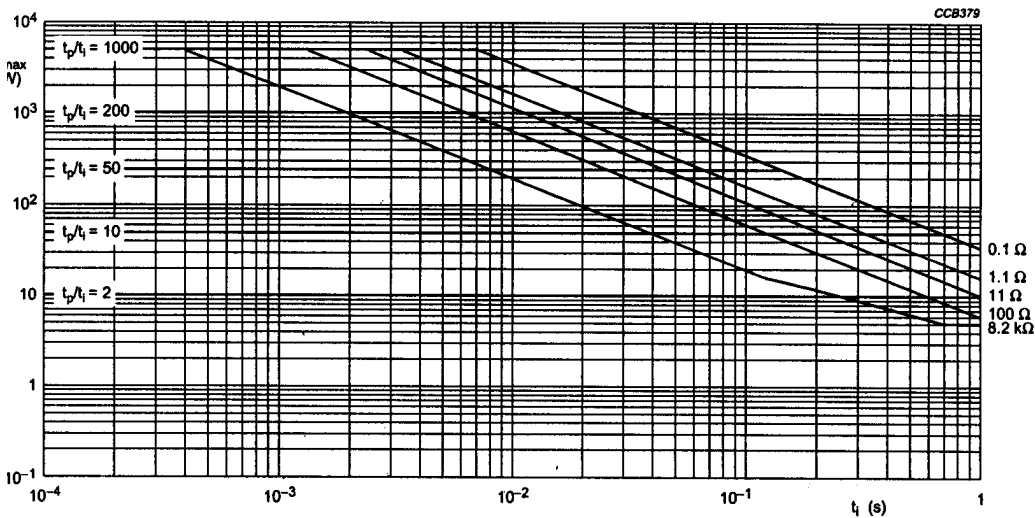

Fig. 26 Pulse on regular basis; maximum permissible peak pulse power ( $P_{max}$ ) as a function of pulse duration ( $t_i$ )

AC05

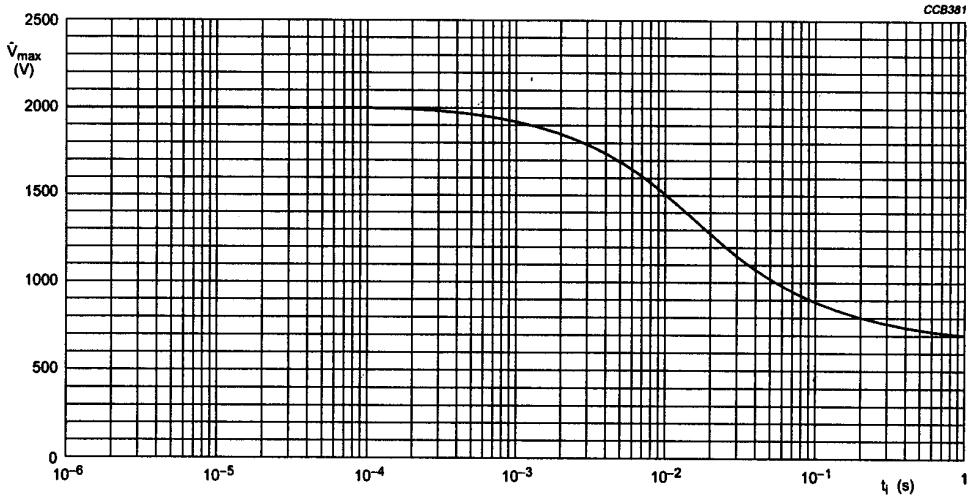

Fig. 27 Pulse on regular basis; maximum permissible peak pulse voltage ( $V_{max}$ ) as a function of pulse duration ( $t_i$ )

AC07 - SINGLE PULSE

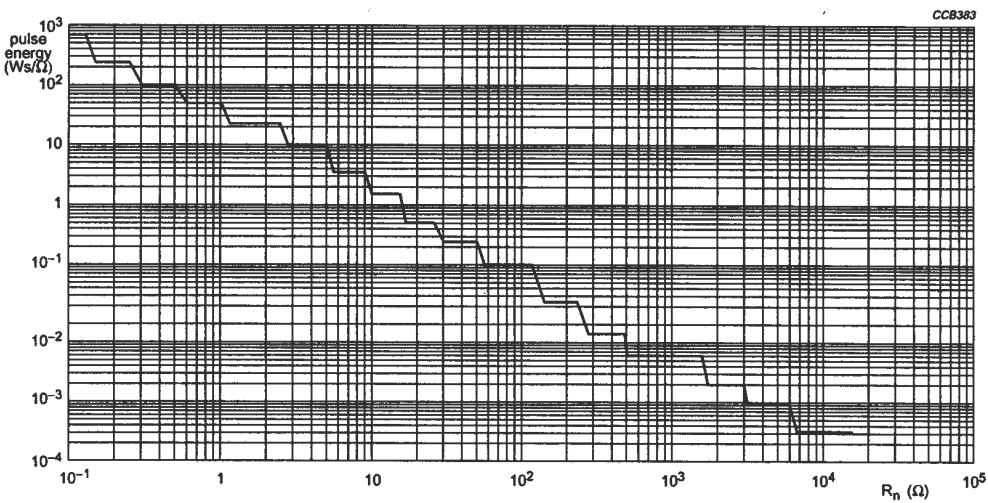

Fig. 28 Pulse capability;  $W_s$  as a function of  $R_n$

AC07 - REPETITIVE PULSE

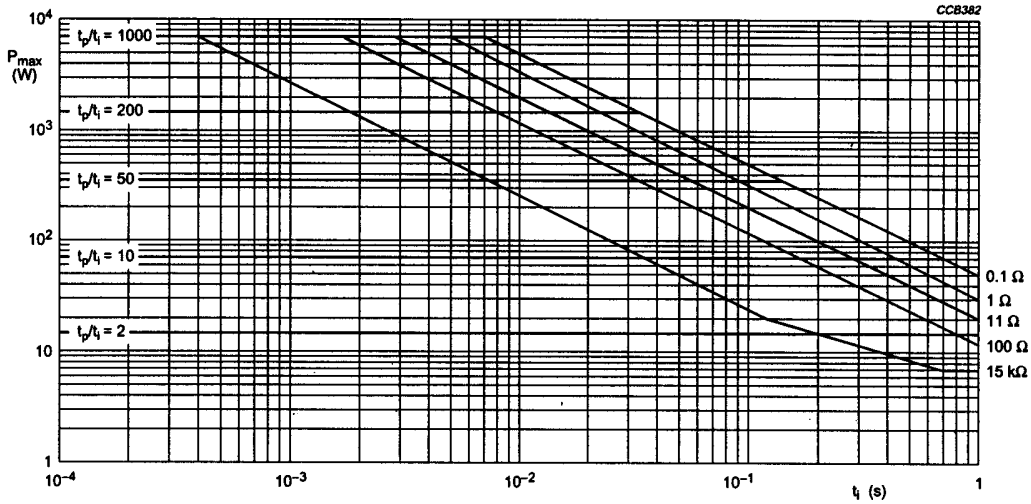

Fig. 29 Pulse on regular basis; maximum permissible peak pulse power ( $P_{max}$ ) as a function of pulse duration ( $t_i$ )

AC07

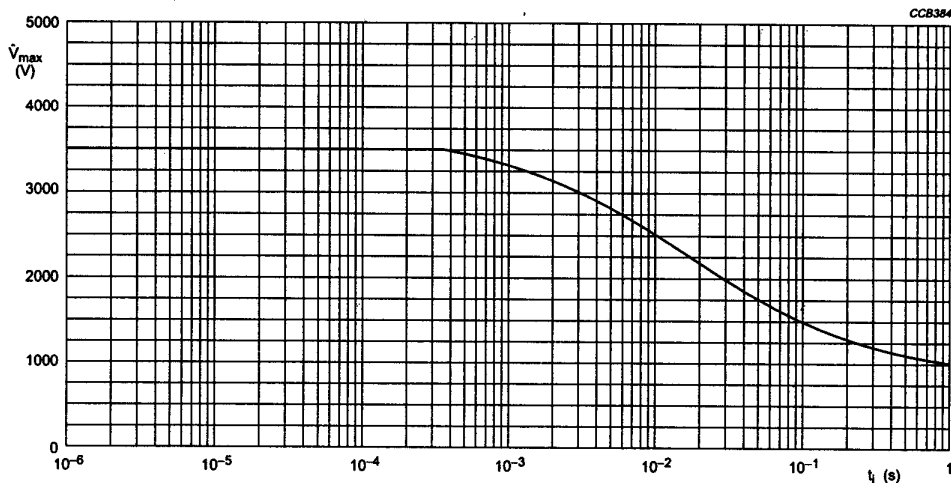

Fig. 30 Pulse on regular basis; maximum permissible peak pulse voltage ( $V_{max}$ ) as a function of pulse duration ( $t_i$ )



AC10 - SINGLE PULSE

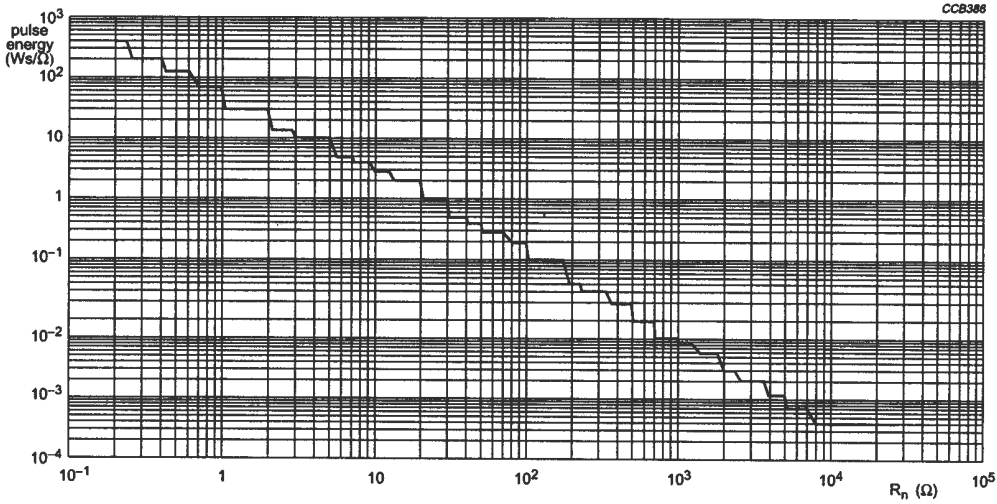

Fig. 31 Pulse capability;  $W_s$  as a function of  $R_n$

AC10 - REPETITIVE PULSE

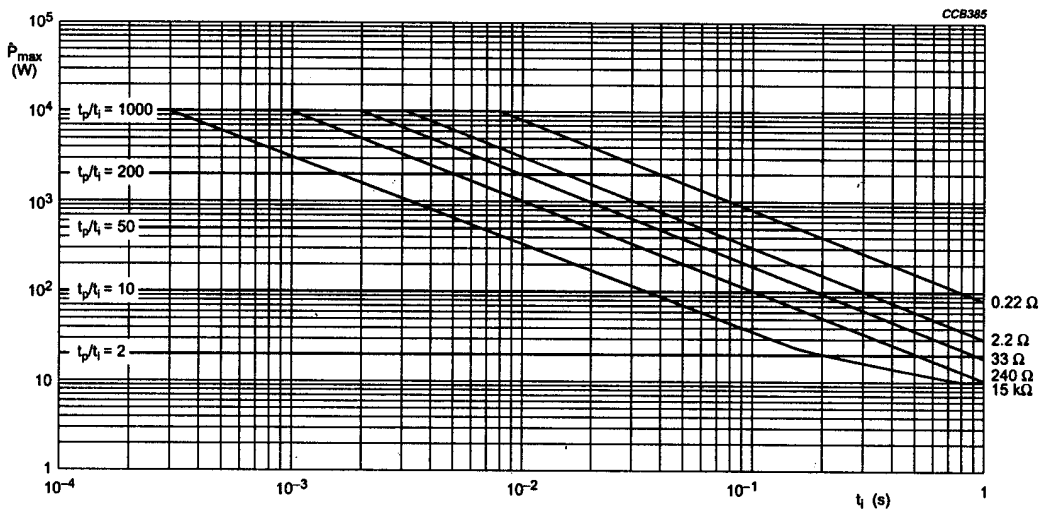

Fig. 32 Pulse on regular basis; maximum permissible peak pulse power ( $P_{max}$ ) as a function of pulse duration ( $t_i$ )



AC10

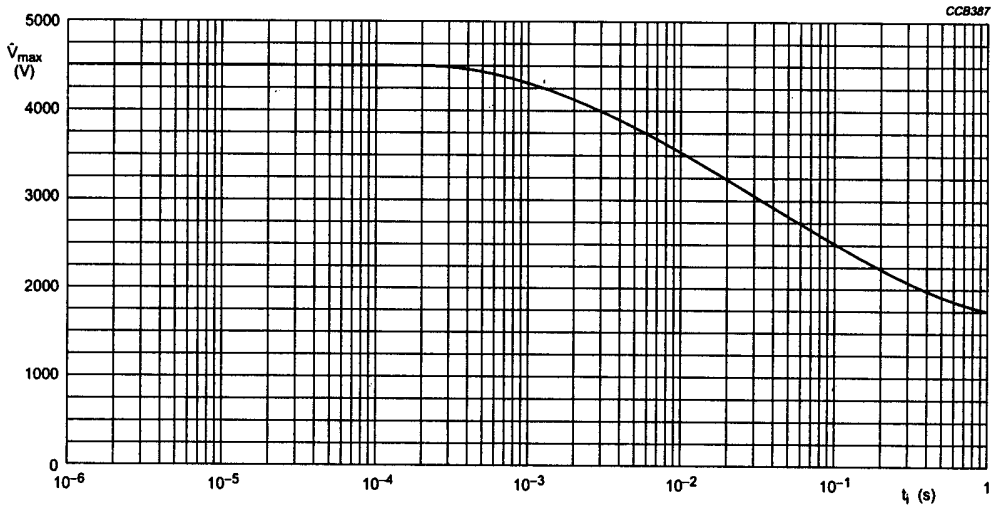

Fig. 33 Pulse on regular basis; maximum permissible peak pulse voltage ( $V_{max}$ ) as a function of pulse duration ( $t_i$ )

AC15 - SINGLE PULSE

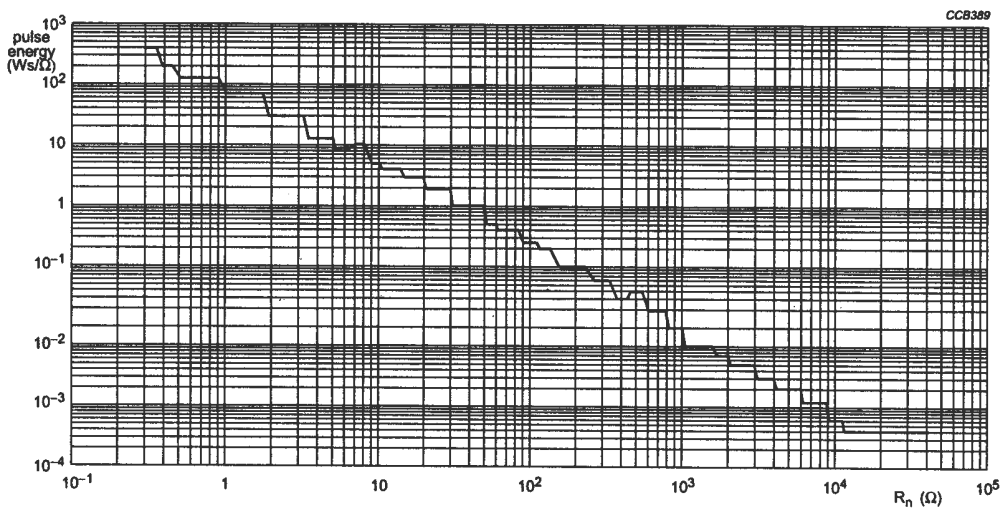

Fig. 34 Pulse capability;  $W_s$  as a function of  $R_n$

AC15 - REPETITIVE PULSE

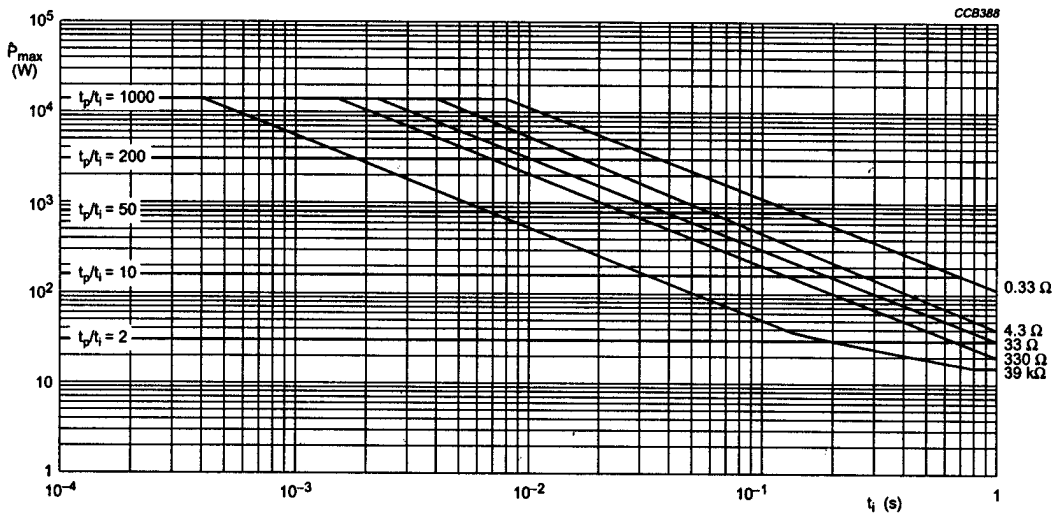

Fig. 35 Pulse on regular basis; maximum permissible peak pulse power ( $P_{max}$ ) as a function of pulse duration ( $t_i$ )

AC15

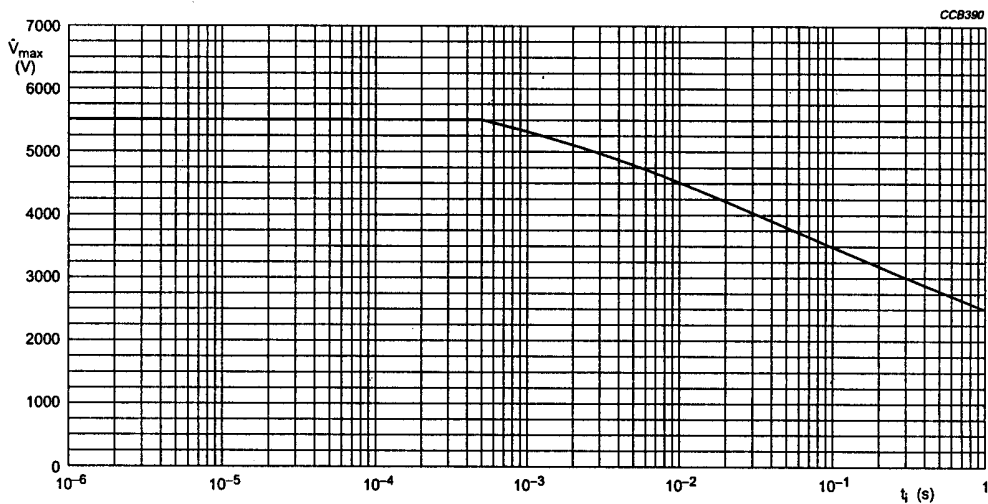

Fig. 36 Pulse on regular basis; maximum permissible peak pulse voltage ( $V_{max}$ ) as a function of pulse duration ( $t_i$ )

AC20 - Single Pulse

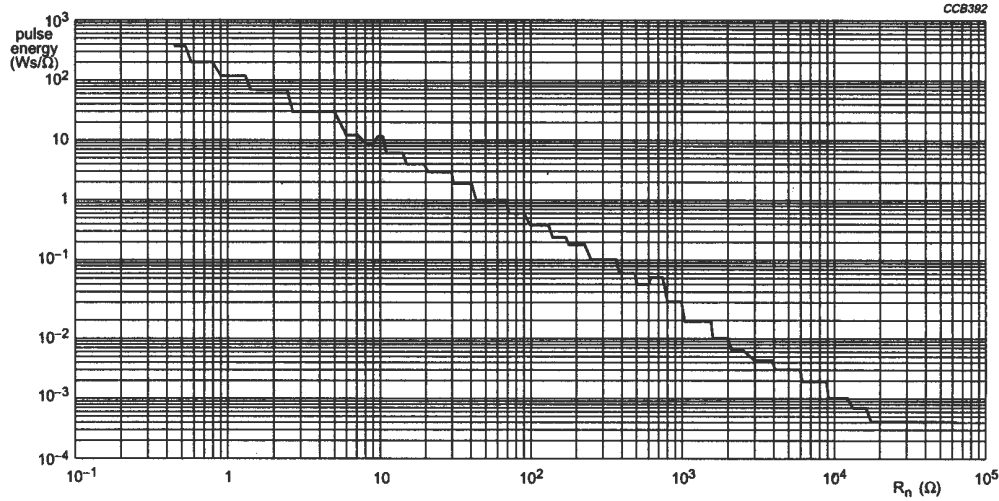

Fig. 37 Pulse capability;  $W_s$  as a function of  $R_n$

AC20 - Repetitive Pulse

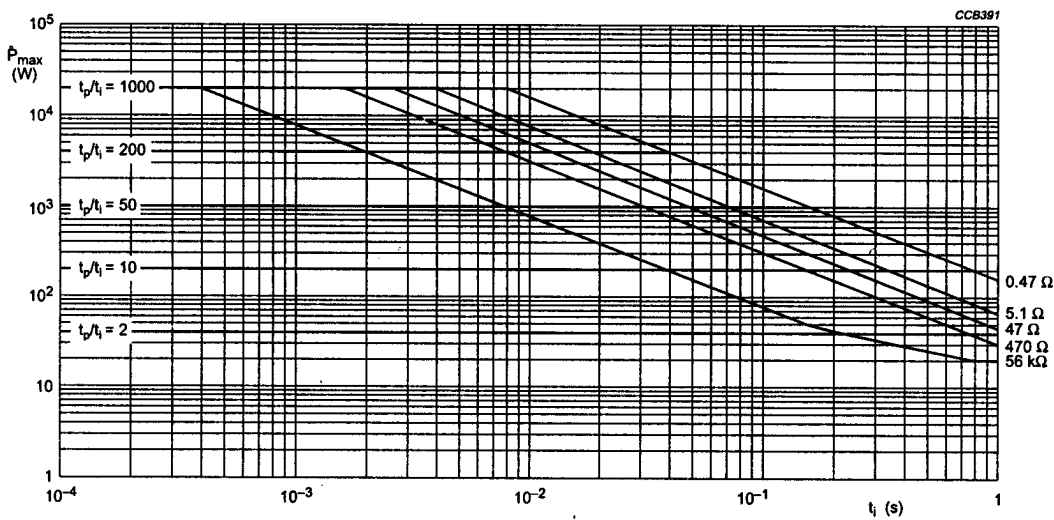

Fig. 38 Pulse on regular basis; maximum permissible peak pulse power ( $P_{max}$ ) as a function of pulse duration ( $t_i$ )

AC20

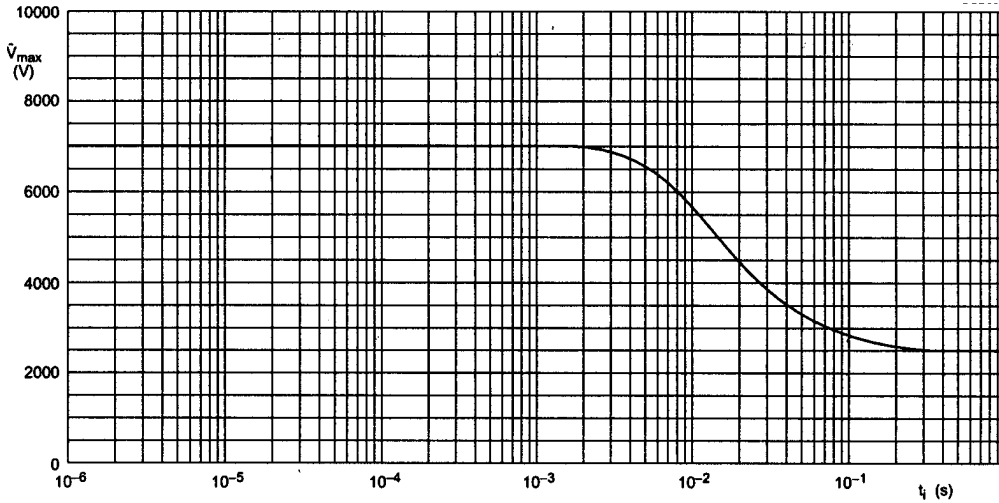

Fig. 39 Pulse on regular basis; maximum permissible peak pulse voltage ( $V_{max}$ ) as a function of pulse duration ( $t_i$ )

Application information available on request

1 - High frequency behaviour (self inductance)

**MARKING**

The resistor is marked with the nominal resistance value, the tolerance on the resistance and the rated dissipation at  $T_{amb} = 40\text{ }^\circ\text{C}$ .

For values up to  $910\ \Omega$ , the R is used as the decimal point.

For values of  $1\ \text{k}\Omega$  and upwards, the letter K is used as the decimal point for the  $\text{k}\Omega$  indication.

Example:

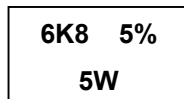

**ORDERING INFORMATION**

The resistors have a 12 digit ordering code indicating the resistor type and resistive value.

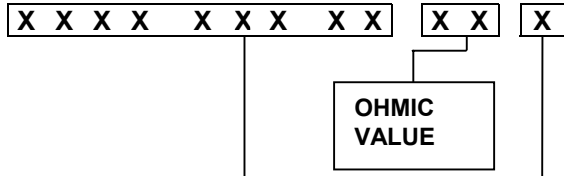

PRODUCT TYPE	ORDERING CODE
AC01	2306 328 33
AC02	2306 326 33
AC03	2322 329 03
AC04	2322 329 04
AC05	2322 329 05
AC07	2322 329 07
AC10	2322 329 10
AC15	2322 329 15
AC20	2322 329 20

NUMBER	RESISTANCE DECADE
7	0.1 - 0.976 Ω
8	1 - 9.76 Ω
9	10 - 97.6 Ω
1	100 - 976 Ω
2	1 - 9.76 kΩ
3	10 - 12 kΩ

Example:

AC01, 47 Ω, ±5% is 2306 328 33479

**NAFTA ORDERING INFORMATION**

Table 2. NAFTA Ordering code.

LEAD Ø	QTY pcs	TOL	TAPING	PACKAGING	NAFTA ORDERING CODE
0.80 (0.031)	1000	±5%	63.0 ±2.0 (2.48 ±0.08)	AMMOPACK	AC01WxxxxxJ
	500			AMMOPACK	AC02WxxxxxJ
	500			AMMOPACK	AC03WxxxxxJ
	500			AMMOPACK	AC04WxxxxxJ
	500			AMMOPACK	AC05WxxxxxJ
	500		73.0 ±2.0 (2.87 ±0.08)	AMMOPACK	AC07WxxxxxJ
	500		89.0 ±2.0 (3.50 ±0.08)	AMMOPACK	AC10WxxxxxJ
	100		-	BOX	AC15WxxxxxJ
	100		-	BOX	AC20WxxxxxJ

Dimensions unless specified in mm (inches)

**AC**

The ohmic value in the NAFTA ordering code (see table 2) is represented by the “xxxxx” in the middle of the above ordering code. Table 3 gives some examples how to use these 5 digits.

**COMPOSITION OF OHMIC VALUE**

Table 3. Ohmic value examples.

VALUE	5 DIGITS
1 Ω	1R000
10 Ω	10R00
100 Ω	100R0
1 kΩ	1K000
10 kΩ	10K00
100 kΩ	100K0
1 MΩ	1M000

Example:

AC01, 47 Ω, ±5% is AC01W47R00J

**PACKAGING**

**TAPE IN BOX**

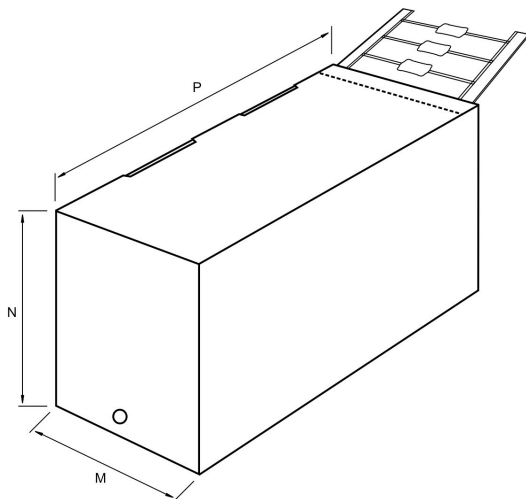

Dimensions unless specified in mm (inches)

Table 4. Box.

PRODUCT	M	N	P	QTY dcs
AC01	85 (3.6)	60 (2.4)	263 (10.6)	1000
AC02	85 (3.6)	77 (3.1)	259 (10.2)	500
AC03	85 (3.6)	77 (3.1)	259 (10.2)	500
AC04	85 (3.6)	77 (3.1)	259 (10.2)	500
AC05	85 (3.6)	112 (4.5)	259 (10.2)	500
AC07	93 (3.7)	115 (4.6)	259 (10.2)	500
AC10	110 (4.4)	117 (4.7)	275 (10.9)	500
AC15	140 (5.5)	60 (2.4)	335 (13.2)	100
AC20	140 (5.5)	60 (2.4)	335 (13.2)	100

**AC**

**TAPE IN REEL (SPECIAL PART NUMBER UNDER REQUEST)**

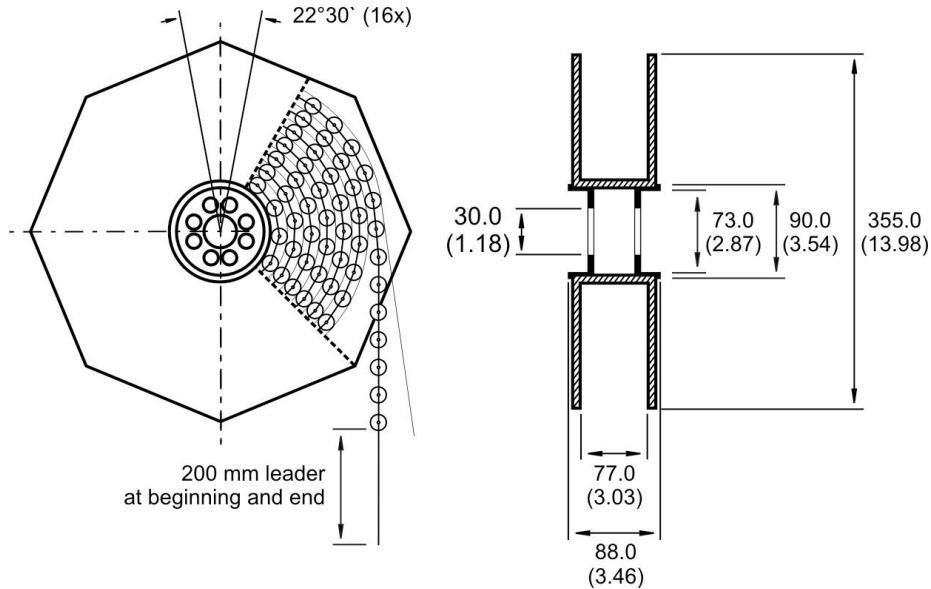

**TESTS AND REQUIREMENTS**

Essentially all tests are carried out in accordance to the schedule of IEC publications 60115 – 1, category 40/200/56 (rated temperature range - 40 to + 200 °C; damp heat, long term, 56 days and along the lines of IEC publications 60068-2); “Recommended basic climatic and mechanical robustness testing procedure for electronic components” and under standard atmosphere conditions according to IEC 60068-1 subclause 5.3, unless otherwise specified.

In some instances deviations from IEC applications were necessary for our method specified.

Table 5. Test and requirements.

IEC 60115-1 CLAUSE	IEC 60068-2 TEST METHOD	TEST	PROCEDURE	REQUIREMENTS
4.8	-	Temperature coefficient	Between - 40 °C and + 200 °C: R < 10 Ω R ≥ 10 Ω	+ 600 ppm/°C - 80 to +140 ppm / °C
4.13	-	Short time overload	Room temperature; dissipation 10 x Pn; 5 s (voltage not more than 1000 V / 25 mm)	$\Delta R/R_{max} \pm 2\% + 0.1 \Omega$

IEC 60115-1 CLAUSE	IEC 60068-2 TEST METHOD	TEST	PROCEDURE	REQUIREMENTS
4.16	21(U)	Robustness of terminations:		
4.16.2	21(Ua)	Tensile all samples	Load 10 N; 10 s	No visual damage $\Delta R/R_{\max} \pm 0.5\% + 0.05 \Omega$
4.16.3	21(Ub)	Bending half number of samples	Load 5 N; 4 x 90°	
4.16.4	21(Uc)	Torsion other half number of samples	2 x 180° in opposite directions	
4.17	20(Ta)	Solderability (after ageing)	16 h 155 °C; leads immersed in flux 600, leads immersed 2 mm for 2 ±0.5 s in a solder bath at 235 ±5 °C	
4.18	20(Tb)	Resistance to soldering heat	Thermal shock: 3 s; 350 ±10 °C; 2.5 mm from body	$\Delta R/R_{\max} \pm 0.5\% + 0.05 \Omega$
4.19	14(Na)	Rapid change of temperature	30 minutes at - 40 °C and 30 minutes at + 200 °C; 5 cycles	No visible damage $\Delta R/R_{\max} \pm 1\% + 0.05 \Omega$
4.22	6(Fc)	Vibration	Frequency 10 to 500 Hz (1 to 7W) and 10 to 55 Hz (10 to 20W), displacement 0.75 mm or acceleration 10 g, three directions; total 6 h (3 x 2 h)	No visible damage $\Delta R/R_{\max} \pm 0.5\% + 0.05 \Omega$
4.23		Climatic sequence		
4.23.2	2(Ba)	Dry heat	16 h; + 200 °C	$\Delta R/R_{\max} \pm 1\% + 0.05 \Omega$
4.23.3	30(Db)	Damp heat (accelerated) 1 <sup>st</sup> cycle	24 h; 25 °C to 55 °C; 90 to 100% R.H.	
4.23.4	1(Aa)	Cold	2 h; - 40 °C	
4.23.6	30(Db)	Damp heat (accelerated) remaining cycles	5 days; 25 °C to 55 °C; 90 to 100% R.H.	
4.24	3(Ca)	Damp heat (steady state)	56 days; 40 °C; 90 to 95% R.H.; loaded with 0.01Pn	No visible damage $\Delta R/R_{\max} \pm 1\% + 0.05 \Omega$
4.25.1	-	Endurance (at 40 °C)	1000 h load with 0.9 Pn; 1.5 h ON and 0.5 h OFF.	No visible damage $\Delta R/R_{\max} \pm 5\% + 0.1 \Omega$
4.29	45 (Xa)	Component solvent resistance	Isopropyl alcohol followed by brushing in accordance with MIL STD 202	No visible damage