

FEATURES

- **±2% Overvoltage Threshold Accuracy**
- **Low Profile (1mm) ThinSOT™ Package**
- Gate Drive for SCR Crowbar or External N-Channel Disconnect MOSFET
- Monitors Two Output Voltages
- Senses Output Voltages from 0.8V to 24V
- Wide Supply Range: 2.7V to 27V
- Multifunction TIMER/RESET Pin

APPLICATIONS

- Telecommunication Systems
- Computer Systems
- Industrial Control Systems
- Notebook Computers

DESCRIPTION

The LTC[®]1696 is a standalone power supply overvoltage monitor and protection device designed to protect a power supply load in the event of an overvoltage fault. It monitors two adjustable output voltages. If an overvoltage condition is detected, the output drives either an external SCR crowbar or turns off external back-to-back N-channel MOSFETs, thereby, disconnecting the input voltage from the power supply.

Pin 6 offers three functions. By connecting a capacitor to this pin, the internal glitch filter time delay can be programmed. Without the capacitor, the default time delay is determined by an internal capacitor. This pin also serves as a reset input to clear the internal latch after an overvoltage fault condition. By pulling it high, the OUT pin is activated if the FB1 and FB2 voltages remain below the trip threshold.

The LTC1696 is available in the low profile (1mm) ThinSOT package.

LT, LTC and LT are registered trademarks of Linear Technology Corporation. ThinSOT is a trademark of Linear Technology Corporation.

TYPICAL APPLICATION

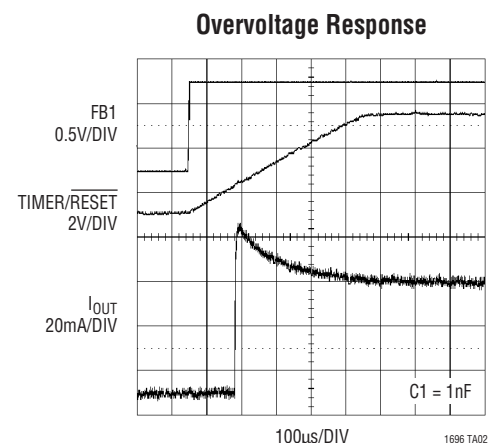
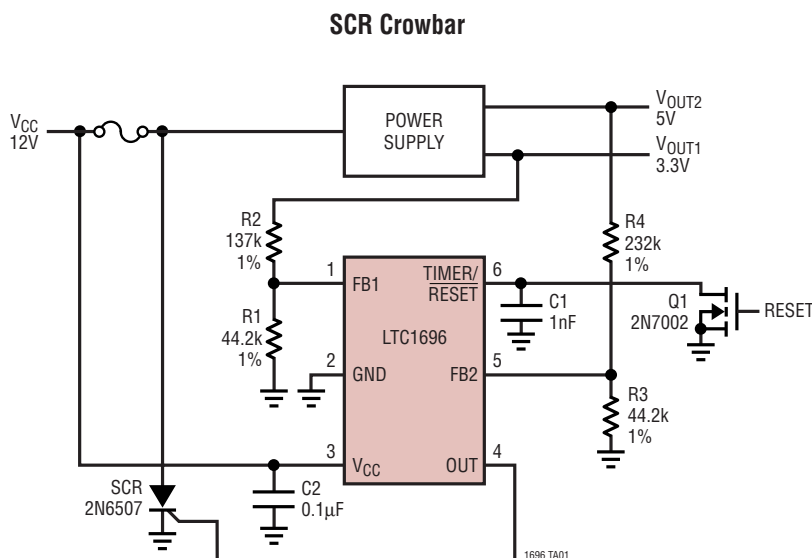

ABSOLUTE MAXIMUM RATINGS

(Note 1)

Supply Voltage (V_{CC})	28V
Input Voltage	
FB1, FB2	-0.3V to 17V
TIMER/RESET	-0.3V to 17V
Operating Temperature Range (Note 2) ..	-40°C to 85°C
Storage Temperature Range	-65°C to 150°C
Lead Temperature (Soldering, 10 sec).....	300°C

PACKAGE/ORDER INFORMATION

	ORDER PART NUMBER
	LTC1696ES6
	S6 PART MARKING
	LTLT

Consult LTC Marketing for parts specified with wider operating temperature ranges.

ELECTRICAL CHARACTERISTICS

The ● denotes the specifications which apply over the full operating temperature range, otherwise specifications are at $T_A = 25^\circ\text{C}$. $2.7\text{V} \leq V_{CC} \leq 27\text{V}$ (Notes 3, 4) unless otherwise noted.

SYMBOL	PARAMETER	CONDITIONS	MIN	TYP	MAX	UNITS
V_{CC}	Supply Voltage Range	Operating Range	● 2.7		27	V
I_{VCC}	Standby Supply Current	FB1, FB2 < V_{FB}	●	170	540	μA
	Active Supply Current	FB1, FB2 > V_{FB} , $C_{OUT} = 1000\text{pF}$	●	1.1	3.5	mA
V_{FB}	FB1, FB2 Feedback Threshold	Voltage Going Positive $T_A \geq 0^\circ\text{C}$	● 0.862	0.880	0.898	V
		$T_A < 0^\circ\text{C}$	● 0.853	0.880	0.907	V
I_{FB}	FB1, FB2 Input Current		● -1	-0.05		μA
V_{FBHST}	FB1, FB2 Feedback Hysteresis	High-to-Low Transition		12		mV
V_{LKO}	V_{CC} Undervoltage Lockout Low-to-High Transition High-to-Low Transition		● 1.75	2.05	2.35	V
			● 1.64	1.94	2.24	V
V_{LKH}	V_{CC} Undervoltage Lockout Hysteresis	FB1, FB2 > V_{FB}		110		mV
V_{RST}	TIMER/RESET Reset Low Threshold	FB1, FB2 > V_{FB}	● 0.78	0.865	0.95	V
V_{TIM}	TIMER/RESET Timer High Threshold	FB1, FB2 > V_{FB}	● 1.11	1.185	1.26	V
V_{TRIG}	TIMER/RESET External Trigger High Threshold	FB1, FB2 < V_{FB}	● 1.35	1.50	1.65	V
I_{TRIG}	TIMER/RESET External Trigger High Current	FB1, FB2 < V_{FB} , TIMER/RESET = V_{TRIG}	●	260	650	μA
I_{TIM}	TIMER/RESET Timer Current	FB1 = ($V_{FB} + 30\text{mV}$), FB2 < V_{FB}	● 4	10	22	μA
		FB1 = ($V_{FB} + 200\text{mV}$), FB2 < V_{FB}	● 5	12	26	μA
		FB2 = ($V_{FB} + 30\text{mV}$), FB1 < V_{FB}	● 4	10	22	μA
		FB2 = ($V_{FB} + 200\text{mV}$), FB1 < V_{FB}	● 5	12	26	μA
		FB1, FB2 = ($V_{FB} + 200\text{mV}$)	● 8	18	40	μA
V_{OUTH}	OUT High Voltage	$12\text{V} \leq V_{CC} \leq 27\text{V}$, FB1, FB2 > V_{FB} , $C_{OUT} = 1000\text{pF}$	● 4.8	6.3	8.0	V
		$V_{CC} = 3.3\text{V}$, FB1, FB2 > V_{FB} , $C_{OUT} = 1000\text{pF}$	● 2.7	3.2	3.3	V
V_{OUTL}	OUT Low Voltage	FB1, FB2 < V_{FB} , $I_{SINK} = 1\text{mA}$, $V_{CC} = 3.3\text{V}$	●		0.45	V
t_{OVPD1}	OUT Propagation Delay for FB1	FB1 > V_{FB} , FB2 < V_{FB} , TIMER/RESET = Open, $C_{OUT} = 1000\text{pF}$	●	7	28	μs
t_{OVPD2}	OUT Propagation Delay for FB2	FB2 > V_{FB} , FB1 < V_{FB} , TIMER/RESET = Open, $C_{OUT} = 1000\text{pF}$	●	7	28	μs

ELECTRICAL CHARACTERISTICS

The ● denotes the specifications which apply over the full operating temperature range, otherwise specifications are at $T_A = 25^\circ\text{C}$. $2.7\text{V} \leq V_{CC} \leq 27\text{V}$ (Notes 3, 4) unless otherwise noted.

SYMBOL	PARAMETER	CONDITIONS	MIN	TYP	MAX	UNITS	
$t_{OVPD1,2}$	OUT Propagation Delay for FB1, FB2	FB1, FB2 > V_{FB} , TIMER/RESET = Open $C_{OUT} = 1000\text{pF}$	●	6	24	μs	
t_r	OUT Rise Time	FB1, FB2 > V_{FB} , $C_{OUT} = 1000\text{pF}$	●	0.4	3	μs	
I_{OUTSC}	OUT Short-Circuit Current	$12\text{V} \leq V_{CC} \leq 27\text{V}$, FB1, FB2 > V_{FB} , V_{OUT} Shorted to GND	●	35	80	160	mA
		$V_{CC} = 2.7\text{V}$, FB1, FB2 > V_{FB} , V_{OUT} Shorted to GND	●	2	9	18	mA

Note 1: Absolute Maximum Ratings are those values beyond which the life of the device may be impaired.

Note 2: The LTC1696E is guaranteed to meet performance specifications from 0°C to 70°C . Specifications over the -40°C to 85°C operating temperature range are assured by design, characterization and correlation with statistical process controls.

Note 3: All currents into device pins are positive; all currents out of device pins are negative. All voltages are referenced to device ground unless otherwise specified.

Note 4: All typical numbers are given for $V_{CC} = 12\text{V}$ and $T_A = 25^\circ\text{C}$.

TYPICAL PERFORMANCE CHARACTERISTICS

Standby Supply Current vs Supply Voltage

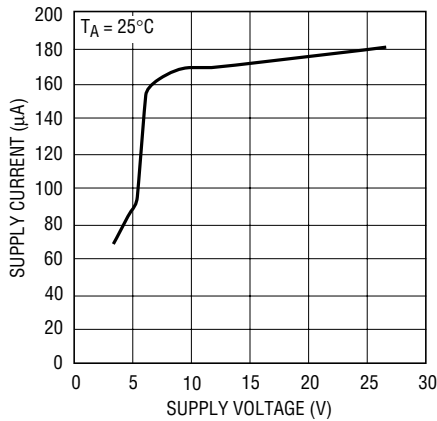

1696 G01

Standby Supply Current vs Temperature

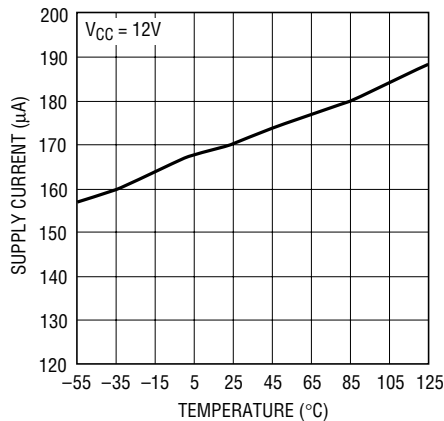

1696 G02

Active Supply Current vs Supply Voltage

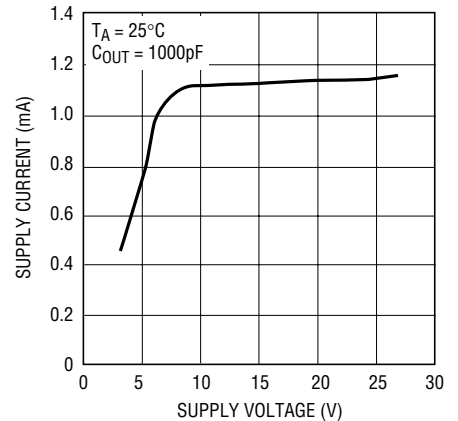

1696 G03

Active Supply Current vs Temperature

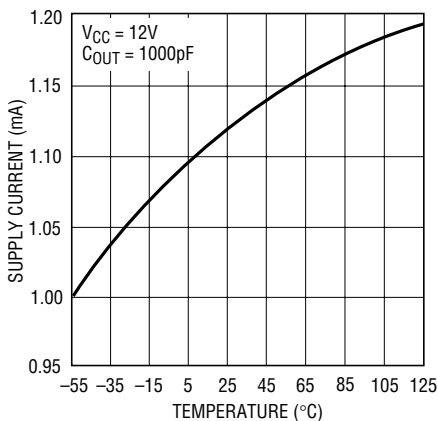

1696 G04

FB1, FB2 Feedback Threshold Voltage vs Supply Voltage

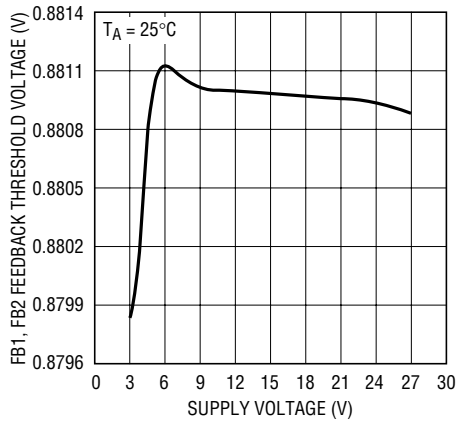

1696 G05

FB1, FB2 Feedback Threshold Voltage vs Temperature

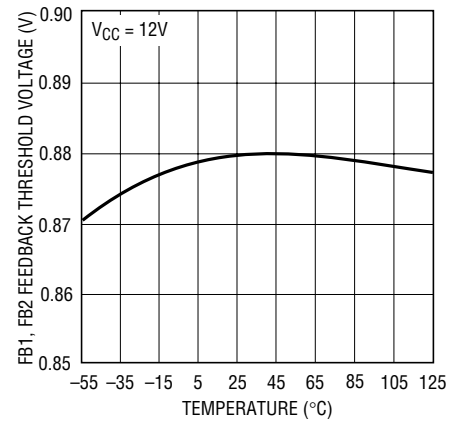

1696 G06

TIMER Threshold Voltage vs Supply Voltage

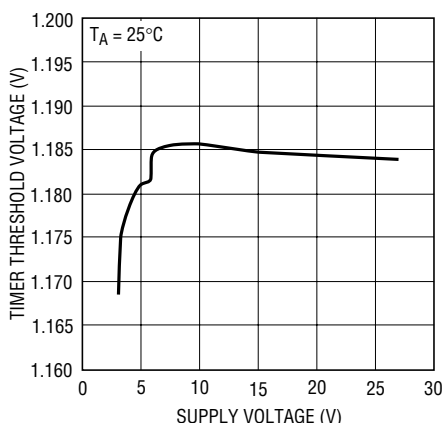

1696 G07

TIMER Threshold Voltage vs Temperature

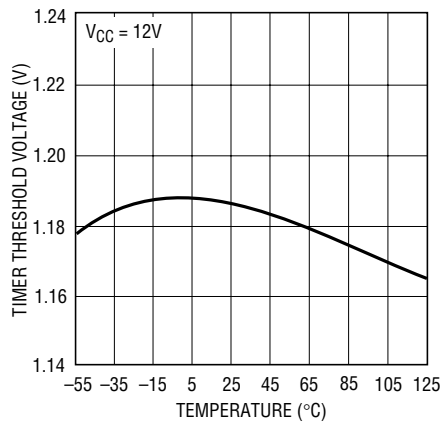

1696 G08

TIMER Current vs Supply Voltage

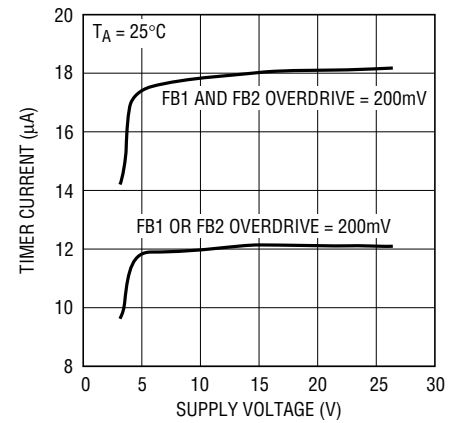

1696 G09

TYPICAL PERFORMANCE CHARACTERISTICS

TIMER Current vs Temperature

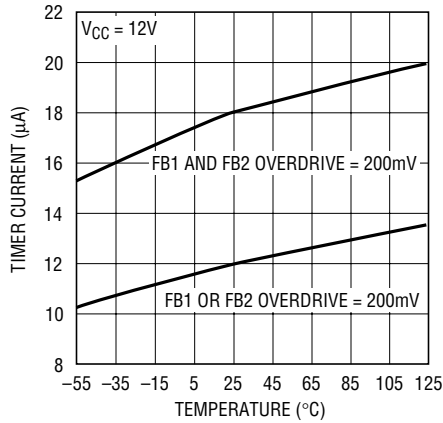

1696 G10

TIMER Current vs Feedback Overdrive

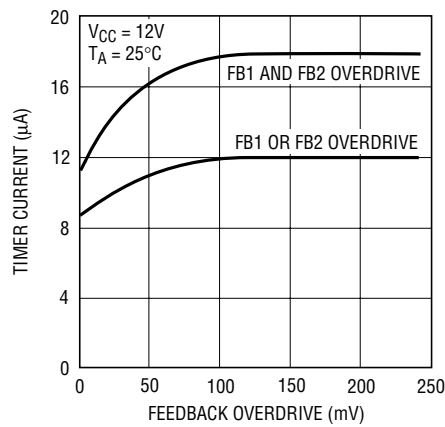

1696 G11

TIMER Current vs Feedback Overdrive

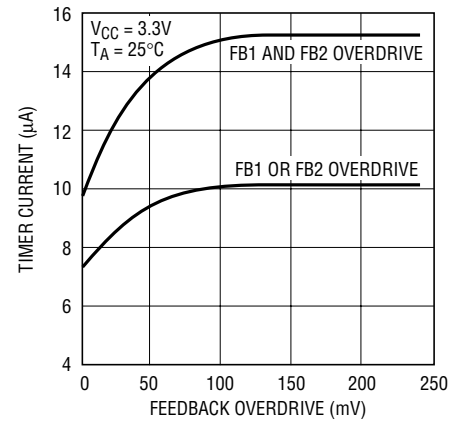

1696 G12

Glitch Filter Timer vs Feedback Overdrive

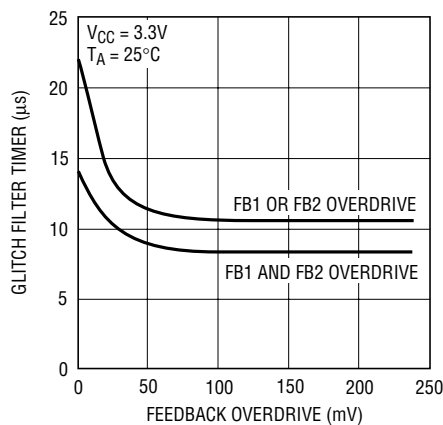

1696 G13

Glitch Filter Timer vs Feedback Overdrive

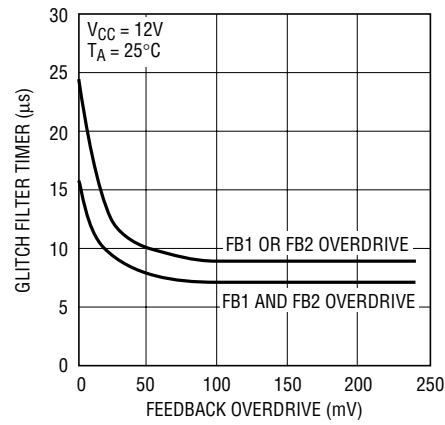

1696 G14

External Trigger Threshold Voltage vs Supply Voltage

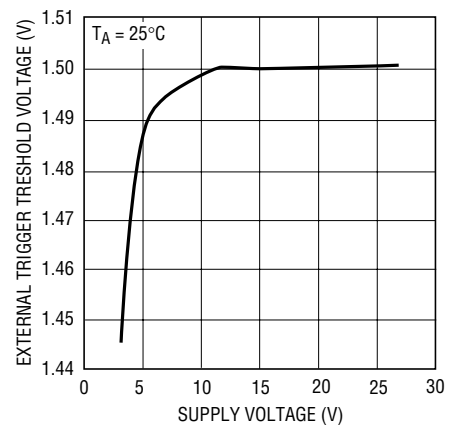

1696 G15

External Trigger Threshold Voltage vs Temperature

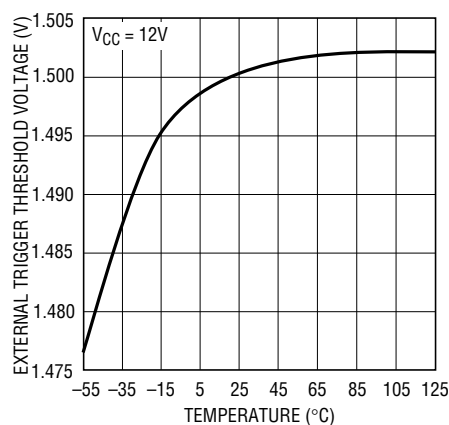

1696 G16

RESET Threshold Voltage vs Supply Voltage

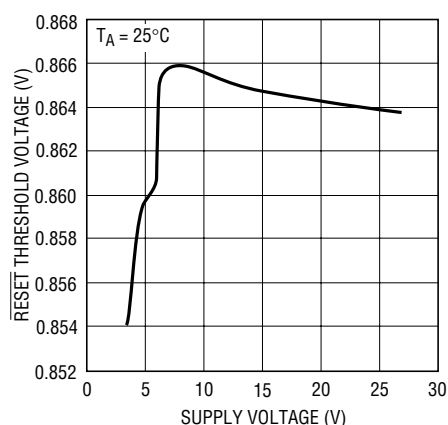

1696 G17

RESET Threshold Voltage vs Temperature

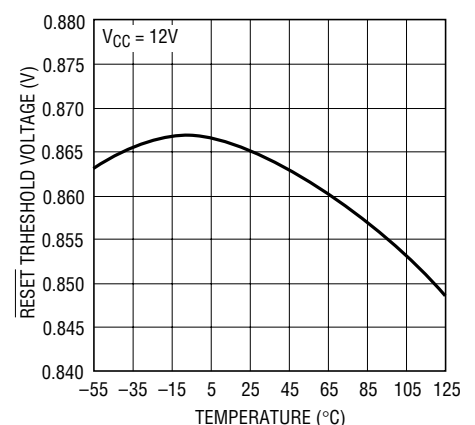

1696 G18

TYPICAL PERFORMANCE CHARACTERISTICS

OUT Pin Active Output Voltage vs Supply Voltage

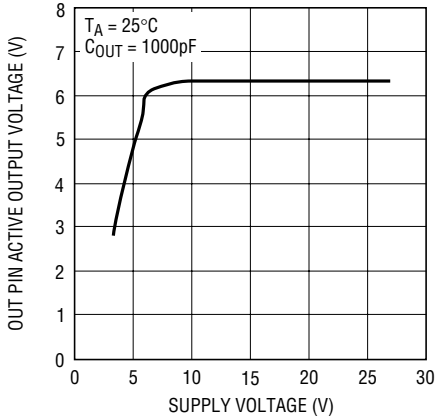

1696 G19

OUT Pin Active Output Voltage vs Temperature

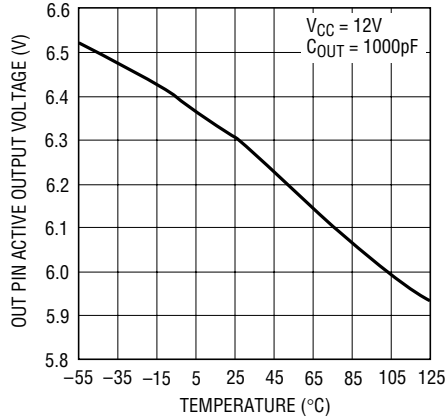

1696 G20

OUT Pin Short-Circuit Current vs Supply Voltage

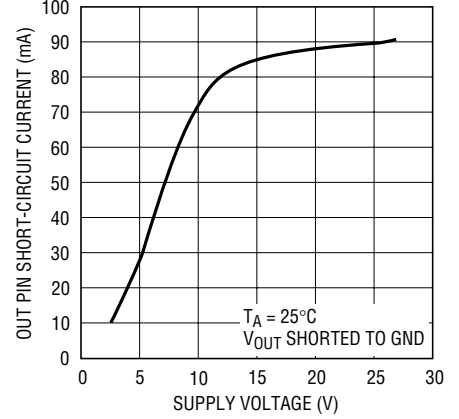

1696 G21

OUT Pin Short-Circuit Current vs Temperature

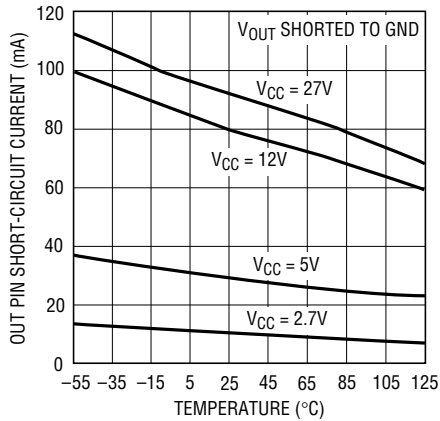

1696 G22

OUT Pin Active Output Current vs Output Voltage

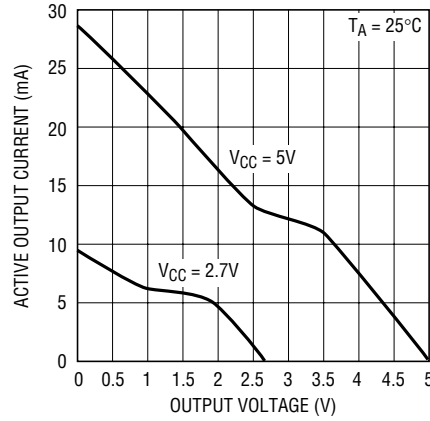

1696 G23

OUT Pin Active Output Current vs Output Voltage

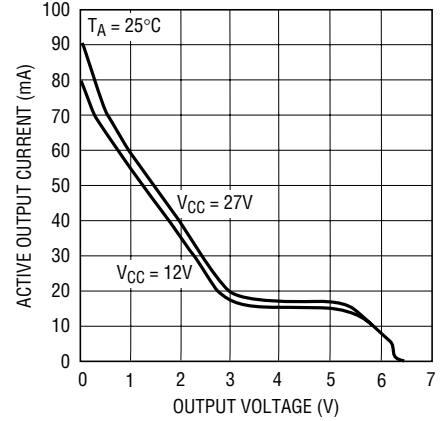

1696 G24

PIN FUNCTIONS

FB1 (Pin 1): First Feedback Input. FB1 monitors and senses the first supply output voltage through an external resistor divider. This voltage is then compared with an internal reference voltage of 0.88V, which sets the threshold for an overvoltage fault detection. If the sense voltage exceeds the threshold level, the output response time at the OUT pin is dependent on the feedback overdrive above the threshold level. The higher the feedback overdrive, the faster will be the response time.

GND (Pin 2): Power Ground. Return path for all device currents.

V_{CC} (Pin 3): Power Supply. The pin is connected separately from the power supply output that the chip is monitoring. Its input range is from 2.7V to 27V. The quiescent current is typically 100 μ A in standby mode when the device is operating at 5V. The quiescent current increases to 170 μ A when operating at 12V.

OUT (Pin 4): Output Current Limit Driver. Capable of delivering continuous current, typically 80mA, at high supplies. The output current decreases with lower supply voltage. This pin directly drives the SCR crowbar at high supply voltage. It can also provide gate drive for an N-channel MOSFET or the base of an NPN transistor, which drives the gate of an external SCR at low supply voltage. It is normally in the inactive low state in the standby mode. In the event of an overvoltage fault condition, the OUT pin is latched into the active high state. The latched active high state is reset by pulling the TIMER/RESET pin low through an N-channel MOSFET switch or if the supply voltage at the V_{CC} pin goes below the undervoltage lockout threshold voltage of 1.94V.

FB2 (Pin 5): Second Feedback Input. FB2 monitors and senses the second supply output voltage through an external resistor divider. This voltage is then compared with an internal reference voltage of 0.88V, which sets the threshold for an overvoltage fault detection. If the sense voltage exceeds the threshold level, the output response time at the OUT pin is dependent on the feedback overdrive above the threshold level. The higher the feedback overdrive, the faster will be the response time.

TIMER/RESET (Pin 6): Glitch Filter Timer Capacitor, Reset and External Trigger Input. The external capacitor connected to this pin programs the internal glitch filter time delay. The internal current source used to charge the timer capacitor is typically 10 μ A with feedback overdrive of less than 20mV above the feedback trip threshold from one feedback input. The current source increases to 12 μ A when the feedback overdrive increases to more than 100mV. It further increases to 18 μ A if larger overdrive occurs from both feedback inputs. The default glitch filter time delay without an external timer capacitor is fixed by an internal capacitor of 5pF with the internal reference voltage of 1.185V. The delay reduces with increases in first and second feedback input overdrive. This pin also serves as a reset input to clear the internal latch during an overvoltage fault condition. If pulled low, it resets the active high state of the internal latch. The reset signal to this pin should be an open drain type. This pin can also be driven high externally to activate the OUT pin active high if the FB1 and FB2 voltages remain below the feedback trip threshold.

APPLICATIONS INFORMATION

Back-to-Back N-Channel MOSFET

A power management circuit that uses the LTC1696 to control external back-to-back N-channel MOSFET at low supply voltage is shown in Figure 3. In standby mode, the drain of the external N-channel MOSFET, Q1, is pulled high

by the power management controller when the LTC1696 OUT pin is in the low state. The LTC1696 drives the gate of Q1 high during an overvoltage fault condition. This pulls the drain of Q1 low and turns off the back-to-back N-channel MOSFETs.

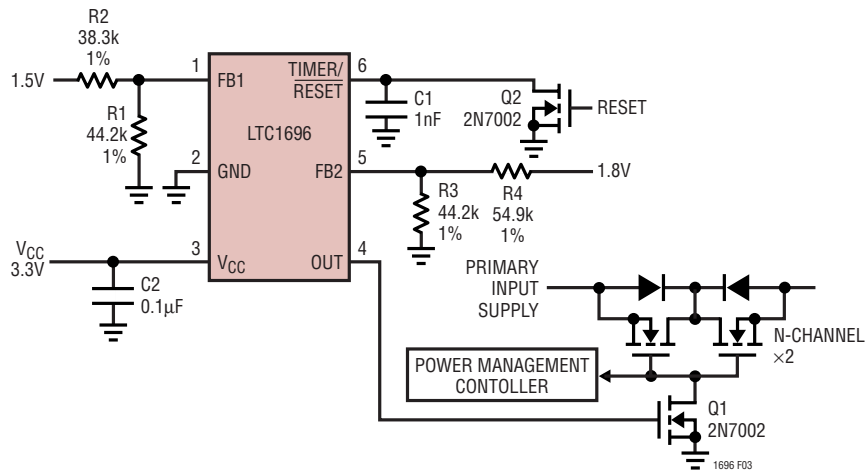
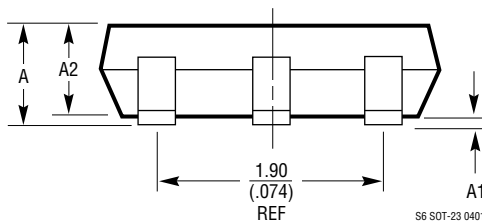
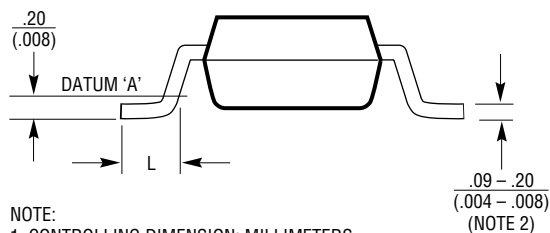
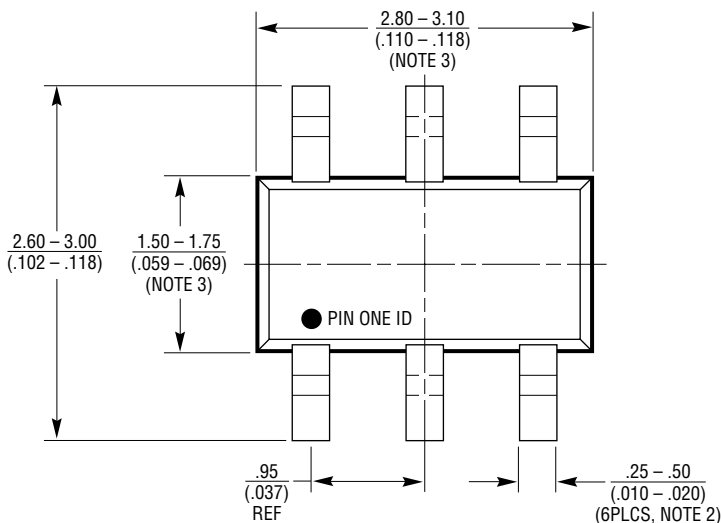

Figure 3. Back-to-Back N-Channel MOSFETs for Low Supply Application

PACKAGE DESCRIPTION

S6 Package
6-Lead Plastic SOT-23
 (LTC DWG # 05-08-1634)
 (LTC DWG # 05-08-1636)

	SOT-23 (Original)	SOT-23 (ThinSOT)
A	.90 - 1.45 (.035 - .057)	1.00 MAX (.039 MAX)
A1	.00 - 0.15 (.00 - .006)	.01 - .10 (.0004 - .004)
A2	.90 - 1.30 (.035 - .051)	.80 - .90 (.031 - .035)
L	.35 - .55 (.014 - .021)	.30 - .50 REF (.012 - .019 REF)



- NOTE:
1. CONTROLLING DIMENSION: MILLIMETERS
 2. DIMENSIONS ARE IN $\frac{\text{MILLIMETERS}}{\text{INCHES}}$
 3. DRAWING NOT TO SCALE
 4. DIMENSIONS ARE INCLUSIVE OF PLATING
 5. DIMENSIONS ARE EXCLUSIVE OF MOLD FLASH AND METAL BURR
 6. MOLD FLASH SHALL NOT EXCEED .254mm
 7. PACKAGE EIAJ REFERENCE IS:
 SC-74A (EIAJ) FOR ORIGINAL
 JEDEC MO-193 FOR THIN

APPLICATIONS INFORMATION

External Triggering

The LTC1696 has a feature which allows the output to be latched into an active high state by pulling the TIMER/RESET pin high. Figure 4 shows a circuit that uses the external triggering function of the LTC1696.

FB1 and FB2 pins are below the trip threshold of the internal comparator. The output is then reset by pulling the TIMER/RESET pin low. Figure 4 shows a circuit that uses the external triggering function of the LTC1696.

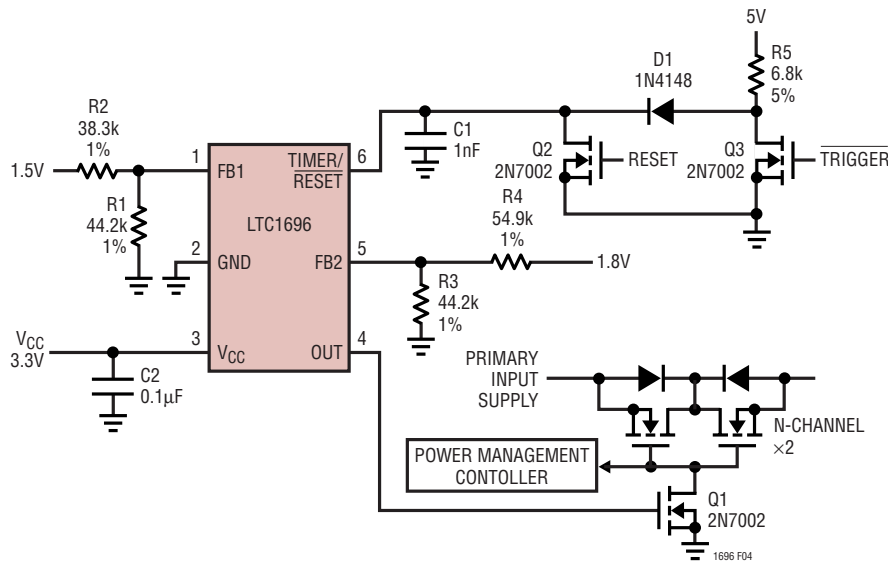

Figure 4. External Triggering

RELATED PARTS

PART NUMBER	DESCRIPTION	COMMENTS
LTC1473	Dual PowerPath™ Switch Driver	For Systems with Multiple DC Sources, V_{IN} Up to 30V, Inrush and Short-Circuit Protection
LTC1628	High Efficiency, 2-Phase Synchronous Step-Down Switching Regulator	Out-of-Phase Controllers, $3.5V \leq V_{IN} \leq 36V$, $\pm 1\%$ Output Voltage Accuracy
LT1681	Dual Transistor Synchronous Forward Controller	Operation Up to 72V Maximum
LTC1698	Secondary Synchronous Rectifier Controller	Optocoupler Feedback with Pulse Transformer Synchronization
LTC1703	Dual 550k Synchronous 2-Phase Switching Regulator Controller with VID	Two Independent PWM Controllers, Wide Load Current Range, 1.5% Output Accuracy
LTC1735	Synchronous Step-Down Switching Regulator	Current Mode, $3.5V \leq V_{IN} \leq 36V$, $0.5V \leq V_{OUT} \leq 5V$
LTC1922-1	Synchronous Phase Modulated Full-Bridge Controller	Output Power Levels from 50W to Several kW, Adaptive DirectSense™ Zero Voltage Switching
LTC1960	Dual Battery Charger/Selector with SPI Interface	Extends Run Time, Reduces Charging Time, Crisis Management Prevents Power Interruption, 36-Pin SSOP

PowerPath and DirectSense are trademarks of Linear Technology Corporation.