

TELUX™ LED

Description

The TELUX™ series is a clear, non diffused LED for high end applications where supreme luminous flux is required.

It is designed in an industry standard 7.62 mm square package utilizing highly developed InGaN technology. The supreme heat dissipation of TELUX™ allows applications at high ambient temperatures.

All packing units are binned for luminous flux and color to achieve best homogenous light appearance in application.

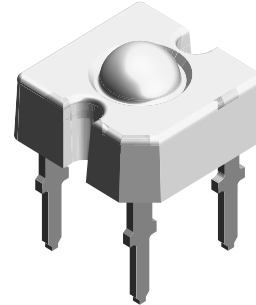

16 012

Features

- Utilizing InGaN technology
- High luminous flux
- Supreme heat dissipation: R_{thJP} is 90 K/W
- High operating temperature: $T_j + 100\text{ °C}$
- Packed in tubes for automatic insertion
- Luminous flux and color categorized for each tube
- Small mechanical tolerances allow precise usage of external reflectors or lightguides
- ESD-withstand voltage:
> 1 kV acc. to MIL STD 883 D, Method 3015.7
- Lead (Pb)-free device
- RoHS compliant



Applications

- Exterior lighting
- Dashboard illumination
- Tail-, Stop - and Turn Signals of motor vehicles
- Replaces incandescent lamps

Parts Table

Part	Color, Luminous Intensity	Angle of Half Intensity ($\pm \phi$)	Technology
VLWW9900	White, $\phi_v > 1500$ mlm	45°	InGaN / TAG on SiC

Absolute Maximum Ratings

$T_{amb} = 25\text{ °C}$, unless otherwise specified

VLWW9900

Parameter	Test condition	Symbol	Value	Unit
Reverse voltage	$I_R = 10\ \mu\text{A}$	V_R	5	V
DC Forward current	$T_{amb} \leq 50\text{ °C}$	I_F	50	mA
Surge forward current	$t_p \leq 10\ \mu\text{s}$	I_{FSM}	0.1	A
Power dissipation		P_V	255	mW
Junction temperature		T_j	100	°C
Operating temperature range		T_{amb}	- 40 to + 100	°C
Storage temperature range		T_{stg}	- 40 to + 100	°C
Soldering temperature	$t \leq 5\text{ s}$, 1.5 mm from body preheat temperature 100 °C/ 30 sec.	T_{sd}	260	°C
Thermal resistance junction/ambient	with cathode heatsink of 70 mm ²	R_{thJA}	200	K/W
Thermal resistance junction/pin		R_{thJP}	90	K/W

Optical and Electrical Characteristics

T_{amb} = 25 °C, unless otherwise specified

White

VLWW9900

Parameter	Test condition	Symbol	Part	Min	Typ.	Max	Unit
Total flux	I _F = 50 mA, R _{thJA} = 200 °K/W	Φ _V	VLWW9900	1500	2200		mlm
Luminous intensity/Total flux	I _F = 50 mA, R _{thJA} = 200 °K/W	I _V /Φ _V			0.8		mcd/mlm
Color temperature	I _F = 50 mA, R _{thJA} = 200 °K/W	T _K			5500		K
Angle of half intensity	I _F = 50 mA, R _{thJA} = 200 °K/W	φ			± 45		deg
Total included angle	90 % of Total Flux Captured	φ			75		deg
Forward voltage	I _F = 50 mA, R _{thJA} = 200 °K/W	V _F			4.3	5.2	V
Reverse voltage	I _R = 10 μA	V _R		5	10		V
Junction capacitance	V _R = 0, f = 1 MHz	C _j			50		pF

Chromaticity Coordinate Classification

Group	X		Y	
	min	max	min	max
VLWW9900				
3a	0.2900	0.3025	Y = 1.4x - 0.121	Y = 1.4x - 0.071
3b	0.3025	0.3150	Y = 1.4x - 0.121	Y = 1.4x - 0.071
3c	0.2900	0.3025	Y = 1.4x - 0.171	Y = 1.4x - 0.121
3d	0.3025	0.3150	Y = 1.4x - 0.171	Y = 1.4x - 0.121
4a	0.3150	0.3275	Y = 1.4x - 0.121	Y = 1.4x - 0.071
4b	0.3275	0.3400	Y = 1.4x - 0.121	Y = 1.4x - 0.071
4c	0.3150	0.3275	Y = 1.4x - 0.171	Y = 1.4x - 0.121
4d	0.3275	0.3400	Y = 1.4x - 0.171	Y = 1.4x - 0.121
5a	0.3400	0.3525	Y = 1.4x - 0.121	Y = 1.4x - 0.071
5b	0.3525	0.3650	Y = 1.4x - 0.121	Y = 1.4x - 0.071
5c	0.3400	0.3525	Y = 1.4x - 0.171	Y = 1.4x - 0.121
5d	0.3525	0.3650	Y = 1.4x - 0.171	Y = 1.4x - 0.121

tolerance ± 0.05

Luminous Flux Classification

Group	Luminous Intensity (mlm)	
	min	max
C	1500	2400
D	2000	3000
E	2500	3600
F	3000	4200

Typical Characteristics (T_{amb} = 25 °C unless otherwise specified)

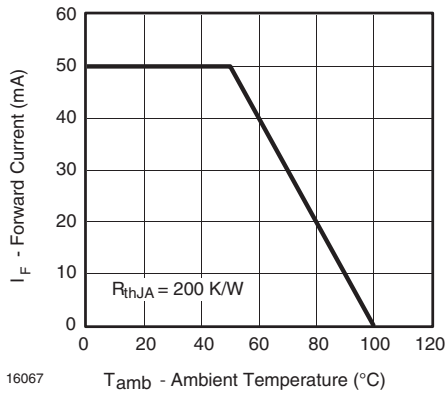

Figure 1. Forward Current vs. Ambient Temperature for InGaN

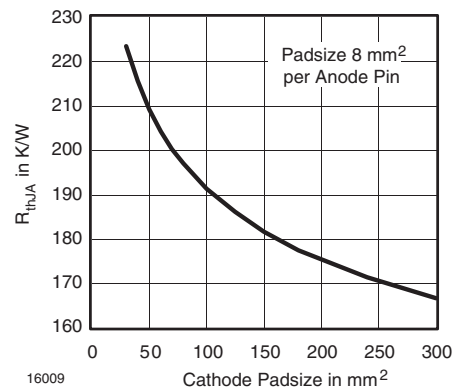

Figure 4. Thermal Resistance Junction Ambient vs. Cathode Padsize

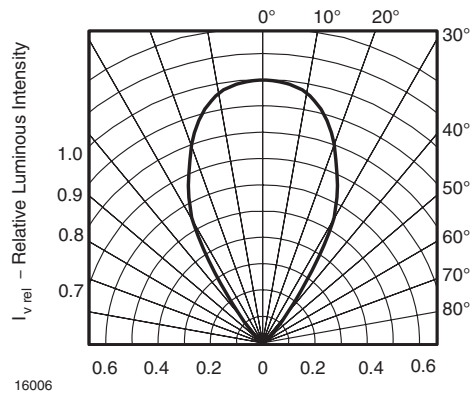

Figure 2. Rel. Luminous Intensity vs. Angular Displacement for 60° emission angle

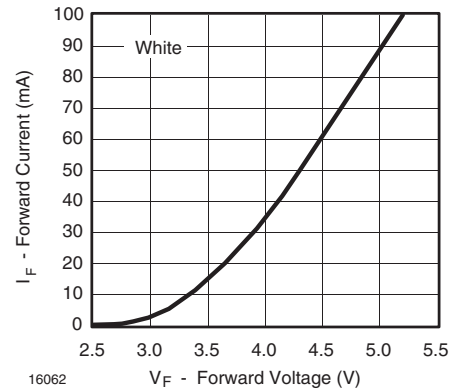

Figure 5. Forward Current vs. Forward Voltage

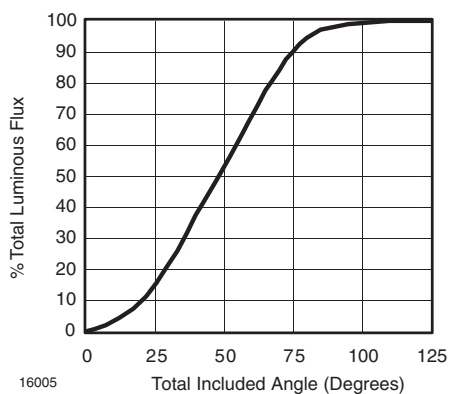

Figure 3. Percentage Total Luminous Flux vs. Total Included Angle for 60° emission angle

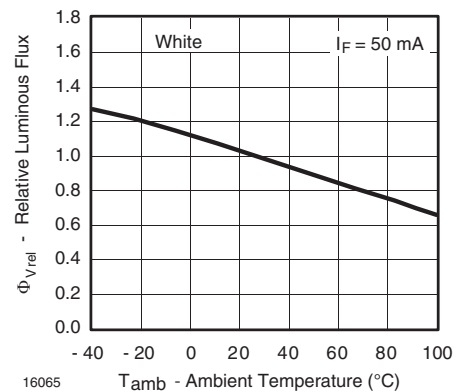

Figure 6. Rel. Luminous Flux vs. Ambient Temperature

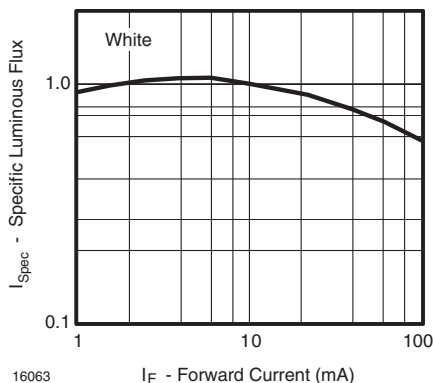

Figure 7. Specific Luminous Flux vs. Forward Current

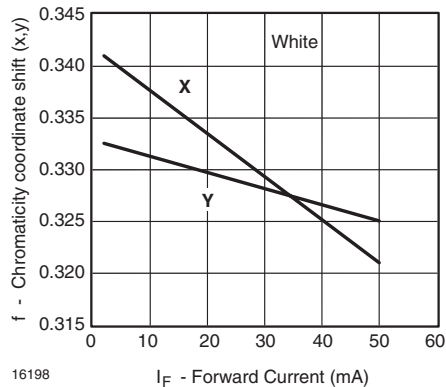

Figure 10. Chromaticity Coordinate Shift vs. Forward Current

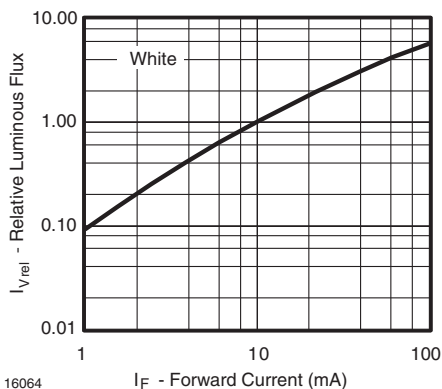

Figure 8. Relative Luminous Flux vs. Forward Current

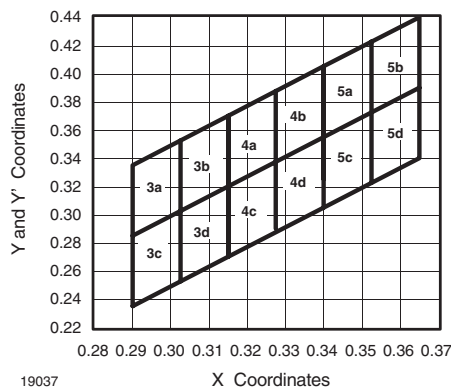

Figure 11. Coordinates of Colorgroups

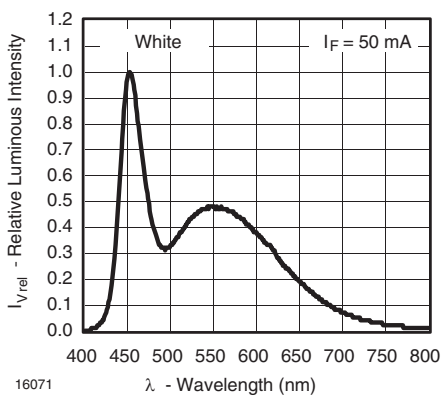
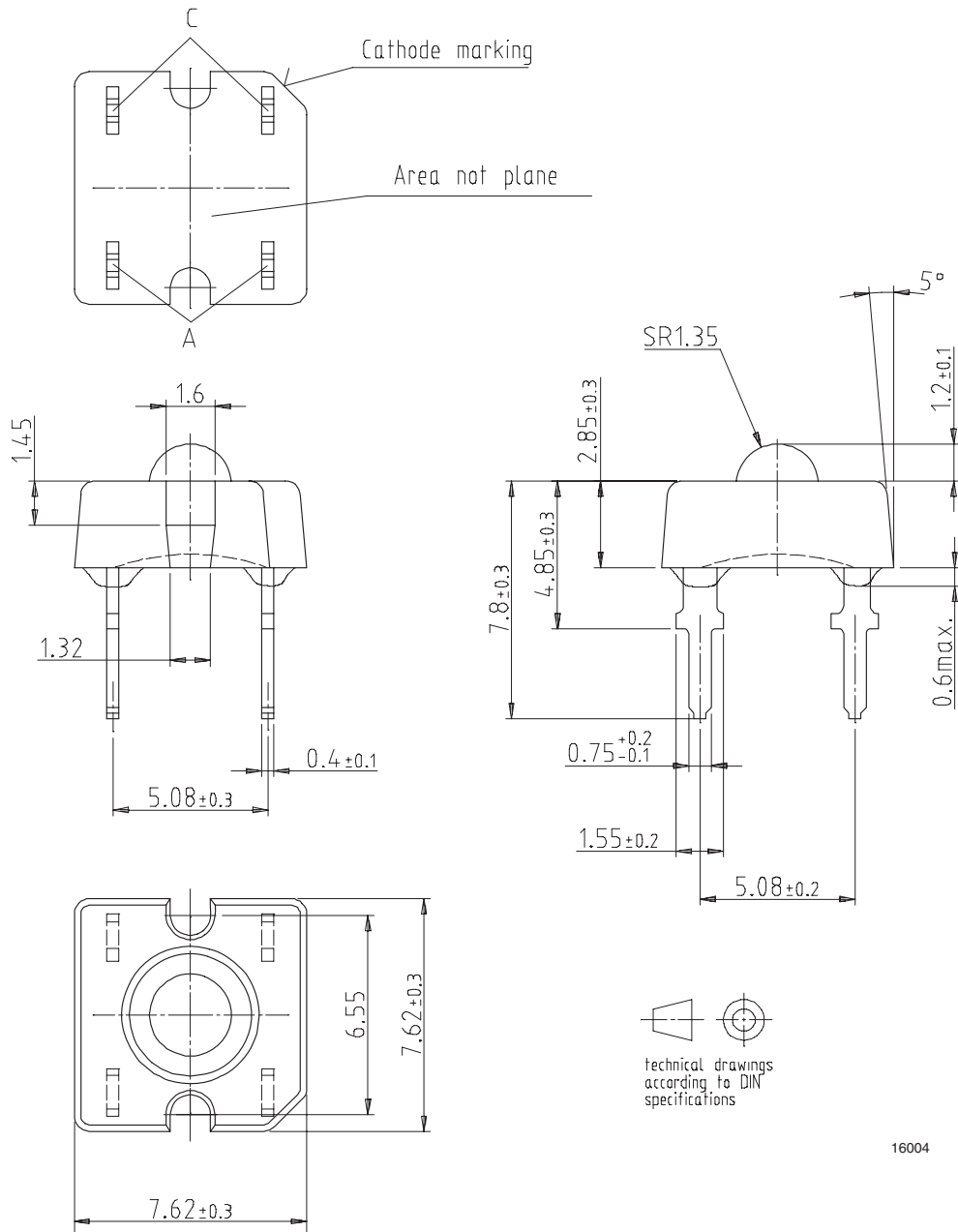

Figure 9. Relative Intensity vs. Wavelength

Package Dimensions in mm



16004

Barcode-Product-Label

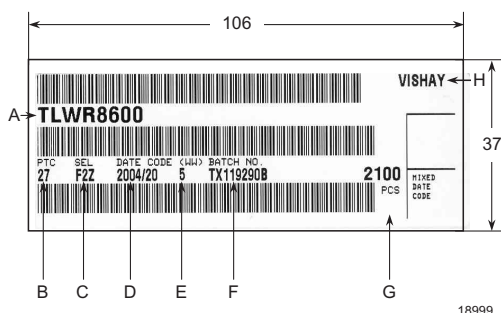

A) Type of component

B) Manufacturing plant

C) SEL - Selection Code (Bin)

Digit 1 - code for Luminous Flux group

Digit 2 - code for Dominant Wavelength group

Digit 3 - code for Forward Voltage group

D) Date Code year/week

E) Day Code (e. g. 5: Friday)

F) Batch No.

G) Total quantity

H) Company code



Ozone Depleting Substances Policy Statement

It is the policy of Vishay Semiconductor GmbH to

1. Meet all present and future national and international statutory requirements.
2. Regularly and continuously improve the performance of our products, processes, distribution and operating systems with respect to their impact on the health and safety of our employees and the public, as well as their impact on the environment.

It is particular concern to control or eliminate releases of those substances into the atmosphere which are known as ozone depleting substances (ODSs).

The Montreal Protocol (1987) and its London Amendments (1990) intend to severely restrict the use of ODSs and forbid their use within the next ten years. Various national and international initiatives are pressing for an earlier ban on these substances.

Vishay Semiconductor GmbH has been able to use its policy of continuous improvements to eliminate the use of ODSs listed in the following documents.

1. Annex A, B and list of transitional substances of the Montreal Protocol and the London Amendments respectively
2. Class I and II ozone depleting substances in the Clean Air Act Amendments of 1990 by the Environmental Protection Agency (EPA) in the USA
3. Council Decision 88/540/EEC and 91/690/EEC Annex A, B and C (transitional substances) respectively.

Vishay Semiconductor GmbH can certify that our semiconductors are not manufactured with ozone depleting substances and do not contain such substances.

We reserve the right to make changes to improve technical design and may do so without further notice.

Parameters can vary in different applications. All operating parameters must be validated for each customer application by the customer. Should the buyer use Vishay Semiconductors products for any unintended or unauthorized application, the buyer shall indemnify Vishay Semiconductors against all claims, costs, damages, and expenses, arising out of, directly or indirectly, any claim of personal damage, injury or death associated with such unintended or unauthorized use.

Vishay Semiconductor GmbH, P.O.B. 3535, D-74025 Heilbronn, Germany