

Voltage Regulators with Stand-by Function - Input Voltage: 28V

*XE6216 series are under development

GENERAL DESCRIPTION

XC6216/XE6216 series are positive voltage regulator ICs with 28V of operation voltage. The series consists of a voltage reference, an error amplifier, a current limiter, a thermal shutdown circuit and a phase compensation circuit plus a driver transistor.

The output voltage is selectable in 100mV increments within the range of 2.0V to 12V using laser trimming technologies. With external resistors, the output voltage range can be expanded from 2.0V to 23V. The series' output stabilization capacitor (CL) is also compatible with low ESR ceramic capacitors.

The over current protection circuit and the thermal shutdown circuit are built-in. These two protection circuits will operate when the output current reaches current limit level or the junction temperature reaches temperature limit level.

The CE function enables the output to be turned off and the IC becomes a stand-by mode resulting in greatly reduced power consumption.

APPLICATIONS

Car audio, Car navigation systems

Note book computers, PDAs

Home appliances

Audio visual equipment

(Cameras, VCRs, etc.)

Cordless phones,

Wireless communication equipment

FEATURES

Max Output Current	: More than 150mA (200mA limit) ($V_{IN}=V_{OUT(T)}+3.0V$)
Dropout Voltage	: 300mV@ $I_{OUT}=20mA$
Input Voltage Range	: 2.0V~28.0V
Output Voltage Setting Range	: 2.0V~12.0V (100mV increments) 2.0V~23V with external resistors
High Accuracy	: Setting Voltage Accuracy $\pm 2\%$ (Setting Voltage Accuracy $\pm 1\%$ Possible)
Low Power Consumption	: 5 μA
Stand-by Current	: Less than 0.1 μA
High Ripple Rejection	: 30dB@1kHz
Operating Temperature	: -40 ~+85
Low ESR Capacitor	: Ceramic Capacitor Compatible
Current Limit Circuit Built-In	
Thermal Shutdown Circuit Built-In	
Small Packages	: SOT-25, SOT-89, SOT-89-5, USP-6C, SOT-223, TO-252

TYPICAL APPLICATION CIRCUIT

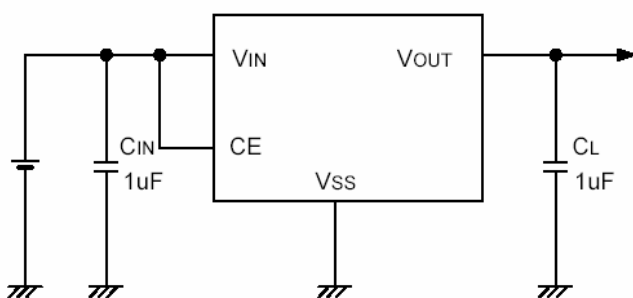

Fixed Output Voltage
XC6216B/XE6216B Series

TYPICAL PERFORMANCE CHARACTERISTICS

Output Voltage vs. Input Voltage

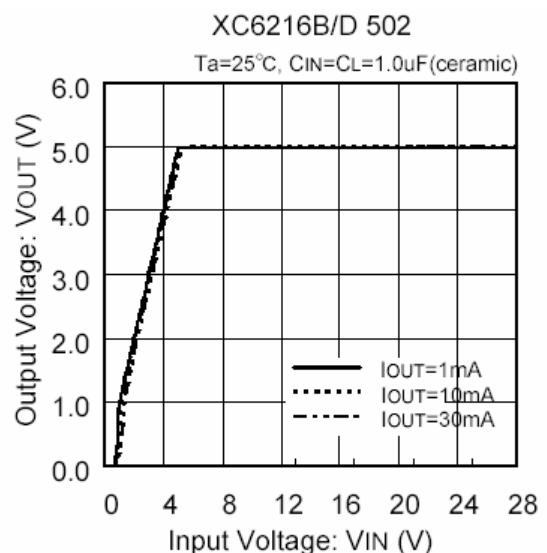

PIN CONFIGURATION

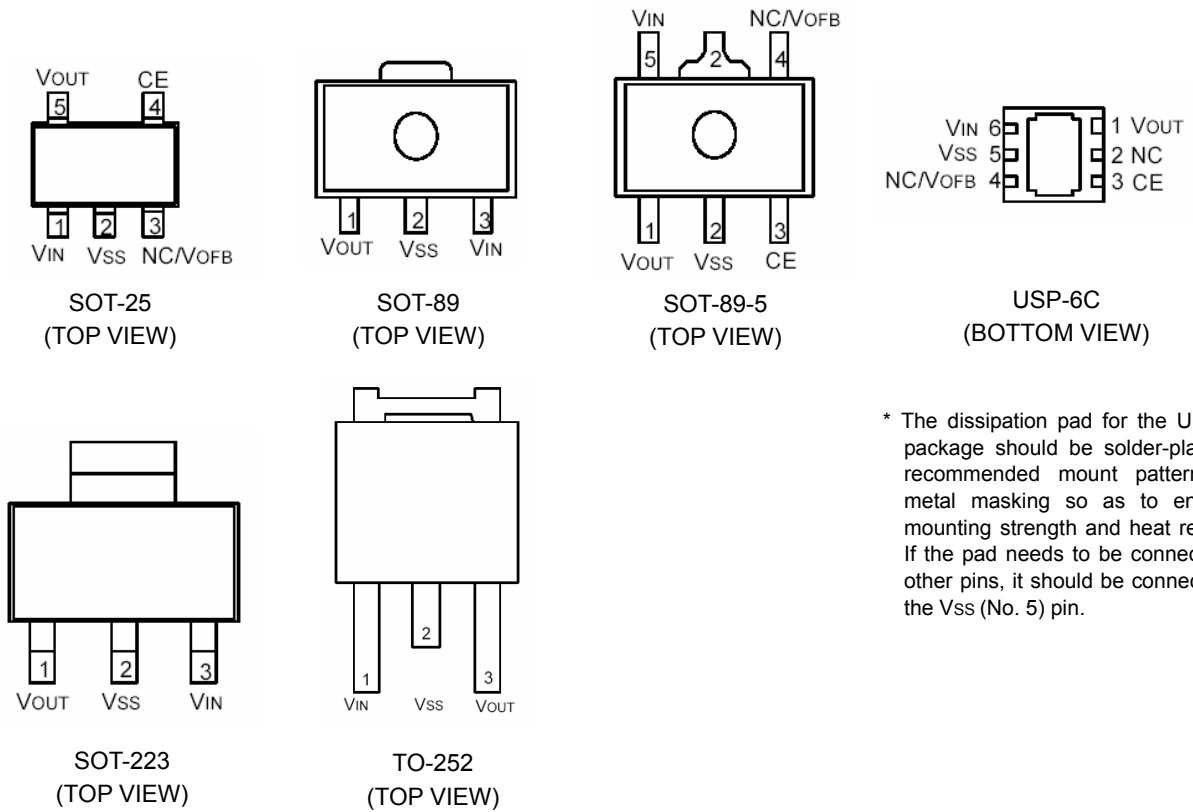

* The dissipation pad for the USP-6C package should be solder-plated in recommended mount pattern and metal masking so as to enhance mounting strength and heat release. If the pad needs to be connected to other pins, it should be connected to the Vss (No. 5) pin.

PIN ASSIGNMENT

XC6216B/XE6216B Series

PIN NUMBER			PIN NAME	FUNCTIONS
SOT-25	SOT-89-5	USP-6C		
1	5	6	VIN	Power Input
2	2	5	VSS	Ground
3	4	4	NC	No connection
4	3	3	CE	ON/OFF Control
5	1	1	VOUT	Output
-	-	2	NC	No connection

XC6216C/XE6216C Series

PIN NUMBER			PIN NAME	FUNCTIONS
SOT-25	SOT-89-5	USP-6C		
1	5	6	VIN	Power Input
2	2	5	VSS	Ground
3	4	4	VOFB	Output Voltage Adjustment
4	3	3	CE	ON/OFF Control
5	1	1	VOUT	Output
-	-	2	NC	No connection

XC6216D/XE6216D Series

PIN NUMBER			PIN NAME	FUNCTIONS
SOT-89	SOT-223	TO-252		
3	3	1	VIN	Power Input
2	2	2	VSS	Ground
1	1	3	VOUT	Output

PRODUCT CLASSIFICATION

Ordering Information

XC6216

DESIGNATOR	DESCRIPTION	SYMBOL	DESCRIPTION
	Type and Options of Regulators	B	: Fixed output voltage, High Active
		C	: Output voltage externally set, High Active
		D	: Fixed output voltage, No CE function
	Output Voltage	20 ~ 99	: For the voltage within 2.0V ~9.9V; e.g. 2.5V 25 5.0V 50
		A, B, C	: For the voltage above 10.0V; e.g. 10.6V A6 11.2V B2 12.0V C0
		20	: For C type (output voltage externally set), V _{OFB} =2.0V only
	Output Voltage Accuracy	2	: Output voltage 100mV increments, within ±2% accuracy e.g. 2.5V =2, =5, =2
		1	: Output voltage 100mV increments, within ±1% accuracy e.g. 5.0V =5, =0, =1
	Packages	M	: SOT-25 (for B and C types only)
		P	: SOT-89 (for D type only)
		P	: SOT-89-5 (for B and C types only)
		E	: USP-6C (for B and C types only)
		F	: SOT-223 (for D type only)
		J	: TO-252 (for D type only)
	Device Orientation	R	: Embossed tape, standard feed
		L	: Embossed tape, reverse feed

XE6216

DESIGNATOR	DESCRIPTION	SYMBOL	DESCRIPTION
	Type and Options of Regulators	B	: Fixed output voltage, High Active
		C	: Output voltage externally set, High Active
	Output Voltage	20 ~ 99	: For the voltage within 2.0V ~9.9V; e.g. 2.5V 25 5.0V 50
		A, B, C	: For the voltage above 10.0V; e.g. 10.6V A6 11.2V B2 12.0V C0
		20	: For C type (output voltage externally set), V _{OFB} =2.0V only
	Output Voltage Accuracy	2	: Output voltage 100mV increments, Within ±2% accuracy e.g. 2.5V =2, =5, =2
		1	: Output voltage 100mV increments, Within ±1% accuracy e.g. 5.0V =5, =0, =1
	Package	M	: SOT-25 (for B and C types only)
		P	: SOT-89 (for D type only)
		P	: SOT-89-5 (for B and C types only)
		E	: USP-6C (for B and C types only)
	Device Orientation	R	: Embossed tape, standard feed
		L	: Embossed tape, reverse feed

*1: The XE products are under development.

XC6216/XE6216 Series

BLOCK DIAGRAMS

XC6216B/XE6216B Series
(SOT-25, SOT-89-5, USP-6C)

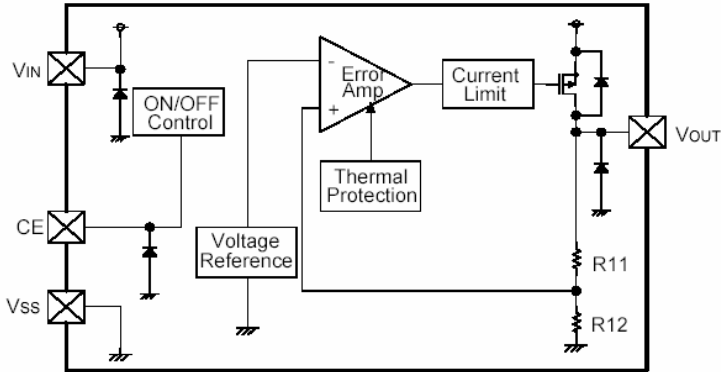

XC6216C/XE6216C Series
(SOT-25, SOT-89-5, USP-6C)

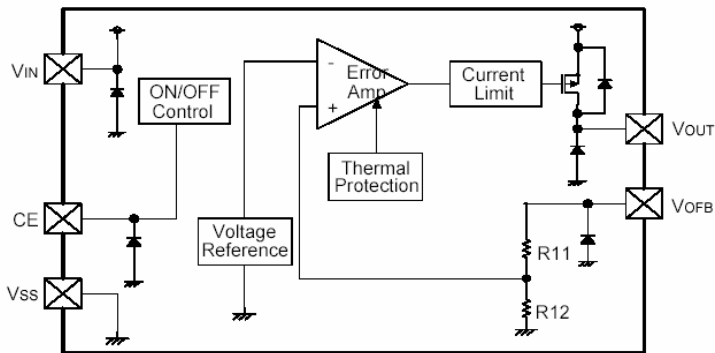

XC6216D/XE6216D Series
(SOT-89, SOT-223, TO-252)

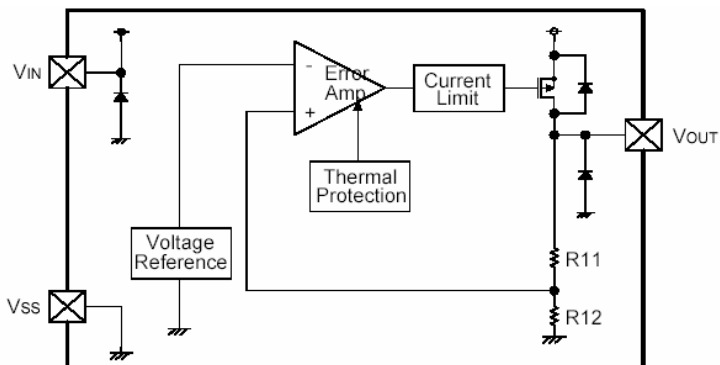

ABSOLUTE MAXIMUM RATINGS

XC6216B Series

PARAMETER	SYMBOL	RATINGS	UNIT
Input Voltage	V _{IN}	V _{SS} -0.3~30	V
Output Current	I _{OUT}	300 ^{(*)1}	mA
Output Voltage	V _{OUT}	V _{SS} -0.3~V _{IN} +0.3	V
CE Input Voltage	V _{CE}	V _{SS} -0.3~30	V
Power Dissipation	SOT-25	Pd	mW (T _J =25)
	SOT-89-5		
	USP-6C		
Operating Temperature Range	Topr	-40~+85	
Storage Temperature Range	Tstg	-55~+125	

*1: I_{OUT} Pd / (V_{IN}-V_{OUT})

XC6216C Series

PARAMETER	SYMBOL	RATINGS	UNIT
Input Voltage	V _{IN}	V _{SS} -0.3~30	V
Output Current	I _{OUT}	300 ^{(*)1}	mA
Output Voltage	V _{OUT}	V _{SS} -0.3~V _{IN} +0.3	V
CE Input Voltage	V _{CE}	V _{SS} -0.3 ~ 30	V
FB Voltage	V _{OFB}	V _{SS} -0.3 ~ 30	V
Power Dissipation	SOT-25	Pd	mW (T _J =25)
	SOT-89-5		
	USP-6C		
Operating Temperature Range	Topr	-40~+85	
Storage Temperature Range	Tstg	-55~+125	

*1: I_{OUT} Pd / (V_{IN}-V_{OUT})

XC6216D Series

PARAMETER	SYMBOL	RATINGS	UNIT
Input Voltage	V _{IN}	V _{SS} -0.3~30	V
Output Current	I _{OUT}	300 ^{(*)1}	mA
Output Voltage	V _{OUT}	V _{SS} -0.3~V _{IN} +0.3	V
Power Dissipation	SOT-89	Pd	mW (T _J =25)
	SOT-223		
	TO-252		
Operating Temperature Range	Topr	-40~+85	
Storage Temperature Range	Tstg	-55~+125	

*1: I_{OUT} Pd / (V_{IN}-V_{OUT})

*2: Only SOT-89 package is available for the XE series.

ELECTRICAL CHARACTERISTICS

XC6216B Series

Ta = 25

PARAMETER	SYMBOL	CONDITIONS	MIN.	TYP.	MAX.	UNIT	CIRCUIT
Output Voltage	V _{OUT(E)}	I _{OUT} =20mA, V _{CE} =V _{IN}	E-0			V	
Maximum Output Current	I _{OUTMAX}	V _{IN} =V _{OUT(T)} +3.0V, V _{CE} =V _{IN} (V _{OUT(T)} 3.0V)	150	-	-	mA	
		V _{IN} =V _{OUT(T)} +3.0V, V _{CE} =V _{IN} (V _{OUT(T)} < 3.0V)	100	-	-	mA	
Load Regulation	V _{OUT}	V _{IN} =V _{OUT(T)} +2.0V, 1mA I _{OUT} 50mA, V _{CE} =V _{IN} , (2.0V V _{OUT(T)} 7.0V)	-	50	90	mV	
		V _{IN} =V _{OUT(T)} +2.0V, 1mA I _{OUT} 50mA, V _{CE} =V _{IN} , (7.1V V _{OUT(T)} 12.0V)	-	110	140	mV	
Dropout Voltage 1	V _{dif1}	I _{OUT} =20mA, V _{CE} =V _{IN}	E-1			mV	
Dropout Voltage 2	V _{dif2}	I _{OUT} =100mA, V _{IN} = V _{OUT(T)} +3.0V, V _{CE} =V _{IN} (V _{OUT(T)} <3.0V)	E-2			mV	
		I _{OUT} =100mA, V _{CE} =V _{IN} (V _{OUT(T)} <3.0V)					
Supply Current	I _{SS}	V _{CE} =V _{IN}	1	5	9	μA	
Stand-by Current	I _{stby}	V _{CE} =V _{SS}	-	0.01	0.10	μA	
Line Regulation 1	V _{OUT} / V _{IN} · V _{OUT(T)}	V _{OUT(T)} +2.0V V _{IN} 28.0V I _{OUT} =5mA, V _{CE} =V _{IN}	0.01	0.05	0.10	%/V	
Line Regulation 2	V _{OUT} / V _{IN} · V _{OUT(T)}	V _{OUT(T)} +2.0V V _{IN} 28.0V I _{OUT} =13mA, V _{CE} =V _{IN}	0.03	0.15	0.30	%/V	
Input Voltage	V _{IN}		2.0	-	28.0	V	-
Output Voltage Temperature Characteristics	V _{OUT} / T _{opr} · V _{OUT(T)}	I _{OUT} =20mA, V _{CE} =V _{IN} -40 T _{opr} 85	-	± 100	-	ppm/	
Ripple Rejection Rate	PSRR	V _{IN} =[V _{OUT(T)} +2.0]V+0.5V _{p-pAC} I _{OUT} =20mA, f=1kHz, V _{CE} =V _{IN}	-	30	-	dB	
Short Current	I _{short}	V _{IN} =V _{OUT(T)} +2.0V, V _{CE} =V _{IN}	-	30	-	mA	
CE "H" Level Voltage	V _{CEH}	V _{IN} =28.0V	1.1	-	28.0	V	
CE "L" Level Voltage	V _{CEL}	V _{IN} =28.0V	0	-	0.35	V	
CE "H" Level Current	I _{CEH}	V _{IN} =V _{CE} =28.0V	-0.1	-	0.1	μA	
CE "L" Level Current	I _{CEL}	V _{IN} =28.0V, V _{CE} =V _{SS}	-0.1	-	0.1	μA	

Thermal Shutdown Detect Temperature	T _{TSD}	Junction Temperature	-	150	-		
Thermal Shutdown Release Temperature	T _{TSR}	Junction Temperature	-	125	-		
Hysteresis Range	T _{TSD} -T _{TSR}		-	25	-		-

NOTE:

*1: V_{OUT(T)}: Specified output voltage

*2: V_{OUT(E)}: Effective output voltage

(i.e. the output voltage when "V_{OUT(T)}+2.0V" is provided at the V_{IN} pin while maintaining a certain I_{OUT} value.)

*3: V_{dif}={V_{IN1}^{Note 5} - V_{OUT1}^{Note 4}}

*4: V_{OUT1}: A voltage equal to 98% of the output voltage whenever an amply stabilized I_{OUT}{V_{OUT(T)}+2.0V} is input.

*5: V_{IN1}: The input voltage when V_{OUT1} appears as input voltage is gradually decreased.

*6: Unless otherwise stated, V_{IN}=V_{OUT(T)}+2.0V.

ELECTRICAL CHARACTERISTICS (Continued)

XC6216C Series

Ta = 25

PARAMETER	SYMBOL	CONDITIONS	MIN.	TYP.	MAX.	UNIT	CIRCUIT
Output Voltage	V _{OUT(E)}	I _{OUT} =20mA, V _{CE} =V _{IN} , V _{OFB} =V _{OUT}	1.96	2.00	2.04	V	
Divided Resistor	RFB	V _{IN} =V _{OUT} =5.0V, V _{CE} =V _{SS} V _{OFB} =V _{OUT}	1.30	2.09	4.40	M	
Maximum Output Current	I _{OUTMAX}	V _{IN} =5.0V, V _{CE} =V _{IN} , V _{OFB} =V _{OUT}	100	-	-	mA	
Load Regulation	V _{OUT}	V _{IN} =4.0V 1mA I _{OUT} 50mA, V _{CE} =V _{IN} , V _{OFB} =V _{OUT}	-	50	90	mV	
Dropout Voltage1	V _{dif1}	I _{OUT} =20mA, V _{CE} =V _{IN} , V _{OFB} =V _{OUT}	-	450	600	mV	
Dropout Voltage2	V _{dif2}	I _{OUT} =100mA, V _{IN} =5.0V, V _{CE} =V _{IN} , V _{OFB} =V _{OUT}	-	1900	2600-	mV	
Supply Current	I _{SS}	V _{CE} =V _{IN} , V _{OFB} =V _{OUT}	1	5	9	μA	
Stand-by Current	I _{stby}	V _{CE} =V _{SS} , V _{OFB} =V _{OUT}	-	0.01	0.10	μA	
Line Regulation1	V _{OUT} / V _{IN} · V _{OUT(T)}	4.0V V _{IN} 28.0V, I _{OUT} =5mA, V _{CE} =V _{IN} , V _{OFB} =V _{OUT}	-	0.05	0.10	%/V	
Line Regulation2	V _{OUT} / V _{IN} · V _{OUT(T)}	4.0V V _{IN} 28.0V, I _{OUT} =13mA, V _{CE} =V _{IN} , V _{OFB} =V _{OUT}	-	0.15	0.30	%/V	
Input Voltage	V _{IN}		2.0	-	28.0	V	-
Output Voltage Temperature Characteristics	V _{OUT} / T _{opr} · V _{OUT(T)}	I _{OUT} =20mA, V _{CE} =V _{IN} , -40 T _{opr} 85	-	± 100	-	ppm/	
Ripple Rejection Rate	PSRR	V _{IN} =4.0V+0.5V _{p-pAC} , I _{OUT} =20mA, f=1kHz, V _{CE} =V _{IN} V _{OFB} =V _{OUT}	-	30	-	dB	
Short Current	I _{short}	V _{IN} =4.0V, V _{CE} =V _{IN} , V _{OFB} =V _{OUT}	-	30	-	mA	
CE "H" Level Voltage	V _{CEH}	V _{IN} =28.0V, V _{OFB} =V _{OUT}	1.1	-	28.0	V	
CE "L" Level Voltage	V _{CEL}	V _{IN} =28.0V, V _{OFB} =V _{OUT}	0	-	0.5	V	
CE "H" Level Current	I _{CEH}	V _{IN} =V _{CE} =28.0V, V _{OFB} =V _{OUT}	-0.1	-	0.1	μA	
CE "L" Level Current	I _{CEL}	V _{IN} =28.0V, V _{CE} =V _{SS} V _{OFB} =V _{OUT}	-0.1	-	0.1	μA	

Thermal Shutdown Detect Temperature	T _{TSD}	Junction Temperature	-	150	-		
Thermal Shutdown Release Temperature	T _{TSR}	Junction Temperature	-	125	-		
Hysteresis Range	T _{TSD} -T _{TSR}		-	25	-		-

NOTE:

*1: V_{OUT(T)}: Specified output voltage

*2: V_{OUT(E)}: Effective output voltage

(i.e. the output voltage when "V_{OUT(T)}+2.0V" is provided at the V_{IN} pin while maintaining a certain I_{OUT} value.)

*3: V_{dif}={V_{IN1}^{Note 5} - V_{OUT1}^{Note 4}}

*4: V_{OUT1}: A voltage equal to 98% of the output voltage whenever an amply stabilized I_{OUT}{V_{OUT(T)}+2.0V} is input.

*5: V_{IN1}: The input voltage when V_{OUT1} appears as input voltage is gradually decreased.

*6: Unless otherwise stated, V_{IN}=V_{OUT(T)}+2.0V.

ELECTRICAL CHARACTERISTICS (Continued)

XC6216D Series

Ta = 25

PARAMETER	SYMBOL	CONDITIONS	MIN.	TYP.	MAX.	UNIT	CIRCUIT
Output Voltage	V _{OUT(E)}	I _{OUT} =20mA	E-0			V	
Maximum Output Current	I _{OUTMAX}	V _{IN} =V _{OUT(T)} +3.0V, (V _{OUT(T)} 3.0V)	150	-	-	mA	
		V _{IN} =V _{OUT(T)} +3.0V, (V _{OUT(T)} < 3.0V)	100	-	-	mA	
Load Regulation	V _{OUT}	V _{IN} =V _{OUT(T)} +2.0V 1mA I _{OUT} 100mA	-	50	90	mV	
Dropout Voltage1	V _{dif1}	I _{OUT} =20mA	E-1			mV	
Dropout Voltage2	V _{dif2}	I _{OUT} =100mA, V _{IN} =V _{OUT(T)} +3.0V (V _{OUT(T)} < 3.0V)	E-2			mV	
		I _{OUT} =100mA, (V _{OUT(T)} 3.0V)					
Supply Current	I _{SS}		1	5	9	μA	
Line Regulation1	V _{OUT} / V _{IN} · V _{OUT(T)}	V _{OUT(T)} +2.0V V _{IN} 28.0V I _{OUT} =5mA	-	0.05	0.10	%/V	
Line Regulation2	V _{OUT} / V _{IN} · V _{OUT(T)}	V _{OUT(T)} +2.0V V _{IN} 28.0V I _{OUT} =13mA	-	0.15	0.30	%/V	
Input Voltage	V _{IN}		2.0	-	28.0	V	-
Output Voltage Temperature Characteristics	V _{OUT} / T _{opr} · V _{OUT(T)}	I _{OUT} =20mA, V _{CE} =V _{IN} -40 T _{opr} 85	-	± 100	-	ppm/	
Ripple Rejection Rate	PSRR	V _{IN} =[V _{OUT(T)} +2.0]V+0.5V _{p-pAC} I _{OUT} =20mA, f=1kHz	-	30	-	dB	
Short Current	I _{short}	V _{IN} =V _{OUT(T)} +2.0V	-	30	-	mA	
Thermal Shutdown Detect Temperature	T _{TSD}	Junction Temperature	-	150	-		-
Thermal Shutdown Release Temperature	T _{TSR}	Junction Temperature	-	125	-		-
Hysteresis Range	T _{TSD} -T _{TSR}		-	25	-		-

NOTE:

*1: V_{OUT(T)}: Specified output voltage

*2: V_{OUT(E)}: Effective output voltage

(i.e. the output voltage when "V_{OUT(T)}+2.0V" is provided at the V_{IN} pin while maintaining a certain I_{OUT} value.)

*3: V_{dif}={V_{IN1}^{Note 5} - V_{OUT1}^{Note 4}}

*4: V_{OUT1}: A voltage equal to 98% of the output voltage whenever an amply stabilized I_{OUT}{V_{OUT(T)}+2.0V} is input.

*5: V_{IN1}: The input voltage when V_{OUT1} appears as input voltage is gradually decreased.

*6: Unless otherwise stated, V_{IN}=V_{OUT(T)}+2.0V.

ELECTRICAL CHARACTERISTICS (Continued)

● Voltage Chart

PARAMETER SETTING VOLTAGE	E-0				E-1		E-2	
	OUTPUT VOLTAGE (V) 2% ACCURACY		OUTPUT VOLTAGE (V) 1% ACCURACY		DROPOUT VOLTAGE 1 (mV) I _{OUT} =20mA		DROPOUT VOLTAGE 2 (mV) I _{OUT} =100mA	
	V _{OUT}		V _{OUT}		Vdif1		Vdif2	
V _{OUT(T)} (V)	MIN.	MAX.	MIN.	MAX.	TYP.	MAX.	TYP.	MAX.
2.0	1.960	2.040	1.980	2.020	450	600	1900	2600
2.1	2.058	2.142	2.079	2.121	450	600	1900	2600
2.2	2.156	2.244	2.178	2.222	390	520	1700	2200
2.3	2.254	2.346	2.277	2.323	390	520	1700	2200
2.4	2.352	2.448	2.376	2.424	390	520	1700	2200
2.5	2.450	2.550	2.475	2.525	310	450	1500	1900
2.6	2.548	2.652	2.574	2.626	310	450	1500	1900
2.7	2.646	2.754	2.673	2.727	310	450	1500	1900
2.8	2.744	2.856	2.772	2.828	310	450	1500	1900
2.9	2.842	2.958	2.871	2.929	310	450	1500	1900
3.0	2.940	3.060	2.970	3.030	260	360	1300	1700
3.1	3.038	3.162	3.069	3.131	260	360	1300	1700
3.2	3.136	3.264	3.168	3.232	260	360	1300	1700
3.3	3.234	3.366	3.267	3.333	260	360	1300	1700
3.4	3.332	3.468	3.366	3.434	260	360	1300	1700
3.5	3.430	3.570	3.465	3.535	260	360	1300	1700
3.6	3.528	3.672	3.564	3.636	260	360	1300	1700
3.7	3.626	3.774	3.663	3.737	260	360	1300	1700
3.8	3.724	3.876	3.762	3.838	260	360	1300	1700
3.9	3.822	3.978	3.861	3.939	260	360	1300	1700
4.0	3.920	4.080	3.960	4.040	220	320	1100	1500
4.1	4.018	4.182	4.059	4.141	220	320	1100	1500
4.2	4.116	4.284	4.158	4.242	220	320	1100	1500
4.3	4.214	4.386	4.257	4.343	220	320	1100	1500
4.4	4.312	4.488	4.356	4.444	220	320	1100	1500
4.5	4.410	4.590	4.455	4.545	220	320	1100	1500
4.6	4.508	4.692	4.554	4.646	220	320	1100	1500
4.7	4.606	4.794	4.653	4.747	220	320	1100	1500
4.8	4.704	4.896	4.752	4.848	220	320	1100	1500
4.9	4.802	4.998	4.851	4.949	220	320	1100	1500

ELECTRICAL CHARACTERISTICS (Continued)

● Voltage Chart (Continued)

PARAMETER SETTING VOLTAGE	E-0				E-1		E-2	
	OUTPUT VOLTAGE (V) 2% ACCURACY		OUTPUT VOLTAGE (V) 1% ACCURACY		DROPOUT VOLTAGE 1 (mV) $I_{OUT}=20mA$		DROPOUT VOLTAGE 2 (mV) $I_{OUT}=100mA$	
	V_{OUT}		V_{OUT}		V_{dif1}		V_{dif2}	
$V_{OUT(T)}$ (V)	MIN.	MAX.	MIN.	MAX.	TYP.	MAX.	TYP.	MAX.
5.0	4.900	5.100	4.950	5.050	190	280	1000	1300
5.1	4.998	5.202	5.049	5.151	190	280	1000	1300
5.2	5.096	5.304	5.148	5.252	190	280	1000	1300
5.3	5.194	5.406	5.247	5.353	190	280	1000	1300
5.4	5.292	5.508	5.346	5.454	190	280	1000	1300
5.5	5.390	5.610	5.445	5.555	190	280	1000	1300
5.6	5.488	5.712	5.544	5.656	190	280	1000	1300
5.7	5.586	5.814	5.643	5.757	190	280	1000	1300
5.8	5.684	5.916	5.742	5.916	190	280	1000	1300
5.9	5.782	6.018	5.841	5.959	190	280	1000	1300
6.0	5.880	6.120	5.940	6.060	190	280	1000	1300
6.1	5.978	6.222	6.039	6.161	190	280	1000	1300
6.2	6.076	6.324	6.138	6.262	190	280	1000	1300
6.3	6.174	6.426	6.237	6.363	190	280	1000	1300
6.4	6.272	6.528	6.336	6.464	190	280	1000	1300
6.5	6.370	6.630	6.435	6.565	170	230	800	1150
6.6	6.468	6.732	6.534	6.666	170	230	800	1150
6.7	6.566	6.834	6.633	6.767	170	230	800	1150
6.8	6.664	6.936	6.732	6.868	170	230	800	1150
6.9	6.762	7.038	6.831	6.969	170	230	800	1150
7.0	6.860	7.140	6.930	7.070	170	230	800	1150
7.1	6.958	7.242	7.029	7.171	170	230	800	1150
7.2	7.056	7.344	7.128	7.272	170	230	800	1150
7.3	7.154	7.446	7.227	7.373	170	230	800	1150
7.4	7.252	7.548	7.326	7.474	170	230	800	1150
7.5	7.350	7.650	7.425	7.575	170	230	800	1150
7.6	7.448	7.752	7.524	7.676	170	230	800	1150
7.7	7.546	7.854	7.623	7.777	170	230	800	1150
7.8	7.644	7.956	7.722	7.878	170	230	800	1150
7.9	7.742	8.058	7.821	7.979	170	230	800	1150
8.0	7.840	8.160	7.920	8.080	170	230	800	1150

ELECTRICAL CHARACTERISTICS (Continued)

● Voltage Chart (Continued)

PARAMETER SETTING VOLTAGE	E-0				E-1		E-2	
	OUTPUT VOLTAGE (V) 2% ACCURACY		OUTPUT VOLTAGE (V) 1% ACCURACY		DROPOUT VOLTAGE 1 (mV) I _{OUT} =20mA		DROPOUT VOLTAGE 2 (mV) I _{OUT} =100mA	
	V _{OUT(T)} (V)		V _{OUT}		V _{dif1}		V _{dif2}	
	MIN.	MAX.	MIN.	MAX.	TYP.	MAX.	TYP.	MAX.
8.1	7.938	8.262	8.019	8.181	130	190	700	950
8.2	8.036	8.364	8.118	8.282	130	190	700	950
8.3	8.134	8.466	8.217	8.383	130	190	700	950
8.4	8.232	8.568	8.316	8.484	130	190	700	950
8.5	8.330	8.670	8.415	8.585	130	190	700	950
8.6	8.428	8.772	8.514	8.686	130	190	700	950
8.7	8.526	8.874	8.613	8.787	130	190	700	950
8.8	8.624	8.976	8.712	8.888	130	190	700	950
8.9	8.722	9.078	8.811	8.989	130	190	700	950
9.0	8.820	9.180	8.910	9.090	130	190	700	950
9.1	8.918	9.282	9.009	9.191	130	190	700	950
9.2	9.016	9.384	9.108	9.292	130	190	700	950
9.3	9.114	9.486	9.207	9.393	130	190	700	950
9.4	9.212	9.588	9.306	9.494	130	190	700	950
9.5	9.310	9.690	9.405	9.595	130	190	700	950
9.6	9.408	9.792	9.504	9.696	130	190	700	950
9.7	9.506	9.894	9.603	9.797	130	190	700	950
9.8	9.604	9.996	9.702	9.898	130	190	700	950
9.9	9.702	10.098	9.801	9.999	130	190	700	950
10.0	9.800	10.200	9.900	10.100	130	190	700	950
10.1	9.898	10.302	9.999	10.201	120	160	650	850
10.2	9.996	10.404	10.098	10.302	120	160	650	850
10.3	10.094	10.506	10.197	10.403	120	160	650	850
10.4	10.192	10.608	10.296	10.504	120	160	650	850
10.5	10.290	10.710	10.395	10.605	120	160	650	850
10.6	10.388	10.812	10.494	10.706	120	160	650	850
10.7	10.486	10.914	10.593	10.807	120	160	650	850
10.8	10.584	11.016	10.692	10.908	120	160	650	850
10.9	10.682	11.118	10.791	11.009	120	160	650	850
11.0	10.780	11.220	10.890	11.110	120	160	650	850
11.1	10.878	11.322	10.989	11.211	120	160	650	850
11.2	10.976	11.424	11.088	11.312	120	160	650	850
11.3	11.074	11.526	11.187	11.413	120	160	650	850
11.4	11.172	11.628	11.286	11.514	120	160	650	850
11.5	11.270	11.730	11.385	11.615	120	160	650	850
11.6	11.368	11.832	11.484	11.716	120	160	650	850
11.7	11.466	11.934	11.583	11.817	120	160	650	850
11.8	11.564	12.036	11.682	11.918	120	160	650	850
11.9	11.662	12.138	11.781	12.019	120	160	650	850
12.0	11.760	12.240	11.880	12.120	120	160	650	850

OPERATIONAL EXPLANATION

<Output Voltage Control>

The voltage divided by resistors R11 & R12 is compared with the internal reference voltage by the error amplifier. The P-channel MOSFET, which is connected to the V_{OUT} pin, is then driven by the subsequent output signal. The output voltage at the V_{OUT} pin is controlled and stabilized by a system of negative feedback. The current limit circuit and short protect circuit operate in relation to the level of output current and heat dissipation. Further, the IC's internal circuitry can be shutdown via the CE pin's signal.

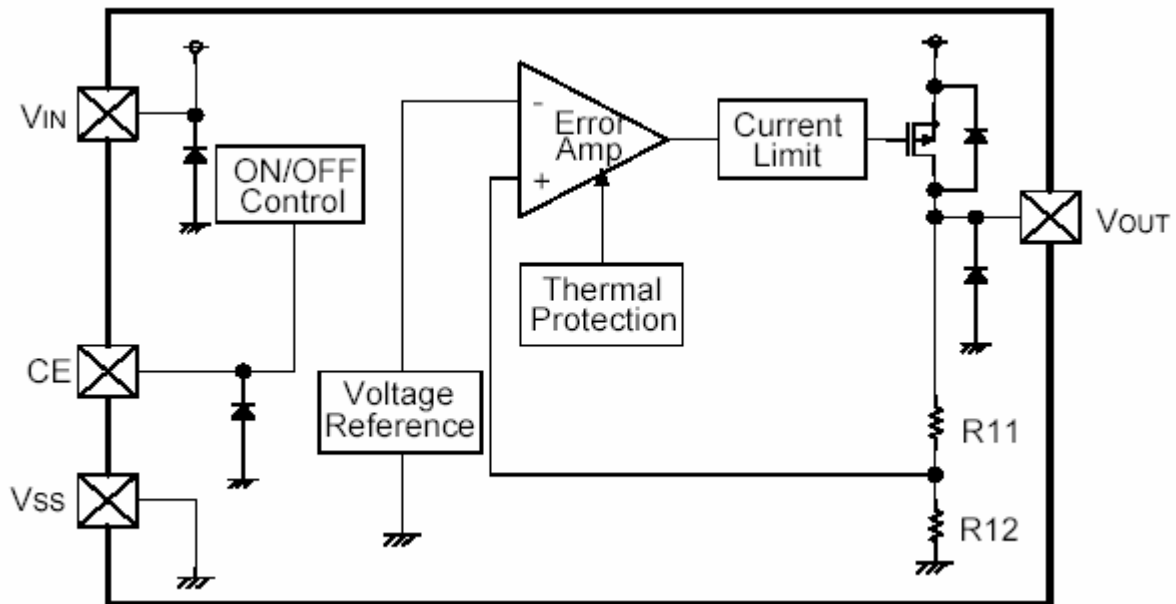

<Short-Circuit Protection>

The XC6216/XE6216 series includes a current fold-back circuit as a short circuit protection. When the load current reaches the current limit level, the current fold-back circuit operates and output voltage drops. The output voltage drops further and output current decreases. When the output pin is shorted, a current of about 30mA flows.

<CE Pin>

The IC's internal circuitry can be shutdown via the signal from the CE pin with the XC6216/XE6216 series. In shutdown mode, output at the V_{OUT} pin will be pulled down by R11 and R12 to the V_{SS} level. Note that as the XC6216/XE6216 series is 'High Active/No pull down', operations will become unstable with the CE pin open. We suggest that you use this IC with either a V_{IN} voltage or a V_{SS} voltage input at the CE pin. If this IC is used with the correct specifications for the CE pin, the operational logic is fixed and the IC will operate normally. However, supply current may increase as a result of through current in the IC's internal circuitry if a medium voltage is applied.

<Thermal Shutdown>

When the junction temperature of the built-in driver transistor reaches the temperature limit level (150 °C TYP.), the thermal shutdown circuit operates and the driver transistor will be set to OFF. The IC resumes its operation when the thermal shutdown function is released and the IC's operation is automatically restored because the junction temperature drops to the level of the thermal shutdown release voltage.

<Minimum Operating Voltage>

For the stable operation of the IC, over 2.0V of input voltage is necessary. The output voltage may not be generated normally if the input voltage is less than 2.0V.

NOTES ON USE

1. Please use this IC within the stated absolute maximum ratings. The IC is liable to malfunction should the ratings be exceeded.
2. Where wiring impedance is high, operations may become unstable due to the noise and/or phase lag depending on output current. Please strengthen V_{IN} and V_{SS} wiring in particular.
3. Phase compensation inside the IC is performed in the XC6216/XE6216 series. Therefore, an abnormal oscillation does not occur even if there is no output capacitor C_L . An input capacitor C_{IN} around 0.1 μ F~1.0 μ F between the V_{IN} pin and the V_{SS} pin is required for input stability. Also, the output voltage fluctuation such as under shoot or over shoot, which occurs because of the load change can be controlled by placing the output capacitor C_L around 0.1 μ F~1.0 μ F between the V_{OUT} pin and V_{SS} pin. The input capacitor (C_{IN}) and the output capacitor (C_L) should be placed to the IC as close as possible with a shorter wiring.
4. Notes on Setting Output Voltage Externally (C type) $T_{opr}=25$

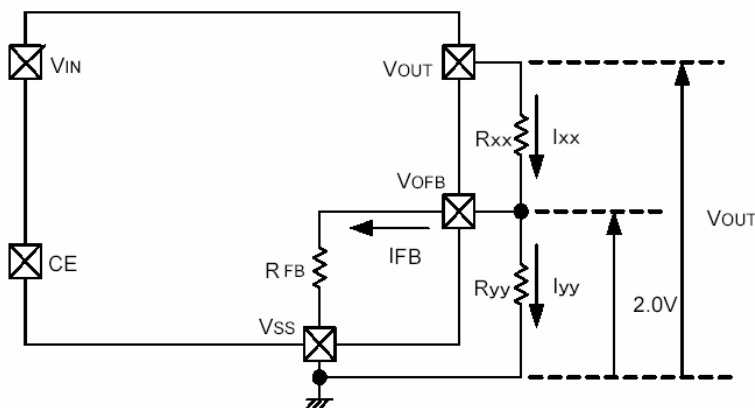

The output voltage can be set externally by the following equation:

$$V_{OUT} = 2.0V \times (R_{XX} + R_{YY}) / R_{YY} \quad (1)$$

Although the output voltage can be set freely by the above equation, resistance values can be calculated by the following equations in case considering output voltage accuracy.

$$I_{XX} = I_{FB} + I_{YY} \quad (2)$$

$$I_{YY} = 2.0V / R_{YY} \quad (3)$$

If the equation (3) is assigned to the equation (2), the equation becomes as below:

$$I_{XX} = I_{FB} + 2.0V / R_{YY} \quad (4)$$

For this, the following equation can be used for setting output voltage externally:

$$V_{OUT} = 2.0V + R_{XX} \cdot I_{XX} \quad (5)$$

And the equation (4) will be;

$$\begin{aligned} V_{OUT} &= 2.0V + R_{XX} \cdot (I_{FB} + 2.0V / R_{YY}) \\ &= 2.0V \times (1 + R_{XX} / R_{YY}) + R_{XX} \cdot I_{FB} \end{aligned} \quad (6)$$

The second term of the equation (6), $R_{XX} \cdot I_{FB}$, is the cause of the output accuracy error.

The I_{FB} can be calculated by the following equation:

$$I_{FB} = 2.0V / R_{FB} \quad (7)$$

The cause of the output accuracy error, $R_{XX} \cdot I_{FB}$ can be calculated by the equation below;

$$\begin{aligned} R_{XX} \cdot I_{FB} &= R_{XX} \cdot 2.0V / R_{FB} \\ &= 2.0V \times R_{XX} \cdot R_{FB} \end{aligned} \quad (8)$$

Accordingly, if R_{XX} is smaller than R_{FB} , the output voltage error becomes minute.

Setting Resistance-Dependant of XC6216 Series' Output Voltage

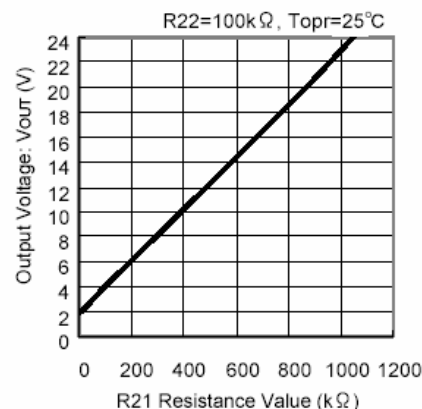
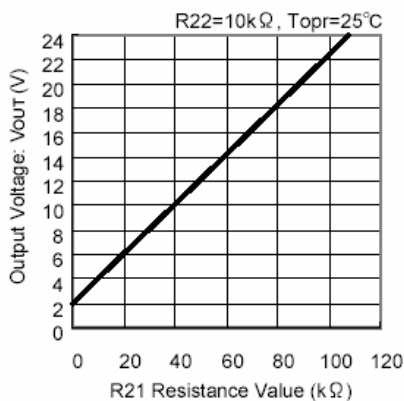
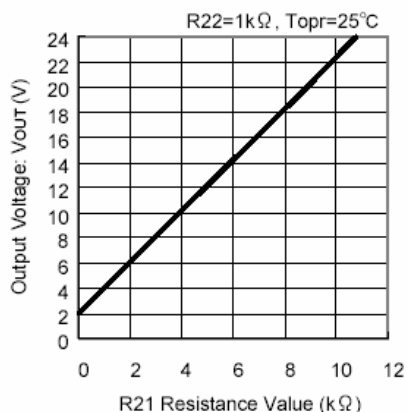

TEST CIRCUITS

Circuit

XC6216B/XE6216B Series

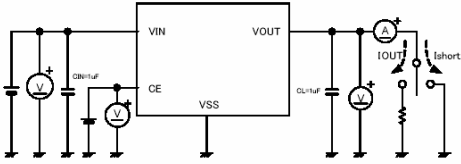

XC6216C/XE6216C Series

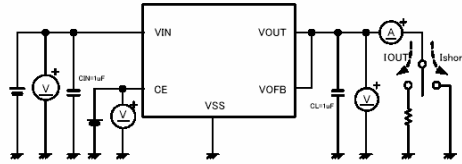

XC6216D/XE6216D Series

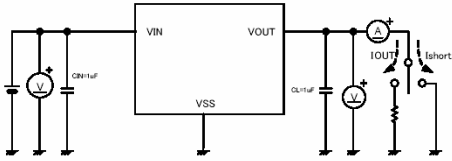

Circuit

XC6216B/XE6216B Series

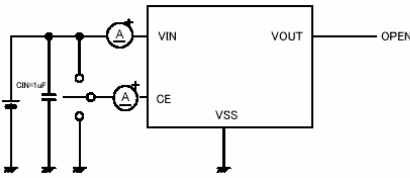

XC6216C/XE6216C Series

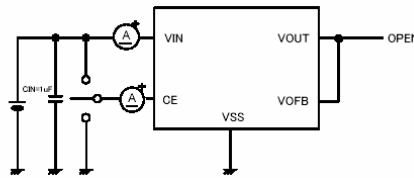

XC6216D/XE6216D Series

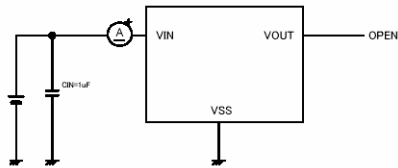

Circuit

XC6216B/XE6216B Series

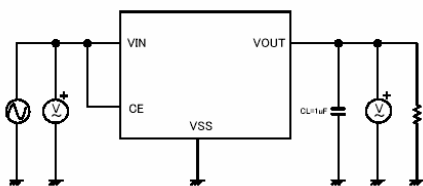

XC6216C/XE6216C Series

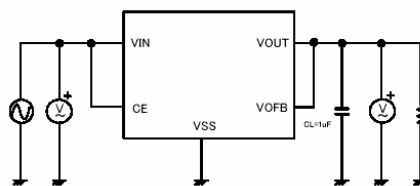

XC6216D/XE6216D Series

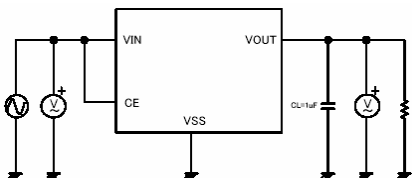

Circuit

XC6216C/XE6216C Series

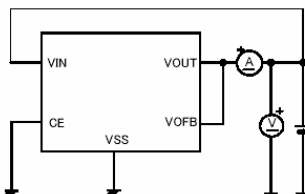

TYPICAL PERFORMANCE CHARACTERISTICS

(1) Output Voltage vs. Output Current

XC6216B/C/D 202

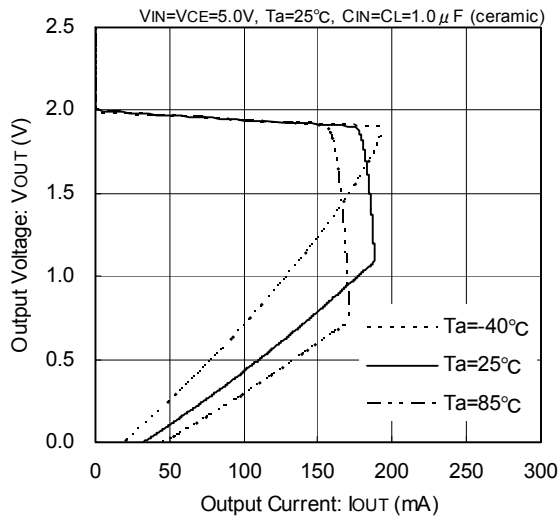

XC6216B/C/D 202

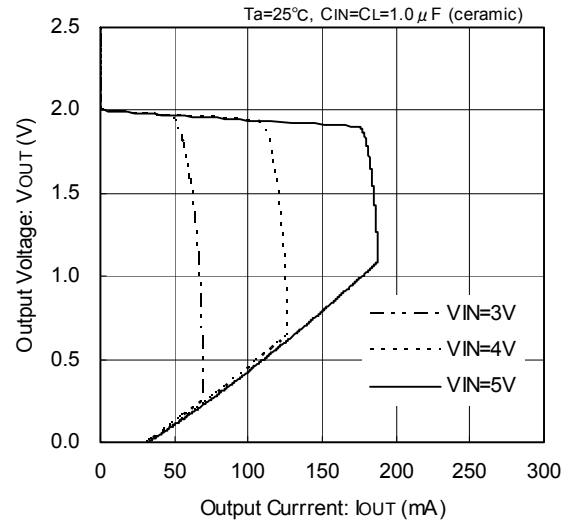

XC6216B/D 332

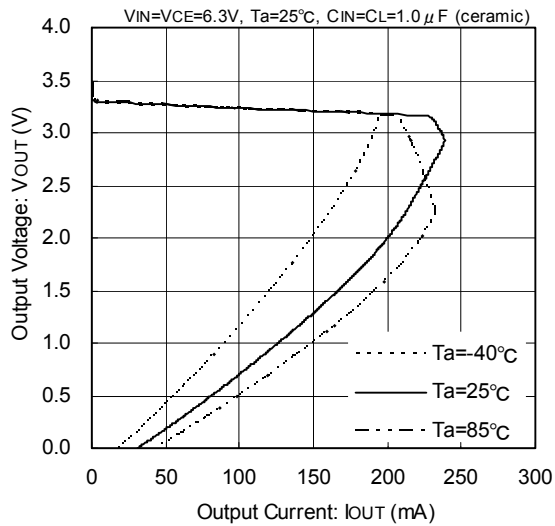

XC6216B/D 332

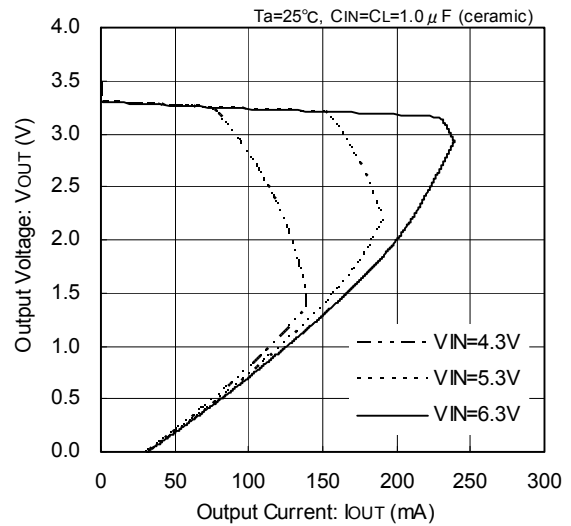

XC6216B/D 502

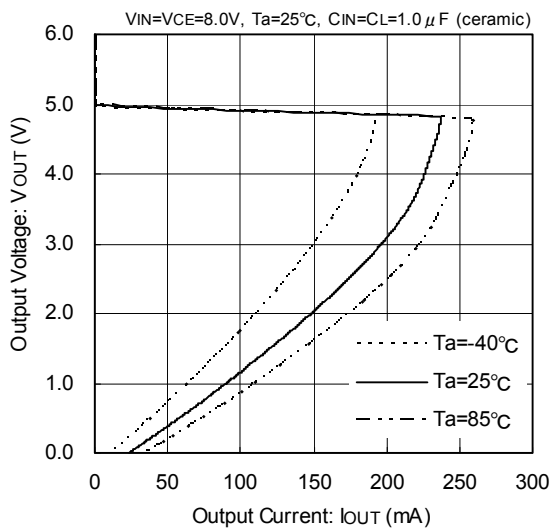

XC6216B/D 502

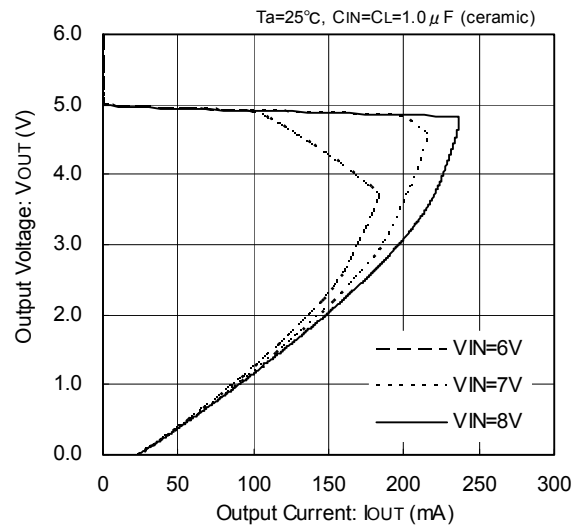

TYPICAL PERFORMANCE CHARACTERISTICS (Continued)

(1) Output Voltage vs. Output Current (Continued)

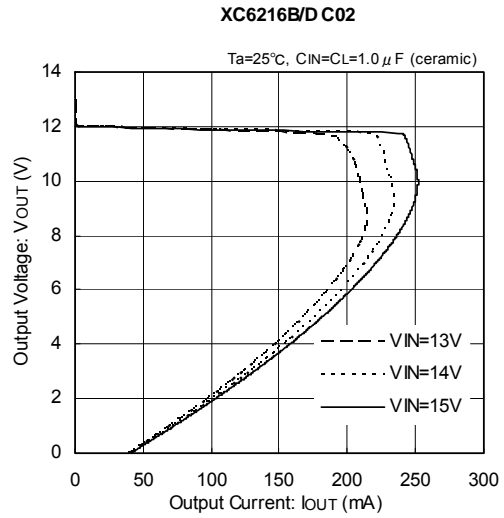
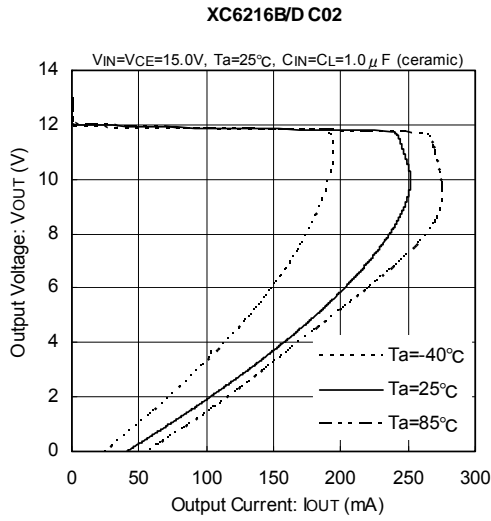

(2) Output Voltage vs. Input Voltage

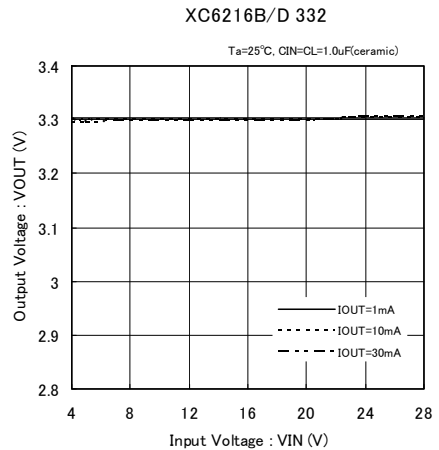
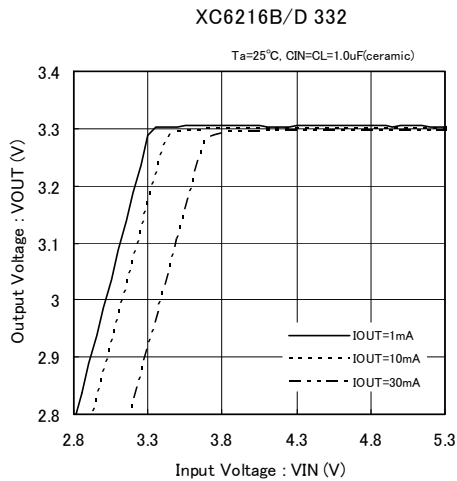
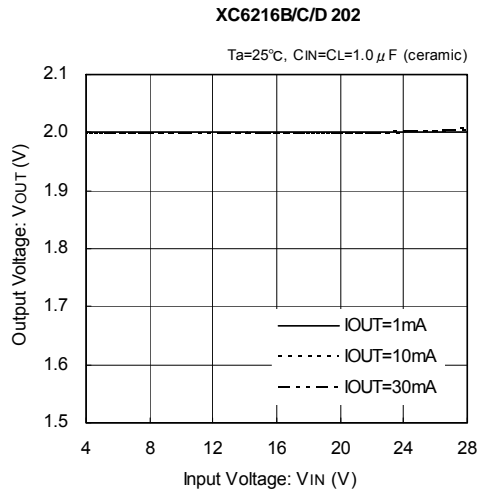
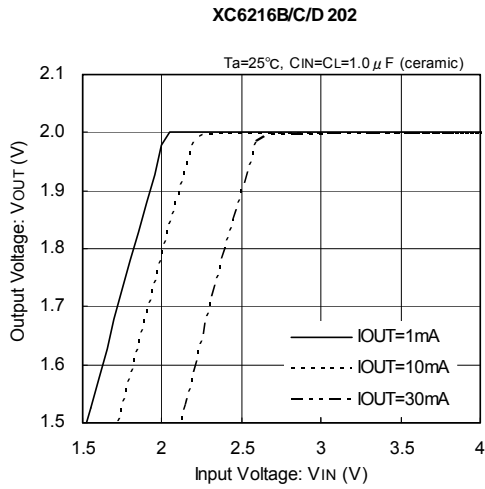

TYPICAL PERFORMANCE CHARACTERISTICS (Continued)

(2) Output Voltage vs. Input Voltage (Continued)

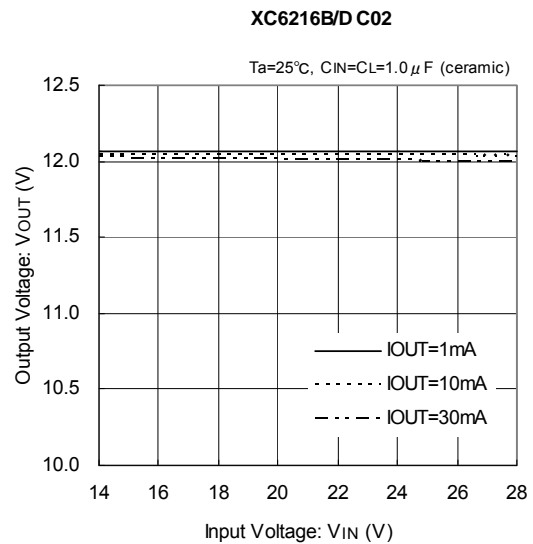
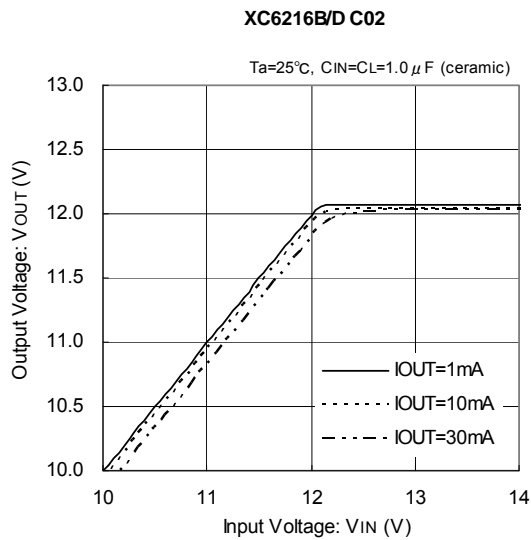
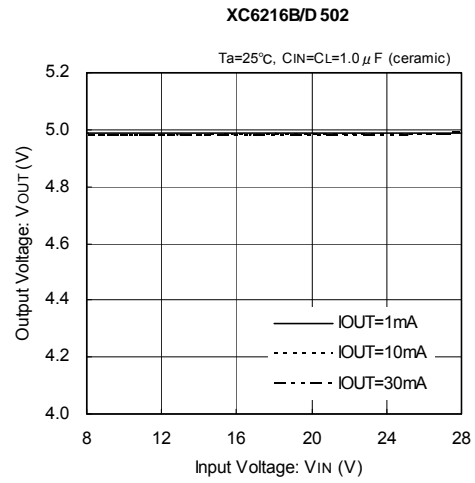
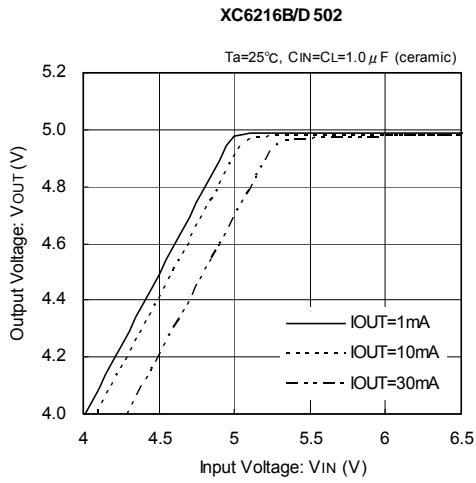

(3) Dropout Voltage vs. Output Current

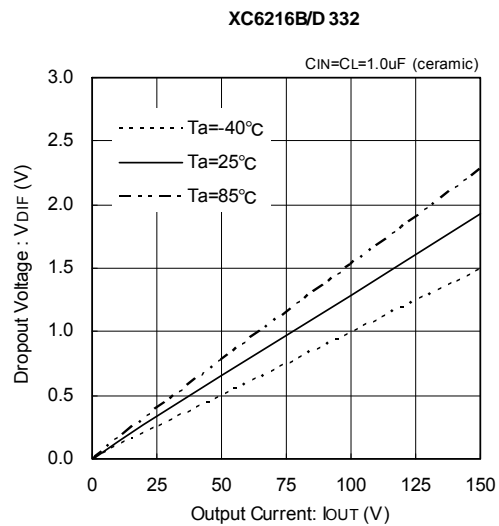
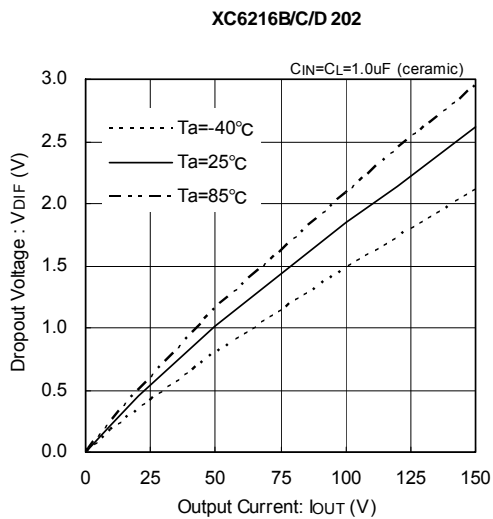

TYPICAL PERFORMANCE CHARACTERISTICS (Continued)

(3) Dropout Voltage vs. Output Current

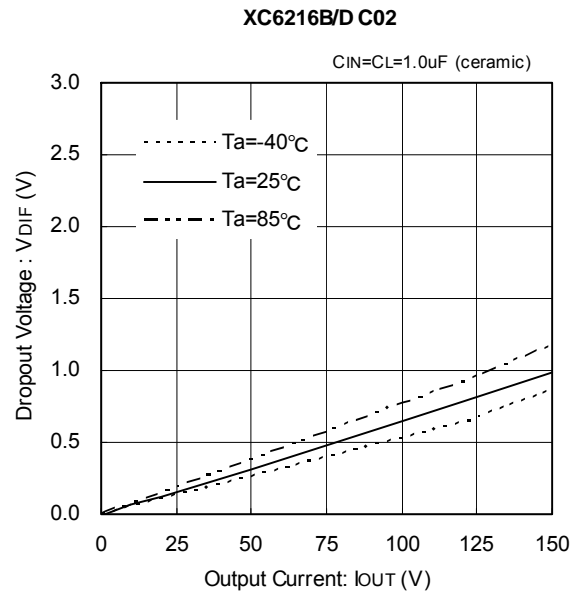
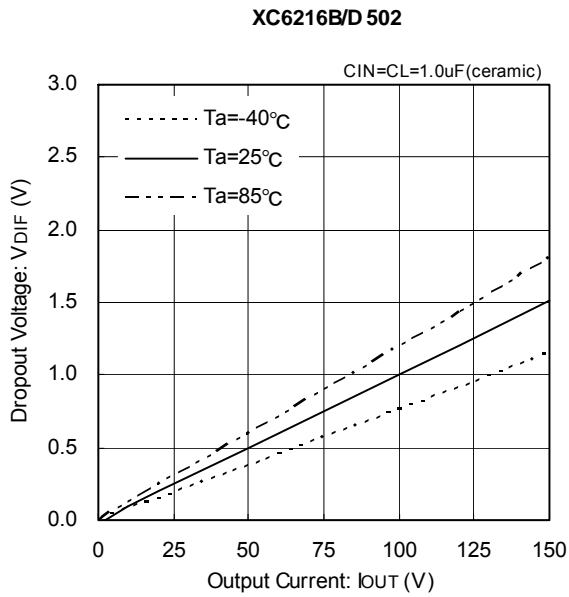

(4) Supply Current vs. Input Voltage

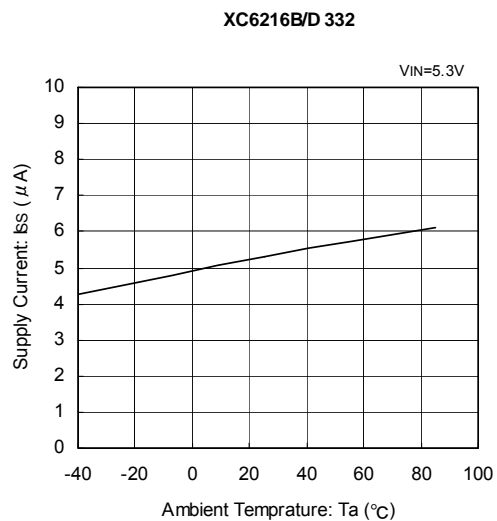
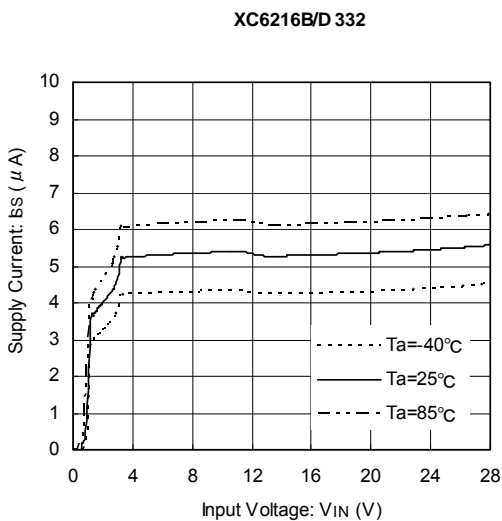
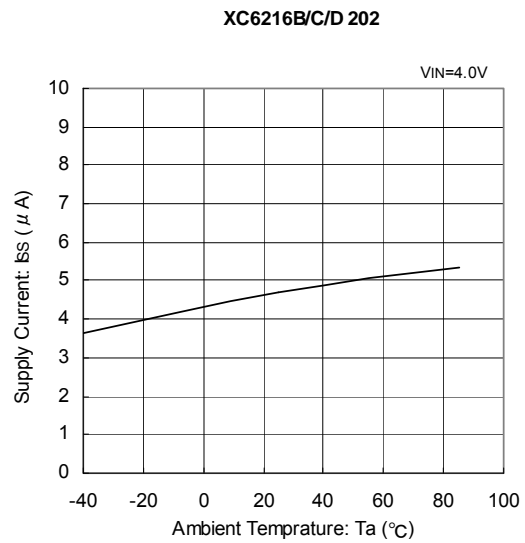
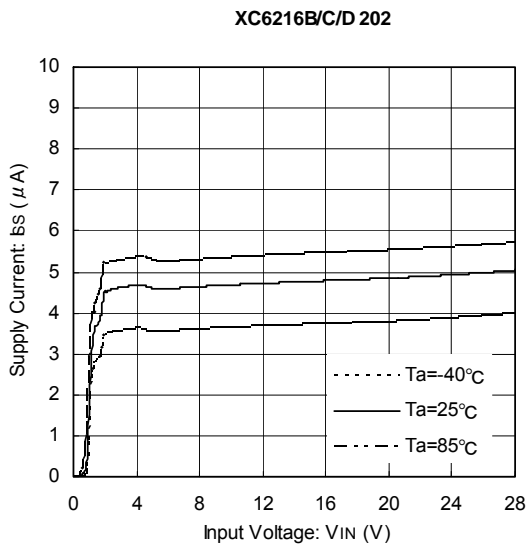

TYPICAL PERFORMANCE CHARACTERISTICS (Continued)

(4) Supply Current vs. Input Voltage (Continued)

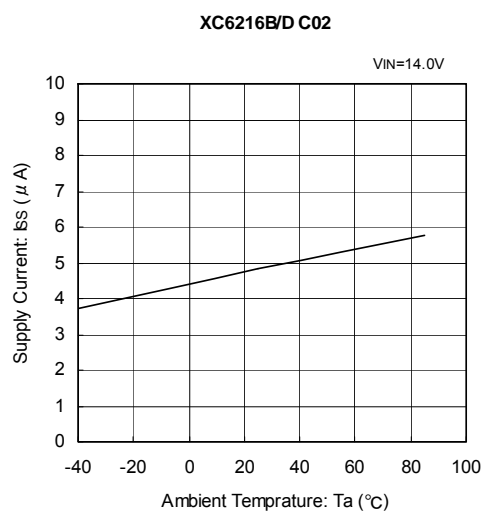
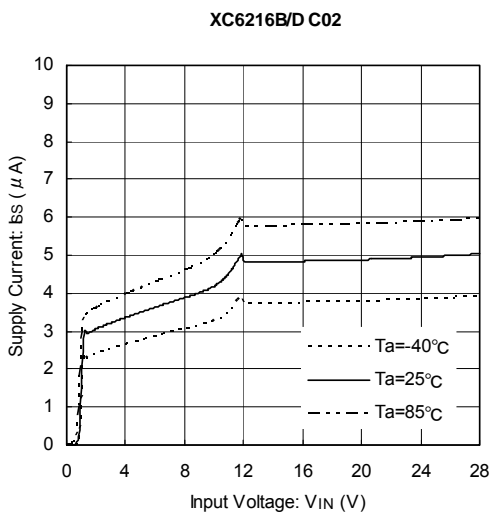
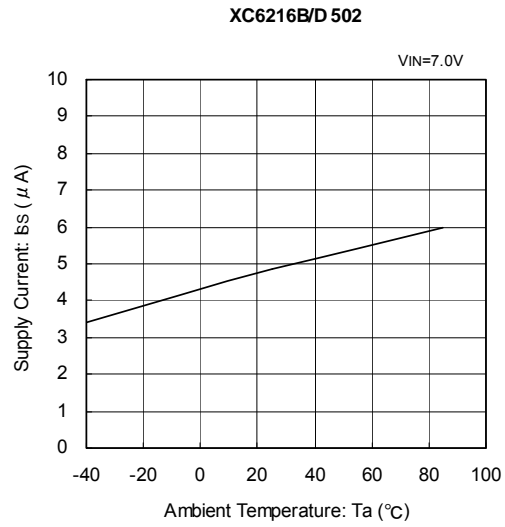
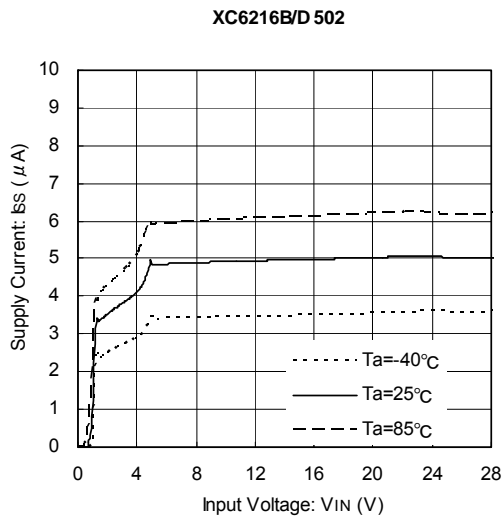

(5) Output Voltage vs. Ambient Temperature

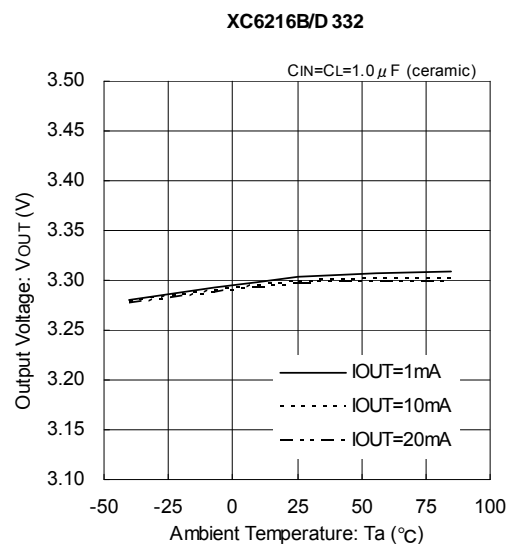
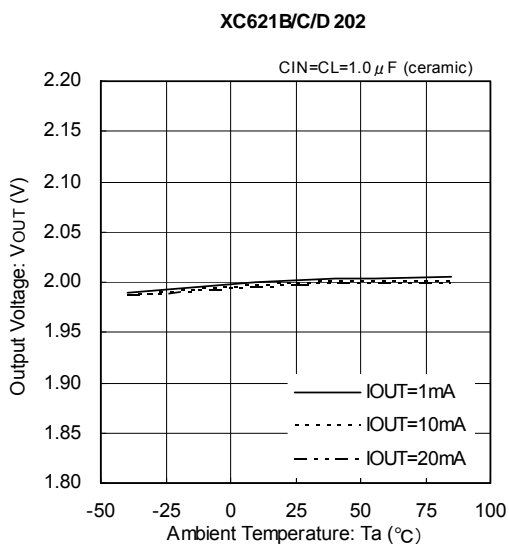

TYPICAL PERFORMANCE CHARACTERISTICS (Continued)

(5) Output Voltage vs. Ambient Temperature

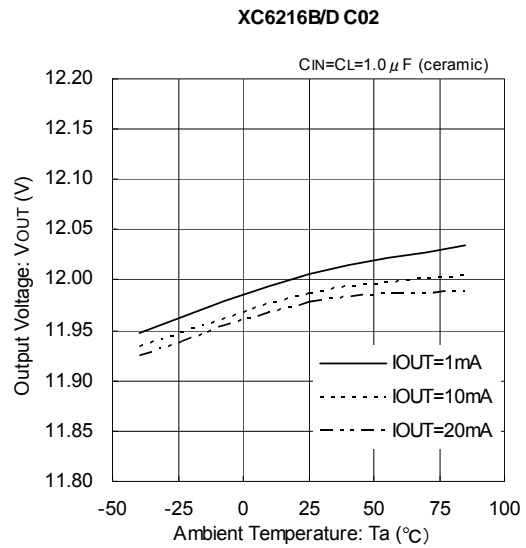
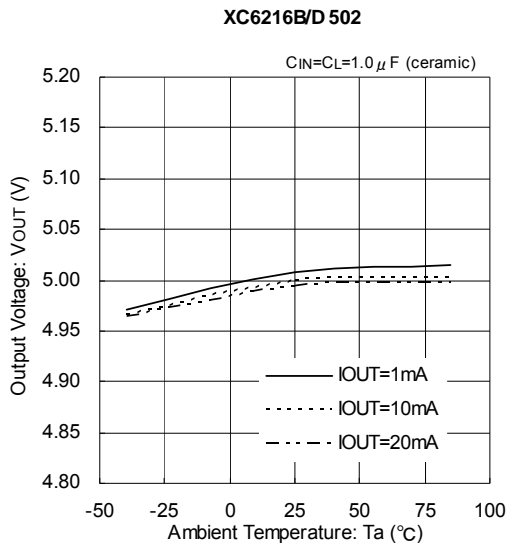

(6) Line Transient Response

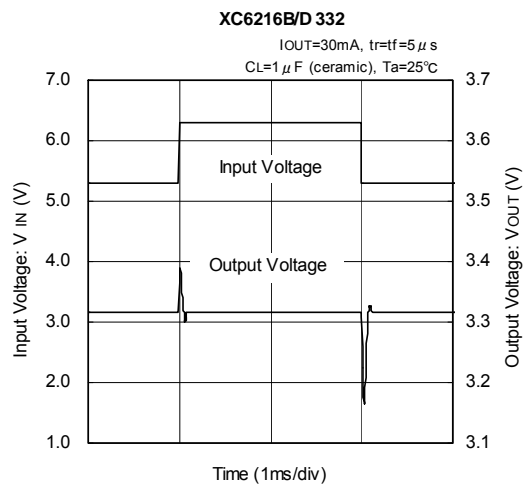
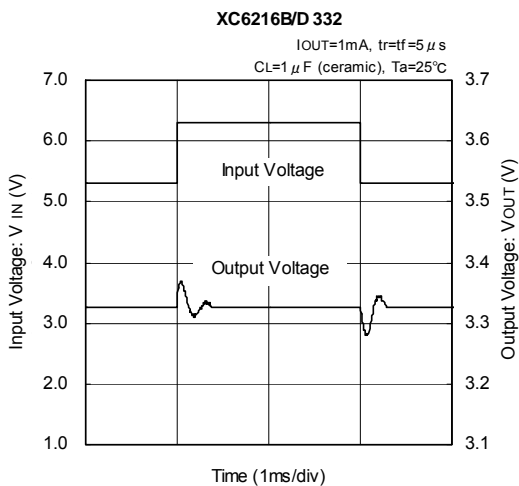
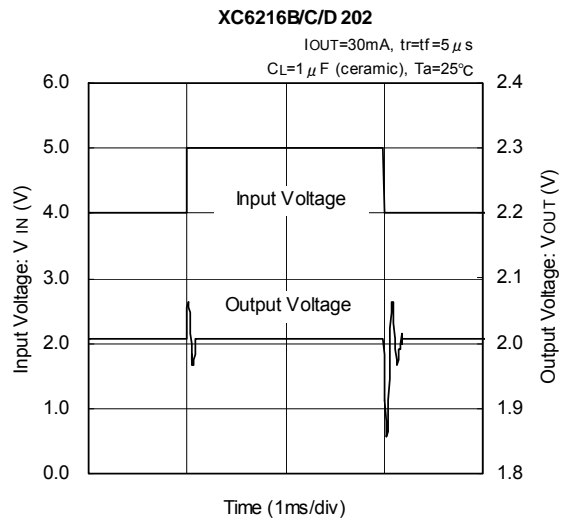
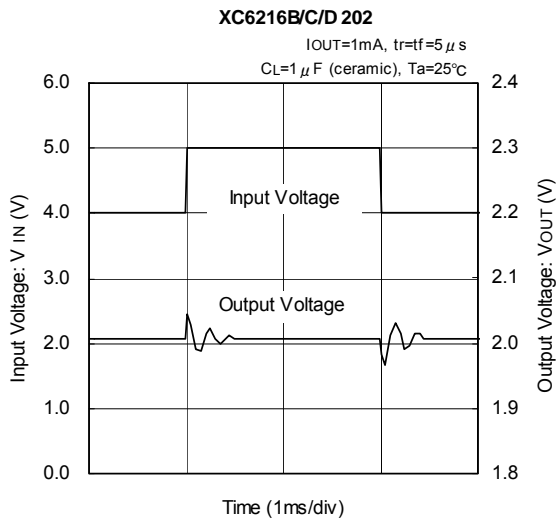

TYPICAL PERFORMANCE CHARACTERISTICS (Continued)

(6) Line Transient Response (Continued)

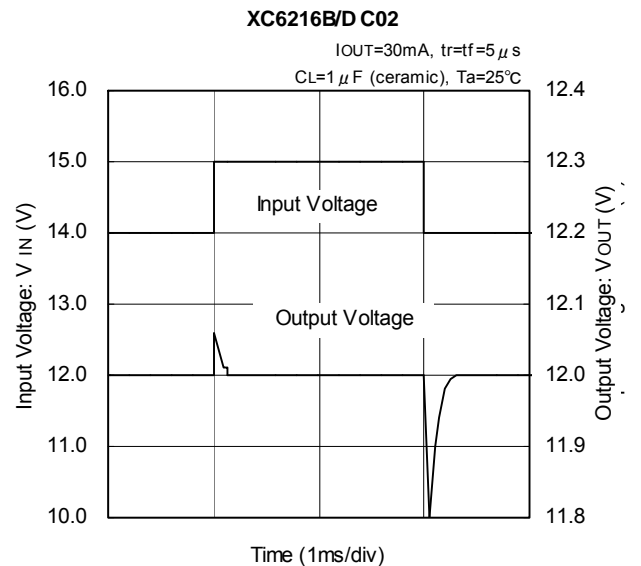
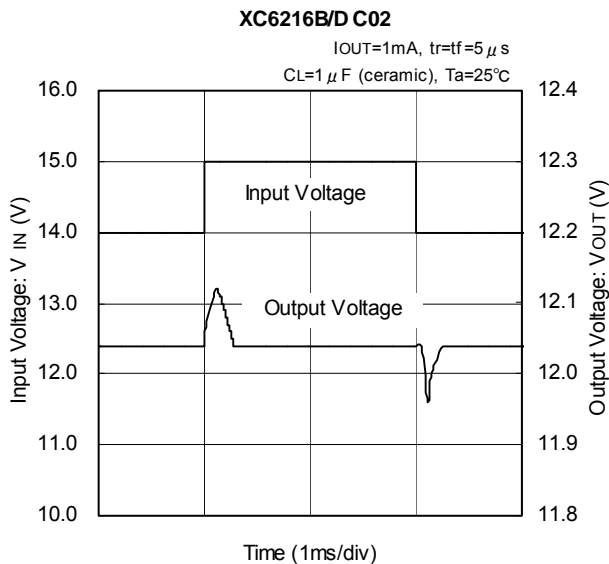
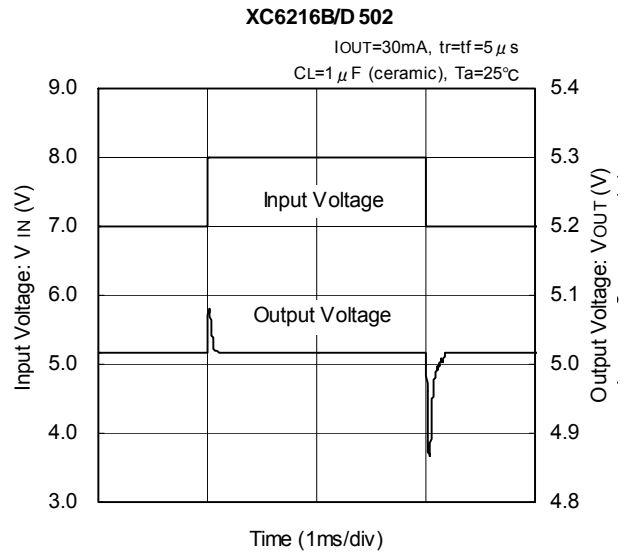
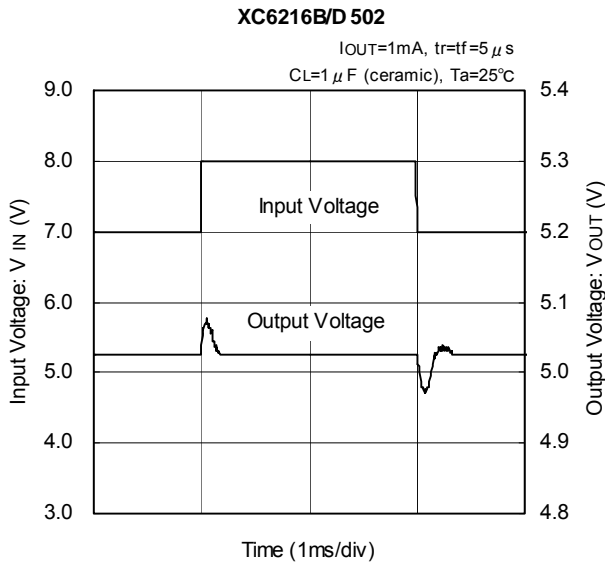

(7) Load Transient Response

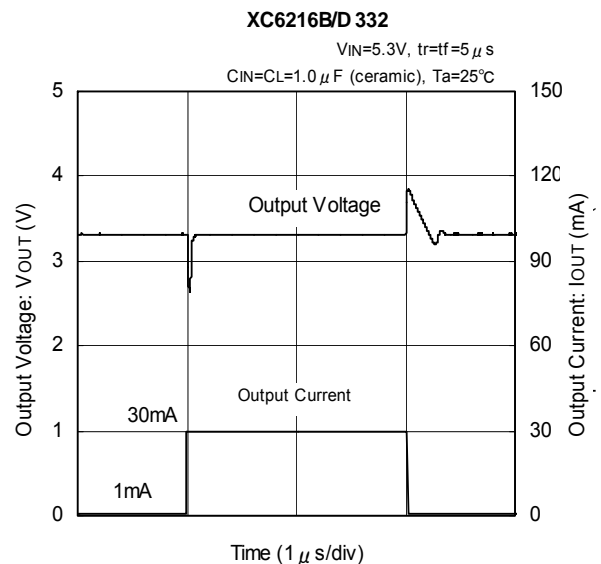
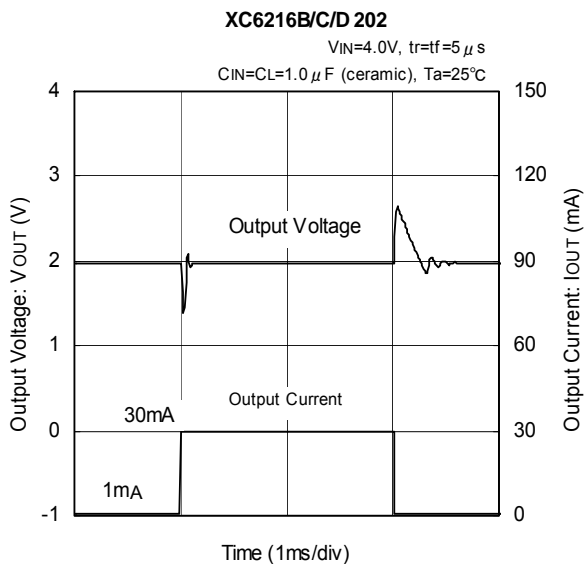

TYPICAL PERFORMANCE CHARACTERISTICS (Continued)

(7) Load Transient Response (Continued)

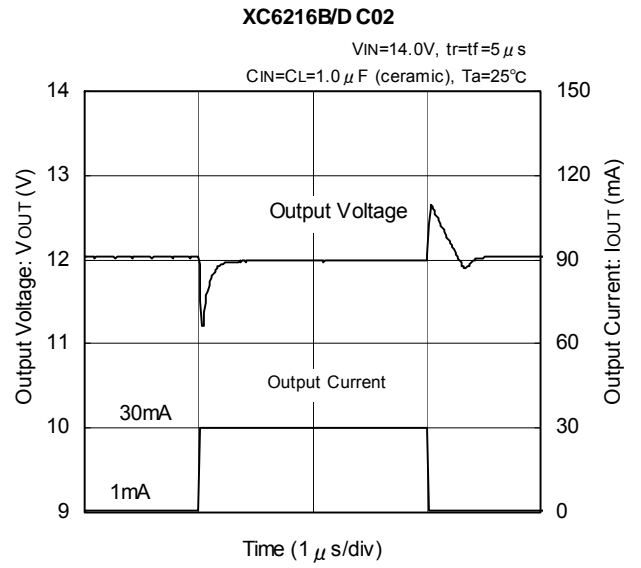
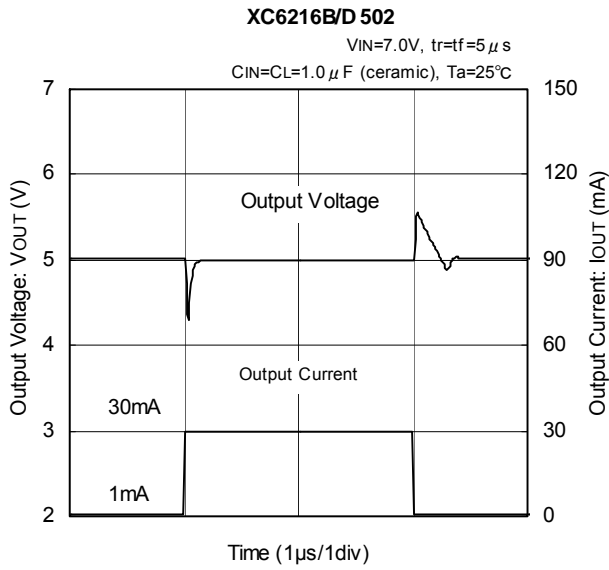

(8) Input Rise Time

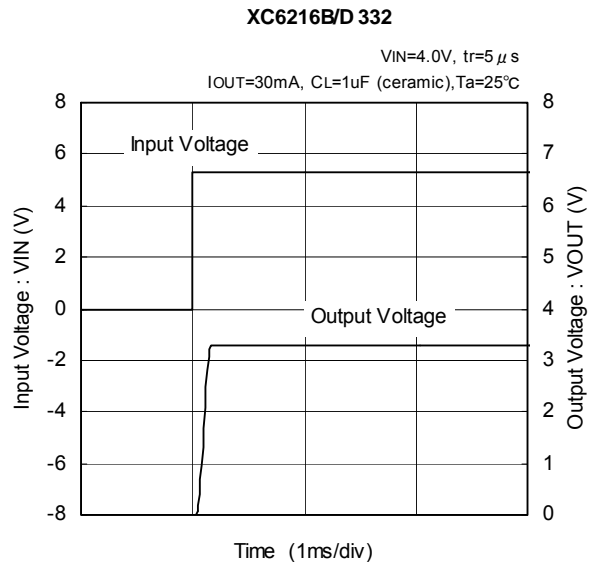
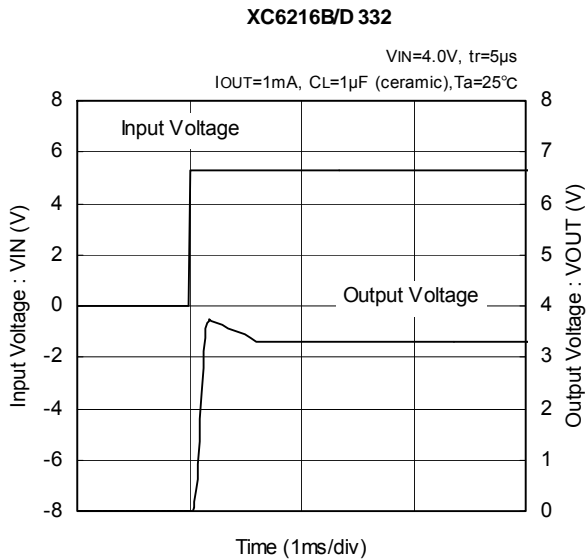
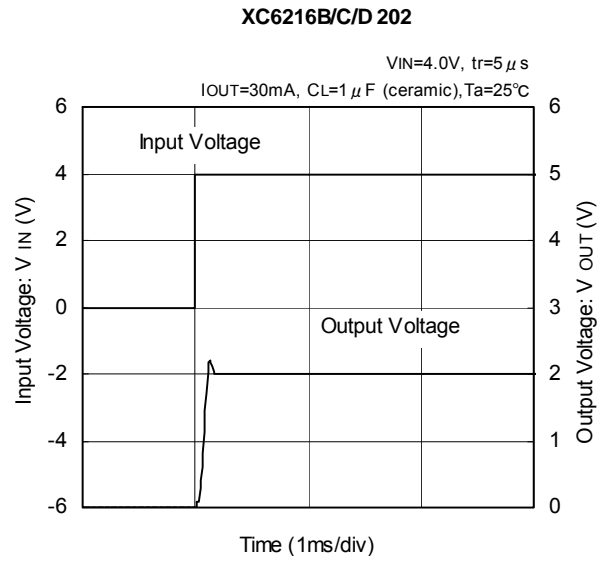
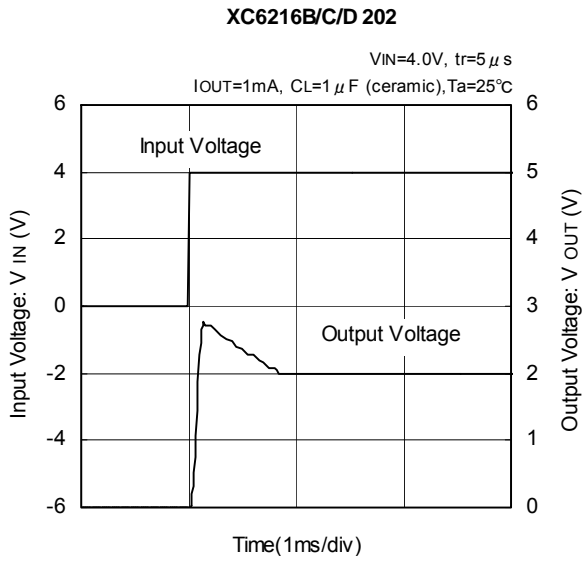

TYPICAL PERFORMANCE CHARACTERISTICS (Continued)

(8) Input Rise Time (Continued)

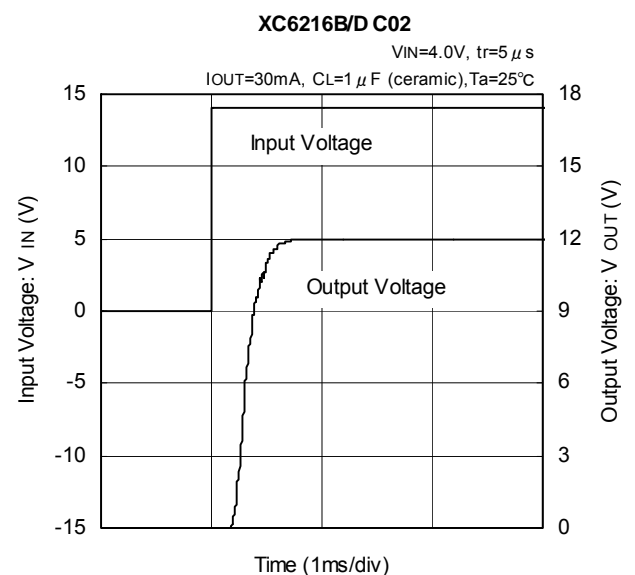
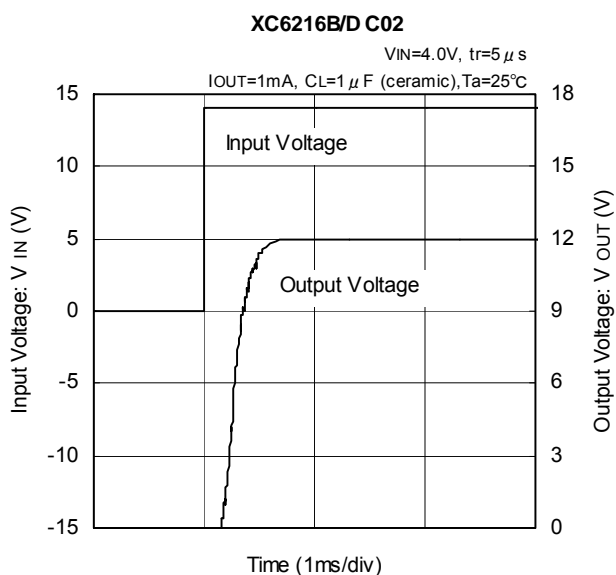
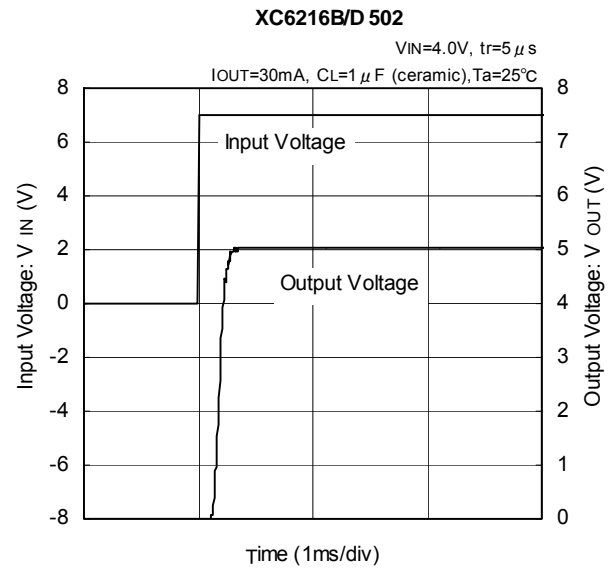
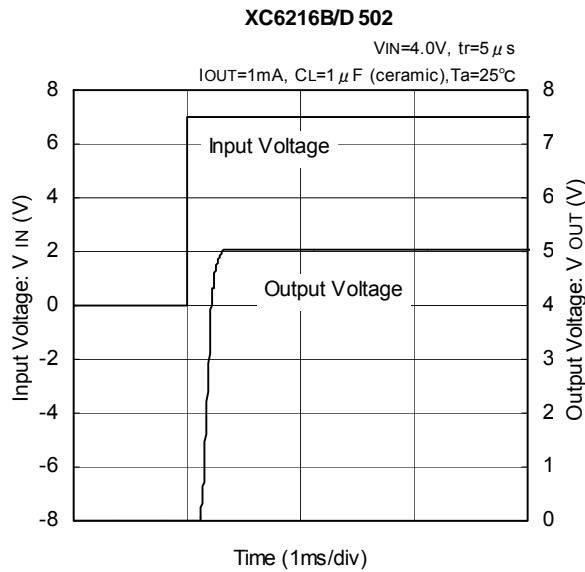

(9) CE Rise Time

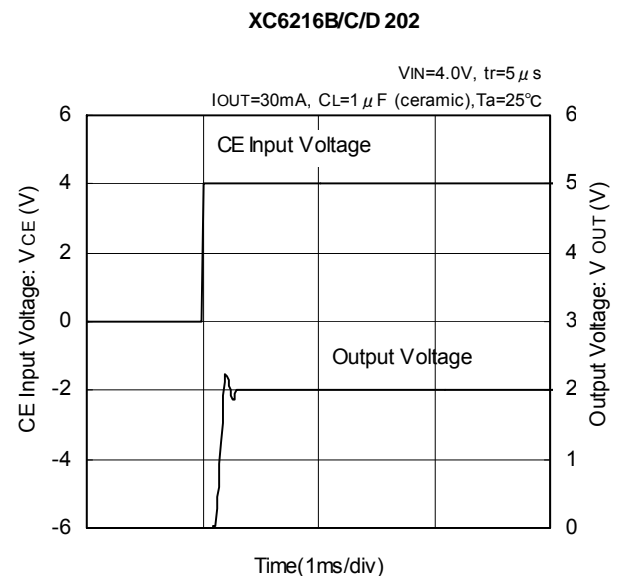
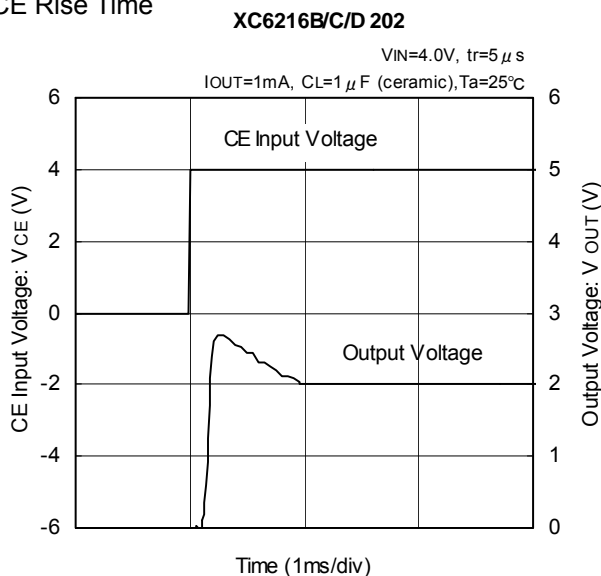

TYPICAL PERFORMANCE CHARACTERISTICS (Continued)

(9) CE Rise Time (Continued)

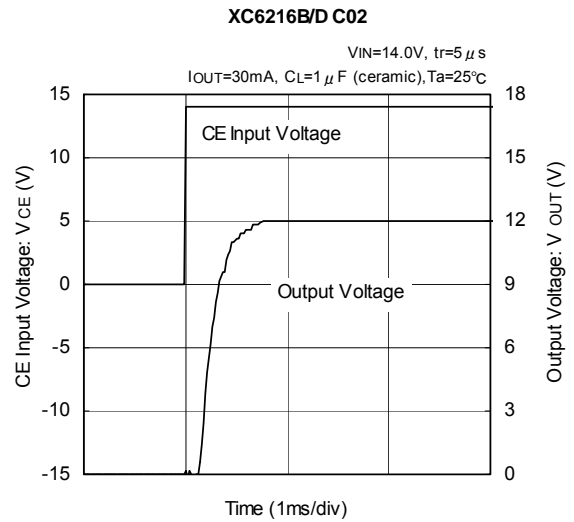
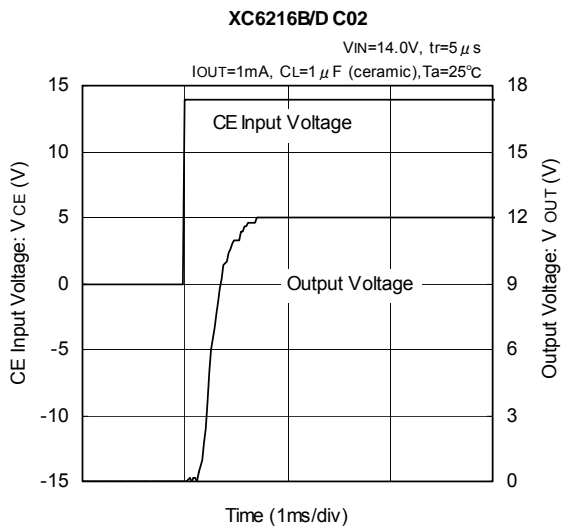
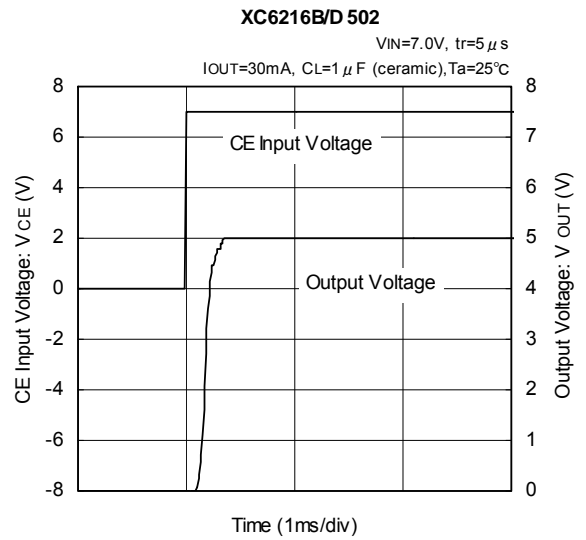
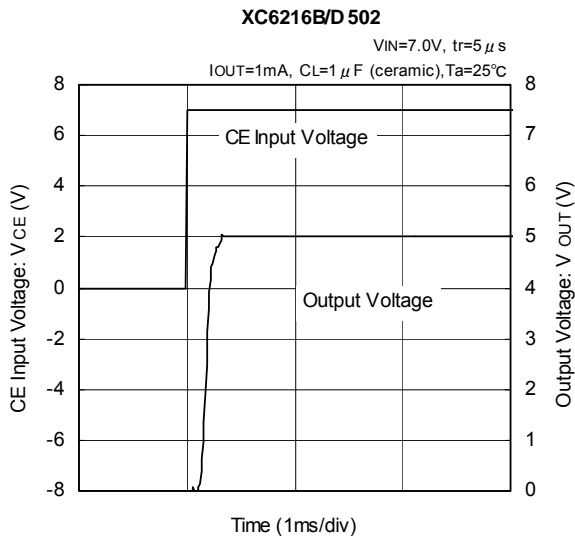
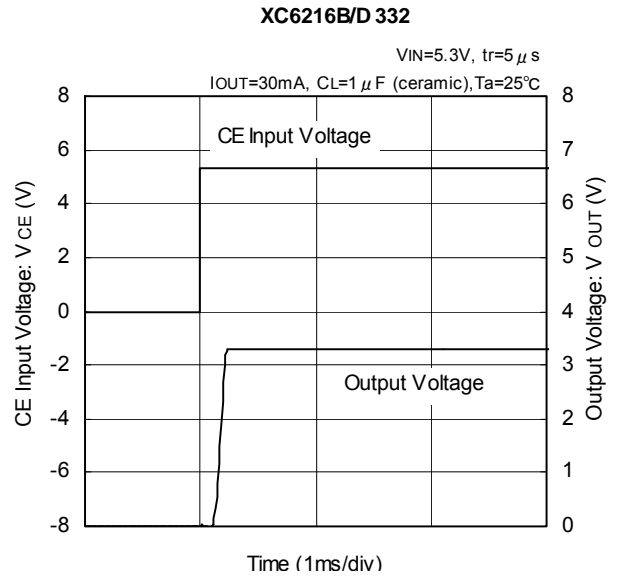
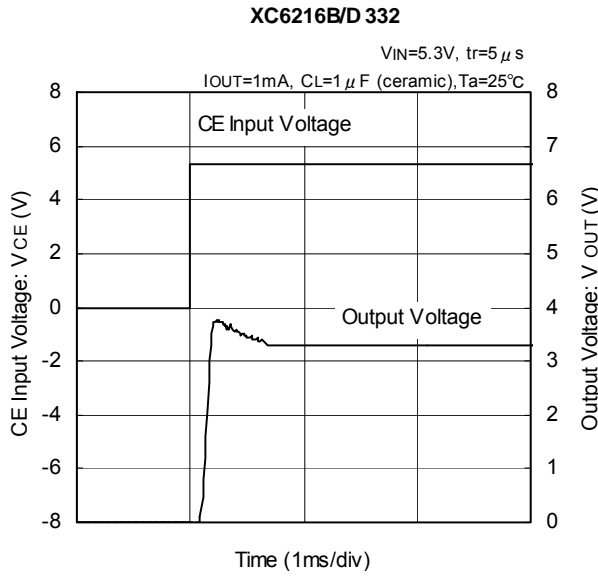

TYPICAL PERFORMANCE CHARACTERISTICS (Continued)

(10) Ripple Rejection Rate

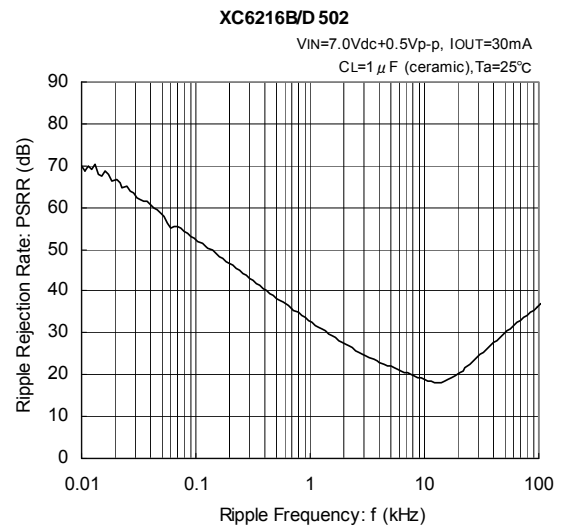
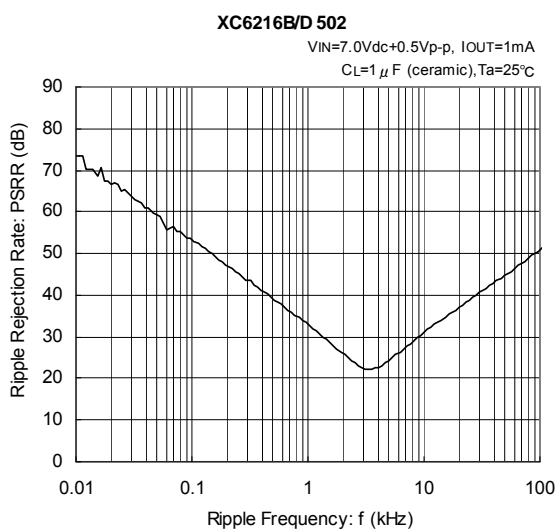
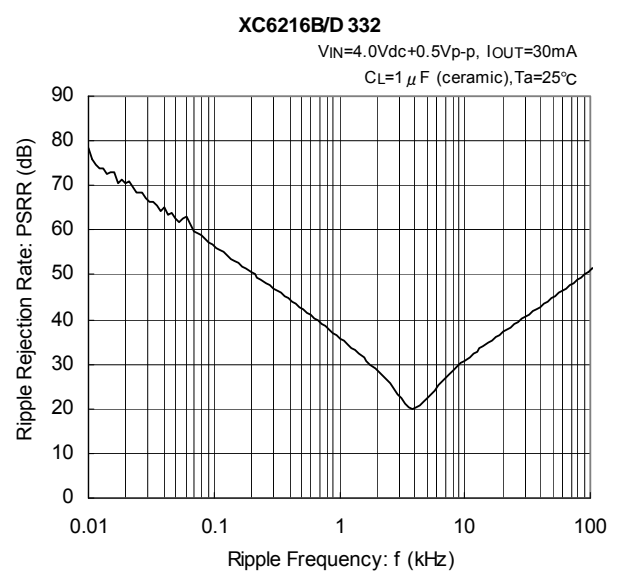
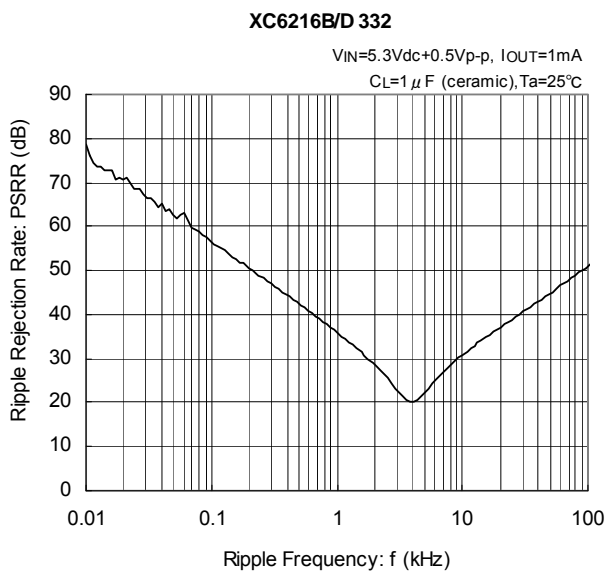
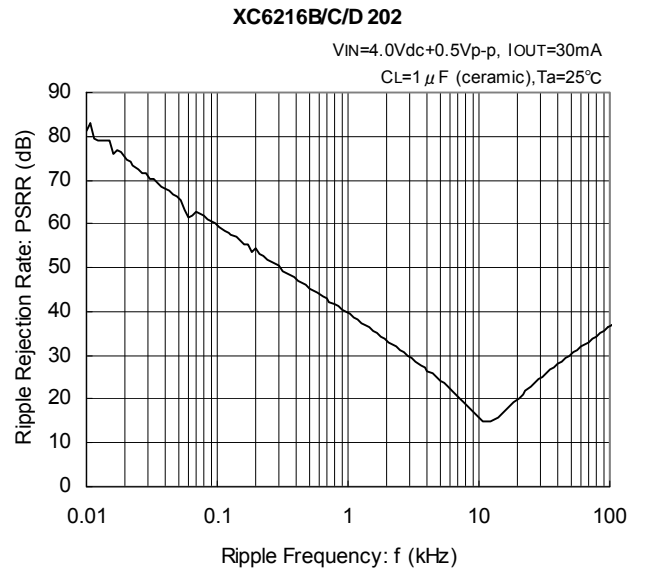
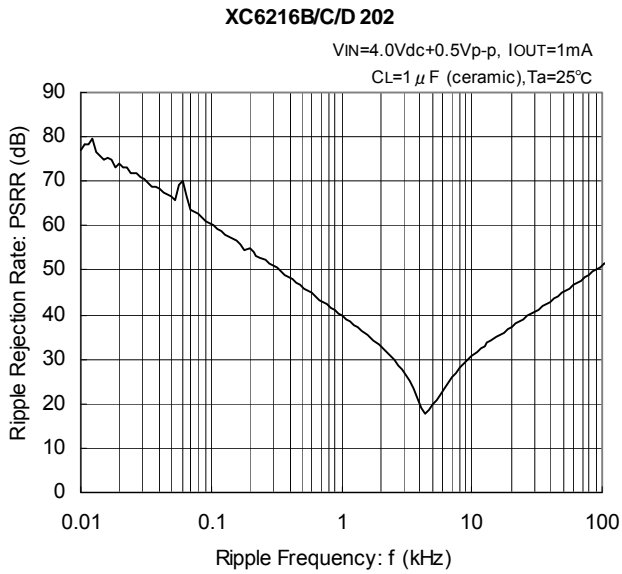

TYPICAL PERFORMANCE CHARACTERISTICS (Continued)

(10) Ripple Rejection Time (Continued)

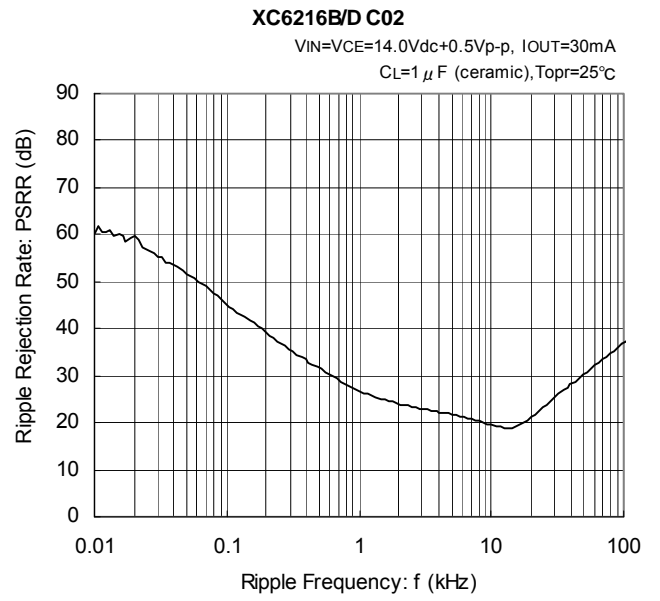
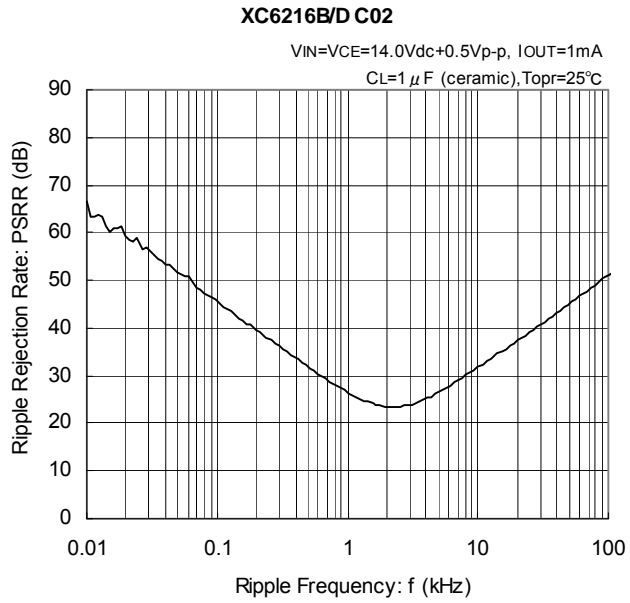

PACKAGING INFORMATION

SOT-25

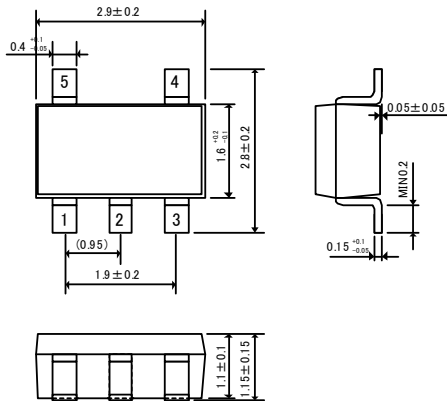

SOT-89-5

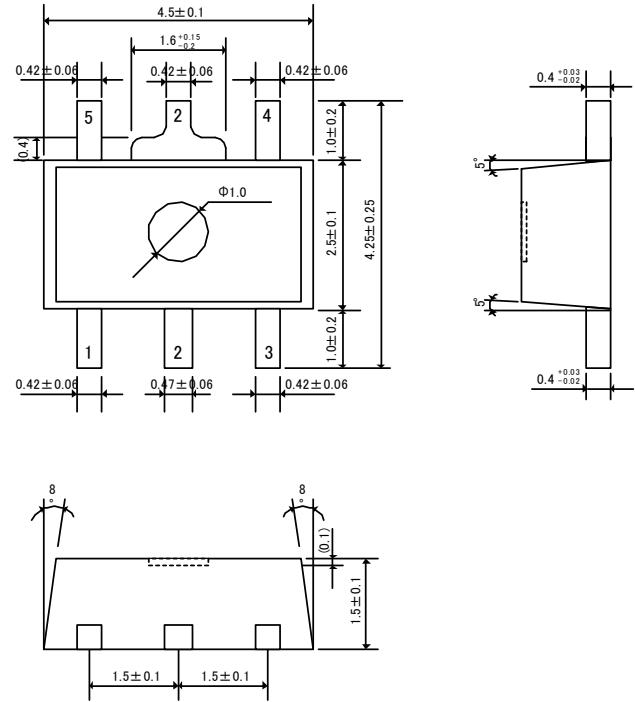

USP-6C

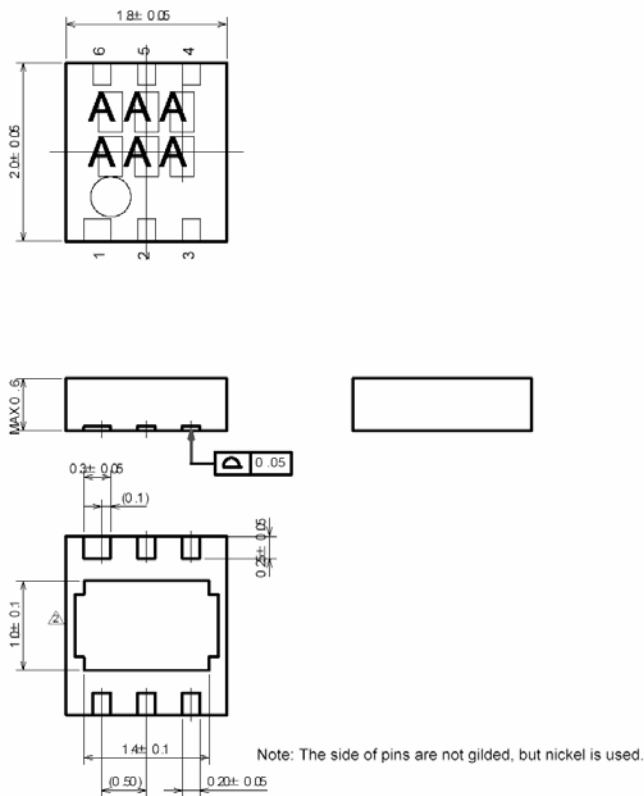

USP-6C Recommended Pattern Layout

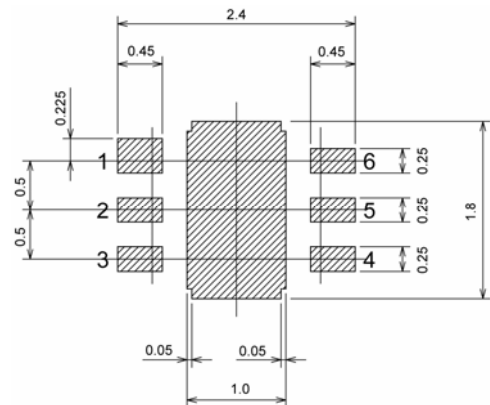

USP-6C Recommended Metal Mask Design

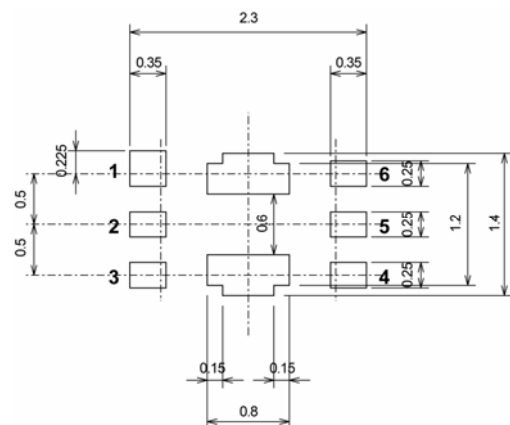

PACKAGING INFORMATION (Continued)

SOT-223

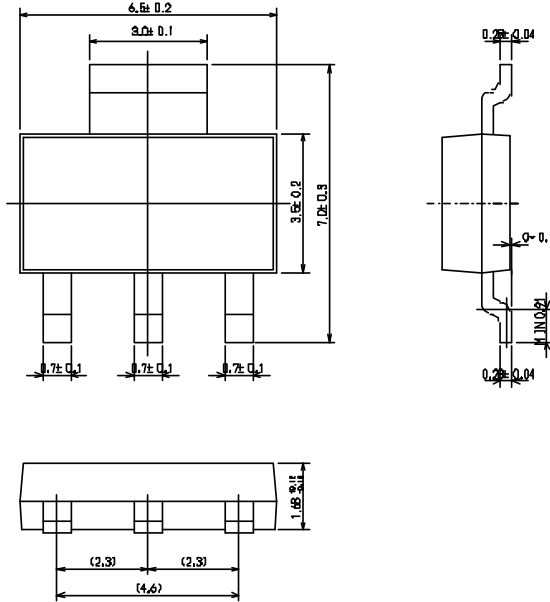

SOT-89

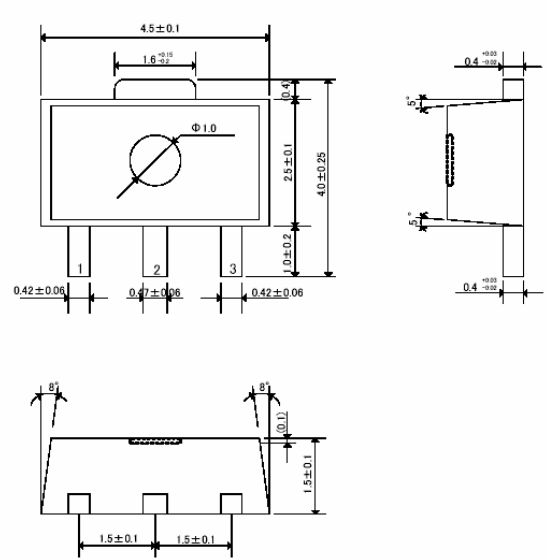

TO-252

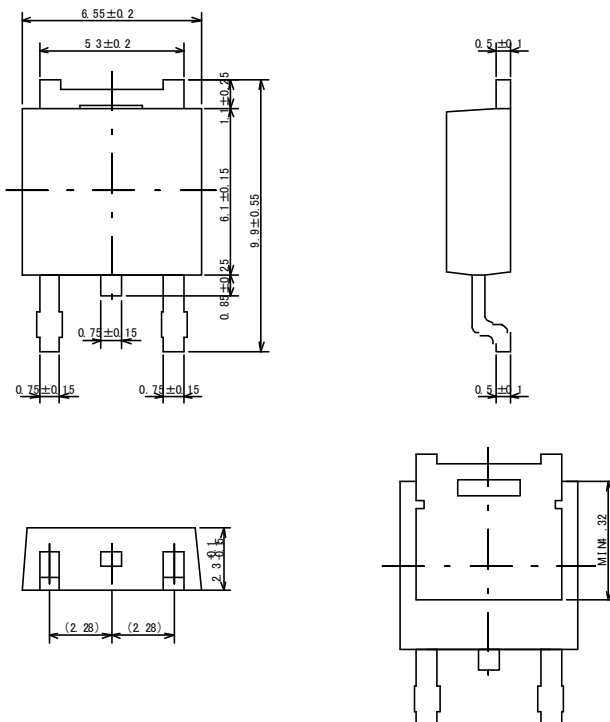

1. The products and product specifications contained herein are subject to change without notice to improve performance characteristics. Consult us, or our representatives before use, to confirm that the information in this catalog is up to date.
2. We assume no responsibility for any infringement of patents, patent rights, or other rights arising from the use of any information and circuitry in this catalog.
3. Please ensure suitable shipping controls (including fail-safe designs and aging protection) are in force for equipment employing products listed in this catalog.
4. The products in this catalog are not developed, designed, or approved for use with such equipment whose failure or malfunction can be reasonably expected to directly endanger the life of, or cause significant injury to, the user.
(e.g. Atomic energy; aerospace; transport; combustion and associated safety equipment thereof.)
5. Please use the products listed in this catalog within the specified ranges.
Should you wish to use the products under conditions exceeding the specifications, please consult us or our representatives.
6. We assume no responsibility for damage or loss due to abnormal use.
7. All rights reserved. No part of this catalog may be copied or reproduced without the prior permission of Torex Semiconductor Ltd.

TOREX SEMICONDUCTOR LTD.