

**Photologic® Slotted Optical Switch**  
**OPB615, OPB616, OPB617, OPB618 Series**  
**OPB625, OPB626, OPB627, OPB628 Series**  
**OPB665, OPB666, OPB667, OPB668 (N and T Series)**

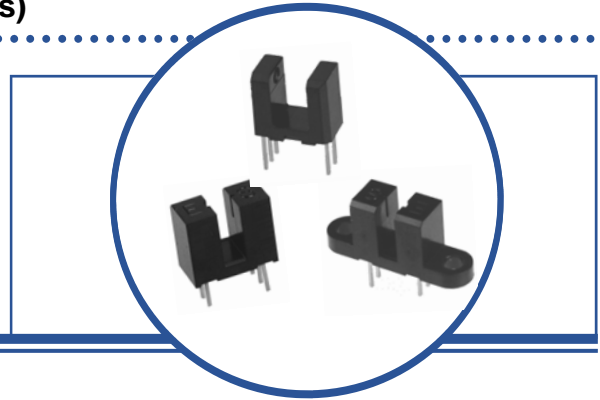

**Features:**

- Non-contact switching
- PCBoard mounting
- Enhanced signal to noise ratio
- Choice of four Logical output options



**Description:**

Each **OPB615, OPB625** and **OPB665** series slotted optical switch consists of an 890 nm, infrared Light Emitting Diode (LED) and a monolithic integrated circuit that incorporates a photodiode, a linear amplifier and a Schmitt trigger on a single silicon chip. **OPB665** offers two mounting options -- no tabs (N) or two tabs (T).

All devices in this series exhibit performance over supply voltages ranging from 4.5 V to 16.0 V, and may be specified as Buffered or Inverted with 10 kW Pull-up or Open Collector output. Devices are also TTI/LSTTL compatible and can drive up to 10 TTL loads.

Custom electrical, wire and cabling and connectors are available. Contact your local representative or OPTEK for more information.

**Applications:**

- Mechanical switch replacement
- Speed indication (tachometer)
- Mechanical limit indication
- Edge sensing

Ordering Information					
Part Number	Package Style	Sensor Photologic®	Aperture Emitter / Sensor	Slot Width / Depth	Lead Length / Spacing
OPB615	N	10K Pull-up	None	0.150" / 0.240"	0.100" (min) / 0.275"
OPB616		Open Collector			
OPB617		Inv-10K Pull-up			
OPB618		Inv-Open Collector			
OPB625		10K Pull-up	None	0.190" / 0.285"	0.100" (min) / 0.320"
OPB626		Open Collector			
OPB627		Inv-10K Pull-up			
OPB628		Inv-Open Collector			
OPB665N	10K Pull-up	0.05" / 0.01"	0.125" / 0.345"		
OPB666N	Open Collector				
OPB667N	Inv-10K Pull-Up				
OPB668N	Inv-Open Collector				
OPB665T	T		10K Pull-up	0.125" / 0.345"	
OPB666T			Open Collector		
OPB667T			Inv-10K Pull-up		
OPB668T			Inv-Open Collector		



**RoHS**

OPTEK reserves the right to make changes at any time in order to improve design and to supply the best product possible.

**Photologic® Slotted Optical Switch**  
**OPB615, OPB616, OPB617, OPB618 Series**  
**OPB625, OPB626, OPB627, OPB628 Series**  
**OPB665, OPB666, OPB667, OPB668 (N and T Series)**



**OPB 616/626/666N Buffered Open-Collector**

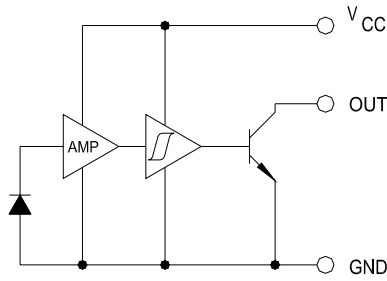

**OPB615/625/665N Buffered 10K Pull-Up**

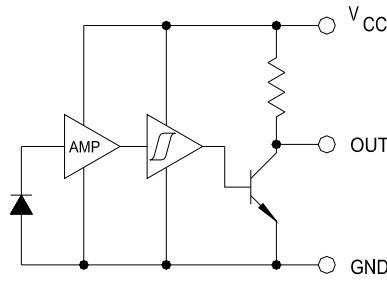

**OPB618/628/668N Inverted Open-Collector**

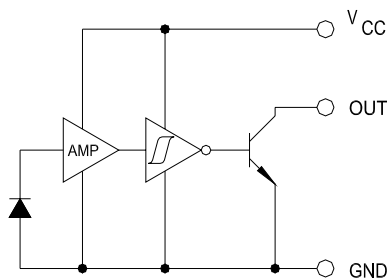

**OPB617/627/667N Inverted 10K Pull-Up**

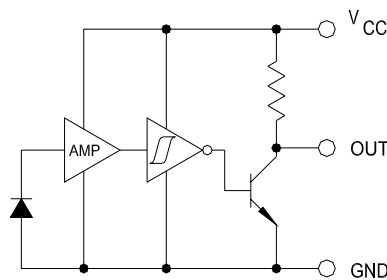

**OPB615, OPB616, OPB617, OPB618**

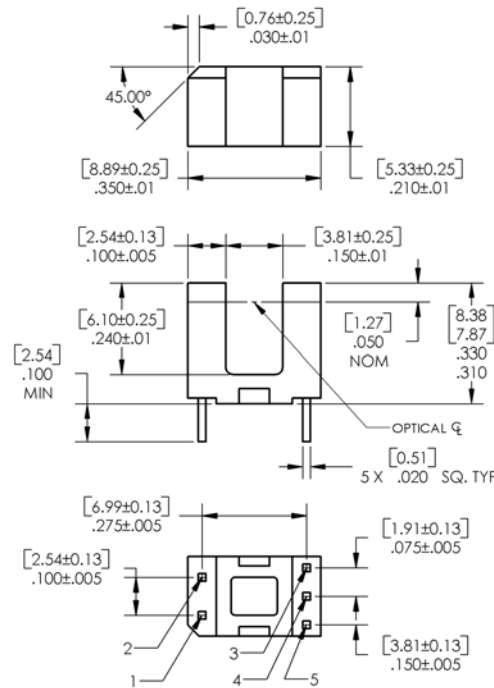

Pin Color/ Number	Description
1	Anode
2	Cathode
3	Vcc
4	Output
5	Ground

DIMENSIONS ARE IN INCHES AND [MILLIMETERS].

OPTEK reserves the right to make changes at any time in order to improve design and to supply the best product possible.

**Photologic® Slotted Optical Switch**  
**OPB615, OPB616, OPB617, OPB618 Series**  
**OPB625, OPB626, OPB627, OPB628 Series**  
**OPB665, OPB666, OPB667, OPB668 (N and T Series)**



**OPB625, OPB626, OPB627, OPB628**

Pin Color/ Number	Description
1	Anode
2	Cathode
3	Vcc
4	Output
5	Ground

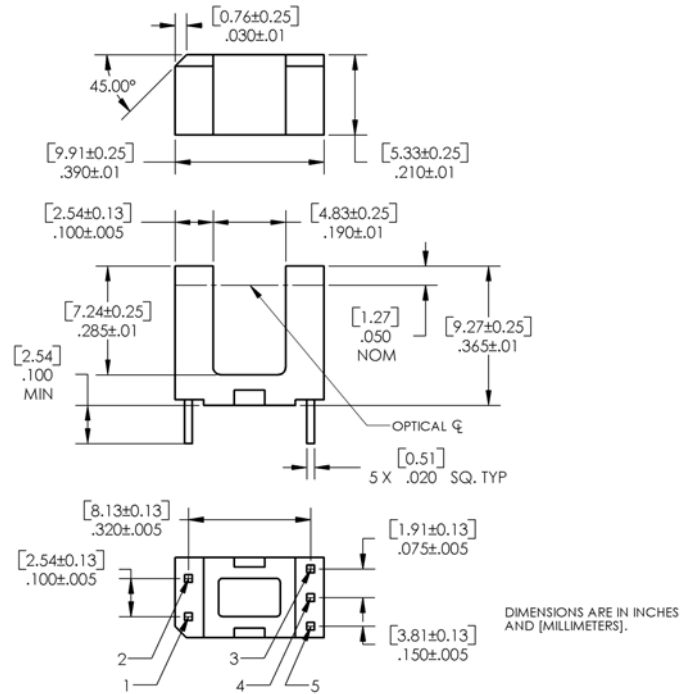

**OPB665, OPB666, OPB667, OPB668 (N and T)**

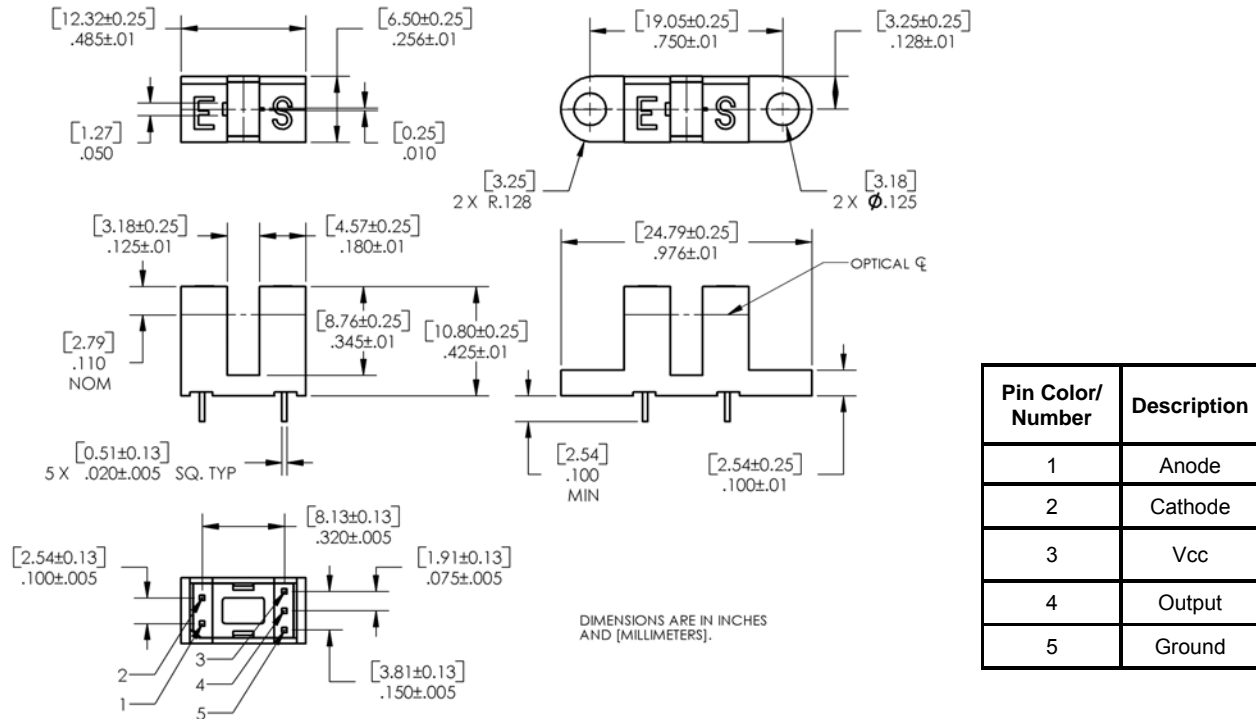

Pin Color/ Number	Description
1	Anode
2	Cathode
3	Vcc
4	Output
5	Ground

OPTEK reserves the right to make changes at any time in order to improve design and to supply the best product possible.

**Photologic® Slotted Optical Switch**  
**OPB615, OPB616, OPB617, OPB618 Series**  
**OPB625, OPB626, OPB627, OPB628 Series**  
**OPB665, OPB666, OPB667, OPB668 (N and T Series)**



**Absolute Maximum Ratings** ( $T_A=25^\circ\text{C}$  unless otherwise noted)

Storage & Operating Temperature Range	-40° C to +100° C
Lead Soldering Temperature (1/16 inch (1.6mm) from the case for 5 sec. with soldering iron) <sup>(1)</sup>	260° C

**Input Diode**

Forward DC Current	50 mA
Peak Forward Current (1 $\mu\text{s}$ pulse width, 300 pps)	3 A
Reverse DC Voltage	3 V
Power Dissipation <sup>(2)</sup>	100 mW

**Output Photologic®**

Supply Voltage, $V_{CC}$	18 V
Duration of Output Short to $V_{CC}$	1 second
Voltage at Output <sup>(5)</sup>	$V_{CC}$
Low Level Output Current (sinking)	16 mA
Power Dissipation <sup>(3)</sup>	240° mW

Notes:

- (1) RMA flux is recommended. Duration can be extended to 10 seconds maximum when flow soldering.
- (2) Derate linearly 1.33 mW/° C above 25° C.
- (3) Derate linearly 2.50 mW/° C above 25° C.
- (4) Normal application would be with light source blocked, simulated by  $I_F = 0$  mA.
- (5) Open Collector devices = 30 volts

**Electrical Characteristics** ( $T_A = 25^\circ\text{C}$  unless otherwise noted)

SYMBOL	PARAMETER	MIN	TYP	MAX	UNITS	TEST CONDITIONS
--------	-----------	-----	-----	-----	-------	-----------------

**Input Diode**

$V_F$	Forward Voltage	-	-	1.6	V	$I_F = 10$ mA
$I_R$	Reverse Current	-	-	100	$\mu\text{A}$	$V_R = 3$ V

**Output Photologic® Sensor**

$V_{CC}$	Operating DC Supply Voltage	4.5	-	16	V	
$I_{F(+)}$	LED Positive-Going Threshold Current	0.1	0.55	3	mA	$V_{CC} = 5$ V
		0.1	0.6	3		
		0.1	1.6	10		
$I_{F(+)} / I_{F(-)}$	Hysteresis	1.05	1.20	1.90		$V_{CC} = 5$ V

OPTEK reserves the right to make changes at any time in order to improve design and to supply the best product possible.

**Photologic® Slotted Optical Switch**  
**OPB615, OPB616, OPB617, OPB618 Series**  
**OPB625, OPB626, OPB627, OPB628 Series**  
**OPB665, OPB666, OPB667, OPB668 (N and T Series)**



**Electrical Characteristics** ( $T_A = 25^\circ\text{C}$  unless otherwise noted)

SYMBOL	PARAMETER	MIN	TYP	MAX	UNITS	TEST CONDITIONS	
<b>Output Photologic® Sensor</b>							
$I_{CCH}$	High Level Supply Current: Buffer, 10k Pull-up Buffer, Open-Collector	OPB615, 625, 665 OPB616, 626, 666	- -	5 5	12 12	mA mA	NO LOAD on Output <sup>(3)</sup>
	Inverted, 10k Pull-up Inverted, Open-Collector	OPB617, 627, 667 OPB618, 628, 668	- -	4 4	12 12	mA mA	NO LOAD on Output $I_F = 0$ mA
$I_{CCL}$	Low Level Supply Current: Buffer, 10k Pull-up Buffer, Open-Collector	OPB615, 625, 665 OPB616, 626, 666	- -	5.5 4.0	12 12	mA mA	NO LOAD on Output $I_F = 0$ mA
	Inverted, 10k Pull-up Inverted, Open-Collector	OPB617, 627, 667 OPB618, 628, 668	- -	6.5 5.0	12 12	mA mA	NO LOAD on Output <sup>(3)</sup>
$V_{OH}$	High Level Output Voltage: Buffer, 10k Pull-up Buffer, Open-Collector	OPB615, 625, 665 OPB616, 626, 666	$V_{CC}-1.5$ -	- -	- -	V V	$I_{OH} = 100 \mu\text{A}^{(3)}$
	Inverter, 10k Pull-up Inverter, Open-Collector	OPB617, 627, 667 OPB618, 628, 668	$V_{CC}-1.5$ -	- -	- -	V V	$I_{OH} = 100 \mu\text{A}^{(1)}$ $I_F = 0$ mA
$I_{OH}$	High Level Output Voltage: Buffer, Open-Collector	OPB616, 626, 666	-	-	100	$\mu\text{A}$	$V_{OH} = 30 \text{ V}^{(3)}$
	Inverter, Open-Collector	OPB618, 628, 668	-	-	100	$\mu\text{A}$	$I_F = 0$ mA, $V_{OH} = 30 \text{ V}^{(1)}$
$V_{OL}$	Low Level Output Voltage: Buffer, 10k Pull-up Buffer, Open-Collector	OPB615, 625, 665 OPB616, 626, 666	-	-	0.4	V	$I_{OL} = 16$ mA, $V_{CC} = 4.5 \text{ V}^{(3)(1)}$
	Inverter, 10k Pull-up Inverter, Open-Collector	OPB617, 627, 667 OPB618, 628, 668	-	-	0.4	V	$I_{OL} = 16$ mA, $I_F = 0$ mA
$t_r, t_f$	Output Rise Time, Output Fall Time		30			ns	$f = 10$ kHz, $R_L = 300 \Omega$ , DC = 50% <sup>(3)</sup>
$t_{PLH}$	Propagation Delay, Low-High Buffer, 10k Pull-up Buffer, Open-collector	OPB615, 625, 665 OPB616, 626, 666		0.6		$\mu\text{s}$	
	Inverter, 10k Pull-up Inverter, Open-Collector	OPB617, 627, 667 OPB618, 628, 668		3.0		$\mu\text{s}$	
$t_{PHL}$	Propagation Delay, High-Low Buffer, 10k Pull-up Buffer, Open-collector	OPB615, 625, 665 OPB616, 626, 666		3.0		$\mu\text{s}$	
	Inverter, 10k Pull-up Inverter, Open-Collector	OPB617, 627, 667 OPB618, 628, 668		0.6		$\mu\text{s}$	
Data Rate		-	100	-		kHz	$R_L = 300 \Omega$ , DC = 50% <sup>(4)</sup>

Notes:

- (1) Normal application would be with light source blocked, simulated by  $I_F = 0$  mA.
- (2)  $V_{OH} = V_{CC}-1.5\text{V}$  for  $V_{CC} = 4.5$  to 16 Volts.
- (3)  $I_F = 5$  mA OPB615 to OPB628;  $I_F = 10$  mA OPB665 to OPB668
- (4)  $I_F = 0$  to 5 mA OPB615 to OPB628;  $I_F = 0$  to 10 mA OPB665 to OPB668

OPTEK reserves the right to make changes at any time in order to improve design and to supply the best product possible.

**Photologic® Slotted Optical Switch**  
**OPB615, OPB616, OPB617, OPB618 Series**  
**OPB625, OPB626, OPB627, OPB628 Series**  
**OPB665, OPB666, OPB667, OPB668 (N and T Series)**



**OPB615 - Flag next to Emitter**

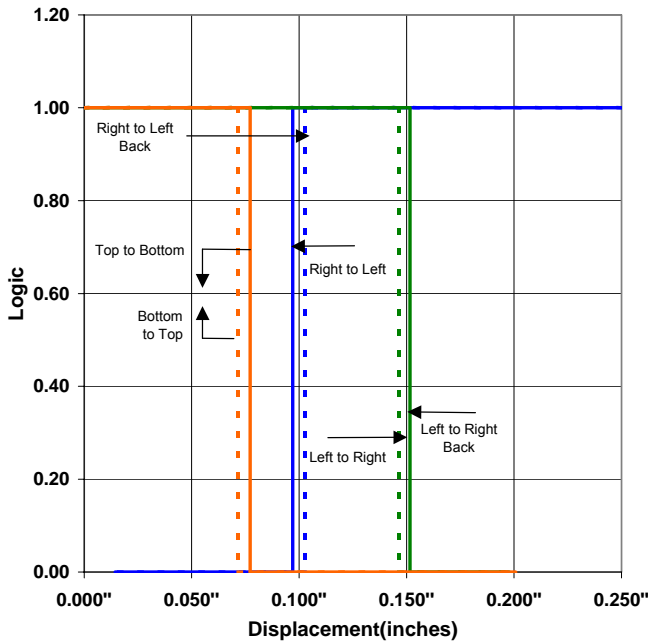

**OPB615 - Flag next to Sensor**

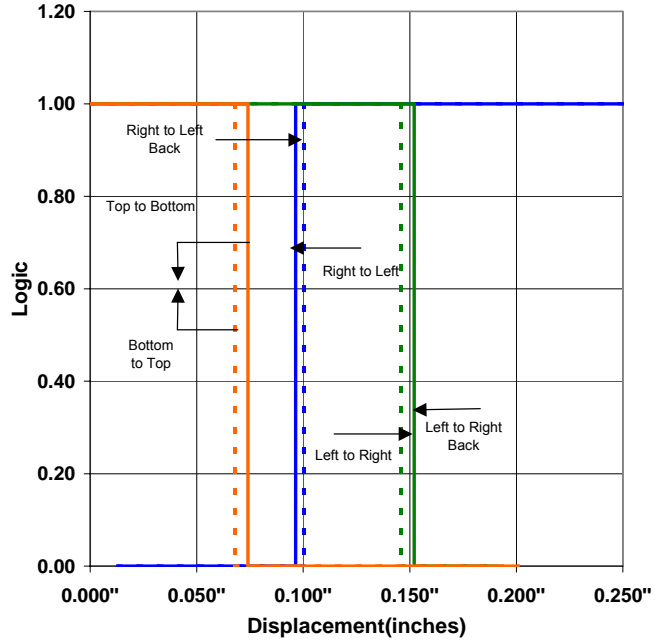

**OPB615 - Flag in Middle of Slot**

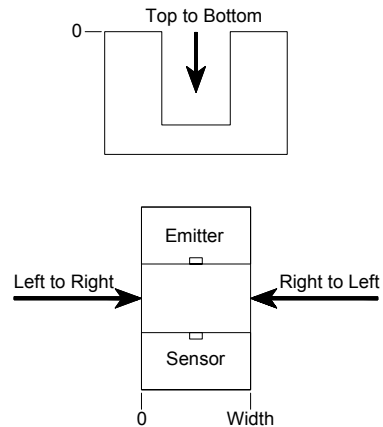
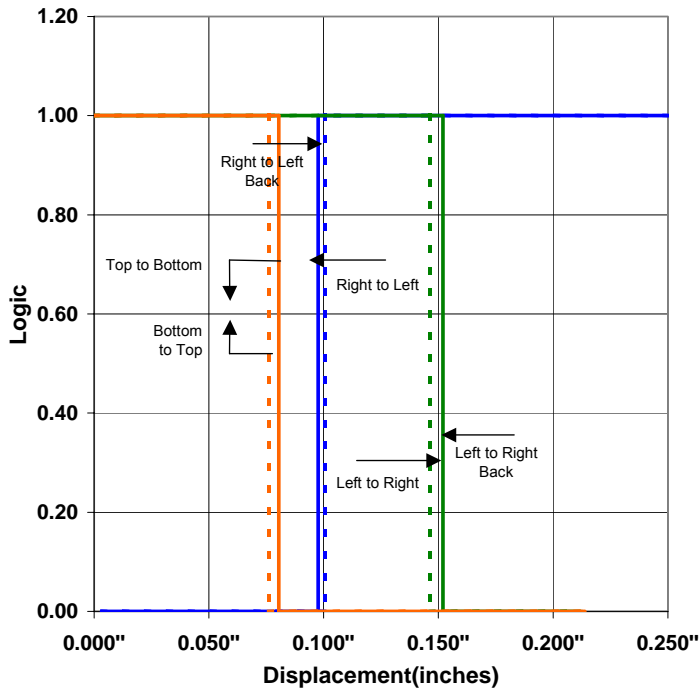

OPTEK reserves the right to make changes at any time in order to improve design and to supply the best product possible.

**Photologic® Slotted Optical Switch**  
**OPB615, OPB616, OPB617, OPB618 Series**  
**OPB625, OPB626, OPB627, OPB628 Series**  
**OPB665, OPB666, OPB667, OPB668 (N and T Series)**



**OPB625 - Flag Next to Emitter**

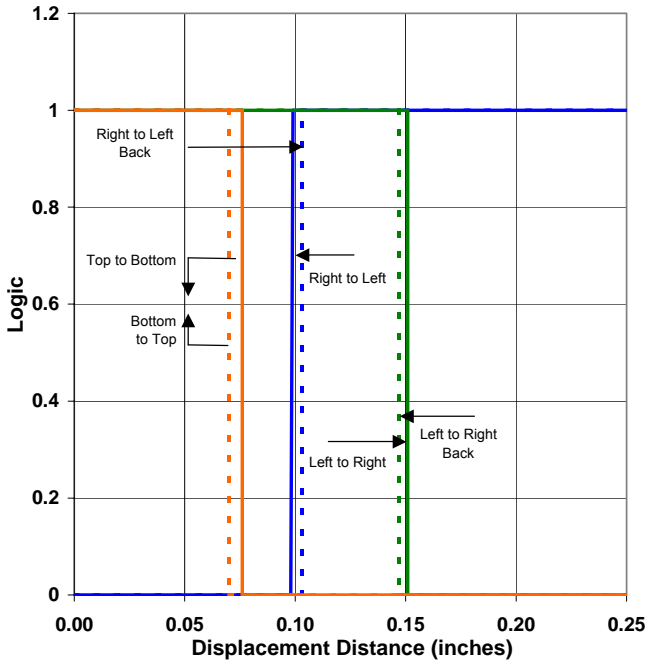

**OPB625 - Flag Next to Sensor**

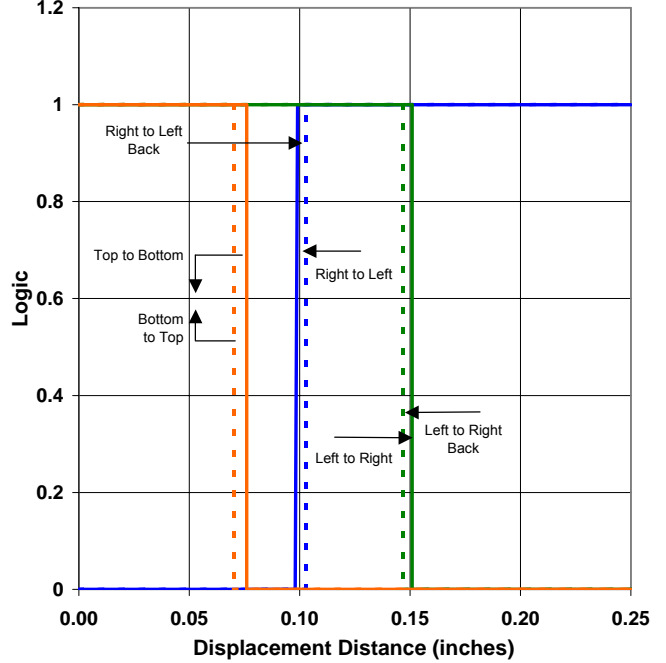

**OPB625 - Flag in Middle of Slot**

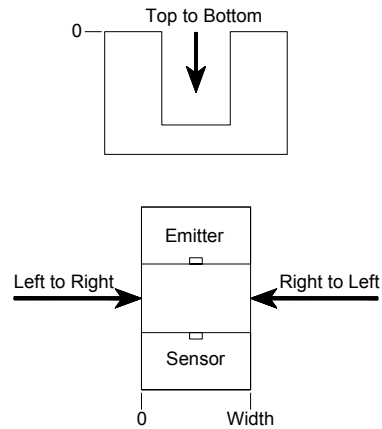
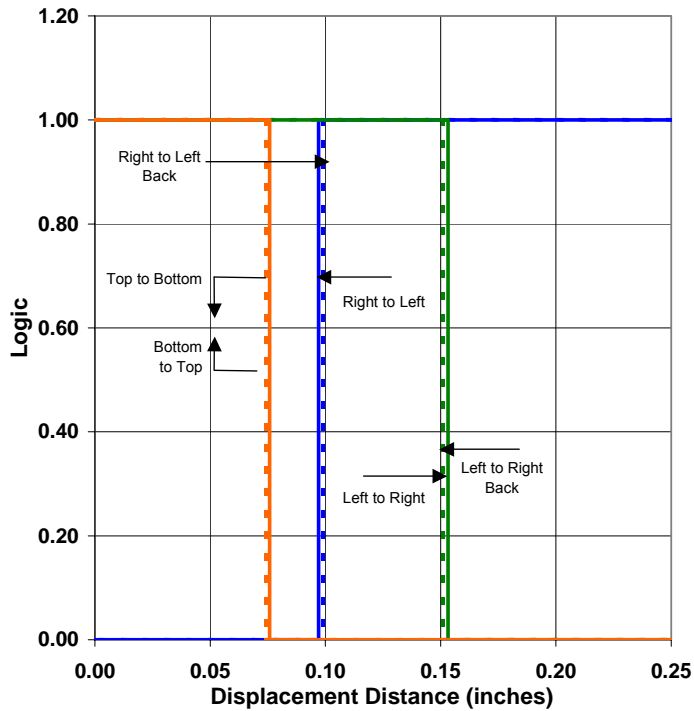

OPTEK reserves the right to make changes at any time in order to improve design and to supply the best product possible.

**Photologic® Slotted Optical Switch**  
**OPB615, OPB616, OPB617, OPB618 Series**  
**OPB625, OPB626, OPB627, OPB628 Series**  
**OPB665, OPB666, OPB667, OPB668 (N and T Series)**



**OPB665 - Flag next to Emitter**

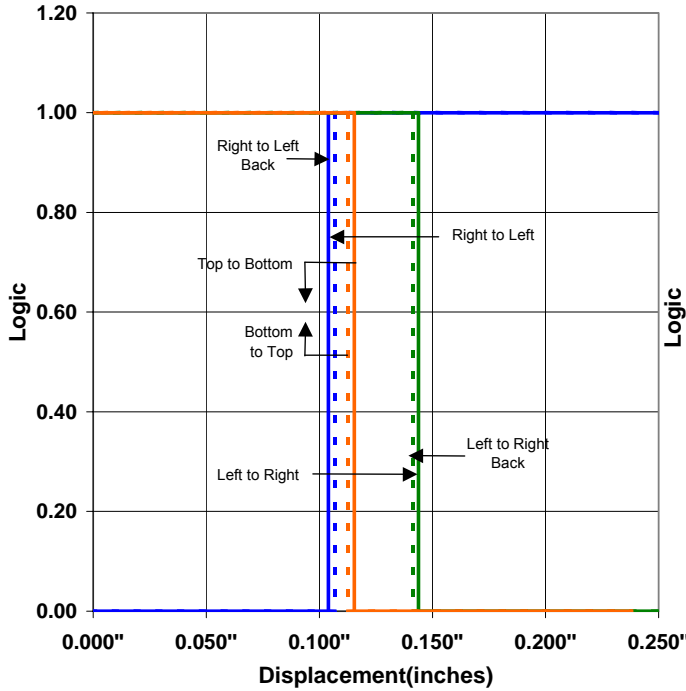

**OPB665 - Flag next to Sensor**

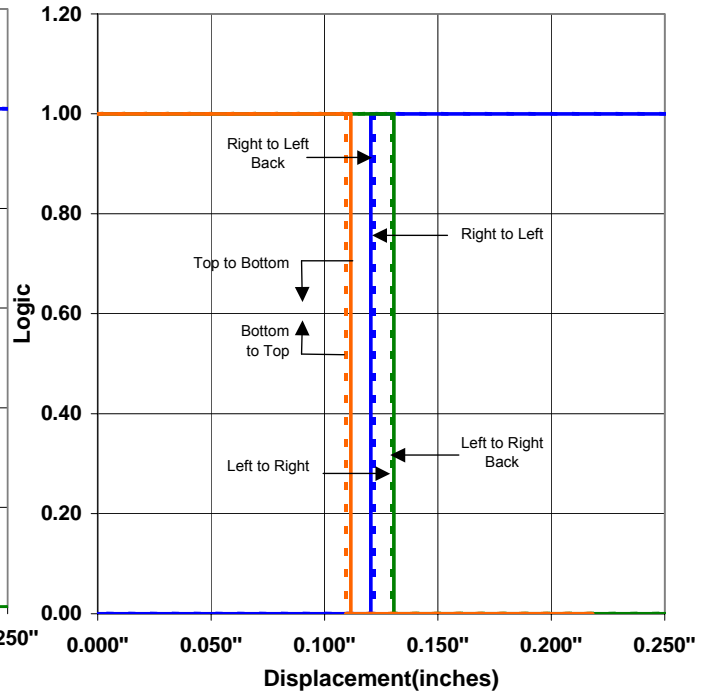

**OPB665 - Flag in Middle of Slot**

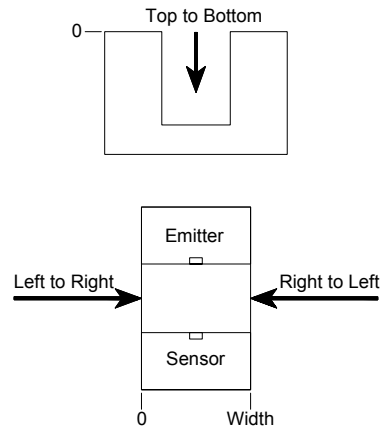
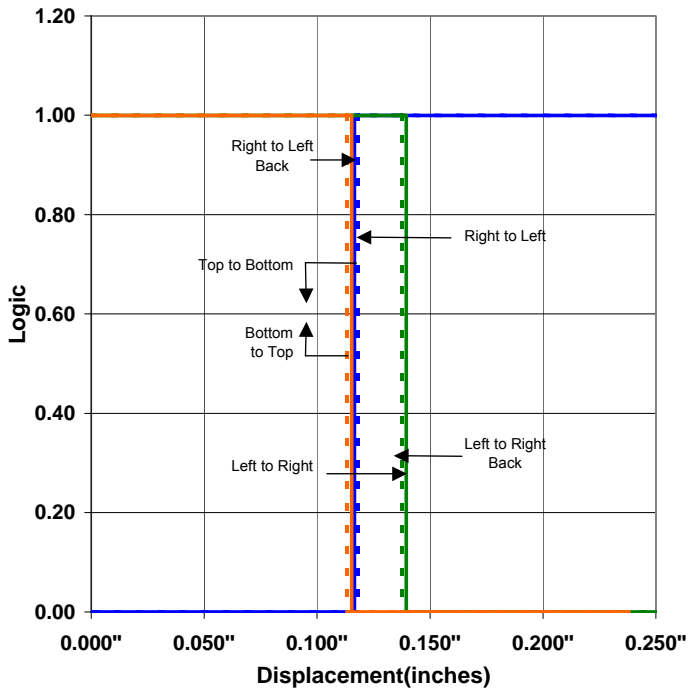

OPTEK reserves the right to make changes at any time in order to improve design and to supply the best product possible.