

Description

9007T Mill Switches

Use the 9007T Mill switches instead of other limit switches in the following applications:

- 1 Where the current load exceeds the typical heavy duty limit switch contact rating of 10 A and falls within the range of up to 20 A continuous.
- 2 Where an operating sequence is required that is not possible on other limit switches. Fifteen sequences are available. Universal type has twelve different operating sequences with CW only, CCW only and neutral position. Standard type has three operating sequences with CW and CCW operation.
- 3 Where higher reset forces are required due to foreign material interfering with lever arm operation, or where long heavy arms must reset against gravity.

9007FT Foundry Switches

The 9007FT Foundry switches are for use in foundries or mills where the applications described above are required, and where falling foundry sand or similar material could build up and jam the operating mechanism. The shaft has a dust boot and extends from the switch case, preventing sand build up around the shaft. The devices can withstand hot falling sand up to 300° F (149° C).

9007 (convertible sequence)

9007T Mill Switches

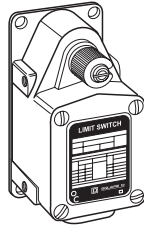

Pages 8 and 9

9007FT Foundry Switches

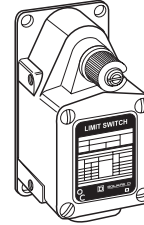

Pages 10 and 11

Application Information

Type T — Ideal for applications requiring extra heavy duty contact ratings, or higher operating and reset forces. Rugged mechanical construction with several different operating sequences in one basic switch.

Type FT — Designed specifically for rough foundry application. The shaft is entirely beyond the switch case to prevent jamming of the lever arm due to build up of sand. A dust boot is furnished as standard to further prevent sand packing and allow free movement of the lever arm. An extra long shaft bearing makes the switch extremely rugged and able to handle the rough applications encountered in foundries, mills, machine tool and similar industries. The switch will withstand hot falling sand up to 300° F (149° C).

Type T and FT

Enclosure — Oil-tight, dust-tight, water-tight, drip-tight meets NEMA 2, 4, and 13 requirements. Die cast zinc construction.

Operating Sequences — Fifteen sequences available. Universal type has 12 different operating sequences with CW only, CCW only, and neutral position operation. Standard type has three operating sequences with CW and CCW operation. Various sequences will give quick make and break, spring return with maintained contact, or slow make and break. Most sequences are convertible by removing the base plate and adjusting the positioning plate and/or latches

Ambient Temperature Range — 10° F (-12.2° C) to 185° F (85° C) ambient at full rated load, up to 220° F (104° C) ambient with single coil load.

Lever Arm — Die cast zinc construction with hardened, oil-impregnated, sintered iron rollers.

Conduit — 0.5" standard / 20 mm optional - Form M11

Mounting — Four baseplates provide end or side mounting holes and/or manifold mounting. All mounting holes are 0.25" (6.35 mm) diameter. Two tapped holes on each side of switch allows side mounting.

Contacts — SPDT, double break and three point double throw single break. Silver contact tips. Phenolic contact block. Nylon liner. Polarity must be same on double throw contacts.

Environment characteristics

Conforming to standards	UL508
Product certifications	UL Listed, CSA Certified, CE Marked
Protective treatment	Corrosion resistant gray paint
Ambient air temperature	- 10 °F to + 185 °F (-23 °C to + 85 °C)
Vibration resistance	10G (10 - 55 Hz)
Shock resistance	30G
Electric shock protection	Class O
Degree of protection	NEMA Type 1, 2, 4, 12, 13, IP65, 66, 67
Cable entry or connector	0.5" NPT (metric available)
Materials	Cast zinc ◊

Contact block characteristics

Rated operational characteristics hard contacts	AC Voltage	NEMA A600 Ithe = 20 A 20 A Resistive and continuous
Rated operational characteristics hard contacts	DC Voltage	NEMA P 600 Ithe = 20 A 20 A Resistive and continuous
Rated insulation voltage		600 V
Rated impulse withstand voltage		2,500 Vac for 1 minute for CE, 2,200 Vac for 1 minute for UL, and 2,640 Vac for 1 minute for CSA
Positive opening		No
Short circuit protection		20 A Bussmann Class CC KTK-R-20 fuse, non time delay
Terminal wire sizes (Cabling/Screw Clamp)		12 – 22 AWG (3.31 mm ² – 0.326 mm ²) wire max.
Maximum actuation speed		15.2 fpm / 27.4 fpm (50 fpm / 90 fpm) with 45 ° Cam angle, levers only
Electrical durability		N/A (future availability)

Maximum current ratings for control circuit contacts

Contacts	Volts	AC							Volts	DC		
		Inductive 35% Power Factor				Con- tinuous Carrying Amperes	Resistive 75% Power Factor			Inductive and Resistive		
		Make		Break			Make, Break and Continuous Carrying Amperes	Make and Break Amperes		Con- tinuous Carrying Amperes		
		Amperes	VA	Amperes	VA			Single Throw			Double Throw	
SPDT Quick Make and Break	120	150	18,000	20	2400	20	20	120	5.0	⊕	20	
	240	75	18,000	12.5	3000	20	20	250	1.0	⊕	20	
	480	37.5	18,000	6.25	3000	20	20	600	0.2	⊕	20	
	600	30	18,000	5	3000	20	20					
All Slow Make and Break	120	60	7200	6	720	20	10	20	
	240	30	7200	3	720	20	10	20	
	480	15	7200	1.5	720	20	10	20	
	600	12	7200	1.2	720	20	10	20	

Characteristics for material and ratings comparisons — standard switches ◊

	9007 Type T/FT	Type L (R. B. Denison Lox Switch)
Body material	Cast zinc	Cast aluminum
Cover material	Cast zinc	Aluminum
Base plate material	Steel with zinc plating	Steel with chromate plating
Shaft seal material	Nitrile	PVC
Contact block material	Phenolic	Glass filled nylon
Moveable contact material	Fine silver on copper backing	Coin Silver on steel backing
Stationary contact material	Fine silver on copper backing	90/10 AgCdO on copper backing
Low ambient temperature rating	-10° F	0° F
High ambient temperature at full rating ◊	180° F	200° F
Enclosure rating	NEMA Types 1, 2, 4, 12 and 13	NEMA Types 1, 4 and 13
Vibration resistance	10G (10 - 150 Hz)	40G max (10-150 Hz)

















◊ Many switches are available with higher or lower temperature limits by selecting special versions or special options. See page 29.

Severe Duty Limit Switches

9007T Mill Switches

Universal operating sequences

Universal References







Base Plate						
Surface Mounted	A 9007TUA1 B 9007TUB1 C 9007TUC1 D 9007TUD1	9007TUA2 9007TUB2 9007TUC2 9007TUD2	9007TUA3 9007TUB3 9007TUC3 9007TUD3	9007TUA4 9007TUB4 9007TUC4 9007TUD4	9007TUA5 9007TUB5 9007TUC5 9007TUD5	9007TUA6 9007TUB6 9007TUC6 9007TUD6
	No. 1 Single Pole Double Throw Spring Return CW Only	No. 2 Single Pole Double Throw Spring Return CW Only	No. 3 ④ Single Pole Double Throw Maintained Contact	No. 4 Single Pole Double Throw Spring Return Neutral Position	No. 5 Single Pole Double Throw Spring Return CCW Only	No. 6 Single Pole Double Throw Spring Return CCW Only
	Initial position and CCW  CW 	Initial position and CCW  Middle CW  Final CW 	Spring return of arm to initial pos. Contact pos. maintained until operated in reverse direction CCW  CW  If high speed cam or snap-back is present, use No. 12	Initial position  CCW  CW 	Initial position and CW  CCW 	Initial position and CW  Middle CCW  Final CCW 

Characteristics















Nominal Operating Data

Pre-travel ①	14°	Int. Pos. 9°, Final 16°	7°	6°	14°	Int. Pos. 9°, Final 16°
Total travel	88°	88°	81°	81°	88°	88°
Differential	12°	5°	7°	5°	12°	5°
Operating torque	12 lb-in (1.35 N•m)	12 lb-in (1.35 N•m)	12 lb-in (1.35 N•m)	12 lb-in (1.35 N•m)	12 lb-in (1.35 N•m)	12 lb-in (1.35 N•m)
Repeat accuracy ②	± 0.004" (0.10mm)	± 0.004" (0.10mm)	± 0.004" (0.10mm)	± 0.004" (0.10mm)	± 0.004" (0.10mm)	± 0.004" (0.10mm)

To convert sequences, remove base plate, position plate and latches. Reassemble positioning plate and latches as shown.

						
Weight lb (kg)	2.35 lb. (0.18 kg)	2.35 lb. (0.18 kg)	2.35 lb. (0.18 kg)	2.35 lb. (0.18 kg)	2.35 lb. (0.18 kg)	2.35 lb. (0.18 kg)

Universal References (continued)





Base Plate						
Surface Mounted	A 9007TUA7 B 9007TUB7 C 9007TUC7 D 9007TUD7	9007TUA8 9007TUB8 9007TUC8 9007TUD8	9007TUA9 9007TUB9 9007TUC9 9007TUD9	9007TUA10 9007TUB10 9007TUC10 9007TUD10	9007TUA11 9007TUB11 9007TUC11 9007TUD11	9007TUA12 9007TUB12 9007TUC12 9007TUD12
	No. 7 Single Pole Double Throw Maintained	No. 8 ④ Single Pole Double Throw Maintained Neutral Position	No. 9 Single Pole Double Throw Spring Return Slow Make Slow Break	No. 10 Single Pole Double Throw Spring Return Slow Make Slow Break	No. 11 Single Pole Double Throw Spring Return Slow Make Slow Break	No. 12 Single Pole Double Throw Maintained
	If high speed cam or snap-back present, use No. 12  CCW 	Initial position If high speed cam or snap-back is present, use No. 12  CCW  CW 	Initial position and CCW  CW 	Initial position  CCW  CW 	Initial position and CW  CCW 	CCW  CW 

Characteristics

Nominal Operating Data







Pre-travel ①	10°	6°	12°	3°	12°	45°
Total travel	85°	81°	87°	81°	87°	90°
Differential	12°	10°	0°	0°	0°	0°
Operating torque	2.5 lb-in (0.28 N•m)	2.5 lb-in (0.28 N•m)	12 lb-in (1.35 N•m)	12 lb-in (1.35 N•m)	12 lb-in (1.35 N•m)	8 lb-in (0.9 N•m)
Repeat accuracy ②	± 0.004" (0.10mm)	± 0.004" (0.10mm)	± 0.004" (0.10mm)	± 0.004" (0.10mm)	± 0.004" (0.10mm)	± 0.004" (0.10mm)

To convert sequences, remove base plate, position plate and latches. Reassemble positioning plate and latches as shown.

						Not adjustable
Weight lb (kg)	2.35 lb (0.18 kg)	2.35 lb. (0.18 kg)	2.35 lb. (0.18 kg)	2.35 lb. (0.18 kg)	2.35 lb. (0.18 kg)	2.35 lb. (0.18 kg)

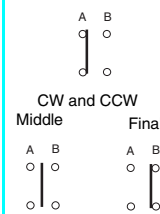
Standard References

Base Plate

Surface Mounted	A B C D	9007TSA1 9007TSB1 9007TSC1 9007TSD1	9007TSA2 9007TSB2 9007TSC2 9007TSD2	9007TSA3 9007TSB3 9007TSC3 9007TSD3
		No. 1 Single Pole Double Throw Spring Return CW & CCW	No. 2 Single Pole Double Throw Spring Return CW & CCW	No. 3 Single Pole Double Throw Spring Return CW & CCW Slow Make Slow Break
		Initial position 	Initial position 	Initial position 
		CW and CCW 	CW and CCW Middle Final 	CW and CCW 

Characteristics (nominal operating data)

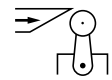
Switch actuation	By 30° cam		
Type of actuation			
Pre-travel ①	14°	Int. Pos. 9°, Final 16°	9°
Total travel	89°	89°	89°
Differential	12°	Int. Pos. 5.5°, Final 7.5°	5°
Reverse overtravel	N/A (future availability)	N/A (future availability)	N/A (future availability)
Mechanical durability in millions of operating cycles	N/A (future availability)	N/A (future availability)	N/A (future availability)
Operating torque/force 1 pole & 2 pole	10 lb-in (1.13 N•m)	10 lb-in (1.13 N•m)	10 lb-in (1.13 N•m)
Terminal wire sizes (Cabling/Screw Clamp)	#12 - 22 AWG (3.31 mm ² - 0.326 mm ²)	#12 - 22 AWG (3.31 mm ² - 0.326 mm ²)	#12 - 22 AWG (3.31 mm ² - 0.326 mm ²)
Repeatability ② (linear travel of cam)	± 0.004" (0.10mm)	± 0.004" (0.10mm)	± 0.004" (0.10mm)
Cable entry (metric available)	0.5" NPT	0.5" NPT	0.5" NPT
Weight lb (kg)	2.35 lb. (0.18 kg)	2.35 lb. (0.18 kg)	2.35 lb. (0.18 kg)

① The pre-travel listed may vary up to 5° additional for universal switches or up to 2° additional for standard switches due to free travel of lever arm at initial position.

② Linear travel of cam on 1.5" (38.1mm) lever arm.

③ Remove spring from the positioning plate.

④ Sequence 3, 7, and 8 devices are available but are not recommended where high speed cams or lever arm snap-back is present.











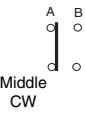

The application should be checked and No. 12 sequences substituted where possible.

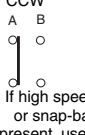
Note: Type FT Foundry Switches are obtained by changing the "T" at the beginning of the equivalent type number above to "FT" (Example: FTUB1).

See pages 10 and 11.

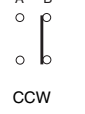
Universal References

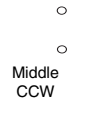
Base Plate







Surface Mounted	A 9007FTUA1 9007FTUB1 9007FTUC1 9007FTUD1	9007FTUA2 9007FTUB2 9007FTUC2 9007FTUD2	9007FTUA3 9007FTUB3 9007FTUC3 9007FTUD3	9007FTUA4 9007FTUB4 9007FTUC4 9007FTUD4	9007FTUA5 9007FTUB5 9007FTUC5 9007FTUD5	9007FTUA6 9007FTUB6 9007FTUC6 9007FTUD6
	No. 1 Single Pole Double Throw Spring Return CW Only	No. 2 Single Pole Double Throw Spring Return CW Only	No. 3 ④ Single Pole Double Throw Maintained Contact	No. 4 Single Pole Double Throw Spring Return Neutral Position	No. 5 Single Pole Double Throw Spring Return CCW Only	No. 6 Single Pole Double Throw Spring Return CCW Only
	Initial position and CCW  CW 	Initial position and CCW  Middle CW  Final CW 	Spring return of arm to initial pos. Contact pos. maintained until operated in reverse direction CCW  CW  If high speed cam or snap-back is present, use No. 12	Initial position  CCW  CW 	Initial position and CW  CCW 	Initial position and CW  Middle CCW  Final CCW 

Characteristics

Nominal Operating Data









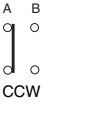

Pre-travel ①	14°	Int. Pos. 9°, Final 16°	7°	6°	14°	Int. Pos. 9°, Final 16°
Total travel	88°	88°	81°	81°	88°	88°
Differential	12°	5°	7°	5°	12°	5°
Operating torque	12 lb-in (1.35 N•m)	12 lb-in (1.35 N•m)	12 lb-in (1.35 N•m)	12 lb-in (1.35 N•m)	12 lb-in (1.35 N•m)	12 lb-in (1.35 N•m)
Repeat accuracy ②	± 0.004" (0.10mm)	± 0.004" (0.10mm)	± 0.004" (0.10mm)	± 0.004" (0.10mm)	± 0.004" (0.10mm)	± 0.004" (0.10mm)

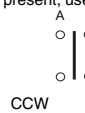
To convert sequences, remove base plate, position plate and latches. Reassemble positioning plate and latches as shown.

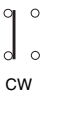
						
Weight lb (kg)	2.57 lb (0.96 kg)	2.57 lb (0.96 kg)	2.57 lb (0.96 kg)	2.57 lb (0.96 kg)	2.57 lb (0.96 kg)	2.57 lb (0.96 kg)

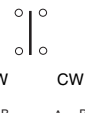
Universal References (continued)

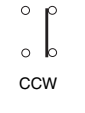
Base Plate

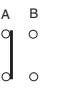



Surface Mounted	A 9007FTUA7 9007FTUB7 9007FTUC7 9007FTUD7	9007FTUA8 9007FTUB8 9007FTUC8 9007FTUD8	9007FTUA9 9007FTUB9 9007FTUC9 9007FTUD9	9007FTUA10 9007FTUB10 9007FTUC10 9007FTUD10	9007FTUA11 9007FTUB11 9007FTUC11 9007FTUD11	9007FTUA12 9007FTUB12 9007FTUC12 9007FTUD12
	No. 7 Single Pole Double Throw Maintained	No. 8 ④ Single Pole Double Throw Maintained Neutral Position	No. 9 Single Pole Double Throw Spring Return Slow Make Slow Break	No. 10 Single Pole Double Throw Spring Return Slow Make Slow Break	No. 11 Single Pole Double Throw Spring Return Slow Make Slow Break	No. 12 Single Pole Double Throw Maintained
	If high speed cam or snap-back present, use No. 12  CCW 	Initial position If high speed cam or snap-back present, use No. 12  CCW  CW 	Initial position and CCW  CW 	Initial position  CCW  CW 	Initial position and CW  CCW 	CCW  CW 

Characteristics





Nominal Operating Data

Pre-travel ①	10°	6°	12°	3°	12°	45°
Total travel	85°	81°	87°	81°	87°	90°
Differential	12°	10°	0°	0°	0°	0°
Operating torque	2.5 lb-in (0.28 N•m)	2.5 lb-in (0.28 N•m)	12 lb-in (1.35 N•m)	12 lb-in (1.35 N•m)	12 lb-in (1.35 N•m)	8 lb-in (0.9 N•m)
Repeat accuracy ②	± 0.004" (0.10mm)	± 0.004" (0.10mm)	± 0.004" (0.10mm)	± 0.004" (0.10mm)	± 0.004" (0.10mm)	± 0.004" (0.10mm)

To convert sequences, remove base plate, position plate and latches. Reassemble positioning plate and latches as shown.

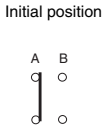
						Not adjustable
Weight lb (kg)	2.57 lb (0.96 kg)	2.57 lb (0.96 kg)	2.57 lb (0.96 kg)	2.57 lb (0.96 kg)	2.57 lb (0.96 kg)	2.57 lb (0.96 kg)

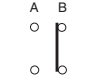
Standard References

Base Plate				
Surface Mounted	A B C D	9007FTSA1 9007FTSB1 9007FTSC1 9007FTSD1	9007FTSA2 9007FTSB2 9007FTSC2 9007FTSD2	9007FTSA3 9007FTSB3 9007FTSC3 9007FTSD3
		No. 1 Single Pole Double Throw Spring Return CW & CCW Initial position  CW and CCW 	No. 2 Single Pole Double Throw Spring Return CW & CCW Initial position  CW and CCW Middle Final 	No. 3 Single Pole Double Throw Spring Return CW & CCW Slow Make Slow Break Initial position  CW and CCW 

Characteristics (nominal operating data)

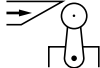
Switch actuation	By 30° cam		
Type of actuation			
Pre-travel ①	14°	Int. Pos. 9°, Final 16°	9°
Total travel	89°	89°	89°
Differential	12°	Int. Pos. 5.5°, Final 7.5°	5°
Reverse overtravel	N/A (future availability)	N/A (future availability)	N/A (future availability)
Mechanical durability (in millions of operating cycles)	N/A (future availability)	N/A (future availability)	N/A (future availability)
Operating torque/force 1 pole & 2 pole	10 lb-in (1.13 N•m)	10 lb-in (1.13 N•m)	10 lb-in (1.13 N•m)
Terminal wire sizes (Cabling/Screw Clamp)	#12 - 22 AWG (3.31 mm ² - 0.326 mm ²)	#12 - 22 AWG (3.31 mm ² - 0.326 mm ²)	#12 - 22 AWG (3.31 mm ² - 0.326 mm ²)
Repeatability ② (linear travel of cam)	± 0.004" (0.10mm)	± 0.004" (0.10mm)	± 0.004" (0.10mm)
Cable entry (metric available)	0.5" NPT	0.5" NPT	0.5" NPT
Weight lb (kg)	2.57 lb. (0.96 kg)	2.57 lb. (0.96 kg)	2.57 lb. (0.96 kg)

① The pre-travel listed may vary up to 5° additional for universal switches or up to 2° additional for standard switches due to free travel of lever arm at initial position.

② Linear travel of cam on 1.5" (38.1mm) lever arm.

③ Remove spring from the positioning plate.

④ Sequence 3, 7, and 8 devices are available but are not recommended where high speed cams or lever arm snap-back is present.

The application should be checked and No. 12 sequences substituted where possible.

Note: Type FT Foundry Switches are obtained by changing the "T" at the beginning of the equivalent type number to "FT" (Example: FTUB1).

Severe Duty Limit Switches

9007 Mill and Foundry Switches

Lever Arms for 9007T and FT

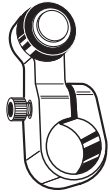

Standard Roller

Standard Roller					
Arm	Steel roller	Roller Position	Reference	Weight	
Length Inches (mm)	Diameter Inches (mm)	Width Inches (mm)		lb (kg)	
1.5 (38.1)	0.75 (19)	Optional	0.25 (6.3)	9007B1	0.17 (0.063)
1.5 (38.1)	1.0 (25.4)	Optional	0.25 (6.3)	9007B2	0.19 (0.071)
1.5 (38.1)	1.38 (35)	Optional	0.25 (6.3)	9007B3	0.23 (0.085)
2.5 (63.5)	0.75 (19)	Optional	0.25 (6.3)	9007B7	0.25 (0.093)
2.5 (63.5)	1.0 (25.4)	Optional	0.25 (6.3)	9007B8	0.25 (0.093)
2.5 (63.5)	1.38 (35)	Optional	0.25 (6.3)	9007B9	0.27 (0.100)
1.5 (38.1)	0.75 (19)	Optional	0.5 (12.7)	9007B12	0.34 (0.126)
1.5 (38.1)	1.0 (25.4)	Optional	0.5 (12.7)	9007B13	0.34 (0.126)
1.5 (38.1)	1.38 (35)	Optional	0.5 (12.7)	9007B14	0.42 (0.156)
5 (127)	0.75 (19)	Optional	0.25 (6.3)	9007B19	1.0 (0.373)
2.88 (73.1)	0.75 (19)	No roller	—	9007B21	0.20 (0.074)
2.5 (63.5)	0.75 (19)	Optional	0.5 (12.7)	9007B22	0.22 (0.082)
2.5 (63.5)	1.0 (25.4)	Optional	0.5 (12.7)	9007B23	0.28 (0.104)
2.5 (63.5)	1.38 (35)	Optional	0.5 (12.7)	9007B24	0.36 (0.134)
(1) Adjustable	0.75 (19)	Optional	0.25 (6.3)	9007R18	0.50 (0.186)
(1) Adjustable	1.0 (25.4)	Optional	0.25 (6.3)	9007R19	0.50 (0.186)
(1) Adjustable	1.38 (35)	Optional	0.25 (6.3)	9007R20	0.50 (0.186)

(1) Does not include lever arm clamp or rod. If lever arm clamp is required, use 9007R16 or R17.

Offset Type (used to obtain different cam track dimensions)

Arm	Steel roller	Roller Position	Reference	Weight	
Length Inches (mm)	Diameter Inches (mm)	Width Inches (mm)		lb (kg)	
1.5 (38.1)	0.75 (19)	Inside offset	0.25 (6.3)	9007C1	0.50 (0.186)
1.5 (38.1)	1.0 (25.4)	Inside offset	0.25 (6.3)	9007C2	0.50 (0.186)
1.5 (38.1)	1.38 (35)	Inside offset	0.25 (6.3)	9007C3	0.50 (0.186)
1.5 (38.1)	0.75 (19)	Outside offset	0.25 (6.3)	9007D1	0.18 (0.067)
1.5 (38.1)	1.0 (25.4)	Outside offset	0.25 (6.3)	9007D2	0.18 (0.067)
1.5 (38.1)	1.38 (35)	Outside offset	0.25 (6.3)	9007D3	0.18 (0.067)
1.88 (48)	0.75 (19)	Outside offset	0.25 (6.3)	9007E4	0.20 (0.074)
1.88 (48)	1.0 (25.4)	Outside offset	0.25 (6.3)	9007E5	0.27 (0.100)
1.88 (48)	1.38 (35)	Outside offset	0.25 (6.3)	9007E6	0.27 (0.100)
1.88 (48)	0.75 (19)	Inside offset	0.25 (6.3)	9007F4	0.30 (0.112)
1.88 (48)	1.0 (25.4)	Inside offset	0.25 (6.3)	9007F5	0.30 (0.112)
1.88 (48)	1.38 (35)	Inside offset	0.25 (6.3)	9007F6	0.30 (0.112)

120° Forked (used with maintained contact lever arm type switches)

Arm	Steel roller	Roller	Reference	Weight	
Length Inches (mm)	Diameter Inches (mm)	Roller Position	Width Inches (mm)	lb (kg)	
1.5 (38.1)	0.75 (19)	Same side	0.25 (6.3)	9007J1	0.31 (0.115)
1.5 (38.1)	1.0 (25.4)	Same side	0.25 (6.3)	9007J2	0.40 (0.149)
1.5 (38.1)	0.75 (19)	LH on opp. side	0.25 (6.3)	9007K1	0.50 (0.186)
1.5 (38.1)	1.0 (25.4)	LH on opp. side	0.25 (6.3)	9007K2	0.50 (0.186)
1.5 (38.1)	0.75 (19)	RH on opp. side	0.25 (6.3)	9007N1	0.66 (0.246)
1.5 (38.1)	1.0 (25.4)	RH on opp. side	0.25 (6.3)	9007N2	0.70 (6.261)

90° Forked (used with maintained contact lever arm type switches)

Arm	Steel roller	Roller	Reference	Weight	
Length Inches (mm)	Diameter Inches (mm)	Roller Position	Width Inches (mm)	lb (kg)	
1.5 (38.1)	0.75 (19)	Same side	0.25 (6.3)	9007X1	0.30 (0.112)
1.5 (38.1)	1.0 (25.4)	Same side	0.25 (6.3)	9007X2	0.40 (0.149)
1.5 (38.1)	0.75 (19)	RH on opp. side	0.25 (6.3)	9007Y1	0.50 (0.186)
1.5 (38.1)	1.0 (25.4)	RH on opp. side	0.25 (6.3)	9007Y2	0.50 (0.186)
1.5 (38.1)	0.75 (19)	LH on opp. side	0.25 (6.3)	9007Z1	0.66 (0.246)
1.5 (38.1)	1.0 (25.4)	LH on opp. side	0.25 (6.3)	9007Z2	0.70 (0.261)

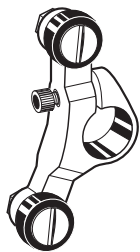

120° Forked

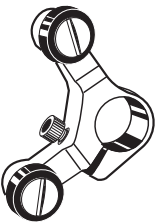

90° Forked

Severe Duty Limit Switches

9007 Mill and Foundry Switches

Lever Arms and Replacement Parts

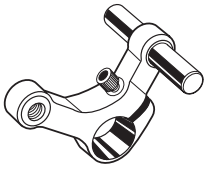

With Reset

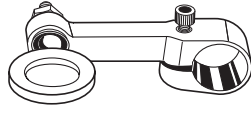

With Spring

Cable Operated

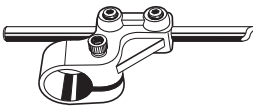

Rod Type



Ball Bearing Type



Weld-On Type

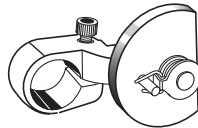

1-Way Roller Type

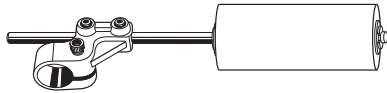

Conveyor Side Guide

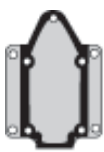

Style C



Style D



Style B

Base Plates

Cable operated

Arm Length Inches (mm)	Steel roller Diameter Inches (mm)	Roller Position	Width Inches (mm)	Reference	Weight lb (kg)
1.5 (38.1)	0.75 (19)	None	None	9007Y3	-
2.5" (63.5mm) long with eyebolt 0.25 (6.3mm) I.D. instead of roller.				9007B27	-
Rod Type (used on conveyor systems or where unusual shapes are required)					
Adjustable	0.75 (19)	(1) 0.19 (4.8)	None	9007R16	0.18 (0.067)
Adjustable	0.75 (19)	(2) 0.25 (6.3)	None	9007R17	0.18 (0.067)

(1) Rod not included

(2) Key stock not included

Ball Bearing Type (for abrasive dust areas or with high speed cams)

1.5 (38.1)	0.75 (19)	Center	0.28 (7.1)	9007B16	0.15 (0.055)
------------	-----------	--------	------------	---------	--------------

Weld-On Type (used where a special operator is required to weld to lever)

3.5 (89)	0.75 (19)	None	None	9007G10	0.50 (0.186)
----------	-----------	------	------	---------	--------------

One Way Roller Type (used with reversible cams for one way operations)

1.5 (38.1)	0.75 (19)	Outside offset	0.25 (6.3)	9007D4	0.64 (0.238)
------------	-----------	----------------	------------	--------	--------------

Conveyor Side Guide

8.44" (214.3) long with 1.5" (38.1) dia. 3.75" (95.2) Delrin roller	9007R21	1.63 (0.608)
8.44" (214.3) long with 0.88" (22.3) dia. 3.75" (95.2) Delrin roller	9007R22	1.42 (0.530)

Separate Base Plates (2)

Style	Mounting Holes	Reference	Weight lb (kg)
A	None (1)	2934D32G1	
B	End	2934D14G1	0.34 (0.126)
C	Side	2934D33G1	0.42 (0.156)
D	End	2934D34G1	0.36 (0.134)

(1) No mounting holes in base plate. Side mounting holes in switch case must be used.

(2) Acceptable wire sizes 14 – 18 AWG (2.08 – 0.823 mm²); recommended terminal clamp torque 13 – 16 lb-in. (1.46 – 1.80 N•m).

Optional Conduit Threads

Description	Reference	Weight lb (kg)
Metric		
M20 - 20mm (per B.S. 4568)	M11	
Example: 9007TUB4M11		

Three Point Contacts — Ordering Information

Select Type number of desired contact operating sequence for standard contact switch. Change the letter following "T" or "FT" as shown below.

Change: U to Y Contact Configuration Changes
S to K From:

For example:
TUB1 changes to TYB1
TSB1 changes to TKB1



Surface Mounting

Type T

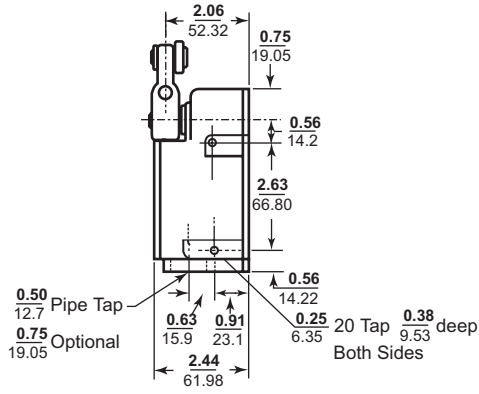

Type FT

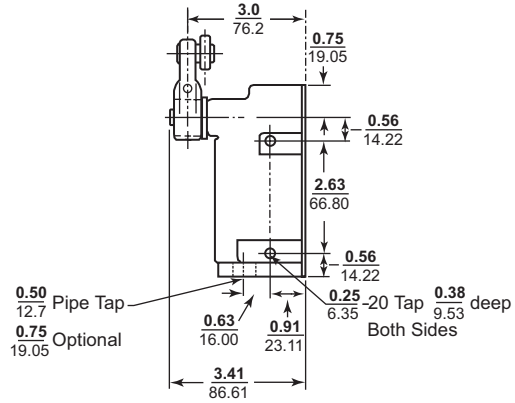

Base Plates

Style A

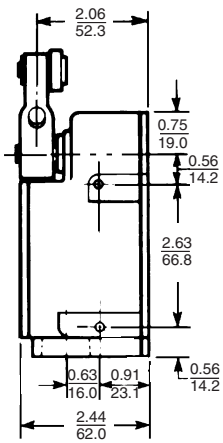

Style B

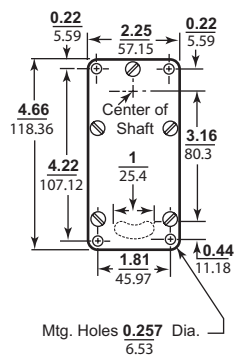

Style C

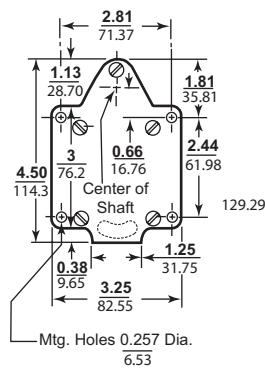

Style D

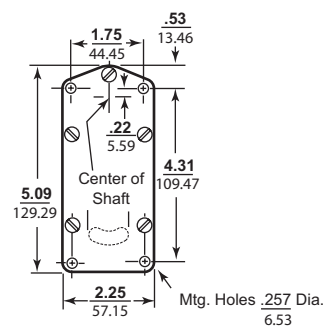

Dual dimensions: $\frac{\text{inches}}{\text{mm}}$

CAM Track Dimensions

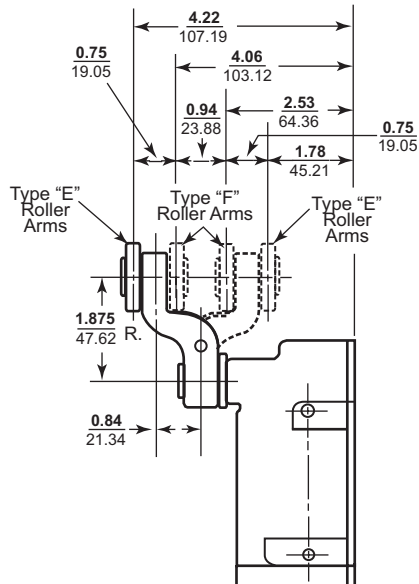
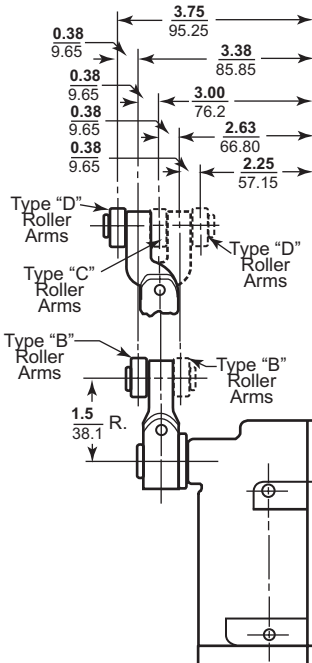
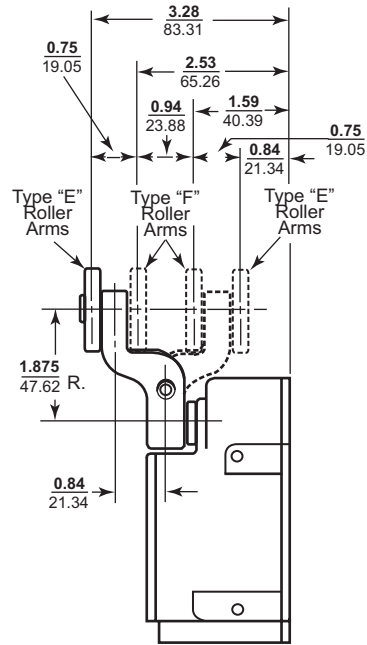
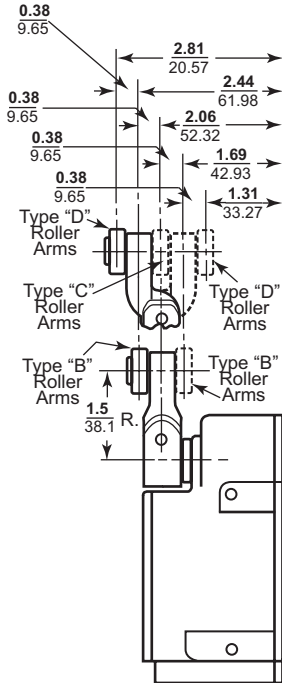

Dual dimensions: inches
mm

Severe Duty Limit Switches

9007 Mill and Foundry Switches
Lever Arms

Type T and FT Lever Arms

Standard Roller

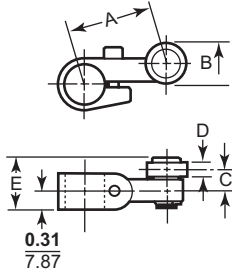

For dimension A refer to page 12.

Offset Type

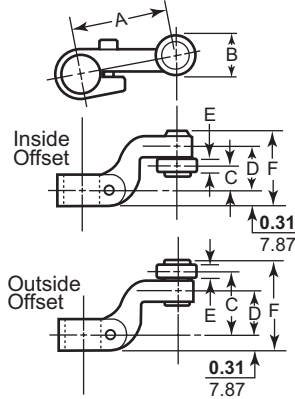

Adjustable Length Rod Type

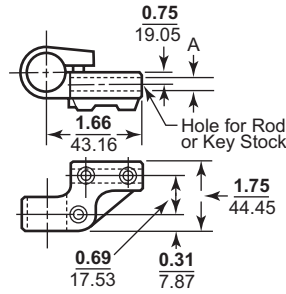

Ball Bearing Roller Type B16

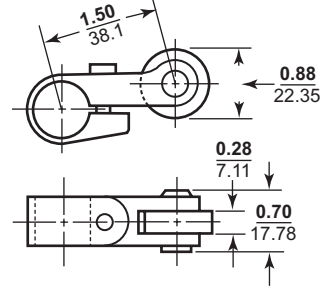

Roller Arm for use with Type R17

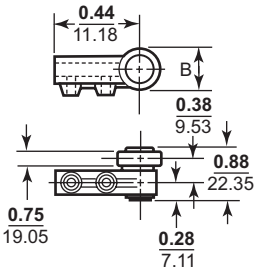

1-Way Roller Type D4

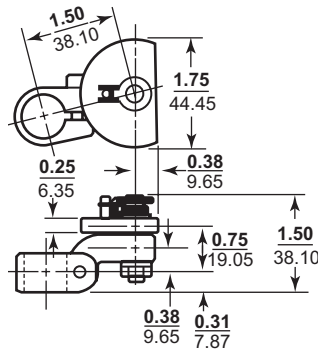

Weld-On Arm Type G10

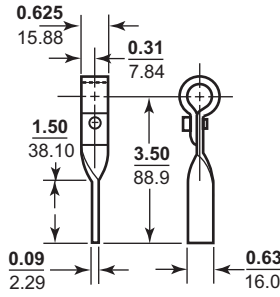

Cable Operated with Reset Type Y3

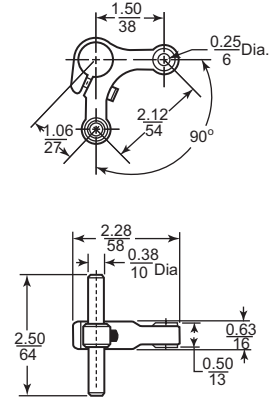

Cable Operated Type B27

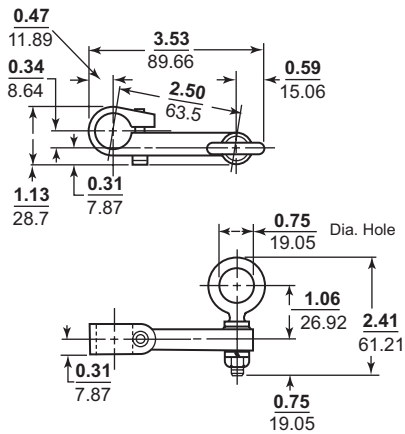

Dual dimensions: $\frac{\text{inches}}{\text{mm}}$

Severe Duty Limit Switches

9007 Mill and Foundry Switches
Lever Arms

Type T and FT Lever Arms (continued)

90° Forked

120° Forked

