

D.34B Long-reach 6-spline bit

- For removing cylinder head screws.
- Square drive : \square : 1/2".

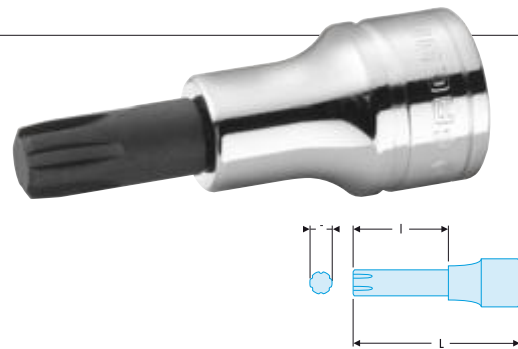



	Ø mm	l mm	L mm	ΔΔ g
D.34B7	7	15	60	70
D.34B7L	7	63	100	120
D.34B9L	9	63	100	130
D.34B10	10	15	60	75
D.34B12L	12	63	100	140
D.34B14L	14	63	100	150
D.34B16L	16	63	100	160



12-piece set of 1/2" square drive sockets with long-reach monobloc TORX®, XZN and hex. bits

MOD.SHP

- Ideal for light vehicle cylinder heads.
- Tray PL.336.
- Dimensions : 420 x 180 x 55 mm.

				ΔΔ kg
MOD.SHP	40 - 45 - 55 - 70	5 - 6 - 7 - 8	6 - 8 - 10 - 12	1,740



Set of TORX® sockets

MOD.TX1

- Set of Torx® wrenches.
- ΔΔ : 995 g.



7-piece set of 6-spline bits \square 1/2"

D.34J7PF

- Supplied on a rack.
- Comprising : D.34B7, 34B7L, 34B9L, 34B10, 34B12L, 34B14L, 34B16L.
- ΔΔ : 900 g.



5-piece set of drive bits for spline socket head (XZN) \square 1/2"



SV.J5PF

- Supplied on a rack.
- Diameters 6, 8, 10, 12, 14.
- Bits 63 mm - total 100 mm.
- ΔΔ : 670 g.



20-piece set of short-reach bits

SE.1APB

- Comprising :
 - 1 bit holder \square 1/2", \varnothing 5/16".
 - 5  hexagonal bits 4 to 10 mm.
 - 8  Torx® bits no. 20 to 55.
 - 4 XZN bits 6 to 12 mm.
 - 3  Pozidriv® bits no. 2 to 4.
- ΔΔ : 475 g.

