

## Single head system



## UB2000-30GM-E2-V15

### Features

- Switch output
- 5 different output functions can be set
- TEACH-IN input
- Synchronisation options
- Deactivation option
- Watchdog

### Electrical connection

Standard symbol/Connections:  
(version E2, pnp)

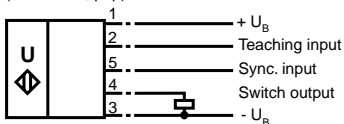

## Dimensions

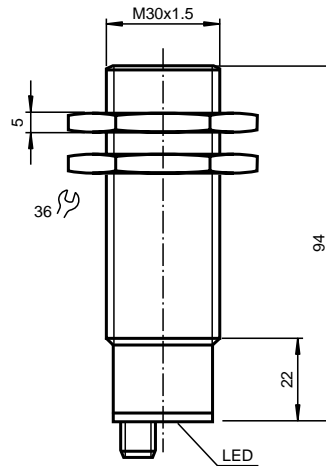

### Technical data

#### General specifications

Sensing range	200 ... 2000 mm
Standard target plate	100 mm x 100 mm
Unusable area	0 ... 200 mm
Transducer frequency	approx. 175 kHz
Response delay	approx. 145 ms
Standard conformity	EN 60947-5-2

#### Indicating/Operating means

LED green  
LED yellow  
LED red

"Power on", TEACH-IN function object detected  
Indication of the switching state, Teach-in function-no object detected  
"Error", object uncertain

#### Electrical specifications

Rated operational voltage $U_e$	20 ... 30 V DC, ripple $\pm 10\%$ % <sub>SS</sub>
No-load supply current $I_0$	$\leq 60$ mA

#### Output

Output type	1 switch output E2/E3, pnp, normally open/closed, programmable
Rated operational current $I_e$	200 mA, short circuit/overload protected
Voltage drop $U_d$	$\leq 3$ V
Switching frequency $f$	max. 3.4 Hz
Range hysteresis $H$	$\leq 1\%$ of the set operating distance
Repeat accuracy	$\leq 1\%$
Temperature influence	0.17 % / K

#### Input

Input type	1 TEACH-IN input, operating distance 1: $-U_B \dots (-U_B + 2 V)$ operating distance 2: $(+U_B - 2 V) \dots +U_B$ 1 synchronous input level 0: $-U_B \dots (-U_B + 1 V)$ , level 1: $(-U_B + 5 V) \dots +U_B$ Input impedance 27 kOhm Synchronisation pulse: $\geq 100 \mu s$ Synchronisation pulse pause: $\geq 100 \mu s$
------------	-----------------------------------------------------------------------------------------------------------------------------------------------------------------------------------------------------------------------------------------------------------------------------------------------------------------------------------------------

#### Pulse length

Synchronisation frequency	$\leq 40$ Hz
Common mode operation	$\leq 40/n$ Hz, n = number of sensors

#### Ambient conditions

Ambient temperature	$-25 \dots +70$ °C (248 ... 343 K)
Storage temperature	$-40 \dots +85$ °C

#### Mechanical specifications

Protection degree	IP65 according to EN 60529
Connection type	connector V15

#### Material

Housing	brass, nickel plated, plastic components PBT
Transducer	epoxy resin/hollow glass sphere mixture; polyurethane foam
Mass	145 g

## Note

### Function

#### Synchronisation

The sensor features a synchronisation input for the suppression of mutual interference. It can be synchronised by applying a square wave voltage. The falling edge of a synchronisation pulse at the synchronisation input starts a measuring cycle. A low level > 1 s or an open synchronisation input will result in the non-synchronised normal operation of the sensor. A high level at the synchronisation input disables the sensor. Synchronisation cannot be performed during TEACH-IN and vice versa. Two operating modes are possible:

1. Multiple sensors can be controlled by the same synchronisation signal. The sensors are synchronised.
2. The synchronisation pulses are sent cyclically to individual sensors. The sensors operate in multiplex mode.

#### Setting the switching points

The ultrasonic sensor features a switch output with two teachable switching points. These are set by applying the supply voltage -UB or +UB to the TEACH-IN input. The supply voltage must be applied to the TEACH-IN input for at least 1 s. LEDs indicate whether the sensor has recognised the target during the TEACH-IN procedure. Switching point A1 is taught with -UB, A2 with +UB.

Five different output functions can be set:

Function	TEACH-IN procedure
Window mode, close function	<ul style="list-style-type: none"> <li>- Set object to near switching point</li> <li>- Teach switching point A1 with -UB</li> <li>- Set object to far switching point</li> <li>- Teach switching point A2 with +UB</li> </ul>
Window mode, open function	<ul style="list-style-type: none"> <li>- Set object to near switching point</li> <li>- Teach switching point A2 with +UB</li> <li>- Set object to far switching point</li> <li>- Teach switching point A1 with -UB</li> </ul>
1 switching point, close function	<ul style="list-style-type: none"> <li>- Set object to near switching point</li> <li>- Teach switching point A2 with +UB</li> <li>- Cover sensor or remove all objects from sensing range</li> <li>- Teach switching point A1 with -UB</li> </ul>
1 switching point, open function	<ul style="list-style-type: none"> <li>- Set object to near switching point</li> <li>- Teach switching point A1 with -UB</li> <li>- Cover sensor or remove all objects from sensing range</li> <li>- Teach switching point A2 with +UB</li> </ul>
Detection of object presence	<ul style="list-style-type: none"> <li>- Cover sensor or remove all objects from sensing range</li> <li>- Teach switching point A1 with -UB</li> <li>- Teach switching point A2 with +UB</li> </ul>

Default setting of switching points: A1 = blind range, A2 = nominal distance

Displays in dependence on operating mode	Green LED	Red LED	Yellow LED
Teach switching point			
Object detected	Flashing	Off	Off
No object detected	Flashing	Off	On
Object uncertain (TEACH-IN invalid)	Off	Flashing	Off
Normal operation	On	Off	Switching state
Interference (e.g. compressed air)	Off	Flashing	Previous state

## Model number

UB2000-30GM-E2-V15

## Characteristic curves/ Additional information

### Characteristic response curves

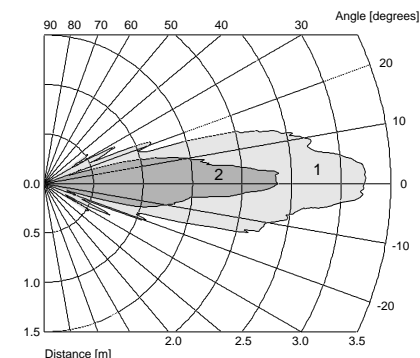

Curve 1: flat plate 100 mm x 100 mm  
Curve 2: round bar, Ø 25 mm

### Programmed switching output function

Window operation, normally open function

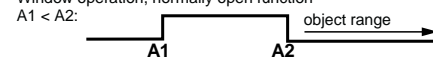

Window operation, normally closed function

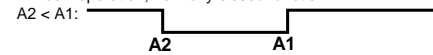

One switch point, normally open function

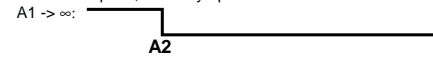

One switch point, normally closed function

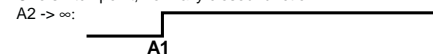

A1 -> ∞, A2 -> ∞: Detection of presence of object

Object detected: Switch output closed

No object detected: Switch output open

### LED-Window

