

AB
Mk 02,

World Patents

Type	Min. O/D	Max. O/D
MK02	12 mm	32 mm

These tools are manufactured from high grade quality materials to withstand the requirements of heavy industrial and installation usage.

The Cutting Blades and Wheels are made of high speed steel and are rigidly and precisely mounted in interchangeable cartridges

The stripping blades are designed to remove insulations from a wide variety of cables up to a maximum thickness of 6 mm

The cutting wheels are suitable for removal of metal cladding and braiding of copper, aluminium or lead

This range of strippers is equally effective for mid-span stripping or end stripping. Circumferential or longitudinal or spiral cuts are easily achieved by twisting the cutting head into predetermined index position

These tools are particularly suitable for field and installation work as they can operate easily in confined spaces and awkward positions.

This range of Heavy Duty Cable Strippers is suitable for stripping insulation from large cables

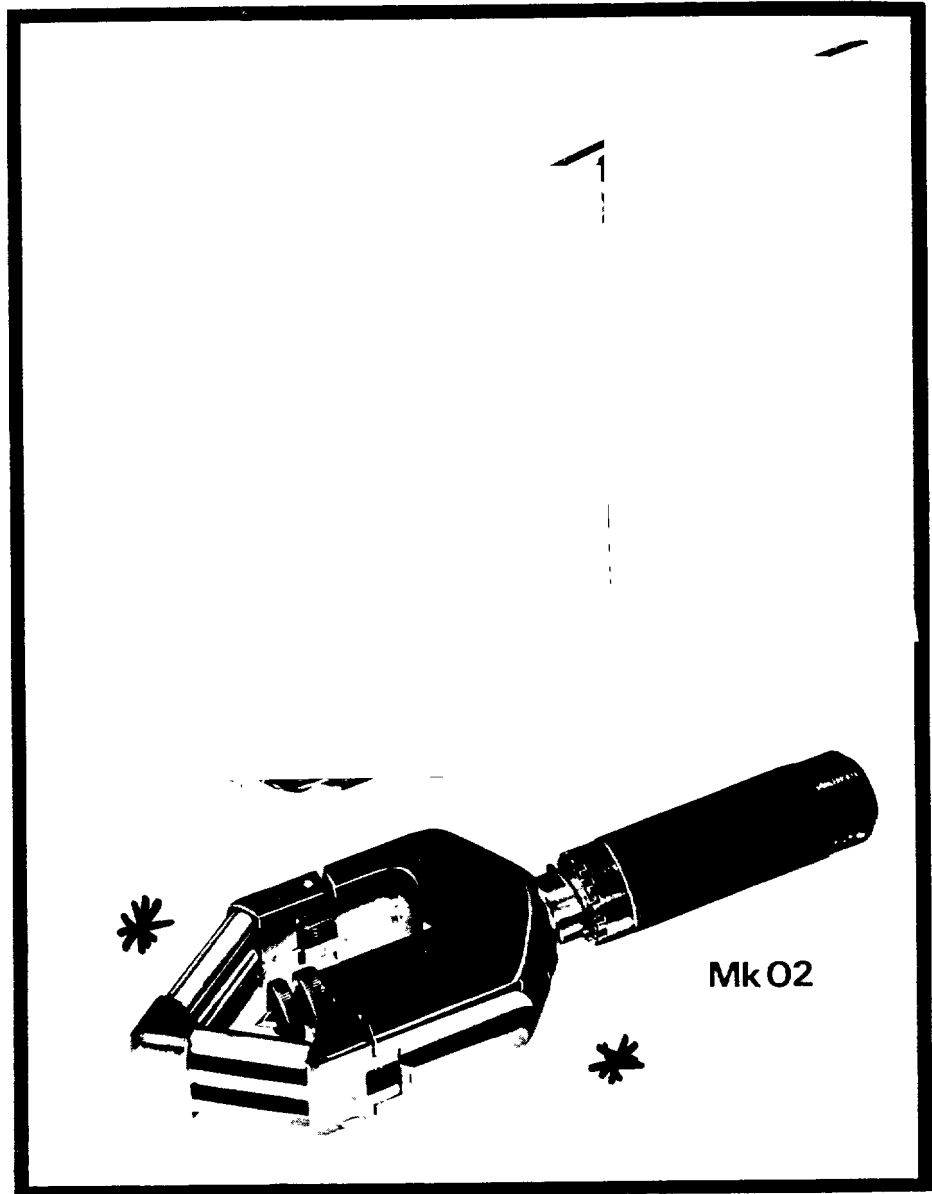

AB ENGINEERING COMPANY
Proprietors: ABECO Ltd.
Apem Works St. Albans Road
Watford WD2 4AN
Tel: Watford 41208 and 20656
Telex 923405

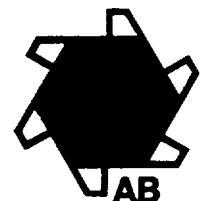

440-796

The three tools in this range are supplied complete with cartridges as indicated in table 1.

Also available as extra items are wheel cutting cartridges in lengths 1 and 2 with various depths of cut (Fig. 1). Reference should be made to Table 2 when ordering wheel cartridges for specific depths of cut. Support rollers are supplied with all cartridges, but are not normally used for cable diameters of less than 20mm.

Mk. 02	Cutting cartridge complete with roller support (length 1).
--------	--

The range of insulation on modern cables varies enormously and this range of tools will deal with the majority of insulations in a precise manner. The selection of spiral cutting or longitudinal cutting is dependent upon the type of insulation and the cable diameter, but broadly speaking, the spiral cut (Fig. 2) is used for the tougher and larger cables and the longitudinal cut (Fig. 3) is used for the smaller diameter cables.

TABLE 1

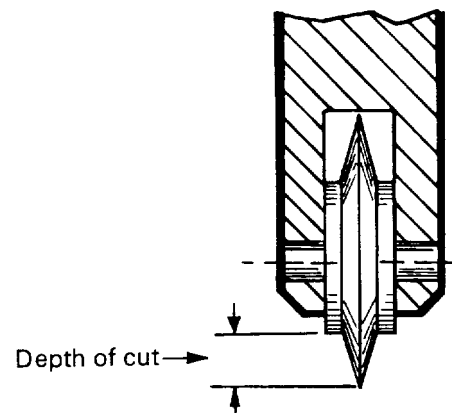

CUTTING WHEEL DETAIL Fig. 1

SPIRAL CUT
Cartridge in 'blue' position

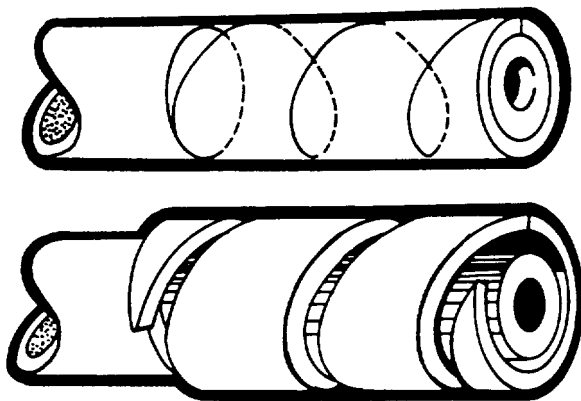

Fig. 2

STRAIGHT CUT
Cartridge in 'white' position

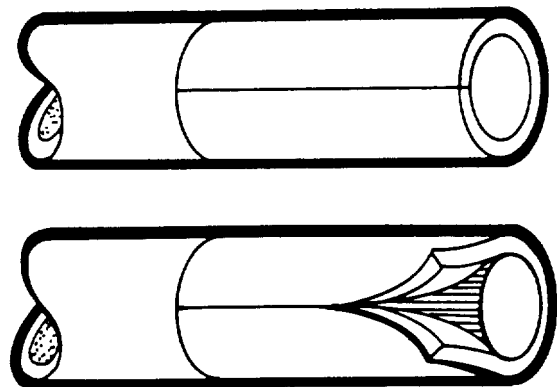

Fig. 3

Remove insulation with fingers or blunt screwdriver after cutting.

Special Applications

There are many and varied applications of this versatile range of tools and these will become apparent to the user in practice. This tool is particularly suitable for connecting and jointing the aluminium sheathing on power installations.

Wheel Cutting Cartridges

When ordering standard wheel cutting cartridges please specify depth of cut required, outer diameter of sheathing, and the type of tool for which required, (02, 03 or 04). Table 2 shows typical cables, sheath dimensions and appropriate cutting wheels. Other depths of cut can be supplied to special order.

TABLE 2

11KV. Aluminium Sheathed Cable (B.I.C.C.)			
Conductor Nominal area (sq mm)	Plain Sheath		Cutting Wheel Ref. No.
	Nom. Dia. mm	Thickness mm	
70	36.8	1.5	3
95	40.2	1.6	3
120	43.3	1.8	4
150	46.1	1.9	4
185	49.5	2.0	5
240	54.3	2.2	6
300	58.8	2.4	7
Corrugated Sheath			
70	39.9	1.1	1
95	43.7	1.2	1
120	47.6	1.3	2

Specification

	Size	Weight
Mk. 02	50 x 30 x 190mm	320gms.

TYPICAL APPLICATIONS

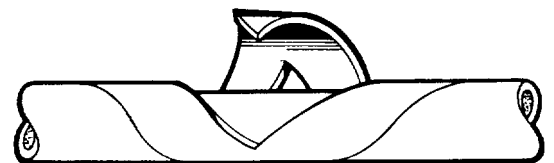
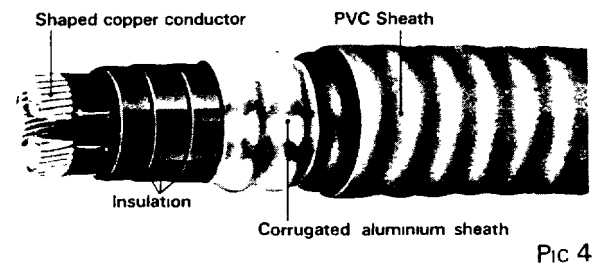
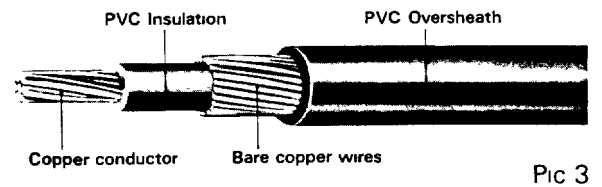
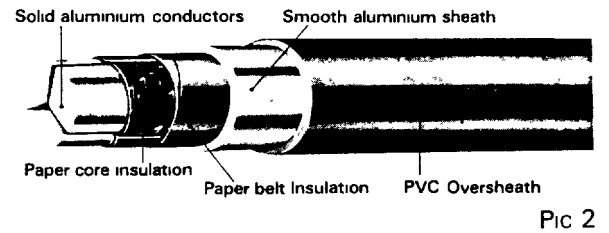
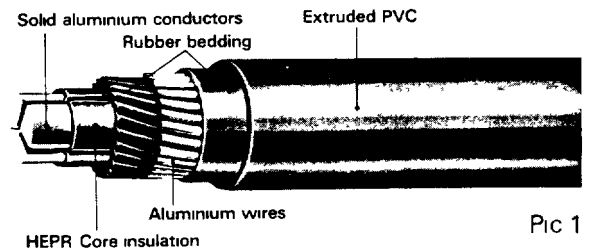

4 spiral cuts to prepare aluminium sheath for connection.

Fig. 5

TOOL OPERATION

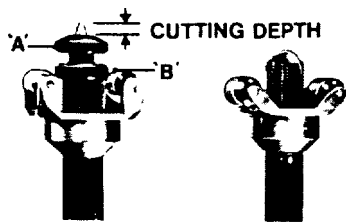

1. SET CUTTING DEPTH Remove cartridge from tool and adjust cutting depth by means of the knurled stop 'A'. Lock in position with lock nut 'B'. The correct cutting depth should be measured against the cable to be stripped

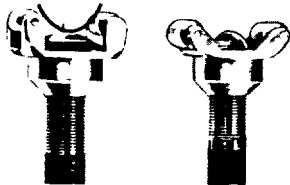

2. SET ROLLER SUPPORT For certain cables it will be necessary to use the roller support 'C' and after setting the cutting depth the rollers should be adjusted to touch the outside of the cable with the cutting blade penetrating the insulation to the correct depth

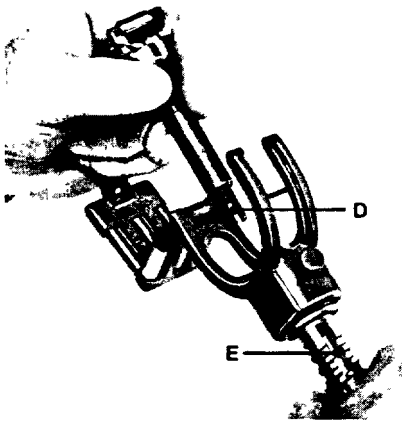

3. CARTRIDGE INSERTION After setting, replace cartridge in tool by pressing firmly home. **Note.** The slot (D) in the base of the cartridge should be in line with the slots (E) in the handle

On the base of the tool yoke are 3 coloured marks which when in line with the slots (E) on the tool handle, give the following types of cut —

Colour	Type of cut
Yellow	Circular
White	Longitudinal
Blue	Spiral

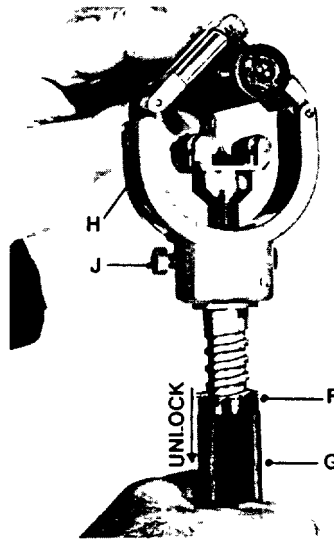

4. Unlock castellated barrel lock (F) by sliding knurled sleeve (G) on handle in direction of arrow and disengaging pins from castellations (H) and place round cable at desired location

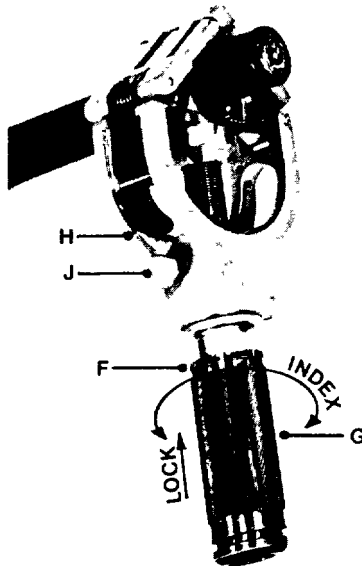

Close tool engaging catch (H) and screw handle in clockwise direction until blade penetrates to stop (A), and the rollers are touching cable. Release pin (J), index cutting blade to the correct position for the cut required and lock castellated barrel by sliding sleeve (G) forward to engage pins in castellations. Engage pin (J) to lock the indexed position

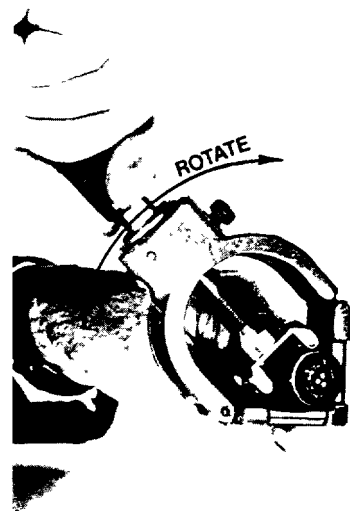

5. Rotate tool round cable until complete circumferential penetration of insulation has been achieved

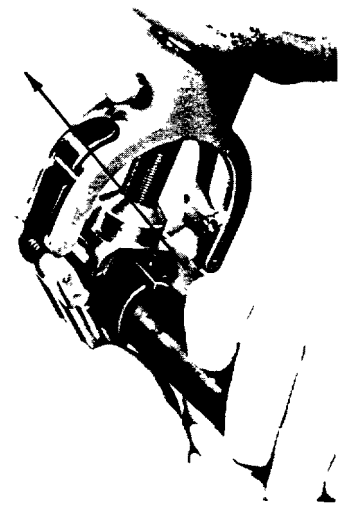

6. Release pin (J) and select longitudinal cut by rotating handle to 90° white index position. Lock pin (J). Then slide tool in direction of arrow to cut insulation longitudinally to the end of the cable. Then the insulation can be prised off with fingers or blunt tool. If a spiral cut, rather than a longitudinal cut is required release pin (J) and select blade position by rotating handle to first (30°) blue index position. Lock pin (J) and rotate tool around cable.