

CMYK ■ PMS 425C ■ PMS 151C

TENMA®



DSO Series OPERATING MANUAL

Digital Storage
Oscilloscope

TENMA[®]

**Color Digital Storage
Oscilloscope Series
OPERATING MANUAL**

Table of Contents

Chapter	Title	Page
	General Safety Rules - - - - -	3
	Preface - - - - -	5
Chapter 1	User Guide - - - - -	9
	General Check- - - - -	13
	Functional Check - - - - -	13
	Probe Compensation- - - - -	16
	Autoset Waveform Display - - - - -	17
	Getting to Know the Vertical System - - - - -	18
	Getting to Know the Horizontal System- - - - -	19
	Getting to Know the Trigger System- - - - -	21
Chapter 2	Instrument Setups - - - - -	23
	Setting up the Vertical System - - - - -	23
	Setting up the Horizontal System - - - - -	35
	Setting up the Trigger System- - - - -	39
	Alternate Trigger - - - - -	46
	Setting up the Sampling System- - - - -	51
	Setting up the Display System- - - - -	55
	Save and Recall - - - - -	56
	Setting up Alternative Functions- - - - -	59
	Auto Measurement - - - - -	62
	Cursor Measurement - - - - -	70

Table of Contents

Chapter	Title	Page
Chapter 3	Using the Run Button	71
	Practical Example Scenarios	74
	Scenario 1: Measuring simple signals	74
	Scenario 2: Observing the delay caused by a sine wave signal passing through a circuit	75
	Scenario 3: Acquiring single signal	77
	Scenario 4: Reducing random noise of signals	78
	Scenario 5: Using cursors for measurement	80
Chapter 4	Scenario 6: Using the X-Y function	82
	Scenario 7: Video signal triggering	84
	System Prompts and Troubleshooting	86
Chapter 5	Definitions of System Prompts	86
	Troubleshooting	86
	Appendixes	88
	Appendix A: Technical Indicators	88
	Appendix B: Accessories for Tenma DSO Series Oscilloscopes	96
Index	Appendix C: Maintenance and Cleaning	96
		97

General Safety Rules

This Meter complies with the standards IEC61010: in pollution degree 2, overvoltage category (CAT I 1000V, CAT II 600V) and double insulation.

CAT. I: Signal level, special equipment or parts of equipment, telecommunication, electronic, etc., with smaller transient overvoltages than overvoltages CAT. II.

CAT. II: Local level, appliance, PORTABLE EQUIPMENT etc., with smaller transient overvoltages than CAT. III

To avoid personal injury and damage to this product or any other connected units, please take time to read the following safety precautions. To avoid any potential danger, please use this product strictly in accordance with use instructions and safety rules.

Maintenance should be carried out only by qualified personnel.

Avoid fire and personal injury.

Use the correct power cord. Use only a design-

ated power cord specified for this product and certified for the country of use.

Use the correct power plug. Do not remove the plug when the probe or test cable is connected to the power source.

Ensure the product is properly grounded. This product should be properly grounded with the earth wire of the power cord. To avoid electric shock, the ground conductor must be connected to earth ground. Please ensure that the product is properly grounded before connecting any input or output terminal.

Connect the oscilloscope probe properly. Earth wire of the probe is in the same voltage as the earth. Do not connect the earth wire to high voltage.

Observe all terminal rated values. To avoid fire and impact caused by excessive electric current, check all rated values and labels on the product. Please read detailed information of rated values in the product manual before connecting the product.

Do not operate this product without Cover.

DSO Series User Manual

When the exterior cover or front panel is open, do not operate the product.

Use appropriate fuses. Use only the type of fuse and rated indicator designated for this product.

Avoid exposing circuitry. Upon power connection please do not touch any exposed adaptor or component.

Do not operate with suspected failure. If you suspect the product is damaged, have it inspected by a qualified maintenance technician.

Maintain good ventilation.

Do not operate in a humid place.

Do not operate in combustible and explosive conditions.

Keep the product surface clean and dry.

Safety Messages and Symbols

Messages on the product: The following messages may appear on the product:

“Danger” means potential damage that is immediate.

“Warning” means potential damage that is not immediate.

Warning: Warning statements identify conditions or actions that could result in injury or loss of life.

Caution: Caution statements identify conditions or actions that could result in damage to this product or other property.

“Caution” means possible damage to this product or other properties.

Symbols on the product: The following symbols may appear on the product:

High voltage



Caution! Refer to manual



Protective earth terminal



Earth terminal for chassis



Earth terminal for testing



Preface

This manual provides information on the operation of Tenma DSO digital storage oscilloscope series. Guidance is given in several chapters as follows:

Chapter 1 User Guide: Simple guide to the oscilloscope functions and notes on installation.

Chapter 2 Instrument Setups: Guide to oscilloscope operation.

Chapter 3 Practical Example Scenarios: Example scenarios are provided to solve various testing problems.

Chapter 4 System Prompts and Trouble-shooting

Chapter 5 Servicing and Support

Chapter 6 Appendixes

Appendix A: Technical Indicators

Appendix B: Accessories for Tanma DSO Oscilloscopes

Appendix C: Maintenance and Cleaning

DSO Series User Manual

Tenma DSO Series Oscilloscopes:

Tenma oscilloscopes offer user-friendliness, outstanding technical indicators and a host of advanced features. They are your perfect tools to complete testing tasks swiftly and efficiently.

This manual is a user guide for four Tenma models:

Model	Bandwidth	Sampling Rate	Display
72-8395	25MHz	250MS/s	Colour
72-8390	40MHz	500MS/s	Colour
72-8385	100MHz	500MS/s	Colour
72-8380	200MHz	500MS/s	Colour
72-8225	40MHz	500MS/s	Colour
72-8230	60MHz	500MS/s	Colour
72-8240	100MHz	500MS/s	Colour
72-8245	150MHz	500MS/s	Colour
72-8250	200MHz	500MS/s	Colour

Tenma DSO oscilloscopes offer user-friendly front panel that allows access to all functions easy operation. The scaling of all channels and the positions of buttons are optimally arranged for direct view operation. As design is based on the mode of traditional instruments, users can use the new units without spending considerable time in learning and familiarizing with operation. For faster adjustment to ease testing, there is an **AUTO** key. The new units also feature more appropriate waveform and range scale positions.

In addition to easy operation, the Tenma DSO series have all the high performance indicators and powerful functions that ensure speedy testing and measurement. With 500MS/s real-time sampling rate and 25GS/s equivalent sampling rate, these oscilloscopes can display signals much quicker, while powerful trigger and analytical features enable easy capture and analysis of waves, while a clear LCD display and mathematics functions enable the user to observe and analyse signal problems promptly and clearly.

The performance features listed below will explain why the new series can fully satisfy your testing and measurement requirements:

- Dual analog channels
HD color LCD display at 320 x 240 resolution
- Supports plug-and-play USB storage devices and capable of communicating with a computer through the USB storage device
- Automatic waveform and status configuration
- Storage of waveforms, setups and bit map and waveforms, setups recurrence
- Sophisticated window expansion function to analyse waveform details and overview precisely
- Automatic measurement of 19 waveform parameters
Automatic cursor tracing measurement
- Unique wave recording and replay function
- Built-in FFT
- Multiple waveform mathematics functions (including add, subtract, multiply and divide)
- Edge, video, pulse width and alternate trigger functions
- Multilingual menu displays
- Chinese and English Help System

DSO Series User Manual

Included accessories

- 2 x 1.2m, 1:1/10:1 probe (see passive voltage probe operating manual) , comply with EN61010-031: 2002 standard.
- Power supply line conforming to all international standards
- User Manual
- Communications software (USB/RS-232C)

- USB Lead: UT-D04

The Tenma DSO Series are small and compact benchtop oscilloscopes. The user-friendly front panel enables easy operation for basic testing and measuring tasks.

This chapter provides notes on the following:

- General check
- Functional check
- Probe compensation
- Automatic settings for waveform display
- Getting to know the vertical system
- Getting to know the horizontal system
- Getting to know the trigger system

Chapter One User Guide

When starting to use a new oscilloscope, the first step is always to familiarize yourself with the use of the front operation panel. This rule of thumb applies to Tenma Digital Oscilloscopes. This chapter briefly describes the operation and functions of the front panel, so you can learn how to use a Tenma Digital Oscilloscope as quickly as possible.

Tenma DSO Series provides a front panel with at-a-glance functions for easy operation. There are buttons and function keys on the front panel. The functions of buttons are similar to other oscilloscopes. The row of 5 keys on the right of the display panel are the menu operation keys (designated as F1 to F5 from top to down). With these keys you can set up different options of the current menu. The other keys are function keys. You can use them to enter different function menus or access particular functions directly.

DSO Series User Manual

Figure 1-1 Front panel

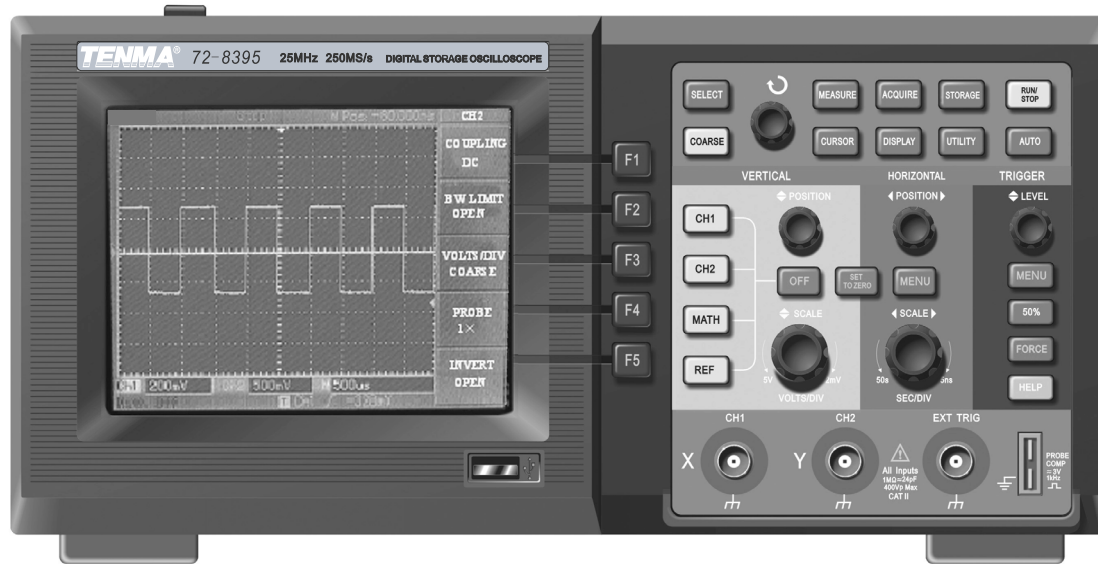

Figure 1-1

Figure 1-2 Functional Controls and Connections

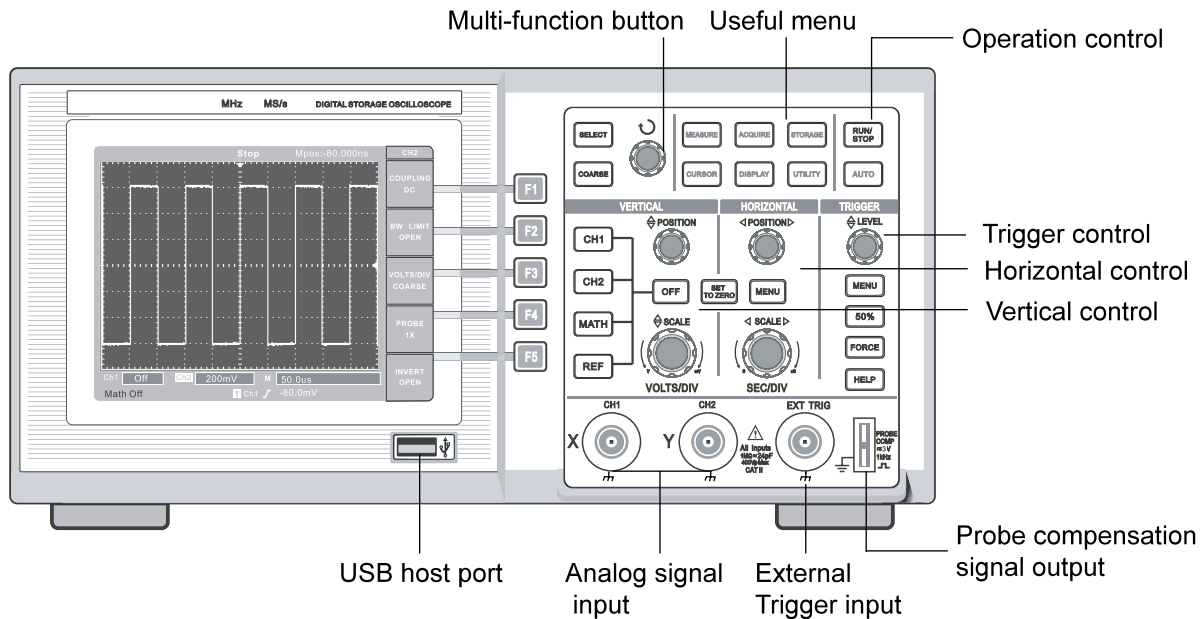

Figure 1-2

DSO Series User Manual

Indicative definitions in this manual:

Text indications for operation keys given in this manual are identical to signs on the front panel keys.

Please note that all signs for measurement function keys appear with frames, e.g. [MEASURE], to represent a front panel function key marked with the word MEASURE.

Signs for the operation keys on the menu are in shadowed text, e.g. SAVE WAVEFORM, to indicate the save waveform option of the save menu.

Figure 1-3 Schematic diagram for the display interface

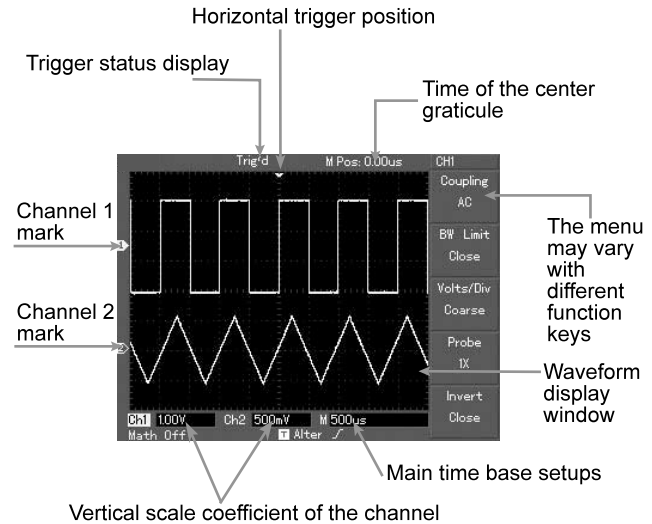

Figure 1-3

General Check

We suggest checking your new Tenma DSO oscilloscope in the following steps.

1. Check the unit for possible shipping damages

If the package carton or foam plastic protective lining is seriously damaged, please do not discard until you have carried out a check on the entire unit and accessories to ensure satisfactory electrical and mechanical performance.

2. Check the accessories

A checklist of accessories included with your Tenma Digital Storage Oscilloscope is provided on page 8 of this manual. Please check for any missing items against this list.

If any item is missing or damaged, please contact your Tenma dealer or our local office.

3. Thorough inspection of the entire unit

If the exterior of the unit is damaged, or it is

not operating normally or it fails to pass performance tests, please contact your Tenma dealer or our local office.

In the event of shipping damage, please retain the packaging and inform our shipping department or your Tenma dealer. Tenma will arrange for repair or replacement.

(For specific inspection guide see the next section)

Functional Check

Carry out a quick functional check in the following steps to make sure your oscilloscope is operating normally.

1. Power on the unit

Power on the unit. Power supply voltage is 100-240V AC, 45-440Hz. After connecting to power, let the unit carry out self-calibration to optimize the oscilloscope signal path for measurement accuracy. Press the [UTILITY] button and then [F1] to start the calibration. Then press [F1] on the next page to display

DSO Series User Manual

DEFAULT SETUP. See Figure 1-4 for details.
When the above procedure is complete, press [CH1]
to enter the CH1 menu.

Figure 1-4

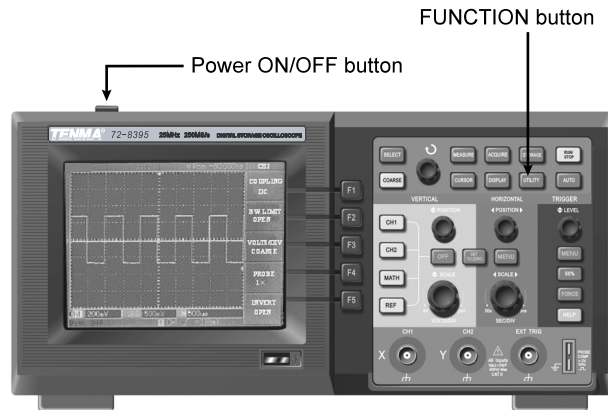

Figure 1-4

Warning: Ensure oscilloscope is securely grounded to avoid danger

2. Accessing signals

The Tenma DSO Oscilloscopes have dual input channels and one external trigger input channel. Please access signals in the following steps:

- ① Connect the probe to the CH1 input, and set the attenuation switch of the probe to 10X (Figure 1-5).

Figure 1-5 Setting the attenuation switch

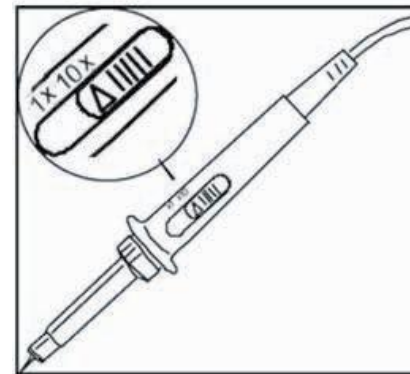

Figure 1-5

②. You have to set the probe attenuation factor of the oscilloscope. This factor changes the vertical range multiple to ensure the measurement result correctly reflects the amplitude of the measured signal. Set the attenuation factor of the probe as follows: Press [F4] to display 10X on the menu.

Figure 1-6 Deflection factor setting of the probe on the oscilloscope

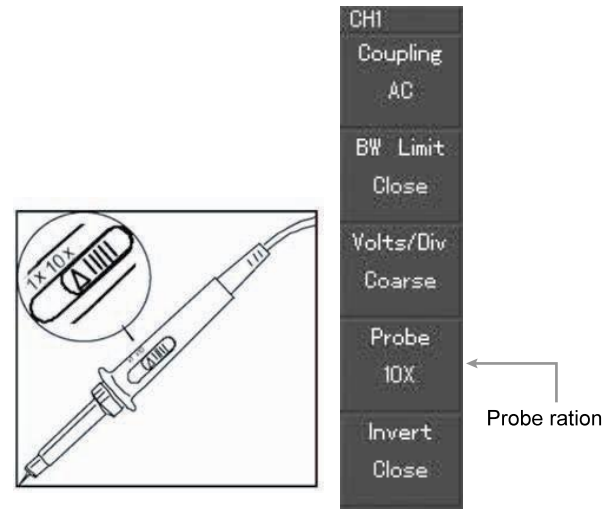

Figure 1-6

DSO Series User Manual

①. Connect the probe tip and ground clamp to the corresponding probe compensation signal terminals. Press [AUTO] and you will see a square wave in the display of about 3V peak-to-peak at 1kHz in a few seconds. See Figure 1-7 for details. Repeat these steps to check CH2. Press [OFF] function button to disable CH1, then press [CH2] function button to enable CH2. Repeat steps 2 and 3.

Figure 1-7 Probe compensation signal

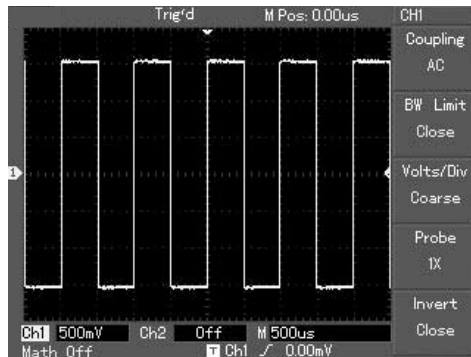

Figure 1-7

Probe Compensation

When connecting the probe to any input channel for the first time, perform this adjustment to match the probe to the channel. Skipping the compensation calibration step will result in measurement error or fault. Please adjust probe compensation as follows:

1. In the probe menu set the attenuation factor to 10X. Move the switch on the probe to 10X and connect the probe to CH1. If you are using the probe hook-tip, ensure a proper and secure connection. Connect the probe tip to the probe compensator's signal output connector, then connect the ground clamp to the earth wire of the probe compensator. Enable CH1 and press [AUTO].
2. Observe the shape of the displayed waveform.
 - Overcompensation
 - Correct Compensation
 - Undercompensation

Figure 1-8 Probe compensation calibration

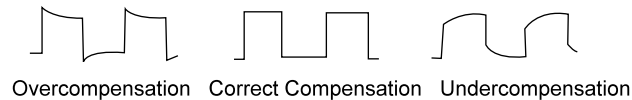

Figure 1-8

3. If you see a “Undercompensation” or “Overcompensation” waveform display, adjust the variable capacitor on the probe with a screwdriver with non-metal handle, until a “Correct Compensation” waveform illustrated above is displayed.

Warning: To avoid electric shock when measuring high voltage with the probe, ensure integrity of the probe’s insulation lead. Do not touch the metal part of the probe when connecting to HV power.

Autoset Waveform Display\

Tenma DSO Series Oscilloscopes feature an autoset function. Your oscilloscope can automatically adjust the vertical deflection factor, scanning time base and trigger mode based on the input signal, until the most appropriate waveform is displayed. The autoset function can only be operated when the signal to be measured is 50Hz or above and the duty ratio is larger than 1%.

Using the Autoset Function:

1. Connect the signal to be measured to the signal input channel.
2. Press [AUTO]. The oscilloscope will automatically set the vertical deflection factor, scanning time base and trigger mode. Should you require to make more detailed check, you can adjust manually after the autoset process until you get the optimum waveform display.

Getting to Know the Vertical System

As shown in the figure below, there are a series of buttons and knobs in the vertical control zone. The following steps will get you familiar with the use of these controls.

Figure 1-9 Vertical control zone on the front panel

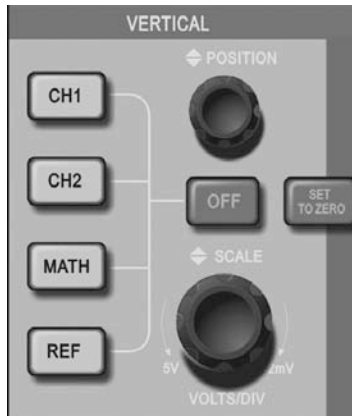

Figure 1-9

1. Turn the vertical position knob to display the signal in the center of the window. The vertical position knob controls the vertical display position of the signal. When you turn the vertical position knob, the sign indicating Ground channel will move up and down with the waveform.

Measurement Tips

If the channel coupling is DC, you can measure the signal's DC% quickly by checking the difference between the waveform and signal ground.

In the case of AC coupling, the DC% within the signal will be filtered. With this coupling mode you can display the DC% of the signal with higher sensitivity.

Shortcut key RETURN TO ZERO for resetting the vertical position of the dual analog channel to zero

This shortcut key can reset vertical shift, horizontal shift and hold off to the zero position (center point).

2. Change the vertical setups and check changes of status information.

You can identify changes of any vertical range by reading the status display column at the lower corner of the waveform window. Turn the vertical scale knob to change the vertical VOLT/DIV range. You will find that the range in the current status column has changed accordingly. Press [CH1], [CH2], [MATH] or [REFERENCE] and the screen will show the corresponding operation menu, sign, waveform and range status information. Press [OFF] to disable the selected channel.

Getting to Know the Horizontal System

As shown in the figure below, there are one button and two knobs in the horizontal control zone. The following steps will get you familiar with horizontal time base setups.

Figure 1-10 Horizontal control zone on the front panel



Figure 1-10

1. Use the horizontal scale knob to change the horizontal time base setup and check any changes in status information. Turn the horizontal scale knob to change the SEC/DIV time base range. You will find that the time base range in the current status column has changed accordingly. Range of horizontal scanning rate is 5ns~50s, in steps of 1-2-5.

*Note: Horizontal scanning time base range of the Tenma DSO Series varies from model to model.

2. Use the horizontal position knob to adjust the horizontal position of the waveform window. The horizontal position knob controls trigger shift of the signal. When this function is used for trigger shift and the horizontal position knob is turned, you will find that the waveform changes with the knob.
3. Press [MENU] to display the ZOOM menu. In this menu press [F3] to activate WINDOW EXPANSION. Then press [F1] to quit WINDOW EXPANSION and return to the MAIN TIME BASE. You can also set the HOLDOFF time with this menu.

Shortcut key for resetting the trigger point shift to horizontal zero position

This shortcut key can quickly return to **RETURN TO ZERO** and reset the trigger point to the vertical center point. You can also turn the horizontal position knob to adjust the horizontal position of the signal in the waveform window.

Definition:

Trigger point means the actual trigger point relative to the center point of the storage device. By turning the horizontal position knob, you can move the trigger point horizontally. Holdoff means reactivating the time interval of the trigger circuit. Turn the multi-function control knob to set the holdoff time.

Getting to Know the Trigger System

As shown by Figure 1-11, there are one knob and three buttons in the trigger menu control zone. The following steps will get you familiar with trigger setups.

Figure 1-11 Trigger menu on the front panel



Figure 1-11

1. Use the trigger level knob to change the trigger level. You will see a trigger sign on the screen that indicates the trigger level. The sign will move up and down with the knob. While you move the trigger level, you will find the trigger level value on the screen changing accordingly.

Shortcut key for resetting the trigger level to zero position

Press 50% to quickly rest the trigger level to zero (channel vertical reference point). At trigger zero you get the highest sensitivity. You can also turn the trigger level knob to reset the trigger point to zero.

2. Open the [TRIGGER MENU] (see the figure below) to change trigger setups.
Press [F1] and select EDGE TRIGGER
Press [F2] and set TRIGGER SOURCE to CH1
Press [F3] and set EDGE TYPE as RISING
Press [F4] and set TRIGGER MODE as AUTO
Press [F5] and set TRIGGER COUPLING as DC

DSO Series User Manual

Figure 1-12 Trigger menu



Figure 1-12

3. Press [50%] and set the trigger level at the vertical center point of the trigger signal amplitude.
4. Press [COMPULSORY] to generate a compulsory trigger signal that is mainly used in the normal and single trigger modes.

You should be familiar with basic operation of the vertical controls, horizontal controls and trigger system menu of your Tenma DSO by now. After reading the last chapter, you should be able to use the menus to set up your oscilloscope. If you are still unfamiliar with these basic operation and methods, please read Chapter 1.

This chapter will guide you through the following:

- Setting up the vertical system ([CH1], [CH2], [MATH], [REFERENCE], [OFF], [VERTICAL POSITION], [VERTICAL SCALING])
- Setting up the horizontal system ([MENU], [HORIZONTAL POSITION], [HORIZONTAL SCALING])
- Setting up the Trigger system ([TRIGGER LEVEL], [MENU], [50%], [COMPULSORY])
- Setting up the sampling method ([ACQUIRE])
- Setting up the display mode ([DISPLAY])
- Save and exit ([SAVE])
- Setting up the help system ([FUNCTION])
- Auto measurement ([MEASURE])
- Cursor measurement ([CURSOR])
- Using the execution buttons ([AUTO], [START/STOP])

Chapter 2 - Instrument Setups

It is recommended that you read this chapter carefully to understand the various measurement functions and system operation of your Tenma DSO Oscilloscope.

Setting up the Vertical System

CH1, CH2 and setups

Each channel has its own vertical menu. You should set up each item for each channel individually. Press the [CH1] or [CH2] function button and the system will display the operation menu for CH1 or CH2. For explanatory notes please see Table 2-1 below:

DSO Series User Manual

Table 2-1: Explanatory notes for channel menu

Function Menu	Setup	Explanatory Note
Coupling	AC DC Ground	Intercept the DC quantities of the input signal. Pass AC and DC quantities of input signal. Disconnect input signal.
Bandwidth limit	On Off	Limit bandwidth to 20MHz to reduce noise display. Full bandwidth.
VOLTS/DIV	Coarse tune Fine tune	Coarse tune in steps of 1-2-5 to set up the deflection factor of the vertical system. Fine tune means further tuning within the coarse tune setup range to improve the vertical resolution.

Function Menu	Setup	Explanatory Note
Probe	1X 10X	Select either one value based on the probe attenuation factor to keep the vertical deflection factor reading correct. There are four values: 1X, 10X, 100X and 1000X.
Invert	On Off	Waveform invert function on. Normal waveform display.

1. Setting up channel coupling

Take an example of applying a signal to CH1. The signal being measured is a sine signal that contains DC quantities.

Press [F1] to select AC. It is now set up as AC coupling. DC quantities of the signal being measured will be intercepted. The waveform display is as follows:

Figure 2-1 DC quantities of the signal are intercepted

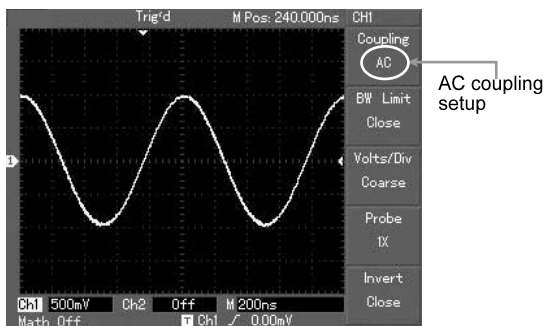

Figure 2-1

Press [F1] to select DC. Both DC and AC quantities of the signal being measured can pass through. The waveform display is as follows:

Figure 2-2 Both DC and AC quantities of the signal are displayed

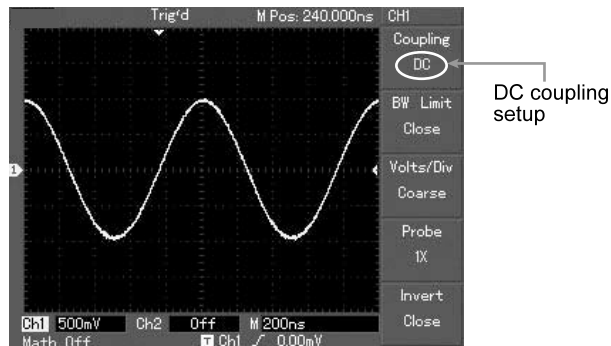

Figure 2-2

DSO Series User Manual

Press [F1] to select GROUND. It is now set up as ground. Both DC and AC quantities contained in the signal being measured will be intercepted. The waveform display is as follows:

(Note: In this mode, although waveform is not displayed, the signal remains connected to the channel circuit)

Figure 2-3 Both DC and AC quantities of the signal are intercepted

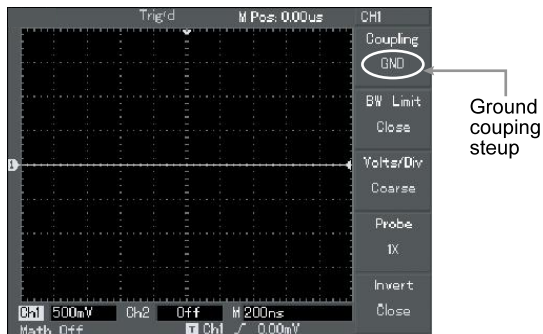

Figure 2-3

2. Setting up the channel bandwidth

Take an example of applying a signal to CH1. The signal being measured is a pulse signal that contains high frequency oscillation.

Press [CH1] to turn CH1 on. Then press [F2] to set BANDWIDTH LIMIT OFF. It is now set up as full bandwidth. The signal being measured can pass through even if it contains high frequency quantities. The waveform display is as follows:

Figure 2-4 Waveform display when bandwidth limit is off

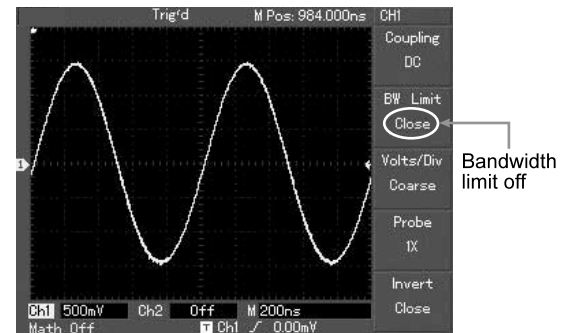

Figure 2-4

Press [F2] to set BANDWIDTH LIMIT ON. All high frequency quantities higher than 20MHz in the signal being measured will be limited. The waveform display is as follows:

Figure 2-5 Waveform display when bandwidth limit is on

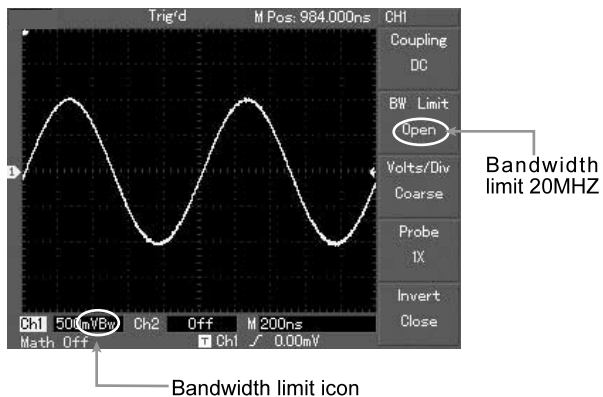

Figure 2-5

3. Setting up the probe rate

To match the PROBE attenuation factor setup, it is necessary to set up the probe attenuation factor in the channel operation menu accordingly. For example, when the probe attenuation factor is 10:1, set the probe attenuation factor at 10X in the menu. Apply this principle to other values to ensure the voltage reading is correct.

The figure below shows the setup and vertical range display when the probe is set at 10:1:

DSO Series User Manual

Figure 2-6 Setting up the probe attenuation factor in the channel menu

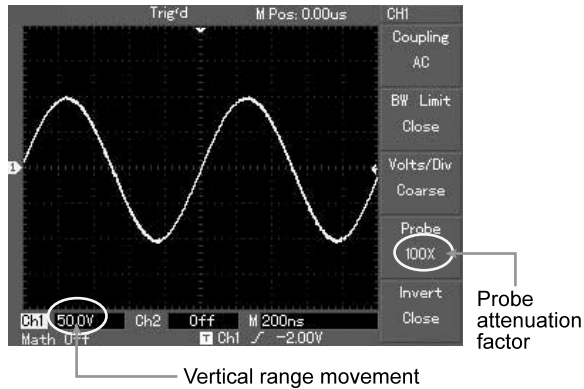

Figure 2-6

4. Vertical VOLTS/DIV adjustment setup

You can adjust the VOLTS/DIV range of the vertical deflection factor either in the coarse tune mode or fine tune mode. In COARSE TUNE mode, the VOLTS/DIV range is 2mV/div~5V/div. Tuning is in steps of 1-2-5. In FINE TUNE mode, you can change the deflection factor in even smaller steps within the current vertical range, so as to continuously adjust the vertical deflection factor within the range of 2mV/div~5V/div without interruption.

Figure 2-7 Coarse tuning and fine tuning the vertical deflection factor

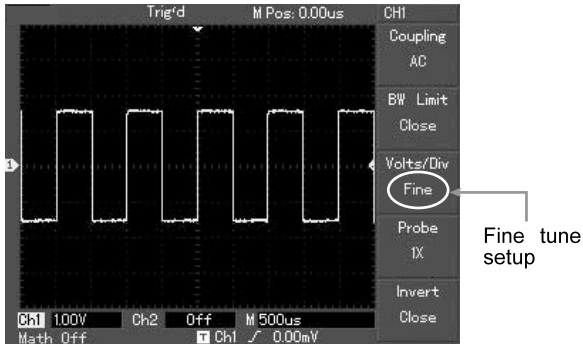

Figure 2-7

5. Waveform inversion setup

Waveform inversion: The displayed signal is inverted 180 degrees with respect to the ground level. Figure 2-8 shows the uninverted waveform. Figure 2-9 shows the inverted waveform.

Figure 2-8 Inversion setup for vertical channel inversion (uninverted)

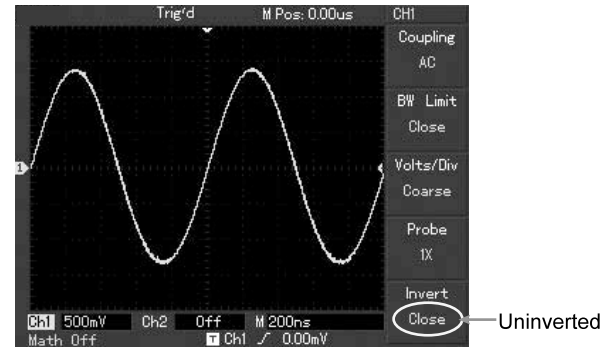

Figure 2-8

DSO Series User Manual

Figure 2-9 Inversion setup for vertical channel inversion (inverted)

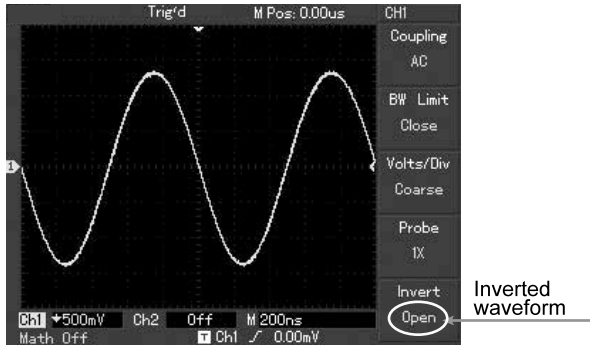

Figure 2-9

I. Operating Math Functions

Math functions are displays of +, -, ×, ÷ and FFT mathematical results of CH1 and CH2. The menu is as follows:

Figure 2-10 Math functions

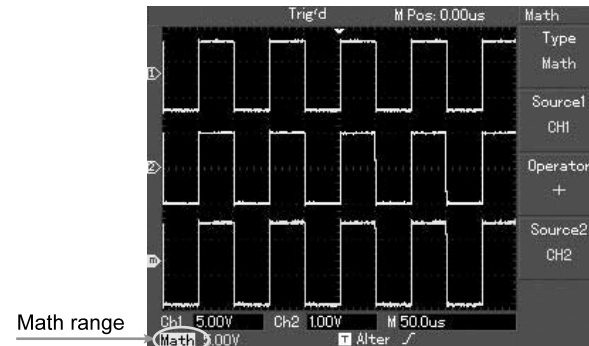

Figure 2-10

Table 2-2 Explanatory notes for the math menu

Function Menu	Setup	Explanatory Note
Type	Math	To carry out +, -, ×, ÷ functions
Signal source 1	CH1 CH2	Set signal source 1 as CH1 waveform Set signal source 1 as CH2 waveform
Operator	+ - × ÷	Signal source 1 + Signal source 2 Signal source 1 - Signal source 2 Signal source 1 × Signal source 2 Signal source 1 ÷ Signal source 2
Signal source 2	CH1 CH2	Set signal source 2 as CH1 waveform Set signal source 2 as CH2 waveform

FFT spectrum analysis

By using the FFT (Fast Fourier Transform) algorithm, you can convert time domain signals (YT) into frequency domain signals. With FFT, you can conveniently observe the following types of signals:

- Measure the harmonic wave composition and distortion of the system
- Demonstrate the noise characteristics of the DC power
- Analyse oscillation

Table 2-3 Explanatory notes for the FFT menu

Function Menu	Setup	Explanatory Note
Type	FFT	To carry out FFT algorithm functions
Signal source	CH1 CH2	Set CH1 as math waveform Set CH2 as math waveform
Window	Hanning Hamming Blackman Rectangle	Set Hanning window function Set Hamming window function Set Blackman window function Set Rectangle window function

How to operate FFT functions

Signals with DC quantities or DC offset will cause error or offset of FFT waveform quantities. To reduce DC quantities, select AC coupling. To reduce random noise and frequency aliasing resulted by repeated or single pulse event, set the acquiring mode of your oscilloscope to average acquisition.

Select the FFT Window

Assuming the YT waveform is constantly repeating itself, the oscilloscope will carry out FFT conversion of time record of a limited length. When this cycle is a whole number, the YT waveform will have the same amplitude at the start and finish. There is no waveform interruption. However, if the YT waveform cycle is not a whole number, there will be different amplitudes at the start and finish, resulting in transient interruption of high frequency at the connection point. In frequency domain, this is known as leakage. To avoid leakage, multiply the original waveform by one window function to set the value at 0 for start and finish compulsively. For application of the window function, please see the table below:

Table 2-4

FFT Window	Feature	Most Suitable Measurement Item
Rectangle	The best frequency resolution, the worst amplitude resolution. Basically similar to a status without adding window.	Temporary or fast pulse. Signal level is generally the same before and after. Equal sine wave of very similar frequency. There is broad-band random noise with slow moving wave spectrum.
Hanning	Frequency resolution is better than the rectangle window, but amplitude resolution is poorer	Sine, cyclical and narrow-band random noise.
Hamming	Frequency resolution is marginally better than Hanning window.	Temporary or fast pulse. Signal level varies greatly before and after.
Blackman	The best amplitude resolution and the poorest frequency resolution.	Mainly for single-frequency signals to search for higher-order harmonic wave.

Definition

FFT resolution means the quotient of the sampling and math points. When math point value is fixed, the sampling rate should be as low as possible relative to the FFT resolution.

Nyquist frequency: To rebuild the original waveform, at least $2f$ sampling rate should be used for waveform with a maximum frequency of f . This is known as Nyquist stability criterion, where f is the Nyquist frequency and $2f$ is the Nyquist sampling rate.

II. Reference Waveform

Display of the saved reference waveforms can be set on or off in the [REF] menu. The waveforms are saved in the non volatile memory of the oscilloscope and identified with the following names: RefA, RefB. To display (recall) or hide the reference waveforms, take the following steps:

1. Press the [REF] menu button on the front panel.

2. Press RefA (RefA reference option). Select the 2. signal source and then select the position of the

signal source by turning the multi-function control knob on the upper part of the front panel. You can choose from 1 to 10. After selecting a numeral for saved waveform, e.g. 1, press the recall button to display the waveform which was originally stored in that position.

If the saved waveform is on the U disk, insert the U disk and then press [F2]. You have two options: DSO/USB. Select USB to recall the saved waveform. The recalled waveform will appear on the screen. After displaying the waveform, press the CANCEL button [F5] to go back to the previous menu.

3. Press RefB (RefA reference option). Select the second signal source for the math function by repeating step 2.

In actual application, when using your Tenma DSO Oscilloscope to measure and observe such waveforms, you can compare the current waveform with the reference waveform for analysis.

Press [REF] to display the reference waveform menu.

Setup is as follows:

Table 2-5 Selecting the storage position

Function Menu	Setup	Explanatory Note
Signal source selection	1~10	1~10 stands for positions of 10 groups of waveforms respectively
Disk	DSO USB	Select an internal storage position Select an external storage position (The U disk must be plugged in)
Close	--	Close the recalled waveform
Recall	--	Recall the selected waveform
Cancel	--	Go back to the previous menu

To select an internal storage position, choose between 1 and 10. In the case of external storage device, plug in the U disk and then press [F2] to select the USB disk.

To save a waveform, see the [SAVE] menu.

Setting up the Horizontal System

Horizontal Control Knob

You can use the horizontal control knob to change the horizontal graticule (time base) and trigger the horizontal position of the memory (triggering position). The vertical center point above the horizontal orientation of the screen is the time reference point of the waveform. Changing the horizontal graticule will cause the waveform to increase or decrease in size relative to the screen center. When the horizontal position changes, the position with respect to the waveform triggering point is also changed.

Horizontal position: Adjust the horizontal positions of channel waveforms (including math waveforms). Resolution of this control button changes with the time base.

Horizontal scaling: Adjust the main time base, i.e. sec/div. When time base extension is on, you can use

DSO Series User Manual

the horizontal scaling knob to change the delay scanning time base and change the window width. For details see notes on time base extension.

Horizontal control knob menu: Display the horizontal menu (see the table below).

Table 2-6

Function Menu	Setup	Explanatory Note
Main time base	--	1. Enable main time base 2. If window extension is enabled, press main time base to disable window extension
--		
Window extension	--	Enable time base
--		
Holdoff		Adjust holdoff time

Figure 2-11 Horizontal system interface



Figure 2-11

Icon definitions

- ① represents the memory position of the current waveform.
- ② represents the memory position of the triggering point.
- ③ represents the position of the triggering point in the current waveform window.
- ④ horizontal time base (main time base), i.e sec/div.
- ⑤ horizontal distance between the triggering position and the window center point.

Definitions

Y-T Mode: In this mode the Y axis indicates voltage and the X axis indicates time.

X-Y Mode: In this mode the X axis indicates CH1 voltage and the Y axis indicates CH2 voltage.

Slow Scanning Mode: When horizontal time base control is set at 50ms/div or slower, the unit will operate in the slow scan sampling mode. When observing low frequency signals in slow scanning mode, it is advised to set the channel coupling as DC.

Sec/Div: A horizontal scaling (time base) unit. If waveform sampling is stopped (by pressing the [RUN/STOP] button), time base control can expand or compress the waveform.

Window Extension

Window extension can be used to zoom in or zoom out a band of waveform to check image details. The window extension setting must not be slower than that of the main time base.

Figure 2-12 Display with the window extended

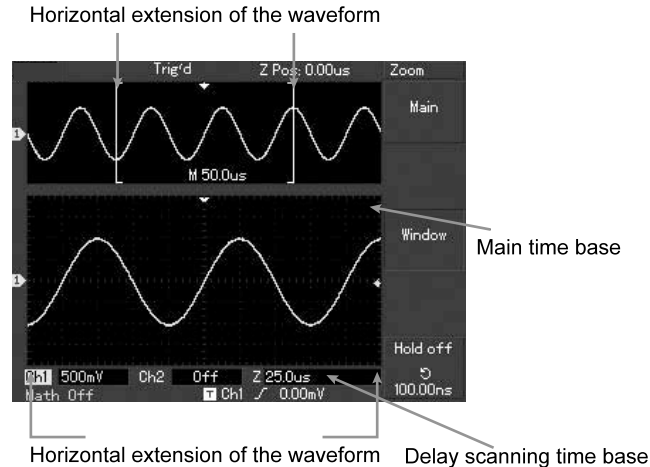

Figure 2-12

In the time base extension mode, the display is divided into two zones as shown above. The upper part displays the original waveform. You can move this zone left and right by turning the horizontal POSITION knob, or increase and decrease the selected zone in size by turning the horizontal SCALE knob.

The lower part is the horizontally extended waveform of the selected original waveform zone. Please note that the resolution of extended time base relative to the main time base is now higher (as shown in the above figure). Since the waveform shown in the entire lower part corresponds to the selected zone in the upper part, you can increase the extended time base by turning the horizontal SCALE knob to decrease the size of the selected zone. In other words, you can increase the multiple of waveform extension.

X-Y Mode

This mode is suitable for CH1 and CH2 only. After selecting the X-Y display mode, the horizontal axis will display CH1 voltage, while the vertical axis will display CH2 voltage.

Figure 2-13 Waveform display in X-Y mode

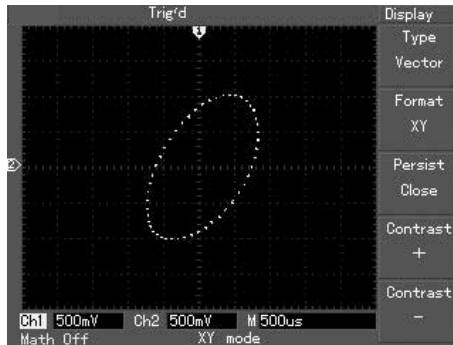

Figure 2-13

Caution: In the normal X-Y mode, the oscilloscope can use the random sampling rate to acquire waveforms. To adjust sampling rate and channel vertical range in the X-Y mode, the omitted sampling rate is 100MS/s. Generally, through adjusting time base range lower, the sampling rate will appropriately result in lissajous figures of better display quality. The following functions have no effect in the X-Y display mode:

- Auto measurement mode
- Cursor measurement mode
- Reference or math waveform
- Vector display type
- Horizontal position knob
- Trigger control

Setting up the Trigger System

Triggering decides when the oscilloscope collects data and display waveforms. Once the trigger is correctly set up, it can convert unstable display into significant waveforms. When beginning to collect data, the oscilloscope first collects sufficient data to draw a waveform on the left of the triggering point. While waiting for the triggering condition to occur, it will

DSO Series User Manual

continuously collect data. When trigger is detected, the oscilloscope will continuously collect sufficient data to draw a waveform on the right of the triggering point. The trigger control zone on the operation panel of your oscilloscope comprises a trigger level adjustment knob, a trigger menu button [MENU], [50%] for setting up the trigger level at the vertical center point of the signal, and a compulsory trigger button [COMPULSORY]

Trigger level: Trigger level sets the signal voltage with respect to the triggering point.

[50%]: Setting the trigger level at the vertical center point of the trigger signal amplitude.

[COMPULSORY]: To generate a compulsory trigger signal. Mainly used in the trigger mode and “Normal” and “Single” modes.

[MENU]: Button for the trigger setup menu

Trigger Control

Trigger modes: edge, pulse, video and alternate

Edge Trigger: When the edge of the trigger signal reaches a given level, trigger occurs.

Pulse Trigger: When the pulse width of the trigger signal reaches a preset trigger condition, trigger occurs.

Video Trigger: Carry out field or line trigger to standard video signals.

Alternate Trigger: Applicable to triggering signals without frequency coherence.

Below are notes for various trigger menus.

Edge Trigger

Edge trigger means triggering at the trigger threshold. When selecting “edge trigger”, you are triggering at the rising and falling edges of the input signal.

Table 2-8

Function Menu	Setup	Explanatory Note
Type	Edge	
Signal source selection	CH1	Set CH1 as the signal source trigger signal
	CH2	Set CH2 as the signal source trigger signal
	EXT	Set the external trigger input channel as the signal source trigger signal
	EXT/5	Set the external trigger source divided by 5 to extend the external trigger level range
	Grid Alternate	Set up as grid trigger CH1, CH2 trigger their own signals alternately
Inclination	Rising Falling	Set to trigger on the signal's rising edge Set to trigger on the signal's falling edge
Trigger mode	Auto Normal Single	Set to sample waveform only if no trigger condition is detected Set to sample waveform only if trigger condition is satisfied Set to sample waveform once when detecting one trigger and then stop
Trigger coupling	DC AC H/F Reject L/F Reject	Intercept DC quantities of the input signal Allow AC and DC quantities of the input signal to pass Reject high frequency quantities above 80kHz of the signal Reject low frequency quantities below 80kHz of the signal

Pulse Trigger

Pulse trigger means determining the triggering time based on the pulse width. You can acquire abnormal pulse by setting the pulse width condition.

Table 2-9 (page 1)

Function Menu	Setup	Explanatory Note
Type	Pulse	
Trigger source	CH1 CH2 EXT EXT/5 Grid Alternate	Set CH1 as the signal source trigger signal Set CH2 as the signal source trigger signal Set the external trigger input channel as the signal source trigger signal Set the external trigger source divided by 5 to extend the external trigger level range Set up as grid trigger CH1, CH2 trigger their own signals alternately
Pulse width condition	Larger Smaller Equal	Trigger when pulse width is larger than default value Trigger when pulse width is smaller than default value Trigger when pulse width equals to default value
Next page 1/2	--	Set the pulse width at 20ns~10s and adjust by turning the control knob on the upper front panel

Table 2-10 (page 2)

Function Menu	Setup	Explanatory Note
Trigger polarity	Positive pulse width Negative pulse width	Set positive pulse width as the trigger signal Set negative pulse width as the trigger signal
Trigger mode	Auto Normal Single	The system automatically samples waveform data when there is no trigger signal input. The scan baseline is shown on the display. When the trigger signal is generated, it automatically turns to trigger scan. The system stops acquiring data when there is no trigger signal. When the trigger signal is generated, trigger scan occurs. One trigger will occur when there is an input trigger signal. Then trigger will stop.
Previous page 2/2	--	Set the pulse width at 20ns~10s and adjust by turning the control knob on the upper front panel

Video Trigger

By selecting video trigger, you can carry out field or line trigger with NTSC or PAL standard video signals. Default trigger coupling is DC. Trigger menus are as follows:

Table 2-11 Video trigger setup

Function Menu	Setup	Explanatory Note
Type	Pulse	
Trigger source	CH1 CH2 EXT EXT/5 Grid Alternate	Set CH1 as the trigger signal Set CH2 as the trigger signal Set the external trigger input channel as the trigger signal Attenuate the external trigger source 5 times as the trigger signal Set grid as the trigger signal Set CH1 and CH2 as alternate trigger signals
Standard	PAL NTSC	Suitable for video signals of low black level Suitable for video signals of high black level
Synchronization	All lines Specified lines Odd field Even field	Set the TV line to synchronize with trigger Set synchronized trigger on the specified line and adjust by turning the control knob on the upper front panel Set the video odd field to synchronized trigger Set the video even field to synchronized trigger

When PAL is selected for STANDARD format and SYNCHRONIZATION mode is LINE, you will see a screen display as shown in Figure 2-14. When SYNCHRONIZATION mode is FIELD, you will see a screen display as shown in Figure 2-15.

Figure 2-14 Video trigger: line synchronization

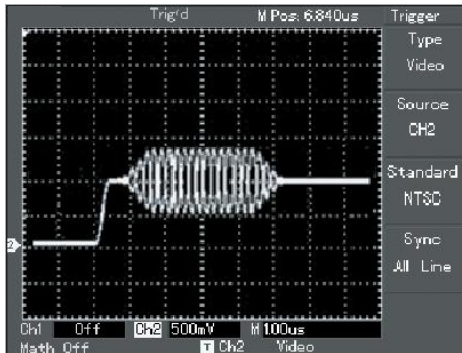

Figure 2-14

Figure 2-15 Video trigger: field synchronization

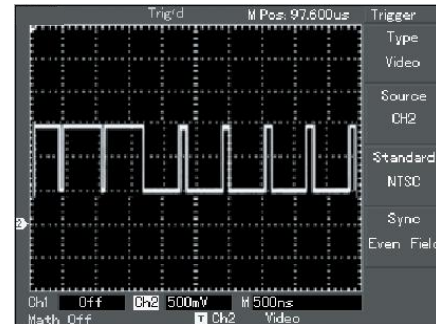

Figure 2-15

DSO Series User Manual

Alternate Trigger

When alternate trigger is selected, the trigger signal will be present in two vertical channels. This triggering mode is suitable for observing two signals of unrelated signal frequencies. The figure below shows the alternate trigger waveform. Trigger menus are listed in Table 2-12.

Figure 2-16 Observing two signals of different frequencies in the alternate trigger mode

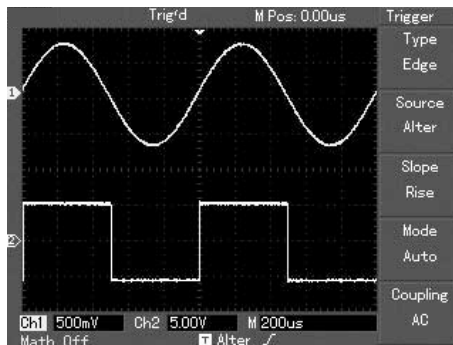

Figure 2-16

Table 2-12 Alternate trigger setup

Function Menu	Setup	Explanatory Note
Type	Edge	Set trigger mode to edge
Trigger source	Alternate	Set CH1 and CH2 to alternate trigger
Inclination	Rising	Set trigger inclination as rising edge
Trigger mode	Auto	Set trigger mode to automatic
Trigger coupling	AC	Set trigger coupling mode to AC

Setup for Trigger coupling mode

Enter the trigger setup menu to set up the trigger coupling mode and achieve the most stable synchronization. The trigger coupling menus are as follows:

Function Menu	Setup	Explanatory Note
Type	Edge	
Trigger source	Alternate	Set CH1 and CH2 to alternate trigger
Inclination	Rising	Set trigger inclination as rising edge
Trigger mode	Auto	Set trigger mode to automatic
Coupling	DC AC H/F Reject L/F Reject	Intercept DC quantities Allow all quantities to pass Intercept high frequency quantities of the signal, only allow low frequency quantities to pass Intercept low frequency quantities of the signal, only allow high frequency quantities to pass

Adjusting the Holdoff Time

You can adjust the holdoff time to observe complicated waveforms (e.g. pulse string series). Holdoff time means the waiting time for the trigger to be ready for use again. During this time the oscilloscope will not trigger until the holdoff is complete. For example, if you wish to trigger one group of pulse series at the first pulse, set the holdoff time to the pulse string width as shown in Figure 2-18. For holdoff menus please see the table below:

Table 2-15

Function Menu	Setup	Explanatory Note
Main time base	--	1. Enable main time base 2. If window extension is enabled, press main time base to disable window extension
Window extension	--	Enable time base extension
--		
Holdoff		Adjust holdoff time

Figure 2-17 Use the holdoff function to synchronize complicated signals

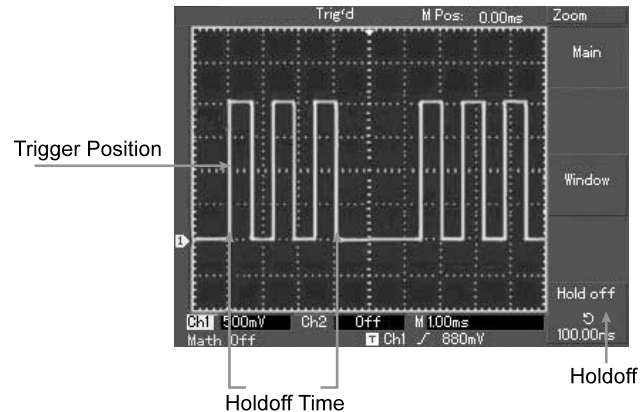

Figure 2-17

Operation

1. Follow the normal signal synchronization procedure and select the edge, trigger source and inclination in the trigger [MENU]. Adjust the trigger level to make the waveform display as stable as possible.
2. Press the key in the horizontal [MENU] to display the horizontal menu.
3. Adjust the multi-function control knob in the upper front panel. The holdoff time will change accordingly until the waveform display is stable.

Definitions

1. Trigger source: Trigger can be obtained from various sources: input channel (CH1, CH2), external trigger (EXT, EXT/5), grid.

■ **Input Channel:** The most common trigger source is input channel (choose either one). The selected trigger source can operate normally whether the input is displayed or not.

■ **External Trigger:** This type of trigger source can trigger in a third channel while acquiring data in two other channels. For example, you can use an external clock or the signal from a circuit to be measured

as the trigger source.

Both EXT and EXT/5 trigger sources use external trigger signals from the EXT TRIG jack. EXT can use the signals directly. You can use EXT within the trigger level range of $-3V$ and $+3V$.

EXT/5 divide the trigger by 5. As a result, trigger range is extended to $-15V$ to $+15V$, enabling the oscilloscope to trigger at a large signal.

■ **Grid:** It means the grid power source. This trigger mode is suitable for observing signals related to the grid

- e.g. the correlation between lighting equipment and power source equipment - to achieve stable synchronization.

2. Trigger mode: Determine the action of your oscilloscope when there is no trigger. This oscilloscope offers three trigger modes for selection: auto, normal and single.

■ **Auto Trigger:** The system will sample waveform data when there is no trigger signal input. The scan baseline is shown on the display. When the trigger signal is generated, it automatically turns to trigger scan for signal synchronization.

Note: When time base of the scan waveform is set to 50ms/div or slower, the Auto mode allows no trigger signal.

■ **Normal Trigger:** In this mode, your oscilloscope samples waveforms only when triggering conditions are met. The system stops acquiring data and waits when there is no trigger signal. When the trigger signal is generated, trigger scan occurs.

■ **Single Trigger:** In this mode, you only have to press the [RUN] button once and the oscilloscope will wait for trigger. When the oscilloscope detects one trigger, it will sample and display the acquired waveform, then stop.

3.Trigger coupling: Trigger coupling determines which quantities of the signal are transmitted to the trigger circuit. Coupling modes are DC, AC, low frequency reject and high frequency reject.

■ **DC:** Allowing all quantities to pass.

■ **AC:** Intercepting DC quantities and attenuating signals under 10Hz.

■ **Low Frequency Reject:** Intercepting DC quantities and attenuating low frequency quantities under 80kHz.

■ **High Frequency Reject:** Attenuating high frequency quantities over 80kHz.

4.Pretrigger/Delayed Trigger: Data sampled before/after triggering.

The trigger position is typically set at the horizontal center of the screen. In this case, you are able to view five divisions of pretrigger and delayed trigger information. Use the horizontal position button to adjust the horizontal shift of the waveform to see more pretrigger information. By observing pretrigger data, you can see the waveform before trigger occurs. For example, you can detect the glitch that occurs when the circuitry starts. Observation and analysis of trigger data can help you identify the cause of glitch.

Setting up the Sampling System

As shown below, [ACQUIRE] button in the control zone is the function key for the sampling system.

Figure 2-18 Function key for the sampling system.



Figure 2-18

Press the [ACQUIRE] button to pop out the sampling setup menu. You can use this menu to adjust the sampling mode.

Table 2-16 Sampling menu

Function Menu	Setup	Explanatory Note
Acquisition mode	Sample Peak detect Average	Turn on the ordinary sampling mode Turn on the peak detect mode Set to average sampling and display the average number of times
Average number of times	2~256	Set the average number of times in multiples of 2, i.e. 2, 4, 8, 16, 32, 64, 128, 256. To change the average number of times, use the multi-function control knob on the left of figure 2-18.
--		
Sampling mode	Real time Equiva- lent	Set sampling to real time Set sampling to equivalent at a time base range of 5ns~100ns/div
--		

DSO Series User Manual

By changing acquisition setup, you can observe the consequent changes in waveform display. If the signal contains considerable noise, you will see the following waveform displays when average sampling is not selected and when 32-time average sampling is selected, see figure 2-19 and 2-20:

Figure 2-19 Waveform without average sampling

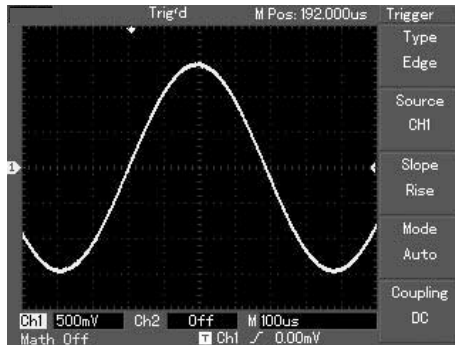

Figure 2-19

Figure 2-20 Waveform when 32-time average sampling is selected

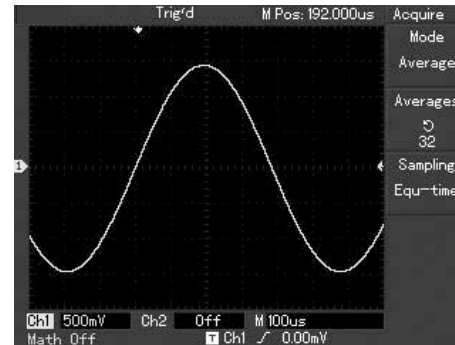

Figure 2-20

Note:

1. Use **Real time sampling** to observe single signals.
2. Use **Equivalent sampling** to observe high frequency cyclical signals.
3. To avoid mixed envelop, select **Peak Detect**.
4. To reduce random noise of the displayed signal, select average sampling and increase the average number of times in multiples of 2, i.e selecting from 2 to 256.

Definitions:

Real time sampling: In this mode, the system makes full acquisition to fill the memory. Maximum sampling rate is 500MS/s. At a setting of 50ns or faster, the oscilloscope will automatically carry out interpolation, i.e. inserting a sampling point between other sampling points.

Equivalent sampling: This is a repeated sampling mode that allows detailed observation of repeated cyclical signals. In the equivalent sampling mode, the horizontal resolution is 40ps higher than the real time mode, i.e. 25 GS/s equivalent.

Sampling mode: The oscilloscope reconstructs the waveform by sampling signals at regular intervals.

Peak detect mode: In this mode, the oscilloscope identifies the maximum and minimum values of the input signals at each sampling interval and use these values to display the waveform. In effect, the oscilloscope can acquire and display narrow pulse which would otherwise be omitted in the sampling mode. Noise seems to be more significant in this mode.

Average mode: The oscilloscope acquires several waveforms and take the average value to display the final waveform. You can use this mode to reduce random noise.

Setting up the Display System

As shown below, the [DISPLAY] button in the control zone is the function key for the display system.

Figure 2-21 Function key for the sampling system (display).



Figure 2-21

Press the [DISPLAY] button to pop out the setup menu shown below. You can use this menu to adjust the display mode.

Table 2-17 Display menu

Function Menu	Setup	Explanatory Note
Display type	Vector dots	Sampling points are linked for display Sampling points are directly displayed
Format	YT XY	Operating mode of the oscilloscope X-Y is the display mode; CH1 is X input, CH2 is Y input
Persist	Off Infinite	The waveform on the screen is refreshed at higher speed The original waveform on the screen remains on display. New data will be added continuously until this function is disabled
Contrast	+, -	Setting the waveform contrast

Key points:

Display Type: Vector display fills the spaces between adjacent sample points. Dots display only the sample points.

Refresh rate: Refresh rate is the number of times the digital storage oscilloscope refreshes the waveform display per second. The refreshing speed affects the capability to observe signal movements

Save and Recall

As shown below, the [SAVE] button in the control zone is the function key for the save system.

Figure 2-22 Function key for the sampling system (save).



Figure 2-22

Press the [SAVE] button to pop out the setup menu shown below. You can use this menu to save or recall waveforms and setup documents stored in the internal memory and USB memory, and to save and recall waveform documents and setup documents in the USB storage device.

Operating Procedure:

1. Press [SAVE] to go to the type menu. There are three types to choose from: waveform, setup and position. Select WAVEFORM to go to the waveform save menu shown below (see Table 2-18), After waveform saving, please go to this chapter II REF (page 34) Menu, see REF operating procedure.
2. Select SETUP to enter the setup save menu (see Table 2-20).
3. Select POSITION to enter the position save menu (see Table 2-21).

Table 2-18 Waveform save menu (page 1)

Function Menu	Setup	Explanatory Note
Type	Waveform	Select the waveform save and recall menu
Signal source	CH1 CH2	Select the waveform from CH1 Select the waveform from CH2
Save position	1~10	Set and select the position in which the waveform is saved in the internal memory. Adjust by turning the multi-function control knob
Save	--	Save the waveform
Next page ½	--	Go to the next page

Table 2-19 Waveform save menu (page 2)

Function Menu	Setup	Explanatory Note
Disk	DSO USB	Select the internal memory of the oscilloscope Select the external USB
Depth	Normal Lengthy	Set normal saving depth of 250 dots Set lengthy saving depth of 2.5k
Previous page 2/2	--	Go back to the previous page

DSO Series User Manual

Table 2-20 Setting save menu

Function Menu	Setup	Explanatory Note
Setup		Select the front panel setup menu
Setup (Save position)	1~10	Maximum 10 front panel setups can be saved. Select with the multi-function control knob on the upper front panel
Save		Save the setting
Recall		Recall the setting
--		

Table 2-21 Position save menu

Function Menu	Setup	Explanatory Note
Position		Select the position menu
--		
Save position	1~10	Maximum 10 position data can be saved. Select with the multi-function control knob on the upper front panel
Recall		Save graph data
--		

Setting up Alternative Functions

As shown below, the [UTILITY] button in the control zone is the function key for alternative functions.

Figure 2-23 Function key for the sampling system (function).



Figure 2-23

Press the [UTILITY] button to pop out the setup menu for alternative system functions.

Table 2-21 (page 1)

Function Menu	Setup	Explanatory Note
Auto calibration	Run Cancel	Run auto calibration Cancel auto calibration and return to the previous page
--		
Recording waveform	See Table 2-23	Setup for recording the waveform
Language	Simplified Chinese Traditional Chinese English	Select the language interface
--		
Next page ½		

DSO Series User Manual

Table 2-22 (page 2)

Function Menu	Setup	Explanatory Note
Factory setup		Setting up factory setup recall
--		
Interface design	Design 1 Design 2 Design 3 Design 4	Setting up the interface designs (colour display) Two designs (mono display)
--		
Previous page 2/2	--	

Table 2-23 Waveform record menu

Function Menu	Setup	Explanatory Note
Record	CH1 CH2	Select CH1 as the recording signal source Select CH2 as the recording signal source
Cancel		Quit the current record menu and return to the previous menu
■ (F3)		Stop recording
▶ (F4)		<ol style="list-style-type: none"> 1. Playback button. 2. When you press this button the system plays back and displays the number of the rewinding screen in the bottom right corner. By turning the multi-function control knob on the upper front panel now, you can suspend playback. Turn the knob further and you can select the waveform of a certain screen to be played back repeatedly. 3. If you wish to continue full playback, press F3 to stop and then press F4. 4. Maximum 1,000 display data can be recorded.
● (F5)	--	Record button. Press this button to record. The number of screens recorded is displayed at the bottom.

Important Points:

Auto Calibration: You can correct measurement errors caused by environmental changes with the auto calibration function. This process can be run selectively when necessary. To make calibration more accurate, power on your oscilloscope and allow 20 minutes to warm up. Then press the [UTILITY] button (alternative functions) and follow the screen instructions.

Choose your language

Your Tenma DSO Series Oscilloscope can be operated in many languages.

To select a display language, press the [UTILITY] menu button and choose your desired language.

Auto Measurement

As shown below, the [MEASURE] button is the function key for auto measurement. Read the following instructions to familiarize with all the powerful

auto measurement functions of your Tenma DSO Series Oscilloscope.

Figure 2-24 Function key for the sampling system (auto measurement).



Figure 2-24

Application Examples

The measurement menu of your oscilloscope is capable of measuring 20 waveform parameters.

Press [MEASURE] to enter the parameter measurement display menu which has 5 zones for simultaneous display of measurement values, assigned to function keys [F1~F5] respectively. When selecting the measurement type of any zone, press the corresponding function key to enter the type option menu.

The measurement type option menu lets you choose voltage or time. You can enter the voltage or time measurement by pressing [F1~F5] for the corresponding type, and then return to the measurement display menu. You can also press [F5] and select [ALL PARAMETERS] to show all measurement parameters of both voltage and time. Press [F2] to select the channel (measurement is carried out only when the channel is enabled). If you do not wish to change the current measurement type, press [F1] to return to the parameter measurement display menu.

Example 1: To display the measurement peak-to-peak value of CH2 in the [F1] zone, follow the steps below:

1. Press [F1] to enter the measurement type option menu.
2. Press [F2] to select channel 2 (CH2).
3. Press [F3] to select voltage.
4. Press [F5] (1/4 next page) and you will see the peak-to-peak value at position [F3].
5. Press [F3] to select peak-to-peak value and then automatically return to the parameter measurement display menu.

On the first page of the measurement menu, peak-to-peak value is displayed in zone [F1].

Example 2: Setup for delayed measurement. You can use the delayed measurement function to measure the time interval between the rising edge of the two signal sources, i.e. the time interval between the rising edge of the first cycle of a certain signal source and the rising edge of the first cycle of another signal source. Measure as follows:

DSO Series User Manual

1. In the measurement menu, select the display zone for delayed measurement value as in the above examples (time type page 3/3).
2. Press [F2] to enter the delay menu.
3. Select reference signal source: CH1, and then select the delay signal source: CH2.
4. Press [F5] to confirm. The delayed measurement is now displayed in your specified zone.

Automatic measurement of voltage parameters

Your Tenma DSO Series Oscilloscope can automatically measure the following voltage parameters: peak-to-peak value, maximum value, minimum value, average value, root mean square value, top value and base value. Definitions of these parameters are as follows:

Peak-to-peak value (Vpp): The voltage value from the highest point to lowest point of the waveform.

Maximum value (Vmax): The voltage value from the highest point to ground (GND) of the waveform.

Minimum value (Vmin): The voltage value from the lowest point to ground (GND) of the waveform.

Amplitude value (Vamp): The voltage value from top to base of the waveform.

Top value (Vtop): The voltage value from the level top to ground (GND) of the waveform.

Base value (Vbase): The voltage value from the level base to ground (GND) of the waveform.

Overshoot: The ratio value of the difference between maximum value and top value of the waveform to the amplitude value.

Preshoot: The ratio value of the difference between minimum value and base value of the waveform to the amplitude value.

Average value: Average amplitude of signals within 1 cycle.

Root mean square value (Vrms): The effective value.

Energy generated by AC signal conversion during 1 cycle with respect to the DC voltage that produces equivalent energy, i.e. root mean square value.

Automatic measurement of time parameters

Your Tenma DSO Series Oscilloscope can automatically measure the signal frequency, cycle, rise time, fall time, positive pulse width, negative pulse width, delay 1→2(rising edge), delay 1→2(falling edge), positive duty ratio, negative duty ratio. Definitions of these parameters are as follows:

Rise Time: The time taken by the waveform to rise from 10% to 90%.

Fall Time: The time taken by the waveform to fall from 90% to 10%.

Positive pulse (+Width): pulse width of positive pulse at 50% amplitude.

Negative pulse (-Width): pulse width of negative pulse at 50% amplitude.

Delay 1→2 (Rising edge): Delayed time of the rising edge of CH1, CH2.

Delay 1→2 (Falling edge): Delayed time of the falling edge of CH1, CH2.

Positive duty ratio (+Duty): Ratio of positive pulse width to cycle.

Negative duty ratio (-Duty): Ratio of negative pulse width to cycle.

Measurement menu

Operation: Press [MEASURE] to display the zones for 5 measurement values. You can press any one of F1~F5 to enter the measurement option menu, as shown in Table 2-24.

DSO Series User Manual

Table 2-24

Function Menu	Setup	Explanatory Note
Return		Return to the parameter measurement display menu
Signal source	CH1	Select the channel for parameter measurement
	CH2	Select the channel for parameter measurement
Voltage type		Enter the voltage type parameter menu
Time type		Enter the time type parameter menu
All parameters		Display/close all measurement parameters

Voltage type menus are shown in Table 2-25 to Table 2-28.

Table 2-25

Function/Measurement	Explanatory Note
Return	Return to the menu shown in Table 2-24
Preshoot	Select to return to the parameter measurement display menu and replace the original parameter in that position
Amplitude	Ditto
Overshoot	Ditto
Next page (1/4)	Turn page

Table 2-26

Function/Measurement	Explanatory Note
Previous page	Return to the previous page
Average value	Select to return to the parameter measurement display menu and replace the original parameter in that position
Peak-to-peak value	Ditto
Root mean square value	Ditto
Next page (2/4)	Turn page

Table 2-27

Function/Measurement	Explanatory Note
Previous page	Return to the previous page
Top value	Select to return to the parameter measurement display menu and replace the original parameter in that position
Base value	Ditto
Mean value	Ditto
Next page (3/4)	Turn page

DSO Series User Manual

Table 2-28

Function/Measurement	Explanatory Note
Previous page	Return to the previous page
Maximum value	Select to return to the parameter measurement display menu and replace the original parameter in that position
Minimum value	Ditto
Next page (4/4)	Return to page 1 (as shown in Table 2-25)

Time type menus are shown in Table 2-29 to Table 2-31

Table 2-29

Function/Measurement	Explanatory Note
Return	Return to the menu shown in Table 2-24
Frequency	Select to return to the parameter measurement display menu and replace the original parameter in that position
Amplitude	Ditto
Rise Time	Ditto
Next page (1/3)	Turn page

Table 2-30

Function/Measurement	Explanatory Note
Previous page	Return to the previous page
Fall Time	Select to return to the parameter measurement display menu and replace the original parameter in that position
Positive pulse width	Ditto
Negative pulse width	Ditto
Next page (2/3)	Turn page

Table 2-31

Function/Measurement	Explanatory Note
Previous page	Return to the previous page
Delay	Select to return to the delay option menu (as shown in Table 2-31a)
Positive duty ratio	Select to return to the parameter measurement display menu and replace the original parameter in that position
Negative duty ratio	Ditto
First page (3/3)	Return to page 1 (as shown in Table 2-29)

Table 2-31a

Function Menu	Setup	Explanatory Note
Channel	CH1/CH2 /MATH	Select the measurement channel
Channel	CH1/CH2 /MATH	Select the reference channel
Confirm		Select to return to the parameter measurement display menu and replace the original parameter in that position

Cursor Measurement

Press [CURSOR] to display the measurement cursor and cursor menu, then adjust the cursor position by turning the multi-function control knob. As shown in the figure below, [CURSOR] in the control zone is the function key for cursor measurement.

Figure 2-25 Function key for the sampling system (cursor)



Figure 2-25

You can move the cursor to carry out measurement in the [CURSOR] mode. There are three modes to choose from: voltage, time and tracking. When measuring voltage, press [SELECT] and [COARSE TUNE] on the front panel. Positions of the two cursors can be adjusted with the multi-function control knob to measure ΔV . Likewise, by selecting time, you can measure ΔT . In the tracking mode and waveform display is on, you can see the cursor tracking the changing signal automatically.

1. Measuring voltage/time: Cursor 1 or cursor 2 will appear simultaneously. Adjust their positions on the screen with the multi-function control knob and select which cursor to adjust with the [SELECT] button. The displayed reading is the voltage or time value between the two cursors.
2. Tracking mode: Horizontal and vertical cursors cross to form a cross-shaped cursor. It automatically positions itself on the waveform. You can adjust the horizontal position of the cross cursor in the waveform by turning the multi-function control knob. Your oscilloscope will also display the coordinate of the cursor point.

3. When the cursor function is enabled, measurement value is automatically displayed in the upper right hand corner.

Using the Run Button

There is a button on the top right hand corner on the front panel: [RUN/STOP]. When this button is pressed and a green indicator lights up, your oscilloscope is in a running status. If a red light comes on after pressing this button, it indicates the unit has stopped operating.

Figure 2-26 RUN/STOP button



Figure 2-26

Auto Setup

As shown above, **Auto Setup** can simplify operation. Press [AUTO] and the oscilloscope can automatically adjust the vertical deflection factor and horizontal time base range according to the amplitude and frequency of the waveform, and ensure stable display of the waveform. When the oscilloscope is in auto setup mode, the system setups are as follows:

Table 2-32

Function Menu	Setup
Acquisition mode	Adjust to "Sampling" or "Peak Measurement"
Cursor	Disabled
Display format	Set to YT
Display type	Vector
Horizontal position	Adjusted
SEC/DIV	Adjust according to signal frequency
Trigger coupling	AC
Trigger Holdoff	Minimum value
Trigger level	Set at 50%
Trigger mode	Auto
Trigger source	Set to CH1 but if there is no signal in CH1 and CH2 applies a signal, it will set to CH2
Trigger inclination	Rising
Trigger type	Edge
Vertical bandwidth	Full
VOLT/DIV	Adjust according to amplitude of the signal
Vertical coupling	DC

RUN/STOP: Acquire waveform continuously or stop acquisition.

If you want the oscilloscope to acquire waveform continuously, press [RUN/STOP] once. Press the button again to stop acquisition. You can use this button to switch between acquiring and stop acquiring waveform. In the Run mode, a green light comes on and AUTO appears on the screen. In the STOP mode, a red light comes on and STOP appears on the screen.

Chapter 3- Practical Example Scenarios

Scenario 1: Measuring simple signals

To observe and measure an unknown signal, and to quickly display and measure the signal's frequency and peak-to-peak value.

1. To quickly display this signal, follow the steps below:

- ①. In the probe menu, set the attenuation factor to 10X and set the switch on the probe to 10X.
- ②. Connect the CH1 probe to the circuitry to be measured.
- ③. Press [AUTO].
The oscilloscope will carry out auto setup to optimise waveform display. In this status, you can further adjust the vertical and horizontal range until you get the desired waveform display.

2. Automatic measurement of signal voltage and time parameters

Your oscilloscope can automatically measure most display signals. To measure signal frequency and peak-to-peak value, follow the steps below:

- ① .Press [MEASURE] to display the auto measurement menu.
- ② .Press [F1] to enter the measurement type option menu.
- ③ .Press [F3] to select voltage.
- ④ .Press [F5] to go to page 2/4, then press [F3] to select measurement type: peak-to-peak value.
- ⑤ .Press [F2] to enter the measurement type option menu, then press [F4] to select time.
- ⑥ .Press [F2] to select measurement type: frequency.

Peak-to-peak value and frequency measurement values are now displayed in positions [F1] and [F2] respectively.

Figure 3-1 Auto measurement

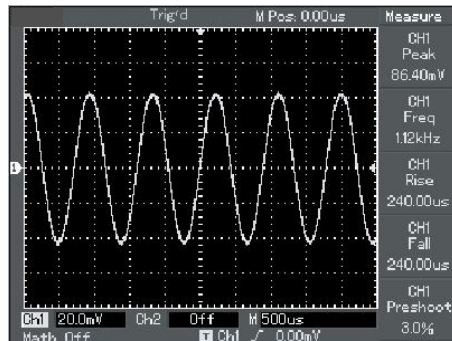

Figure 3-1

Scenario 2: Observing the delay caused by a sine wave signal passes through the circuit

As in the previous scenario, set the probe attenuation factor of the probe and oscilloscope channel to 10X. Connect the CH1 to the circuit signal input terminal. Connect CH2 to the output terminal.

Steps:

1. Display the signals in CH1 and CH2.

- ① .Press [AUTO].
- ② .Continue to adjust the horizontal and vertical range until you get the desired waveform display.
- ③ .Press [CH1] to select CH1. Adjust vertical position of the CH1 waveform by turning the vertical position control knob.
- ④ .Press [CH2] to select CH2. In the same way described in ①, adjust vertical position of the CH2 waveform so that the waveforms of CH1 and CH2 do not overlap. This will make observation easier.

2.Measure the delay caused by a sine wave signal passes through the circuit and observing waveform changes.

- ① .When measuring channel delay automatically:
Press [MEASURE] to display the auto measurement menu.
Press [F1] to enter the measurement type option menu.
Press [F4] to enter the time measurement parameters table.
Press [F5] twice to go to page 3/3.
Press [F2] to select delayed measurement.
Press [F1], select CH1 and then press [F2] to select moving to CH2, then press [F5] to confirm.
You can see the delay value below “CH1-CH2 delay” in the [F1] zone now.
- ② .Observe waveform changes (see the figure below)

Figure 3-2 Waveform delay

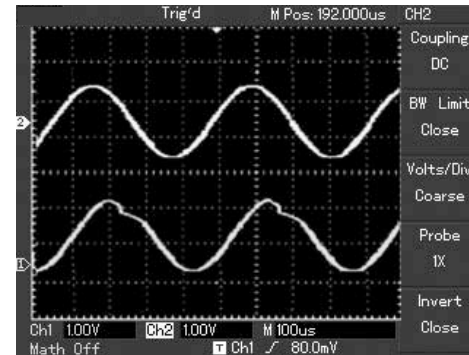

Figure 3-2

Scenario 3: Acquiring single signal

The advantage and special feature of your digital storage oscilloscopes lie in its ability to acquire non cyclical signals like pulse and glitch. To acquire a single signal, you must have transcendental knowledge of that signal to set the trigger level and trigger edge. For example, if the pulse is a logical signal of TTL level, the trigger level should be set at about 2V and the trigger edge should be set to rising edge trigger. If you are not certain about the signal, you can observe it by automatic or normal trigger to determine the trigger level and trigger edge.

Steps:

1. As in the previous scenario, set the attenuation factor of the probe and CH1.
2. Carry out trigger setup
 - ① .Press [MENU] in the trigger control zone to display the trigger setup menu.
 - ② .In this menu, use [F1~F5] menus to set the trigger type to EDGE, set trigger source to CH1, set inclination to RISING, set trigger mode to SINGLE and set trigger coupling to AC.

- ③ .Adjust horizontal time base and vertical range to an appropriate range.
- ④ .Turn the [TRIGGER LEVEL] control knob to get the desired level.
- ⑤ .Press [RUN/STOP] and wait for a signal that meets the trigger condition. If any signal reaches the set trigger level, the system will sample once and display it on the screen. By using this function you can easily acquire any occasional event. For example, when a sudden glitch of relatively big amplitude is acquired: set the trigger level to just higher than the normal signal level. Press [RUN/STOP] and begin waiting. When a glitch occurs, the machine will automatically trigger and record the waveform immediately before and after triggering. By turning the horizontal position knob in the horizontal control zone on the front panel, you can change the trigger position horizontally to achieve negative delay trigger of various lengths for easy observation of waveform occurring before the glitch.

Figure 3-3 Single signal

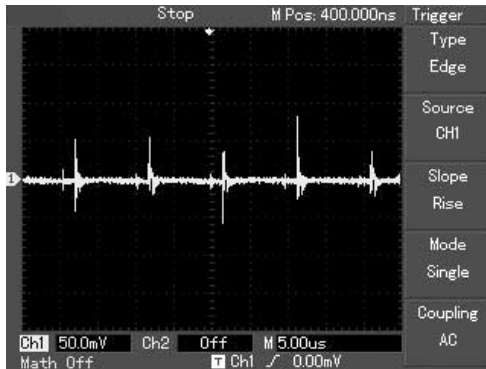

Figure 3-3

Scenario 4: Reducing random noise of signals

If the signal being measured is stacked with random noise, you can adjust the setups of your oscilloscope to filter or reduce the noise, so it will not cause interference to the signal during measurement. (Waveform is show below)

Figure 3-4 Reducing random noise of signals

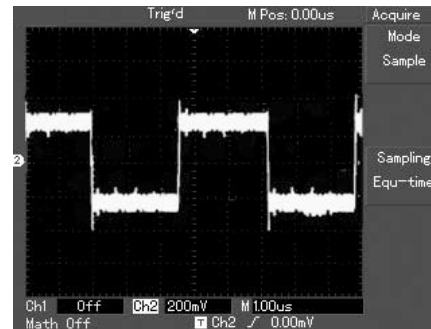

Figure 3-4

Steps:

1. As in the previous scenario, set the attenuation factor of the probe and CH1.

2. Connect the signal to ensure stable display of waveform. See the previous scenario for operation instruction. See the previous chapter for guidance on adjusting the horizontal time base and vertical range.

3. Improving trigger by setting trigger coupling.

(1). Press [MENU] in the trigger zone to display the trigger setup menu.

(2). Set TRIGGER COUPLING to LOW FREQUENCY SUPPRESSION or HIGH FREQUENCY SUPPRESSION. By selecting low frequency suppression a high-pass filter is set up. It filters low frequency signal quantities under (lower than) 80kHz and allows high frequency signal quantities to pass through. If you select high frequency suppression a low-pass filter is set up. It filters high frequency signal quantities higher than 80kHz and allows low frequency signal quantities to pass through. By setting LOW FREQUENCY SUPPRESSION or HIGH FREQUENCY SUPPRESSION, you can suppress low

frequency or high frequency noise respectively and achieve a stable trigger.

4. Reducing display noise by setting the sampling mode.

① .If the signal being measured is stacked with random noise and the waveform is too coarse as a result, you can use the average sampling mode to eliminate random noise display and reduce the size of waveform for easy observation and measurement. After getting the mean, random noise is reduced and details of the signal are clearer. Follow the steps below:

Press [ACQUIRE] in the menu zone of the front panel to display the sampling setup menu. Press menu operation key [F1] to set acquisition mode to MEAN, then press menu operation key [F2] to adjust the average number of times in multiples of 2, i.e. 2 to 256, until you get the desired waveform display that meets observation and measurement requirements. (See the figure below)

Figure 3-5 Signal noise suppressed

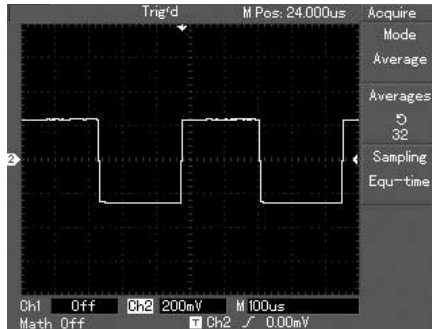

Figure 3-5

② . You can also lower the waveform brightness to reduce display noise.

Caution: In the average sampling mode the waveform display will update at a slower rate. This is normal.

Scenario 5: Using cursors for measurement

Your oscilloscope can measure 20 waveform parameters automatically. All auto measurement parameters can be measured with the cursors. By using cursors, you can quickly measure the time and voltage of a waveform.

Measuring the frequency of Sinc first peak

To measure the Sinc frequency of the signal rising edge, follow the steps below:

1. Press [CURSOR] to display the cursor measurement menu.
2. Press menu operation key [F1] to set cursor type to TIME.
3. Turn the multi-function control knob to set cursor 1 at the Sinc first peak.
4. Press [SELECT] to select the cursor, then turn the multi-function control knob again to set cursor 2 at the Sinc's second peak.

The cursor menu will automatically display the $1/\Delta T$ value, i.e. the frequency of that point. See the figure below.

Note: When using the cursor to measure voltage, follow step 2 only and set the cursor type to VOLTAGE.

Figure 3-6 Cursor measurement of signal frequency

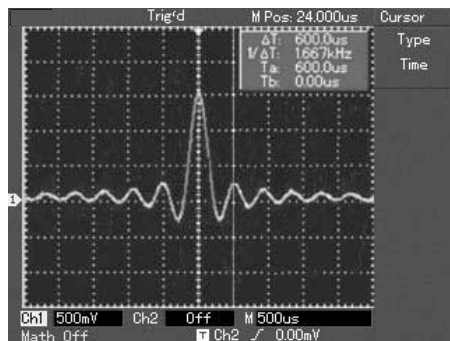

Figure 3-6

Scenario 6: Using the X-Y function

To check the phase difference between two channels.

Example: To measure the phase variation when a signal passes through the circuit, connect your oscilloscope to the circuit and monitor the input and output signals.

To check the circuit's input and output in the X-Y coordinate graph, follow the steps below:

1. Set the attenuation factor of the probe to 10X. Set the switch of the probe to 10X.
2. Connect the CH1 probe to the input terminal of the network. Connect the CH2 probe to the output terminal of the network.
3. If the channel is not displayed, press the [CH1] and [CH2] menu button to enable the two channels.
4. Press [AUTO].
5. Adjust the vertical scaling knob to make the displayed amplitude of the two channels to about equal.
6. Press the [DSIPLAY] menu key in the horizontal control zone to recall the horizontal control menu.

7. Press [F2] to select X-Y. The oscilloscope will display the circuit's input and output characteristics in a Lissajous figure.
8. Adjust the vertical scale and vertical position knob to achieve the best waveform result.
9. Using the elliptic oscilloscope display graph to observe, measure and calculate the phase difference. (see the figure below)
The signal must be in the center

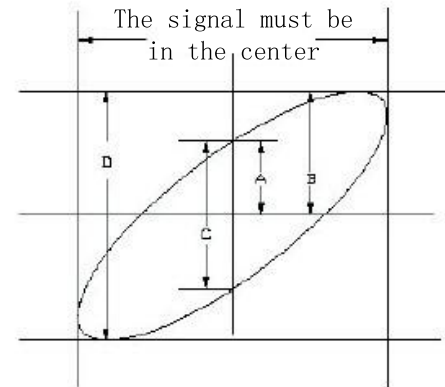

Figure 3-7

If $\sin\theta = \frac{A}{B}$ or $\frac{C}{D}$,

θ is the angle of disparity between the channels. For definitions of A,B,C,D see the above figure. Calculating with this formula, the angle of disparity is

$$\theta = \pm \arcsin\left(\frac{A}{B}\right) \text{ or } \theta = \pm \arcsin\left(\frac{C}{D}\right)$$

If the ellipse's main axis is within quadrants I and III, the angle of disparity should be within quadrant $\frac{(0 \sim \pi)}{2}$ or $\frac{(3\pi \sim 2\pi)}{2}$

If the main axis is within quadrants II and IV, the angle of disparity should be within quadrants II and III, i.e. inside $\frac{(\pi \sim \pi)}{2}$ or $\frac{(\pi \sim 3)}{2}$

Furthermore, if the frequencies and phase differences of two signals being measured are whole multiples, you can calculate the frequency and phase correlation between the two signals.

10: Table of X and Y phase difference

Signals' frequency ratio	Phase difference					
	0 degree	45 degree	90 degree	180 degree	270 degree	360 degree
1:1	/	o	○	\	○	/

Scenario 7: Video signal triggering

To observe a video circuit, use the video trigger function to obtain a stable display of video output signal.

Video field triggering

To trigger in the video field, follow the steps below:

1. Press [MENU] in the trigger control zone to display the trigger menu.
2. Press menu operation key [F1] to select the type to VIDEO.
3. Press menu operation key [F2] to set trigger source to CH1.
4. Press menu operation key [F3] to select PAL as the video standard.
5. Press menu operation key [F4] to select ODD FIELD or EVEN FIELD synchronization.
6. Turn the horizontal scaling knob in the horizontal control zone to adjust horizontal time base for a clear waveform display.

Figure 3-8 Video field triggering

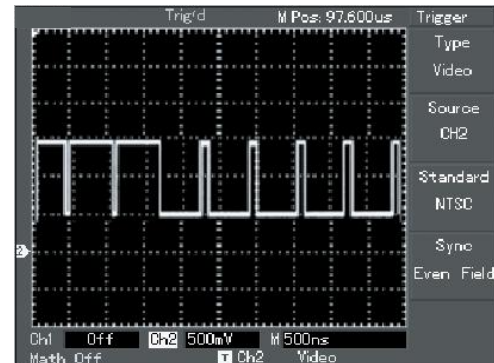

Figure 3-8

Video line triggering

To trigger on the video line, follow the steps below:

1. Press [TRIGGER] [MENU] button in the trigger control zone to display the trigger menu.
2. Press menu operation key [F1] to select VIDEO.
3. Press menu operation key [F2] to set trigger source to CH1.
4. Press menu operation key [F3] to select PAL as the video standard.
5. Press menu operation key [F4] to select LINE synchronization.
6. Use the multi-function control knob to select triggering on any line.
7. Turn the horizontal scaling knob in the horizontal control zone to adjust horizontal time base for a clear waveform display.

Figure 3-9 Video line triggering

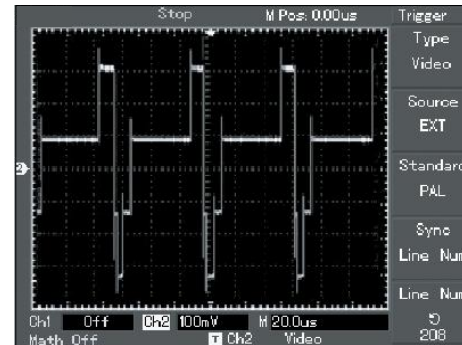

Figure 3-9

Definitions of System Prompts

Adjustment at Ultimate Limit: This informs you that in the control knob has reached its adjustment limit in the current status. No further adjust is possible. When the vertical deflection factor ON/OFF, time base ON/OFF, X shift, vertical shift and trigger level adjustments have reached their ultimate limits, this prompt will appear.

USB Drive Connected: After a USB drive is plugged into the oscilloscope, this prompt appears when the connection is valid.

USB Drive Disconnected: After a USB drive is unplugged from the oscilloscope, this prompt appears.

Saving: When the oscilloscope is saving a waveform, this prompt is show on the screen. A progress bar appears at the bottom.

Loading: When recalling a waveform, this prompt is show on the screen. A progress bar appears at the bottom.

Troubleshooting

① .If the screen of your oscilloscope remains black without any display after powering on, follow the steps

Chapter 4 --- System Prompts and Trouble-shooting

below to find the cause:

- ② . Check the power cable connection and check if there is normal power supply.
- ③ . Check if the power switch is properly pressed.
- ④ . Restart the unit after performing the above checks.
- ⑤ . If the unit still fails to power on, contact TENMA to request service.

2.If no waveform is displayed after you have acquired a signal, follow the steps below to find the cause:

- ① . Check whether the probe is properly connected to the signal lead.
- ② . Check whether the signal lead is properly connected to the BNC (channel adaptor).
- ③ . Check whether the probe is connected properly to the object for measurement.
- ④ . Check whether the object for measurement is generating signals (connect the channel with signals to the questionable channel to find the cause).
- ⑤ . Restart the acquisition process.

3. The measurement voltage amplitude value is 10 times larger or smaller than the actual value:
Check if the channel attenuation factor corresponds with the probe attenuation you have chosen.
4. There is waveform display but it is not stable:
- ① . Check the TRIGGER SOURCE setup in the trigger menu. See whether it is the same as the actual signal input channel.
 - ② . Check the trigger type: Use EDGE TRIGGER for ordinary signals and VIDEO TRIGGER for video signals. Stable waveform display is achieved only when the correct trigger mode is selected.
 - ③ . Try changing the COUPLING display to HIGH FREQUENCY SUPPRESSION or LOW FREQUENCY SUPPRESSION to filter any high or low frequency noise that is interfering with triggering.
5. No display after pressing [RUN/STOP]:
- ① . Check if the TRIGGER MODE is set to NORMAL or SINGLE in the menu, and whether the level exceeds the waveform range.
If so, move the level to the center or set TRIGGER MODE to AUTO.
 - ② . Press [AUTO] to complete the setup.

6. Display speed is slower after average sampling time is enabled:

- ① . If average sampling is carried out for more than 32 times, the display speed will drop. This is normal.
 - ② . You can reduce the intervals of average sampling.
7. Waveform display in ladder shape:
- ① . This is normal. The reason is possibly horizontal time base range is too low. You can improve horizontal resolution and enhance the display quality by increasing the horizontal time base.
 - ② . If the display type is VECTOR, the connection between sampling dots may cause a ladder shaped waveform. Set the display type to DOT to solve this problem.

Chapter 5 - Appendixes

Appendix A: Technical Indicators

Unless otherwise specified, all technical specifications apply to probes with an attenuation setting of 10X and the Tenma DSO Series Digital Oscilloscopes. To verify that your oscilloscope meets specifications, it must first meet the following conditions:

- The oscilloscope must have been operating continuously for thirty minutes within the specified operating temperature.
- If the operating temperature changes by more than 5 °C, you must perform the Self Cal operation, accessible through the System Functions menu. All specifications are guaranteed unless noted “typical”.

Technical Indicators

Sampling		
Sampling modes	Real time	Equivalent
Sampling rates	500MS/s	25GS/s
Average value	When all channels have made N samplings simultaneously, N is selectable from 2, 4, 8, 16, 32, 64, 128 and 256.	

Input	
Input coupling	DC, AC, GND
Input impedance	1 ±2% MΩ in parallel with 24 pF ±3 pF
Probe attenuation	1X, 10X, 100X, 1000X
Maximum input voltage	400V (DC + AC Peak, 1 MΩ input impedance)
Time delay between channels (Typical)	150ps

Horizontal	
Waveform interpolation	Sin (x) / x
Record length	1024k
Scanning range (s/div)	2ns/div-50s/div (150MHz, 200MHz) 5ns/div-50s/div (100MHz, 60MHz, 40MHz) 20ns/div-50s/div (25MHz) At 1-2-5 increment
Accuracy of sampling rate and delay time	±100ppm (any time interval ≥1ms)
Time interval (ΔT) measurement accuracy (full bandwidth)	Single: ± (1 sampling time interval + 100ppm X reading + 0.6ns) > 16 average values: ± (1 sampling time interval + 100ppm x reading + 0.4ns)

Vertical	
A/D converter	8-bit resolution, two channels sampled simultaneously
Deflection factor VOLTS/DIV Range	2 mV/div ~ 5 V/div at input BNC
Position range	$\geq \pm 10$ div
Analog bandwidth	200MHz, 150MHz, 100MHz, 60MHz, 40MHz, 25MHz
Single bandwidth	100MHz, 100MHz, 100MHz, 60MHz, 40MHz, 25MHz
Selectable analog bandwidth limit (Typical)	20MHz
Low frequency response (AC coupling, -3dB)	≥ 10 Hz at BNC
Rise time (at BNC, typical)	$\leq 1.8\text{ns}$, $\leq 2.3\text{ns}$, $\leq 3.5\text{ns}$, $\leq 5.8\text{ns}$, $\leq 8.7\text{ns}$, $\leq 14\text{ns}$, at 200MHz, 150MHz, 100MHz, 60MHz, 40MHz and 25MHz bandwidths respectively
DC gain accuracy	When vertical sensitivity is 2mV/div, 5mV/div: $\pm 4\%$ (sample or average sampling mode); When vertical sensitivity is 10mV/div~5V/div: $\pm 3\%$ (sample or average sampling mode).
DC measurement accuracy (average sampling mode)	When vertical position is zero and $N \geq 16$: $\pm (4\% \times \text{reading} + 0.1 \text{ div} + 1\text{mV})$ and 2mV/div or 5mV/div is selected; $\pm (3\% \times \text{reading} + 0.1 \text{ div} + 1\text{mV})$ and 10mV/div~5V/div is selected. When vertical position is not zero and $N \geq 16$: $\pm (3\% \times (\text{reading} + \text{vertical shift reading}) + (1\% \times \text{vertical shift reading})) + 0.2\text{div}$. Set from 2mV/div to 200mV/div plus 2mV; Setup value > 200mV/div to 5V/div plus 50mV.
Voltage difference (ΔV) measurement accuracy (average sampling mode)	Under identical setup and environmental conditions, the voltage difference (ΔV) between two points of the waveform after the average of ≥ 16 waveforms acquired waveforms is taken: $\pm (3\% \times \text{reading} + 0.05 \text{ div})$

Trigger		
Trigger sensitivity	± 1 div	
Trigger level range	Internal	± 5 div from the center of the screen
	EXT	± 3V
	EXT/5	± 15V
Trigger level accuracy (Typical) applied on signals of ≥20ns rise or fall time	Internal	± (0.3 div x V/div) (within ± 4 div from the center of the screen)
	EXT	± (6% default value + 40mV)
	EXT/5	±(6% default value + 200mV)
Trigger capability	Normal mode/scanning mode, pretrigger/delayed trigger. Pretrigger depth is adjustable	
Holdoff range	100ns – 1.5s	
Set level to 50% (Typical)	Input signal frequency ≥50Hz	
Edge Trigger		
Edge type	Rise, Fall	
Pulse Trigger		
Trigger mode	(Less than, greater than, or equal) positive pulse; (Less than, greater than, or equal) negative pulse	

Pulse width	20ns – 10ns	
Video Trigger		
Trigger sensitivity (video trigger, Typical)	Internal	2 div peak-to-peak
	EXT	400mV
	EXT/5	2V
Signal format and line/field frequency (video trigger type)	Supports standard NTSC and PAL. Line range: 1-525 (NTSC) and 1-625 (PAL)	
Alternate Trigger		
CH1 Trigger	Edge, pulse, video	
CH2 Trigger	Edge, pulse, video	

Measurement		
Cursor	Manual mode	Voltage difference (ΔV) between cursors, time difference (ΔT) between cursors, ΔT countdown (Hz) ($1/\Delta T$)
	Tracking mode	Voltage or time value of waveform dots
	Auto measurement mode	Allows cursor display during auto measurement
Auto measurement	Measuring peak-to-peak, amplitude, maximum, minimum, top, base, middle, average, root mean square value, overshoot, preshoot, frequency, cycle, rise time, fall time, positive pulse, negative pulse, positive duty ratio, negative duty ratio, delay 1->2 \uparrow , and delay 1->2 \downarrow .	
Math functions	$+$, $-$, \times , \div	
Saving waveforms	10 groups and 10 setups	
FFT	Window	Hanning, Hamming, Blackman, Rectangle
	Sampling points	1024 points
Lissajous figure	Phase difference	± 3 degrees

DSO Series User Manual

Display	
Display Type	145 mm(5.7 in) diagonal liquid crystal
Display Resolution	320 horizontal by RGB by 240 vertical pixels
Display	Color
Contrast (typical)	Adjustable
Backlight Intensity (Typical)	300 nit
Display Languages	Simplified Chinese, Traditional Chinese, English

Interface Functions	
72-8395	1 x USB (D), 1 x RS-232C
72-8390, 72-8385, 72-8380, 72-8250, 72-8245, 72-8240, 72-8230, 72-8225,	1 x USB (D), 1 x USB (H), 1 x RS-232C

Power Source	
Source Voltage	100 - 240 VACRMS, 45-440Hz, CAT II
Power Consumption	Less than 50 VA
Fuse	F1.6AL 250V。 72-8395 ,72-8250,72-8245,72-8240,72-8230,72-8225 has one fuse, located besides the power button. 72-8390, 72-8385, 72-8380 have one fuse, located above the power socket.

Environmental	
Temperature	Operating: 0°C ~ +40°C
	Non-operating: -20 °C ~ +60°C
Cooling Method	Forced fan cooling
Humidity	<+35°C (≤ 90% RH)
	+35°C ~ +40°C (≤ 60% RH)
Altitude	Operating: Under 2,000m
	Non-operating: under 15,000m

Mechanical Specifications			
		72-8395	72-8390
Dimension	Width	320 mm	320mm
	Height	150 mm	150mm
	Depth	130mm	292mm
Weight	Instrument only	2.6 kg	4.5 kg
	Including package	4.1kg	6.0kg
IP Protection			
ip2 X			
Adjustment Interval			
Recommended interval of calibration is one year			

Appendix B: Accessories for Tenma DSO Series Oscilloscopes Standard Accessories

- Two 1.2m, 1:1 (10:1) passive voltage probes (see passive voltage probe operating manual) , comply with EN61010-031: 2002 standard.
Rating is 150V CAT II when the switch is in the 1X position;Rating is 300V CAT II when the switch is in the 10X position.
- One international power cord.
- One User Manual
- Communications software (USB/RS-232C)
- USB Lead: UT-D04

Appendix C: Maintenance and Cleaning General Care

Do not store or leave the oscilloscope where the LCD display will be exposed to direct sunlight for long

periods of time. Caution: To avoid damage to the oscilloscope or probes, do not expose them to sprays, liquids, or solvents.

Cleaning

Inspect the oscilloscope and probes as often as operating conditions require. To clean the exterior surface, perform the following steps:

1. Remove loose dust on the outside of the oscilloscope and probes with a soft cloth. Take care to avoid scratching the clear glass display filter when cleaning the LCD.
2. Use a dampened but not dripping soft cloth to clean the oscilloscope. Remember to disconnect power. Use a mild cleaner or water. To avoid damaging the oscilloscope or probes, do not use abrasive chemical cleaner.

Warning: To avoid short circuit or personal injury due to the presence of moisture, please ensure the product is completely dry before reconnecting power for operation.

Index

Numerical

50% button..... 22

Alphabet

DSO..... 57

EXT..... 44

EXT/5..... 44

FFT resolution..... 32

FFT frequency analysis 31

RS-232C..... 94

USB..... 35

X-Y mode..... 37

Y-T mode..... 37

Chinese

General check..... 13

General care..... 96

Rise time..... 65

Fall time..... 65

System prompts..... 86

Refresh rate 56

Single trigger 50

Cycle 66

Vertical system 24

Grid 49

Acquisition 51

Cursor measurement..... 81

Display system 55

Compulsory 22

Horizontal system..... 19

Math..... 30

Measurement..... 70

Reference waveform..... 32

RUN/STOP..... 71

Saving 70

Trigger system 45

Functions..... 58

Vertical system 23

Return to zero 18

Select..... 70

Coarse tune..... 24

Nyquist frequency..... 34

Realtime sampling..... 51

DSO Series User Manual

Top value.....	65	Using the RUN button	71
Base value.....	65	Horizontal system.....	35
Technical indicators.....	88	Factory setup.....	60
Waveform inversion.....	29	Functional check.....	13
Waveform recording.....	61	External trigger	49
Pulse trigger.....	40	Average.....	64
Video trigger.....	40	Average acquisition.....	51
Cleaning.....	96	Positive pulse width.....	43
Top value.....	65	Power warning	96
Save.....	58	Edge trigger.....	21
Warranty	86	Alternate trigger.....	46
Signal source.....	30	Cursor measurement.....	81
Bandwidth limit	24	Tracking.....	71
Troubleshooting.....	86	Video synchronization.....	45
Window extension.....	38	Field synchronization.....	45
Display system	55	Save and recall	56
Display type.....	94	RUN button.....	77
Standard accessories	96	Mechanical specifications.....	95
Measuring simple signals.....	74	Auto setup.....	72
Sec/div	19	Auto measurement.....	64
Pulse width trigger.....	40	Auto trigger.....	49
Language selection.....	59	Self calibration	59
Off	19	Line synchronization.....	45

Negative pulse width.....	47	Trigger setup.....	21
Root mean square value.....	64	Trigger system.....	21
Peak measurement.....	51	Holdoff	36
Peak-to-peak value.....	64	Trigger coupling.....	22
Acquiring single signals	77	Input channel.....	49
Recall.....	56	Interface design.....	60
Range adjustment.....	28	Overshoot.....	66
Delayed measurement.....	64	Preshoot.....	66
Channel setup.....	26	Mean.....	67
Channel coupling.....	25	Amplitude.....	30
Pretrigger.....	50	Positive duty ratio.....	65
Reducing signal random noise.....	78	Negative duty ratio.....	65
Probe compensation.....	16		
Probe rate.....	27		
Sampling system.....	51		
Coarse tune/fine tune.....	29		
Alternative system functions.....	58		
Maximum value	55		
Minimum value	55		
Equivalent sampling.....	51		
Math.....	30		
Trigger level.....	21		

**** END ****

The contents of this user manual may be revised without prior notice.

©Copyright 2011 Tenma Test Equipment.
All rights reserved.

Manufacturer:
Tenma Test Equipment
405 S. Pioneer Blvd.
Springboro Ohio 45066
USA
<http://www.tenma.com>