

Features:

- High efficiency.
- High transparent low-iron, tempered glass.
- Unique techniques give the panel following features: aesthetic appearance, with stands high wind-pressure and snow load, and easy installation.
- Outstanding low-light performance.
- Nominal DC for standard output.
- Unique technology ensure that problems of water freezing and warping do not occur.
- Design to meet unique demand of customer.

Quality Assurance:

Realsun photovoltaic modules have passed the following tests.

Thermal cycling test.

Thermal shock test.

Thermal/freezing and high humidity cycling test.

Electrical isolation test.

Hail impact test.

Mechanical, wind and twist loading test.

Salt mist test.

Light and water-exposure test.

Field exposure test.

Electrical Characteristics:

I-V Curves

Current-voltage characteristics of photovoltaic Module SP30 at various cell temperatures

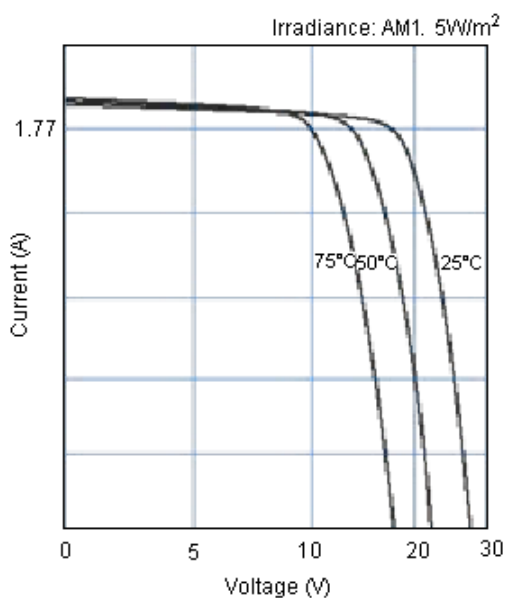

Current-voltage characteristics of photovoltaic Module SP30 at various irradiance levels

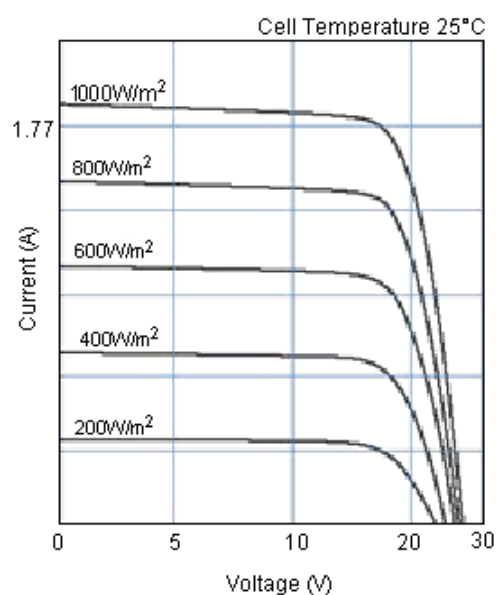

Physical Specifications

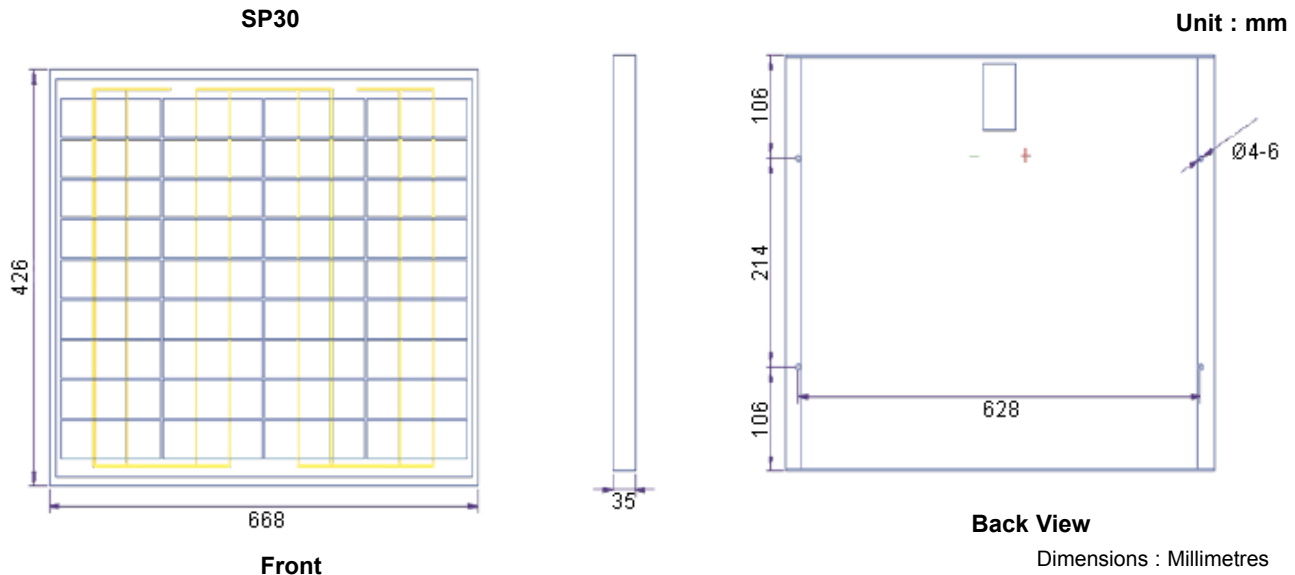

Specifications:

MONO or poly	: Poly.
Maximum power	: 30Wp.
Maximum power voltage	: 17.00V.
Maximum power current	: 1.77A.
Open circuit voltage	: 21.50V.
Short circuit current	: 1.93A.
Size of module	: 426 x 668 x 35mm.
Weight	: 6.36Kg.
Package	: 1pc/box.
Maximum system voltage	: 720V dc.
Temperature coefficients of Isc	: 0.06%/K.
Temperature coefficients of Voc	: -0.36%/K.
Temperature coefficients of Pm	: -0.45%/K.
Temperature range	: -40°C to +85°C.
Surface maximum load capacity	: 60ms (200kg/sq.m).
Allowable hail load	: Steel ball fall down from 1m height.
Length of cables	: Terminals.
Output tolerance	: ±3%.
Frame (material, corners, etc.)	: Aluminium (epx 0.8w).
Warranty	: Free from defects in materials and workmanship for 5 years/10 years on 90% of the minimum power output/25 years on 80% of the minimum power output.

Part Number Table

Description	Part Number
Solar Panel, 30W, 17.5V, 668 x 426 x 35mm	MC-SP30-GCS

Disclaimer This data sheet and its contents (the "Information") belong to the Premier Farnell Group (the "Group") or are licensed to it. No licence is granted for the use of it other than for information purposes in connection with the products to which it relates. No licence of any intellectual property rights is granted. The Information is subject to change without notice and replaces all data sheets previously supplied. The Information supplied is believed to be accurate but the Group assumes no responsibility for its accuracy or completeness, any error in or omission from it or for any use made of it. Users of this data sheet should check for themselves the Information and the suitability of the products for their purpose and not make any assumptions based on information included or omitted. Liability for loss or damage resulting from any reliance on the Information or use of it (including liability resulting from negligence or where the Group was aware of the possibility of such loss or damage arising) is excluded. This will not operate to limit or restrict the Group's liability for death or personal injury resulting from its negligence. SPC Multicomp is the registered trademark of the Group. © Premier Farnell plc 2010.