

Type: **DILER-22(380V50HZ,440V60HZ)**

Article No.: **051778**



Ordering information

Actuating voltage			380V 50Hz, 440V 60Hz
Connection technique			Screw terminals
Contacts M = Make			2 M
Contacts B = Break			2 B
Conventional thermal current	I_{th}	A	10
Distinctive number and version of combination			22 E

Contact sequence

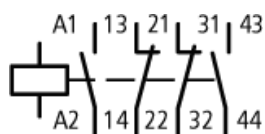

General

Standards			IEC/EN 60947, VDE 0660, UL, CSA
Climatic proofing			Damp heat, constant, to IEC 60068-2-78; Damp heat, cyclical, to IEC 60068-2-30
Protection against direct contact when actuated from front (IEC 536)			Finger- and back-of-hand proof
Terminal capacities			
Pozidriv screwdriver		Size	2
max. tightening torque		Nm	1,2

Contacts

Overvoltage category/pollution degree			III/3
Rated insulation voltage	U_i	V AC	690

Magnet systems

Power consumption			
Single-voltage coil 50 Hz and dual-voltage coil 50 Hz, 60 Hz	Pick-up	VA	25
Dimensions			
			DILER-...
			DILER-... + ...DILE

Dimensions

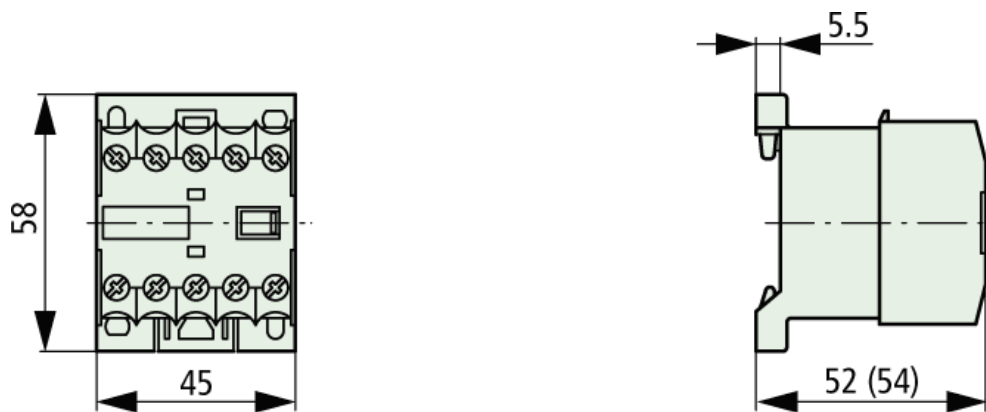

Dimensions

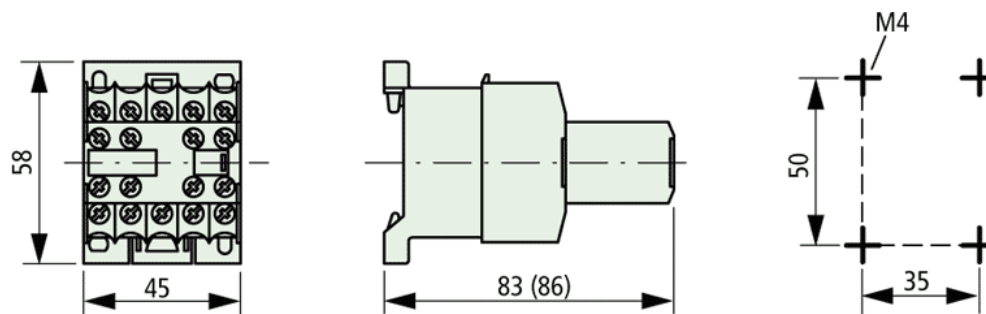

Moeller GmbH, Hein-Moeller-Str. 7-11, D-53115 Bonn
 E-Mail: catalog@moeller.net, Internet: www.moeller.net, <http://catalog.moeller.net>
 Copyright 2005 by Moeller GmbH. Subject to modifications. HPL-C2005GB-INT V3.0