

Type: **DILA-40(24V50HZ)**
 Article No.: **276316**



Ordering information

Rated operational current AC-15 220 V 230 V 240 V	I_e	A	6
Rated operational current AC-15 380 V 400 V 415 V	I_e	A	4
Conventional current, open at 60 °C	I_{th}	A	10
Can be combined with auxiliary contact module			DILA-XHI(V)...

Contact sequence

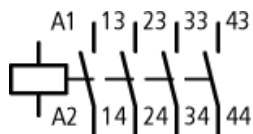

Notes concerning the product group

With screw terminals:

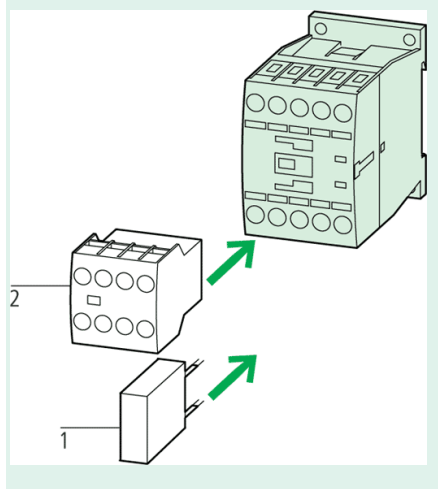

<i>Accessories</i>	<i>Page</i>
1 Suppressor	→ 281208
2 Auxiliary contact module	→ 276420
Further actuating voltages	→ 276315

With springloaded terminals:

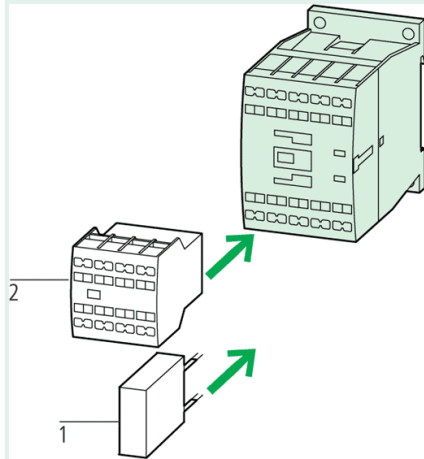

<i>Accessories</i>	<i>Page</i>
1 Suppressor	→ 281208
2 Auxiliary contact module	→ 276420
Further actuating voltages	→ 276315

Contact numbers to EN 50011

Coil terminal markings to EN 50005

DC operated contactor relays have a built-in suppressor circuit.

Contacts

Rated operational current			
AC-15			
220/240 V	I_e	A	6
380/415 V	I_e	A	4

Moeller GmbH, Hein-Moeller-Str. 7-11, D-53115 Bonn
 E-Mail: catalog@moeller.net, Internet: www.moeller.net, <http://catalog.moeller.net>
 Copyright 2005 by Moeller GmbH. Subject to modifications. HPL-C2005GB-INT V3.0