

Type: **ZB65-24**
 Article No.: **278457**

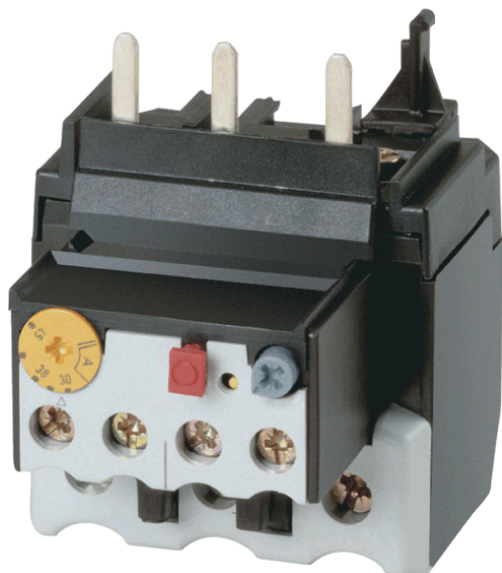

Ordering information

Overload release, min. – max.	I_r	A	16 – 24
Auxiliary contacts M = Make			1 M
Auxiliary contacts B = Break			1 B
For use with			DILM40, DILM50, DILM65, DIULM40, DIULM50, DIULM65,
Short-circuit protection Type “1” coordination	gG/gL	A	63
Short-circuit protection Type “2” coordination	gG/gL	A	50

Contact sequence

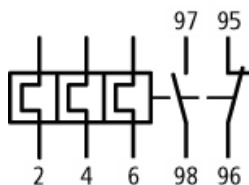

Note concerning the product

Overload release: tripping class 10 A

Short-circuit protection: Observe the maximum permissible fuse of the contactor with direct device mounting.

Suitable for protection of EEx e-motors. EC prototype test certification on request.

Notes concerning the product group

Fitted directly to the contactor Separate mounting

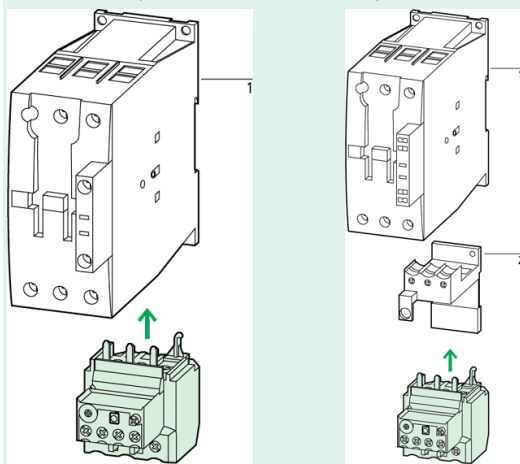

1 Contactor
2 Bases

→ 051608
→ 278474

General

Standards			IEC/EN 60947, VDE 0660, UL, CSA
Climatic proofing			Damp heat, constant, to IEC 60068-2-78; Damp heat, cyclic, to IEC 60068-2-30
Ambient temperature			
Open		°C	-25/50
Enclosed		°C	-25/40
Temperature compensation			Continuous
Weight			
Mechanical shock resistance half-sinusoidal shock 10 ms to IEC 60068-2-27		g	10
Protection type			IP00
Protection against direct contact when actuated from front (IEC 536)			Finger- and back-of-hand proof

Main conducting paths

Rated impulse withstand voltage	U_{imp}	V AC	6000
Overvoltage category/pollution degree			III/3
Rated insulation voltage			
AC	U_i	V AC	690
Rated operational voltage	U_e	V AC	690
Safe isolation to VDE 0106 Part 101 and Part 101/A1			
Between auxiliary contacts and main contacts		V AC	440
Between main circuits		V AC	440
Overload release setting range		A	6 – 75
Temperature compensation residual error > 20°C		%/K	f 0.25
Current heat loss (3 conductors)			
Lower value of the setting range		W	3
Maximum setting		W	7,5
Terminal capacities			
Solid		mm ²	2 × (1 – 16)

Flexible with ferrule		mm ²	1 × 25 2 × (1 – 10)
Stranded		mm ²	1 × 35 2 × 10
Solid or stranded		AWG	14 – 2
Terminal screw			M6
Tightening torque		Nm	3.5
Tools			
Pozidriv screwdriver		Size	2
Standard screwdriver		mm	1 × 6

Auxiliary and control circuits

Rated impulse withstand voltage	U_{imp}	V	6000
Overvoltage category/pollution degree			III/3
Terminal capacities			
Solid		mm ²	2 × (0.75 – 4)
Flexible with ferrule		mm ²	2 × (0.75 – 2.5)
Solid or stranded		AWG	2 × (18 – 12)
Terminal screw			M3.5
Tightening torque		Nm	0.8 – 1.2
Tools			
Pozidriv screwdriver		Size	2
Standard screwdriver		mm	1 × 6
Rated insulation voltage	U_i	V AC	500
Rated operational voltage	U_e	V AC	500
Safe isolation to VDE 0106 Part 101 and Part 101/A1 between the auxiliary contacts		V AC	240
Conventional thermal current	I_{th}	A	6
Rated operational current			
AC–15			
Make contact			
120 V	I_e	A	1,5
240 V	I_e	A	1,5
415 V	I_e	A	0,5
500 V	I_e	A	0,5
Break contact			
120 V	I_e	A	1,5
240 V	I_e	A	1,5
415 V	I_e	A	0,9
500 V	I_e	A	0,8
DC–13 L/R f 15 ms			
24 V	I_e	A	0,9
60 V	I_e	A	0,75
110 V	I_e	A	0,4
220 V	I_e	A	0,2
Short–circuit rating without welding			
max. fuse		A gG/gL	6

Notes

Ambient temperature: operating range to IEC/EN 60947, PTB: -5°C to $+50^{\circ}\text{C}$
Rated operational current: Making and breaking conditions to DC-13, L/R constant as stated
See overlay: "Fuses" for short-circuit rating time/current characteristic (please enquire)
Main contacts terminal capacity solid and stranded conductors with ferrules: When using 2 conductors use identical cross-section

Dimensions

With base ZB65-XEZ

Dimensions

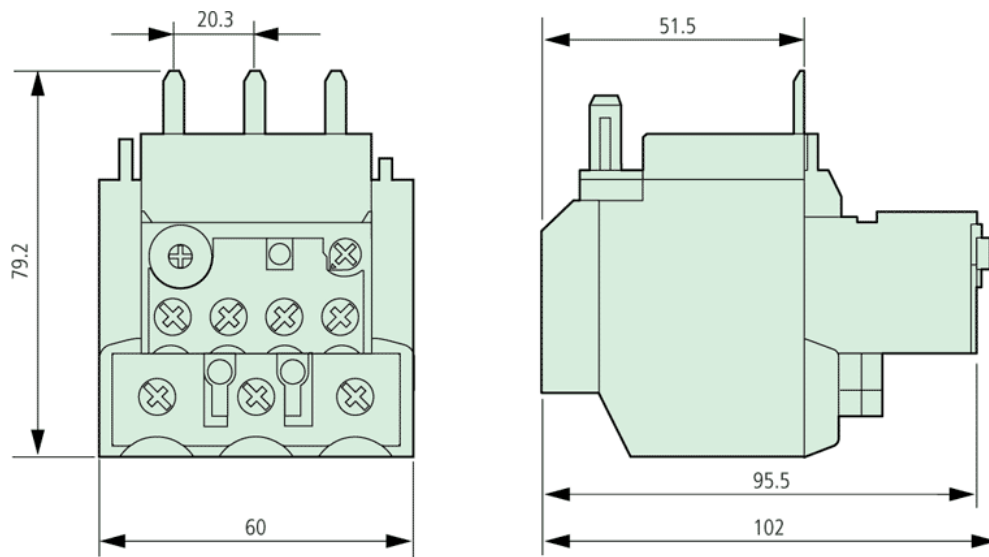

Dimensions

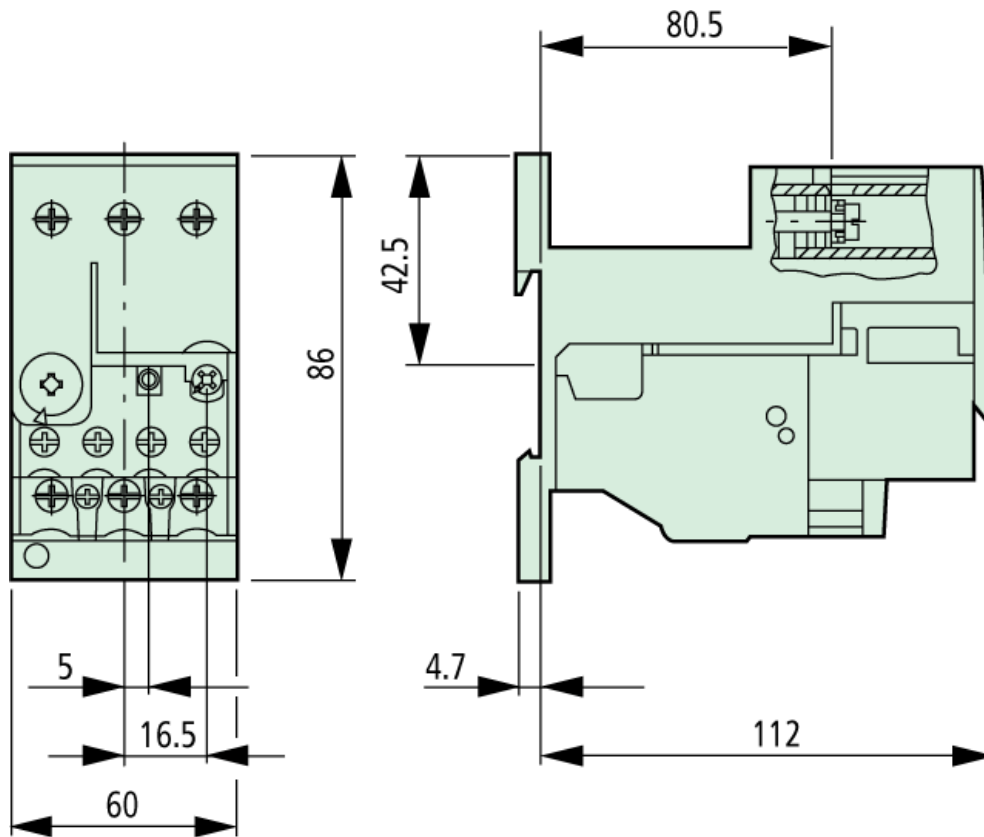

Moeller GmbH, Hein-Moeller-Str. 7-11, D-53115 Bonn
E-Mail: catalog@moeller.net, Internet: www.moeller.net, <http://catalog.moeller.net>
Copyright 2005 by Moeller GmbH. Subject to modifications. HPL-C2005GB-INT V3.0