

Agilent HLMP-ALxx, HLMP-BLxx, HLMP-ADxx, HLMP-BDxx, HLMP-BB11, HLMP-BM11 T-1³/₄ (5 mm) Oval Precision Optical Performance AlInGaP and InGaN Lamps Data Sheet



Description

These Precision Optical Performance Oval LEDs are specifically designed for full color/video and passenger information signs. The oval shaped radiation pattern (35° x 70°) and high luminous intensity ensure that these devices are excellent for wide field of view outdoor application where a wide viewing angle and readability in sunlight are essential. These lamps have very smooth, matched radiation patterns ensuring consistent color mixing in full color applications, message uniformity across the viewing angle of the sign.

High efficiency LED material is used in these lamps: Aluminum Indium Gallium Phosphide (AlInGaP) for amber and red, and Indium Gallium Nitride (InGaN) for blue and green. Each lamp is made with an advance optical grade epoxy offering superior high temperature and high moisture resistance in outdoor applications. The package epoxy contains both UV-A and UV-B inhibitors to reduce the effects of long term exposure to direct sunlight.

Designers can select parallel or perpendicular orientation. Both lamps are available in tinted version.

Features

- Well defined spatial radiation pattern
- Viewing angles:
Major axis 70°
Minor axis 35°
- High luminous output
- AllInGaP II (brightest) intensity level
- Colors:
472 nm blue
526 nm green
626 nm red
630 nm red
590 nm amber
592 nm amber
- Superior resistance to moisture
- UV resistant epoxy

Benefits

- Viewing angle designed for wide field of view application
- Red, green, and blue radiation patterns matched for full color sign
- Superior performance in outdoor environments

Applications

- Full color/video signs

CAUTION: The blue and green LEDs are Class 1 ESD sensitive. Please observe appropriate precautions during handling and processing. Refer to Agilent Application Note AN-1142 for additional details.



Table 1. Device Selection Guide for AlInGaP II

Part Number	Color and Dominant Wavelength λ_d (nm) Typ.	Luminous Intensity, I_v (mcd) Min.	Luminous Intensity, I_v (mcd) Max.	Forward Voltage, V_f (V) Max.	Leads with Stand-offs	Leadframe Orientation	Package Drawing
HLMP-AD06-P00xx	Red 630	765		2.4	No	Parallel	A
HLMP-AD06-P0Txx	Red 630	765		2.4	No	Parallel	A
HLMP-AD16-P00xx	Red 630	765		2.4	Yes	Parallel	B
HLMP-AD16-P0Txx	Red 630	765		2.4	Yes	Parallel	B
HLMP-AD16-RS0xx	Red 630	1300	2900	2.6	Yes	Parallel	B
HLMP-AD16-RSTxx	Red 630	1300	2900	2.6	Yes	Parallel	B
HLMP-AD16-RU0xx	Red 630	1300	4800	2.4	Yes	Parallel	B
HLMP-AD16-RUTxx	Red 630	1300	4800	2.6	Yes	Parallel	B
HLMP-AD16-ST0xx	Red 630	1650	3700	2.4	Yes	Parallel	B
HLMP-AD16-STTxx	Red 630	1650	3700	2.6	Yes	Parallel	B
HLMP-AL06-L00xx	Amber 592	345		2.4	No	Parallel	A
HLMP-AL06-L0Rxx	Amber 592	345		2.6	No	Parallel	A
HLMP-AL06-N00xx	Amber 592	590		2.4	No	Parallel	A
HLMP-AL06-N0Rxx	Amber 592	590		2.6	No	Parallel	A
HLMP-AL16-N00xx	Amber 592	590		2.4	Yes	Parallel	B
HLMP-AL16-N0Rxx	Amber 592	590		2.6	Yes	Parallel	B
HLMP-AL16-PSRxx	Amber 592	765	2900	2.6	Yes	Parallel	B
HLMP-AL16-QR0xx	Amber 592	1000	2200	2.4	Yes	Parallel	B
HLMP-AL16-QRRxx	Amber 592	1000	2200	2.6	Yes	Parallel	B
HLMP-BD06-P00xx	Red 630	765		2.4	No	Perpendicular	C
HLMP-BD06-P0Txx	Red 630	765		2.6	No	Perpendicular	C
HLMP-BD06-RS0xx	Red 630	1300	2900	2.4	No	Perpendicular	C
HLMP-BD06-RSTxx	Red 630	1300	2900	2.6	No	Perpendicular	C
HLMP-BD16-P00xx	Red 630	765		2.4	Yes	Perpendicular	D
HLMP-BD16-P0Txx	Red 630	765		2.6	Yes	Perpendicular	D
HLMP-BD16-RU0xx	Red 630	1300	4800	2.4	Yes	Perpendicular	D
HLMP-BD16-RUTxx	Red 630	1300	4800	2.6	Yes	Perpendicular	D
HLMP-BD16-ST0xx	Red 630	1650	3700	2.4	Yes	Perpendicular	D
HLMP-BD16-STTxx	Red 630	1650	3700	2.6	Yes	Perpendicular	D
HLMP-BL06-N00xx	Amber 592	590		2.4	No	Perpendicular	C
HLMP-BL06-N0Rxx	Amber 592	590		2.6	No	Perpendicular	C
HLMP-BL06-QRKxx	Amber 592	1000	2200	2.4	No	Perpendicular	C
HLMP-BL06-QRSxx	Amber 592	1000	2200	2.6	No	Perpendicular	C
HLMP-BL16-N00xx	Amber 592	590		2.4	Yes	Perpendicular	D
HLMP-BL16-N0Rxx	Amber 592	590		2.6	Yes	Perpendicular	D
HLMP-BL16-PS0xx	Amber 592	765	2900	2.4	Yes	Perpendicular	D
HLMP-BL16-PSRxx	Amber 592	765	2900	2.6	Yes	Perpendicular	D

**Table 2. LED Indicators
Device Selection Guide for AlInGaP**

Part Number	Color and Dominant Wavelength λ_d (nm) Typ.	Luminous Intensity, I_v (mcd) Min.	Luminous Intensity, I_v (mcd) Max.	Leads with Stand-offs	Leadframe Orientation	Package Drawing
HLMP-AG01-K00xx	Red 626	270		No	Parallel	A
HLMP-AG11-KN0xx	Red 626	270	1010	Yes	Parallel	B
HLMP-AL01-K00xx	Amber 590	270		No	Parallel	A
HLMP-AL01-LP0xx	Amber 590	345	1330	No	Parallel	A
HLMP-AL01-NR0xx	Amber 590	590	2200	No	Parallel	A
HLMP-AL11-KN0xx	Amber 590	270	1010	Yes	Parallel	B
HLMP-AL11-NR0xx	Amber 590	590	2200	Yes	Parallel	B
HLMP-BG01-MN0xx	Red 626	450	1010	No	Perpendicular	C
HLMP-BG11-KN0xx	Red 626	270	1010	Yes	Perpendicular	D
HLMP-BL01-NR0xx	Amber 590	590	2200	No	Perpendicular	C
HLMP-BL11-KN0xx	Amber 590	270	1010	Yes	Perpendicular	D
HLMP-BL11-NR0xx	Amber 590	590	2200	Yes	Perpendicular	D

Table 3. Device Selection Guide for InGaN

Part Number	Color and Dominant Wavelength λ_d (nm) Typ.	Luminous Intensity, I_v (mcd) Min.	Leads with Stand-offs	Leadframe Orientation	Package Drawing
HLMP-AB01-J00xx	Blue 472	205	No	Parallel	A
HLMP-BB11-J00xx	Blue 472	205	Yes	Perpendicular	D
HLMP-BB11-K00xx	Blue 472	270	Yes	Perpendicular	D
HLMP-BM11-L00xx	Green 526	345	Yes	Perpendicular	D
HLMP-BM11-Q00xx	Green 526	1000	Yes	Perpendicular	D

Part Numbering System

HLMP-X X X X-X X X X X

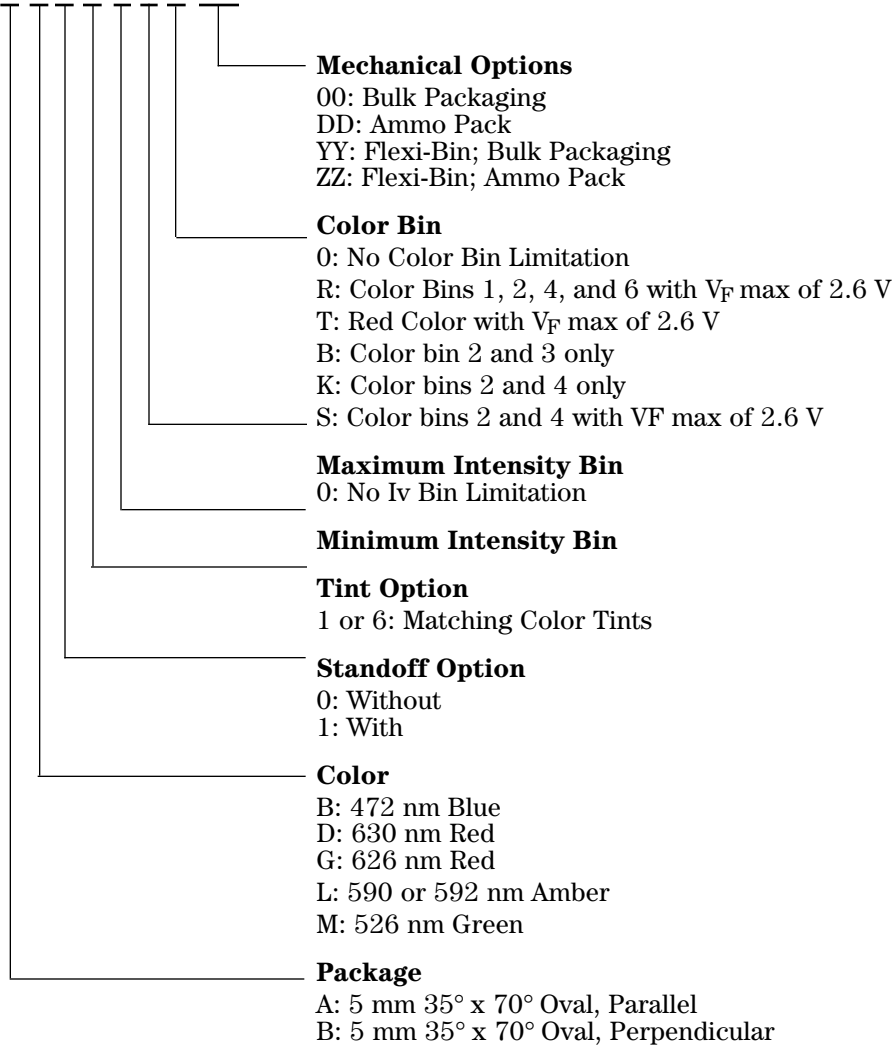

Package Dimensions

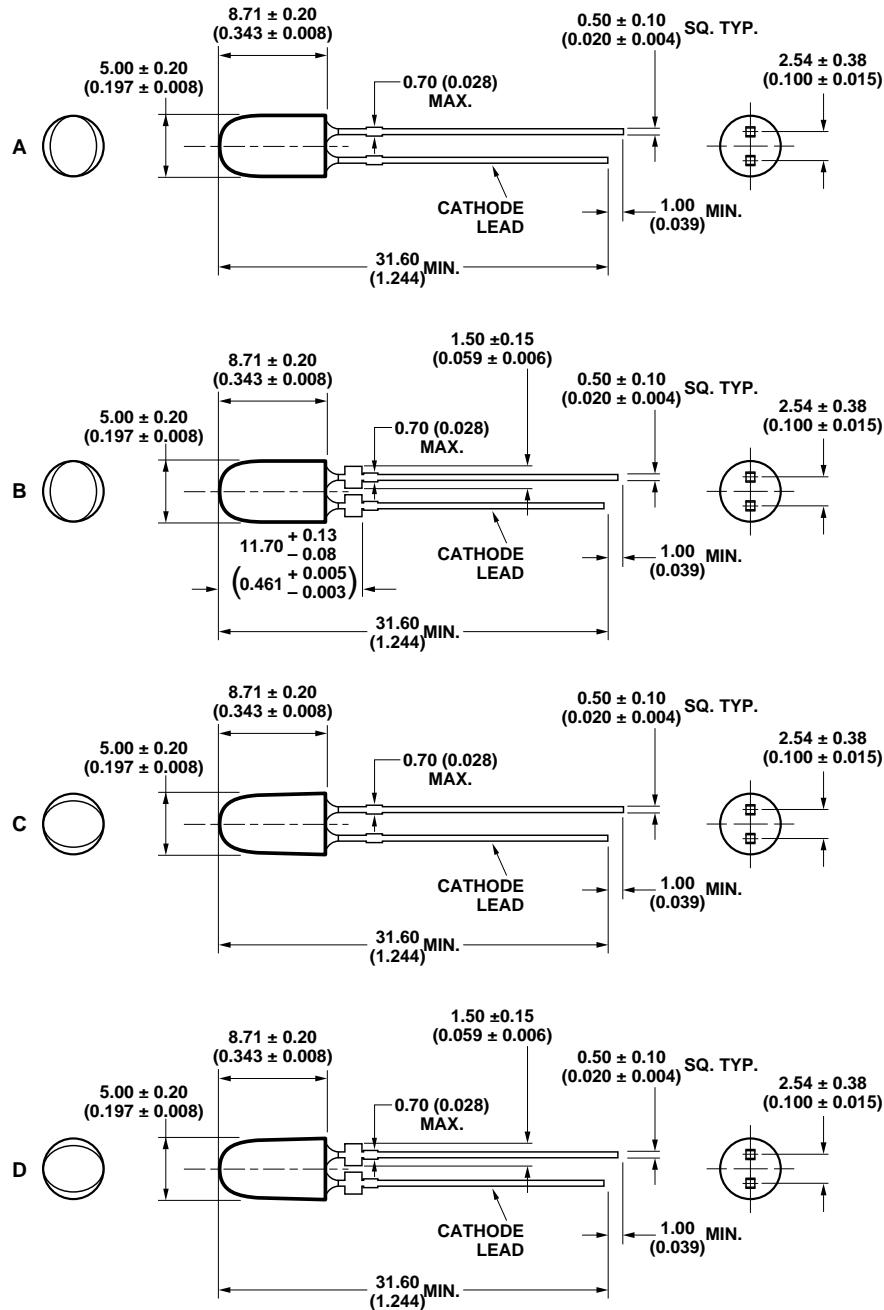

NOTES:

1. ALL DIMENSIONS ARE IN MILLIMETERS (INCHES).
2. LEADS ARE MILD STEEL, SOLDER DIPPED.
3. TAPERS SHOWN AT TOP OF LEADS (BOTTOM OF LAMP PACKAGE) INDICATE AN EPOXY MENISCUS THAT MAY EXTEND ABOUT 1 mm (0.040 IN.) DOWN THE LEADS.
4. RECOMMENDED PC BOARD HOLE DIAMETERS:
 - LAMP PACKAGES A AND C WITHOUT STAND-OFFS: FLUSH MOUNTING AT BASE OF LAMP PACKAGE = 1.143/1.067 mm (0.044/0.042 IN.).
 - LAMP PACKAGES B AND D WITH STAND-OFFS: MOUNTING AT LEAD STAND-OFFS.

Absolute Maximum Ratings at T_A = 25°C

Parameter	Blue and Green	Red and Amber
DC Forward Current ^[1]	30 mA	50 mA
Peak Pulsed Forward Current	100 mA	100 mA
Average Forward Current	30 mA	30 mA
Reverse Voltage (I _R = 100 μA)		5 V
Reverse Voltage (I _R = 10 μA)	5 V	
Power Dissipation	120 mW	120 mW
LED Junction Temperature	130°C	130°C
Operating Temperature Range	-40°C to +80°C	-40°C to +100°C
Storage Temperature Range	-40°C to +100°C	-40°C to +120°C
Soldering Temperature	260°C for 5 seconds	260°C for 5 seconds

Electrical/Optical Characteristics at T_A = 25°C

Parameter	Symbol	Min.	Typ.	Max.	Units	Test Conditions
Typical Viewing Angle						
Major	2θ _{1/2}		70		deg	
Minor			35			
Forward Voltage	V _F					I _F = 20 mA
Amber (λ _d = 592 nm)			2.15	2.60	V	
Red (λ _d = 630 nm)			2.00	2.60		
Blue (λ _d = 472 nm)			3.5	4.0		
Green (λ _d = 526 nm)			3.5	4.0		
Reverse Voltage						
Amber, Red	V _R	5	20		V	I _R = 100 μA
Blue, Green		5	–			I _R = 10 μA
Peak Wavelength						
Amber (λ _d = 592 nm)	λ _{peak}		594		nm	Peak of Wavelength of Spectral Distribution at I _F = 20 mA
Red (λ _d = 630 nm)			639			
Blue (λ _d = 472 nm)			470			
Green (λ _d = 526 nm)			524			
Spectral Halfwidth						
Amber (λ _d = 592 nm)	Δλ _{1/2}		17		nm	Wavelength Width at Spectral Distribution 1/2 Power Point at I _F = 20 mA
Red (λ _d = 630 nm)			17			
Blue (λ _d = 472 nm)			35			
Green (λ _d = 526 nm)			47			
Capacitance						V _F = 0, F = 1 MHz
Amber, Red	C		40		pF	
Blue, Green			43			
Luminous Efficacy						
Amber (λ _d = 592 nm)	η _v		500		lm/W	Emitted Luminous Power/Emitted Radiant Power at I _F = 20 mA
Red (λ _d = 630 nm)			155			
Blue (λ _d = 472 nm)			75			
Green (λ _d = 526 nm)			520			
Thermal Resistance	R _{ΘJ-PIN}		240		°C/W	LED Junction-to-Cathode Lead

Notes:

- 2θ_{1/2} is the off-axis angle where the luminous intensity is 1/2 the on-axis intensity.
- The radiant intensity, I_e in watts per steradian, may be found from the equation I_e = I_v/η_v, where I_v is the luminous intensity in candelas and η_v is the luminous efficacy in lumens/watt.
- The luminous intensity is measured on the mechanical axis of the lamp package.
- The optical axis is closely aligned with the package mechanical axis.
- The dominant wavelength λ_d is derived from the CIE Chromaticity Diagram and represents the color of the lamp.

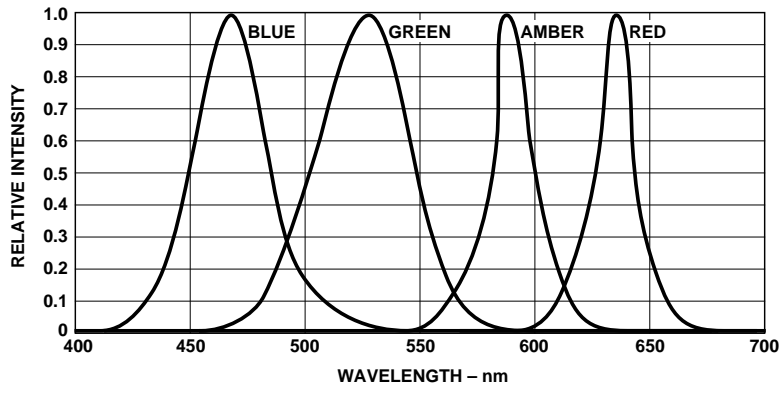

Figure 1. Relative intensity vs. wavelength.

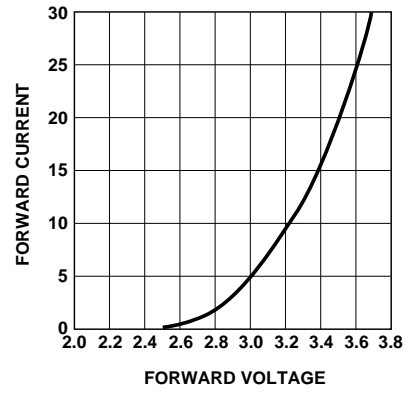

Figure 2. Blue, green forward current vs. forward voltage.

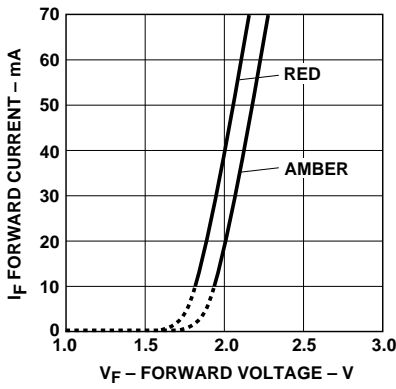

Figure 3. Amber, red forward current vs. forward voltage.

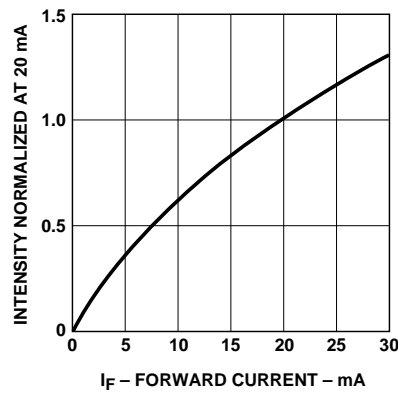

Figure 4. Blue, green relative luminous intensity vs. forward current.

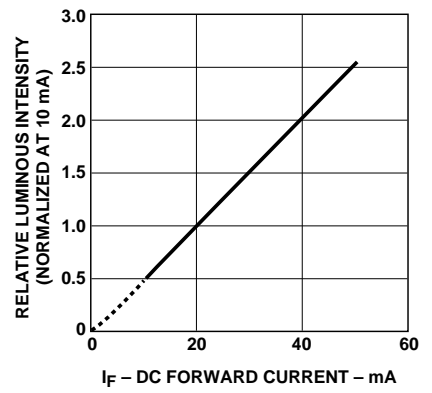

Figure 5. Amber, red relative luminous intensity vs. forward current.

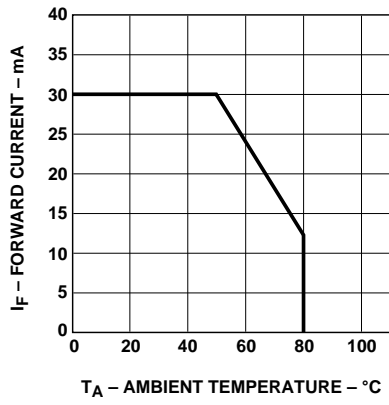

Figure 6. Blue, green maximum forward current vs. ambient temperature.

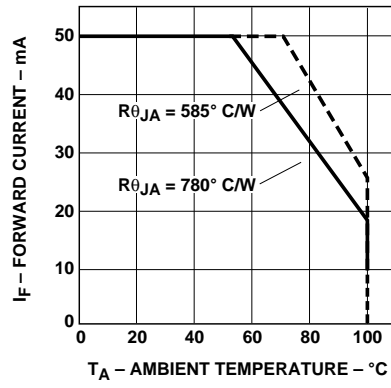

Figure 7. Amber, red maximum forward current vs. ambient temperature.

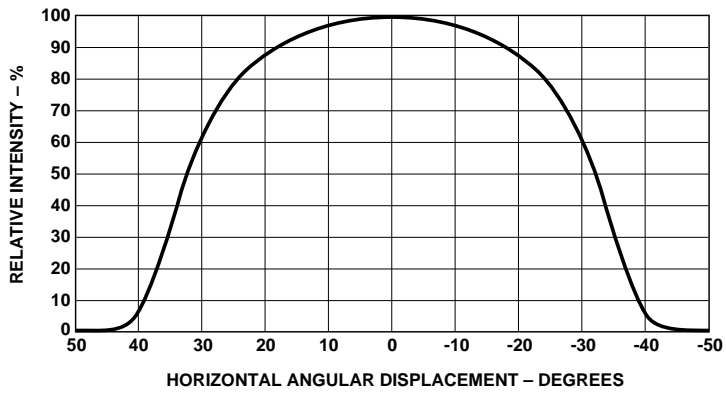
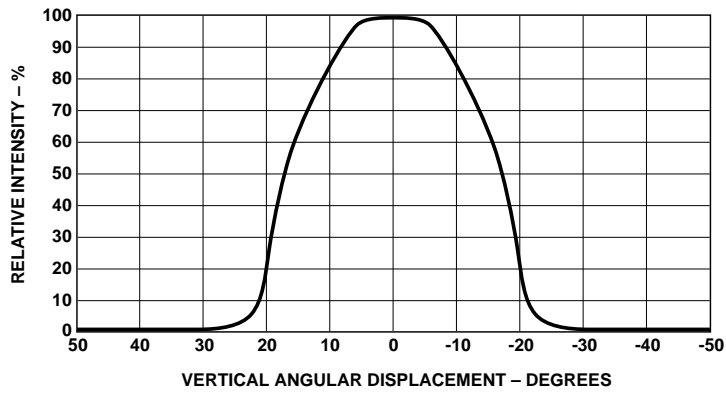

Figure 8. Spatial radiation pattern – 35 x 70 degree lamps.

**Intensity Bin Limits
(mcd at 20 mA)**

Bin Name	Min.	Max.
G	140	180
H	180	240
J	240	310
K	310	400
L	400	520
M	520	680
N	680	880
P	880	1150
Q	1150	1500
R	1500	1900
S	1900	2500

Tolerance for each bin limit is $\pm 15\%$.

**Amber Color Bin Limits
(nm at 20 mA)**

Bin Name	Min.	Max.
1	584.5	587.0
2	587.0	589.5
4	589.5	592.0
6	592.0	594.5

Tolerance for each bin limit is ± 0.5 nm.

**Blue Color Bin Limits
(nm at 20 mA)**

Bin Name	Min.	Max.
1	460.0	464.0
2	464.0	468.0
3	468.0	472.0
4	472.0	476.0
5	476.0	480.0

Tolerance for each bin limit is ± 2 nm.

**Green Color Bin Limits
(nm at 20 mA)**

Bin Name	Min.	Max.
1	520.0	524.0
2	524.0	528.0
3	528.0	532.0
4	532.0	536.0
5	536.0	540.0

Tolerance for each bin limit is ± 0.5 nm.

Note:

1. All bin categories are established for classification of products. Products may not be available in all bin categories. Please contact your Agilent representative for further information.

www.agilent.com/semiconductors

For product information and a complete list of distributors, please go to our web site.

For technical assistance call:

Americas/Canada: +1 (800) 235-0312 or
(408) 654-8675

Europe: +49 (0) 6441 92460

China: 10800 650 0017

Hong Kong: (+65) 6271 2451

India, Australia, New Zealand: (+65) 6271 2394

Japan: (+81 3) 3335-8152(Domestic/International), or 0120-61-1280(Domestic Only)

Korea: (+65) 6271 2194

Malaysia, Singapore: (+65) 6271 2054

Taiwan: (+65) 6271 2654

Data subject to change.

Copyright © 2002 Agilent Technologies, Inc.

Obsoletes 5988-7307EN

October 27, 2002

5988-8247EN



Agilent Technologies