

### ■ Dimensions

**Note:** All units are in millimeters unless otherwise indicated.

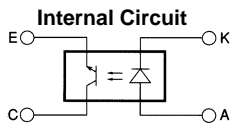
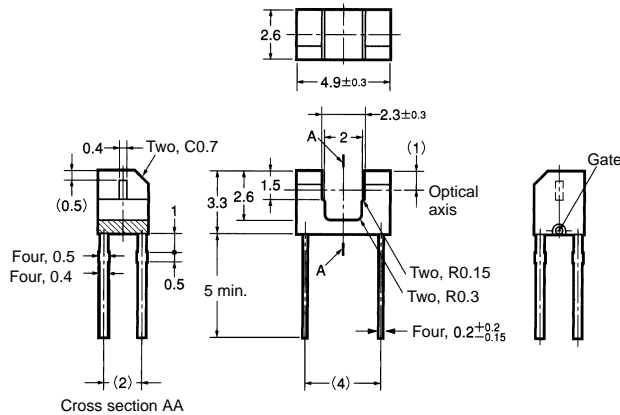

Terminal No.	Name
A	Anode
K	Cathode
C	Collector
E	Emitter

Unless otherwise specified, the tolerances are  $\pm 0.2$  mm.

### ■ Features

- Ultra-compact with a sensor width of 4.9 mm and a slot width of 2 mm.
- Low-height of 3.3 mm.
- PCB mounting type.
- High resolution with a 0.4-mm-wide aperture.

### ■ Absolute Maximum Ratings ( $T_a = 25^\circ\text{C}$ )

Item	Symbol	Rated value
Emitter	Forward current	$I_F$ 50 mA (see note 1)
	Pulse forward current	$I_{FP}$ ---
	Reverse voltage	$V_R$ 5 V
Detector	Collector–Emitter voltage	$V_{CEO}$ 30 V
	Emitter–Collector voltage	$V_{ECO}$ 4.5 V
	Collector current	$I_C$ 30 mA
	Collector dissipation	$P_C$ 80 mW (see note 1)
Ambient temperature	Operating	$T_{opr}$ $-25^\circ\text{C}$ to $85^\circ\text{C}$
	Storage	$T_{stg}$ $-30^\circ\text{C}$ to $85^\circ\text{C}$
Soldering temperature		$T_{sol}$ $260^\circ\text{C}$ (see note 2)

- Note:**
1. Refer to the temperature rating chart if the ambient temperature exceeds  $25^\circ\text{C}$ .
  2. Complete soldering within 3 seconds.

### ■ Electrical and Optical Characteristics ( $T_a = 25^\circ\text{C}$ )

Item	Symbol	Value	Condition
Emitter	Forward voltage	$V_F$ 1.3 V typ., 1.6 V max.	$I_F = 50$ mA
	Reverse current	$I_R$ 10 $\mu\text{A}$ max.	$V_R = 5$ V
	Peak emission wavelength	$\lambda_P$ 950 nm typ.	$I_F = 50$ mA
Detector	Light current	$I_L$ 0.2 mA min.	$I_F = 20$ mA, $V_{CE} = 5$ V
	Dark current	$I_D$ 500 nA max.	$V_{CE} = 10$ V, 0 lx
	Leakage current	$I_{LEAK}$ ---	---
	Collector–Emitter saturated voltage	$V_{CE}(\text{sat})$ 0.4 V max.	$I_F = 20$ mA, $I_L = 0.1$ mA
	Peak spectral sensitivity wavelength	$\lambda_P$ 800 nm typ.	$V_{CE} = 5$ V
Rising time	$t_r$ 10 $\mu\text{s}$ typ.	$V_{CC} = 5$ V, $R_L = 100$ $\Omega$ , $I_F = 20$ mA	
Falling time	$t_f$ 10 $\mu\text{s}$ typ.	$V_{CC} = 5$ V, $R_L = 100$ $\Omega$ , $I_F = 20$ mA	

Engineering Data

Forward Current vs. Collector Dissipation Temperature Rating

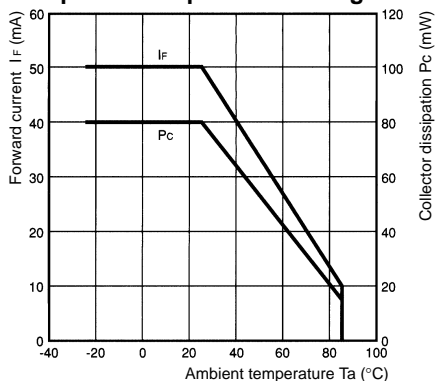

Forward Current vs. Forward Voltage Characteristics (Typical)

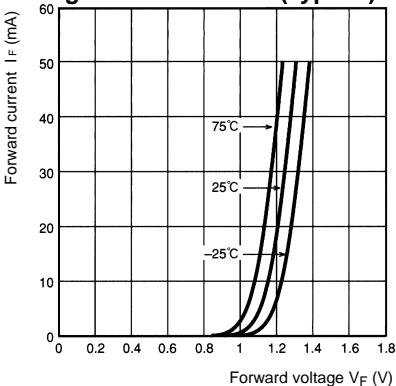

Light Current vs. Forward Current Characteristics (Typical)

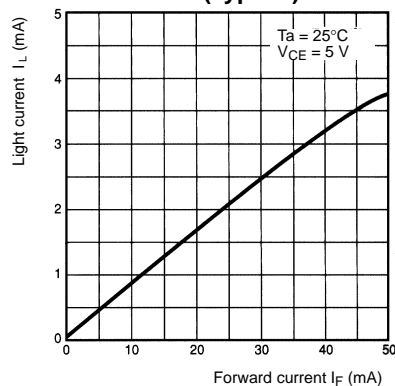

Light Current vs. Collector-Emitter Voltage Characteristics (Typical)

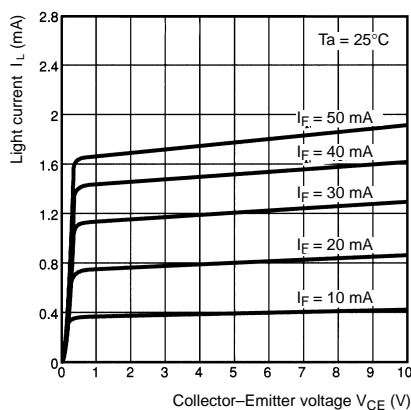

Relative Light Current vs. Ambient Temperature Characteristics (Typical)

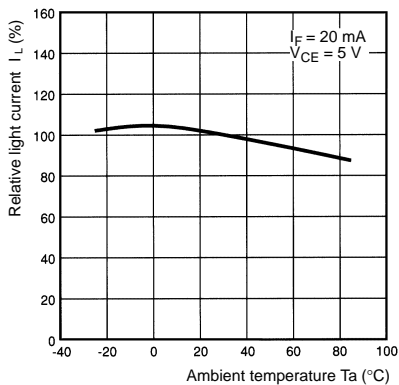

Dark Current vs. Ambient Temperature Characteristics (Typical)

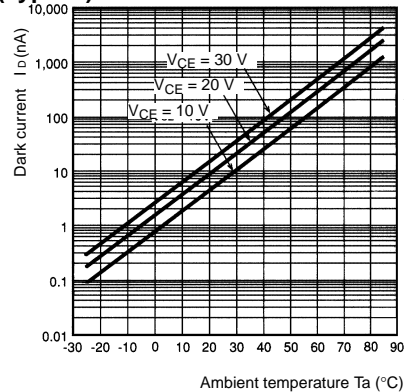

Response Time vs. Light Current Characteristics (Typical)

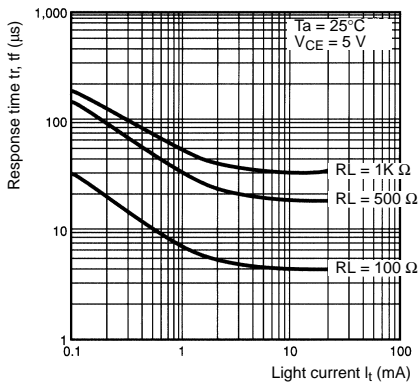

Sensing Position Characteristics (Typical)

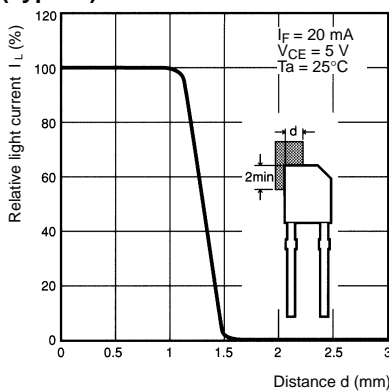

Sensing Position Characteristics (Typical)

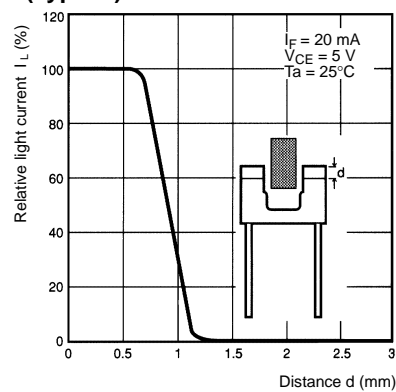

Response Time Measurement Circuit

