

S5 series

- Multivoltage from 15 to 264 Vac
- DC versions (10 to 30 Vdc)
- Green stability LED
- Light/dark selection
- Sensitivity control
- Straight or 90° optics
- Connection via cable or M12 connector
- Test input models
- Fibre optics versions
- Plastic casing - IP67

TECHNICAL DESCRIPTION

The **S5** 18 mm tubular photoelectric sensor series is available in the following versions:

- | | |
|--|------------------------------------|
| ■ <i>Retroreflex</i> | ■ <i>Limited proximity scanner</i> |
| ■ <i>Polarised retroreflex</i> | ■ <i>Fibre optics</i> |
| ■ <i>Proximity scanner</i> | ■ <i>Emitter/receiver</i> |
| ■ <i>Fixed focus proximity scanner</i> | |

The **S5** versions operating from 10 to 30 Vdc have dual NPN/PNP output and light/dark operation selection. These units are also short-circuit and reverse polarity protected. The multivoltage versions accept any voltage from 15 to 264 Vac and are supplied with SCR + bridge output.

A red output LED indicator is standard in all models. The DC versions of the series are provided with a green stability LED to control alignment and display the level of the received signal, a sensitivity control trimmer and test input function.

S5 sensors are enclosed in plastic casing, protection class IP67, straight or 90° optics. Electrical connection may be with a cable or using the M12 connector. Two or more sensors may be connected to activate simple logic configurations: AND, NOR, OR and NAND.

The wide range of models available suits these sensors to a variety of industrial applications requiring solutions to critical space and difficult access situations.

A MEK 18 mm glass filter is available to protect the lens when used in the presence of corrosive substances.

APPLICATIONS

- Automatic packaging machines
- Presence detection, counting
- Transport and conveyor lines
- Robotics and FMS applications
- Small object detection
- Space critical situations

FUNCTIONS

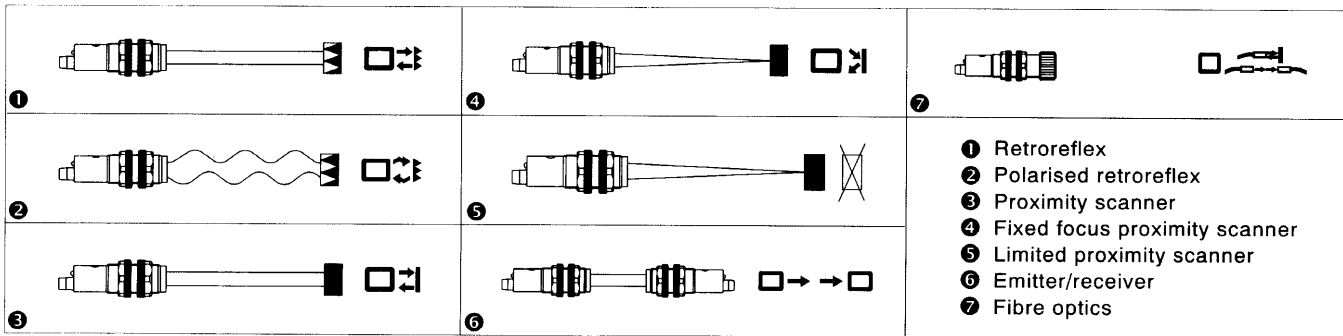

SPECIFICATIONS

Emission: Infrared LED 880 nm
 Red LED 660nm for fixed focus, proximity scanner and fibre optics versions
Lenses: PMMA Methacrylate
Indicators: red output LED
 green stability LED (DC versions with sensitivity control only)
Housing: plastic
Protection class: IP67
Weight: approx. 100 g. (3.53 oz)
Connections: 2 m cable or M12 connector
Operating temperature: -15 to +55°C (+5 to 131°F)
Storage temperature: -20 to +70°C (-4 to 158°F)
Humidity: 35 to 85% (non-condensing)
Ambient light rejection: 3,000 lux max., incandescent lamp
 10,000 lux max., sunlight
Vibration: 10 to 55 Hz, amplitude 1.5 mm (0.06 in) in each axes X, Y, Z for 2 hours
Shock resistance: 500 m/s (approx. 50 G)
 3 shocks in each 3 axes
Hysteresis: 10% max. (proximity versions only)
Light/dark selection: standard in all DC models, excluding limited proximity version (selectable by inverting the power supply wires)

AC versions

Power supply: 15 to 264 Vac, 48 to 62 Hz
Current consumption: 10 mA max.
Output: SCR + bridge rectifier - 264 Vac
Output current: 100 mA max.
Output leakage current: 1 mA max. at 264 Vac
Response time: 20 ms max.
Switching frequency: 25 Hz max.

DC versions

Power supply: 10 to 30 Vdc
 ripple: 2 Vpp max.
Current consumption: 30 mA max.
Output: NPN/PNP selectable 30Vdc max (excluding limited proximity version)
Output current: 150 mA max.
Short circuit protection: active at 200 mA
Saturation voltage: 2.5 V max. - NPN or PNP output
 1.2 V max. - limited proximity
Output leakage: 50 µA at 30 Vdc
Response time: 1 ms max. - standard
 2 ms - emitter/receiver
 6 ms - limited proximity
Switching frequency: 500 Hz max. - standard
 250 Hz - emitter/receiver
 175 Hz - limited proximity

AC VERSIONS: MODELS SELECTION TABLE

TYPE	FUNCTION OPERATING DISTANCE	DARK LIGHT PULSE	SENSITIVITY TRIMMER	Straight optic with standard cable	Straight optic with 90° cable	Straight optic with M12 connector	90° optic with standard cable	90° optic with M12 connector
S5-1-A2-10		dark		G5110210				
S5-1-A2-11		dark			G5110211			
S5-1-A2-12		dark				G5110212		
S5-1-A2-15	retroreflex	dark					G5110215	
S5-1-A2-17		dark						G5110217
S5-1-A2-20		light		G5110220				
S5-1-A2-21	0.1 to 2 m	light			G5110221			
S5-1-A2-22	(0.33 to 6.6 ft)	light				G5110222		
S5-1-A2-25		light					G5110225	
S5-1-A2-27		light						G5110227



FIBRE OPTICS: GENERAL INFORMATION

MATERIAL: PMMA fibre/polyethylene sheath
 TEMPERATURE: -30 to +60°C (-22 to +140°F)

Acrylic polymer fibre optic cables may be cut to desired length for particular applications using the cutting tool PLC-01 (code No. S8203517). However, this will reduce the operating range by 20%.

Note: Cutting tool is included with fibre optics type:
 OF-18/19/22/23/24.

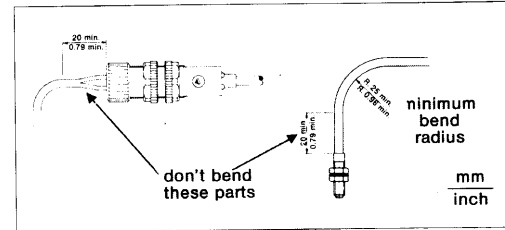

FIBRE OPTICS: MODELS SELECTION TABLE

TYPE	FUNCTION	OPERATING DISTANCE	LENGTH	ORDER NO.
OF-18	proximity scanner	2.2 cm (0.9 in)	1 m (3.3 ft)	G76021801
OF-19	emitter/receiver	8.5 cm (3.35 in)	1 m (3.3 ft)	G76021901
OF-20	proximity scanner	1.2 cm (0.47 in)	2 m (6.6 ft)	G76022000
OF-21	emitter/receiver	6.5 cm (2.6 in)	2 m (6.6 ft)	G76022100
OF-22	proximity scanner	2.2 cm (0.9 in)	2 m (6.6 ft)	G76022200
OF-23	emitter/receiver	8.5 cm (3.35 in)	2 m (6.6 ft)	G76022300
OF-24	proximity scanner	2.2 cm (0.9 in)	2 m (6.6 ft)	G76022400
OF-25	emitter/receiver	2.5 cm (0.98 in)	1 m (3.3 ft)	S76022500
OF-26	proximity scanner	0.5 cm (0.2 in)	1 m (3.3 ft)	S76022600
OF-28	proximity scanner	0.5 cm (0.2 in)	1 m (3.3 ft)	S76022800

FIBRE OPTICS: OVERALL DIMENSIONS

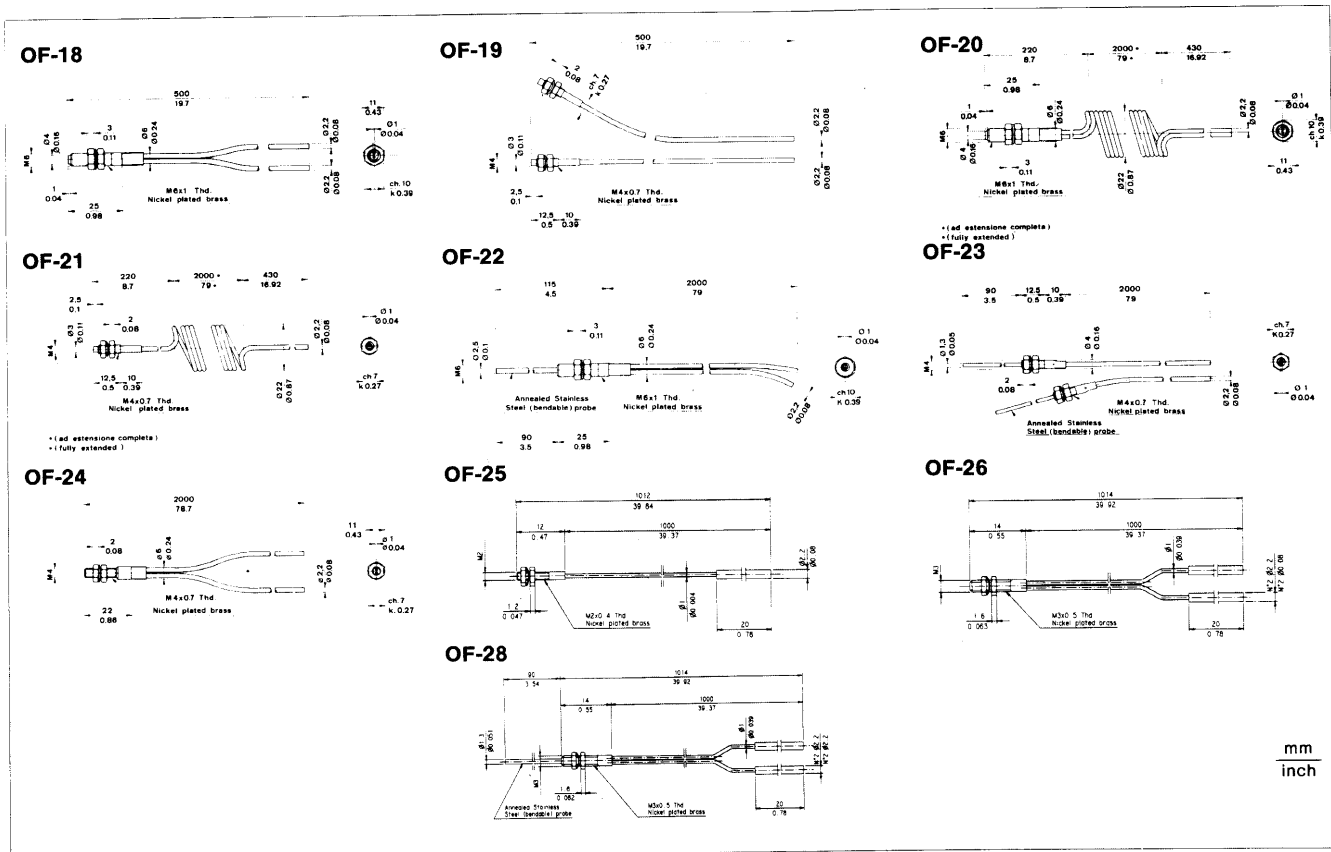

mm
inch



CHARACTERISTICS DIAGRAM: EFFECTIVE BEAM DIAMETER

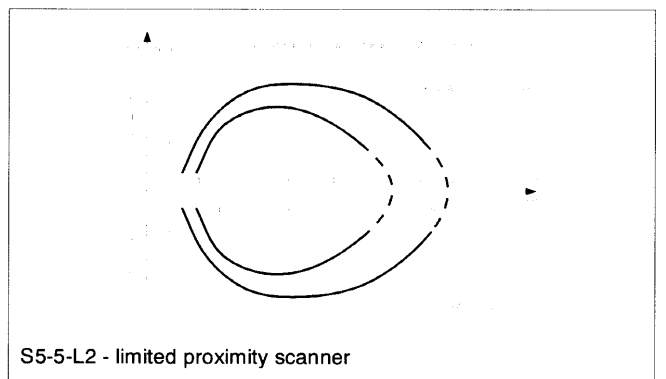
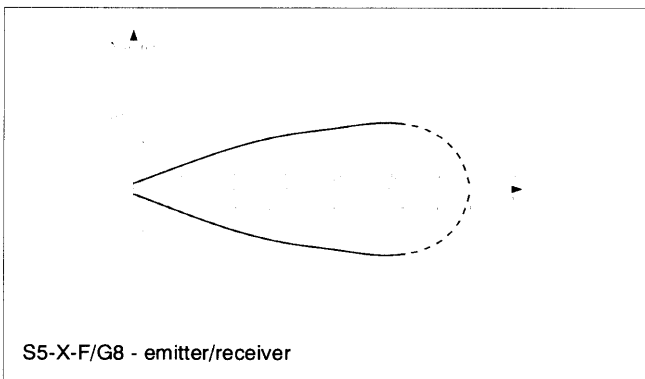
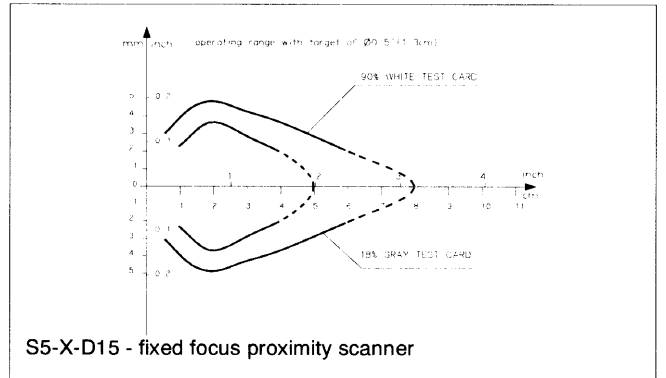
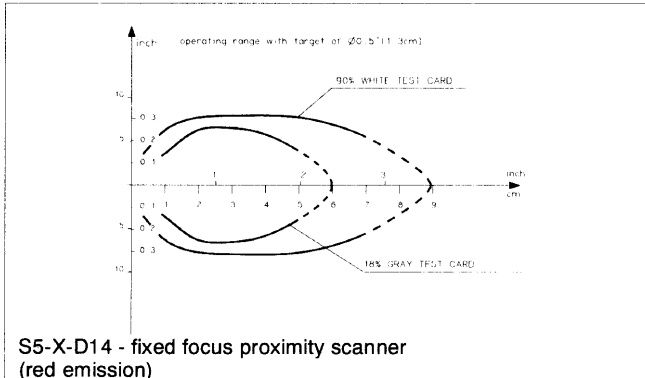
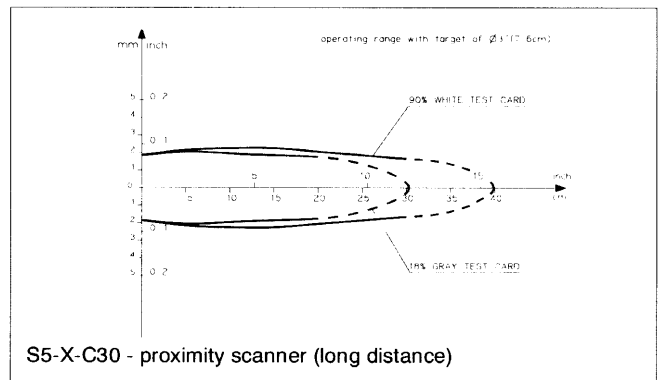
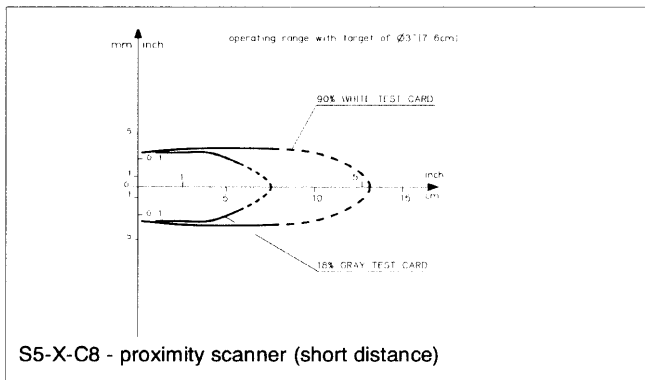
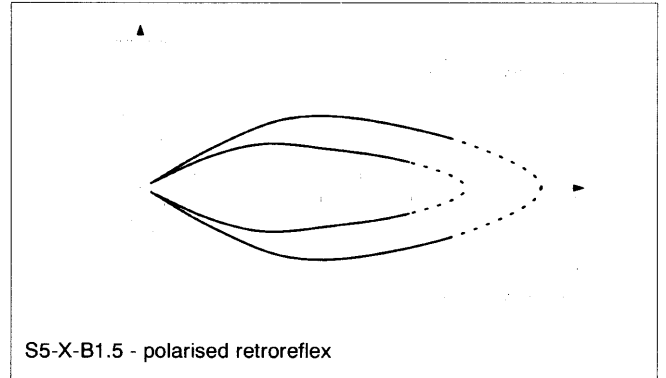
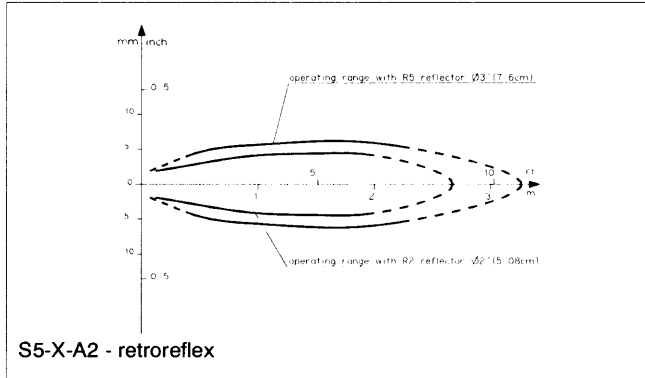

The standard values given for the operating ranges are referred to ideal conditions, i.e. clean air, clean lenses, etc. Dust, air pollution and other kinds of ambient contamination reduce the operating ranges.



FIBRE OPTICS: CHARACTERISTICS DIAGRAM - EFFECTIVE BEAM DIAMETER

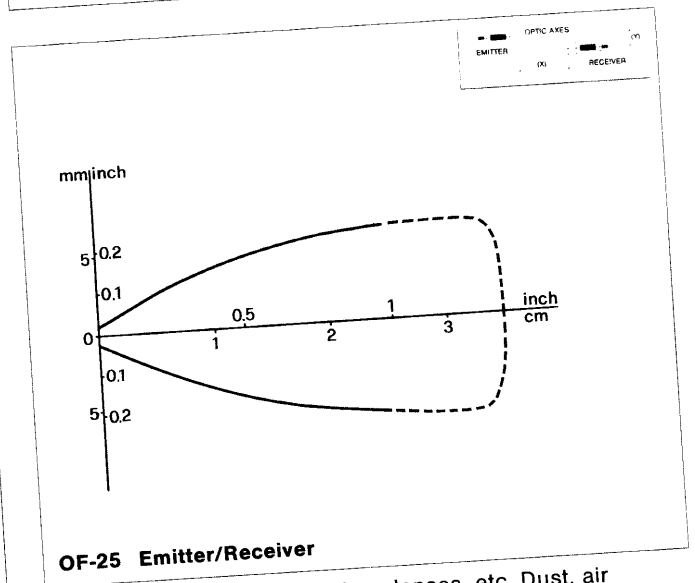
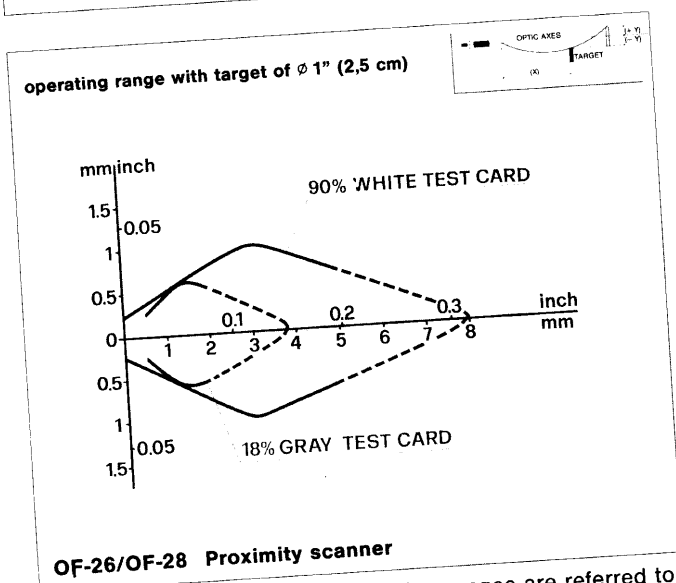
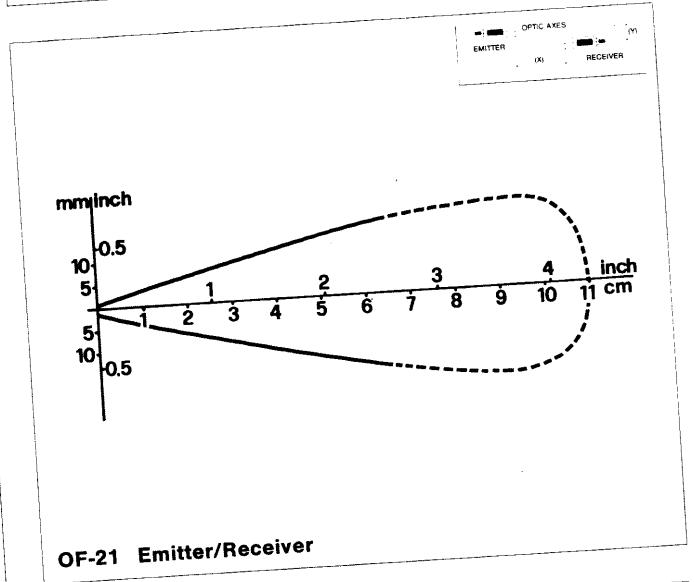
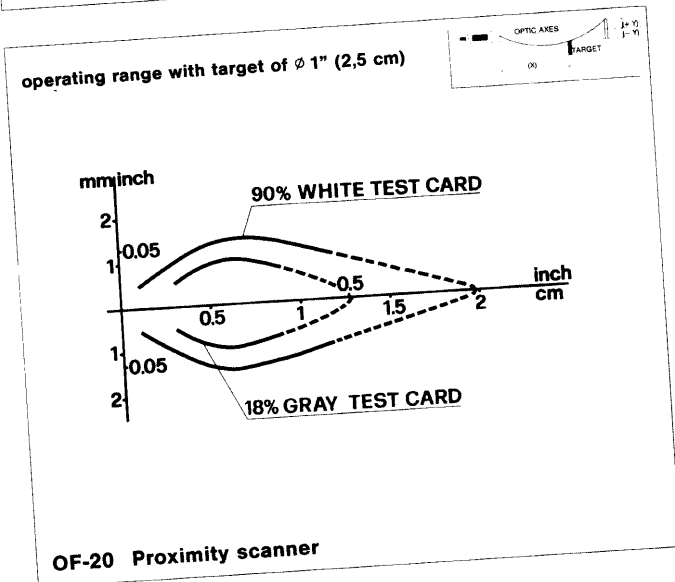
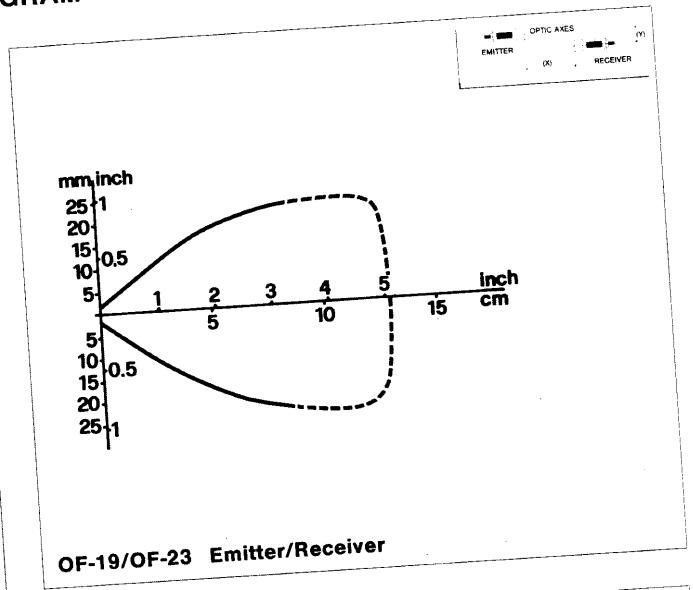
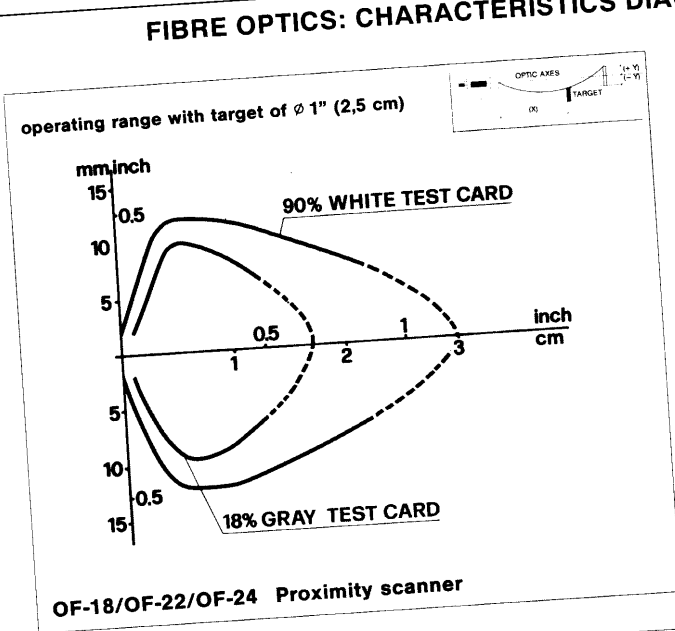

The standard values for the operating ranges are referred to ideal conditions, i.e. clean air, clean lenses, etc. Dust, air pollution and other kinds of ambient contamination reduce the operating ranges.



OVERALL DIMENSIONS

90° version

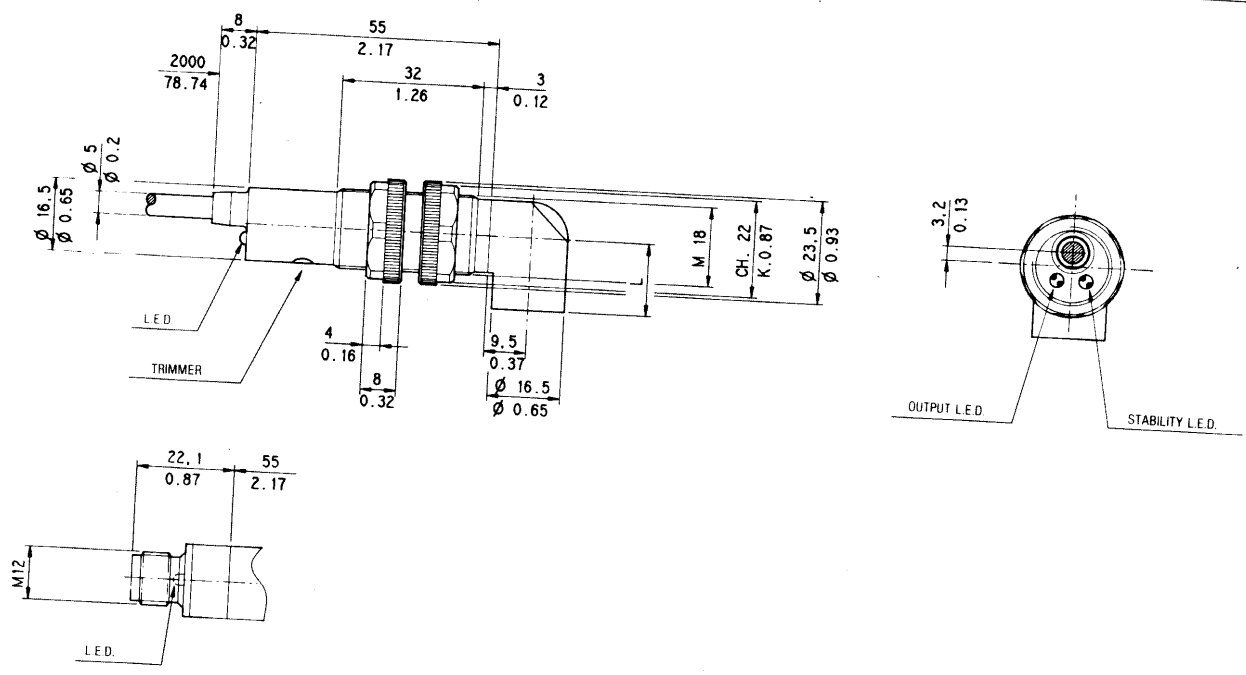

Length L	Emitter/Receiver	Other functions
16.5 mm (0.65")		•
20.5 mm (0.81")	•	•

ACCESSORIES

mounting bracket DI-95
(Order no. G71550095)

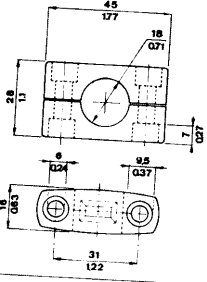

MEK-proof protection
(Order no. G5000001)

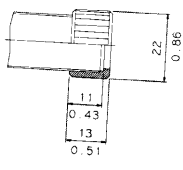

Reflector - R2
(Order no. S940700048)

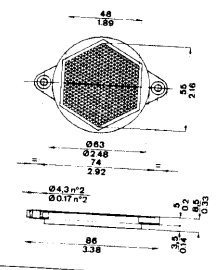

ACCESSORIES: M12 FLYING FEMALE CONNECTORS

Flying connector						
Without cable	G5085002	G5085003	-	-	BINDER	BINDER
With 2 m cable - PUR	-	-	G5085004	-	G5085005	-
DC-4 wires	-	-	-	-	-	-
AC-3 wires	-	-	-	G5085006*	-	G5085007



OVERALL DIMENSIONS

Straight version

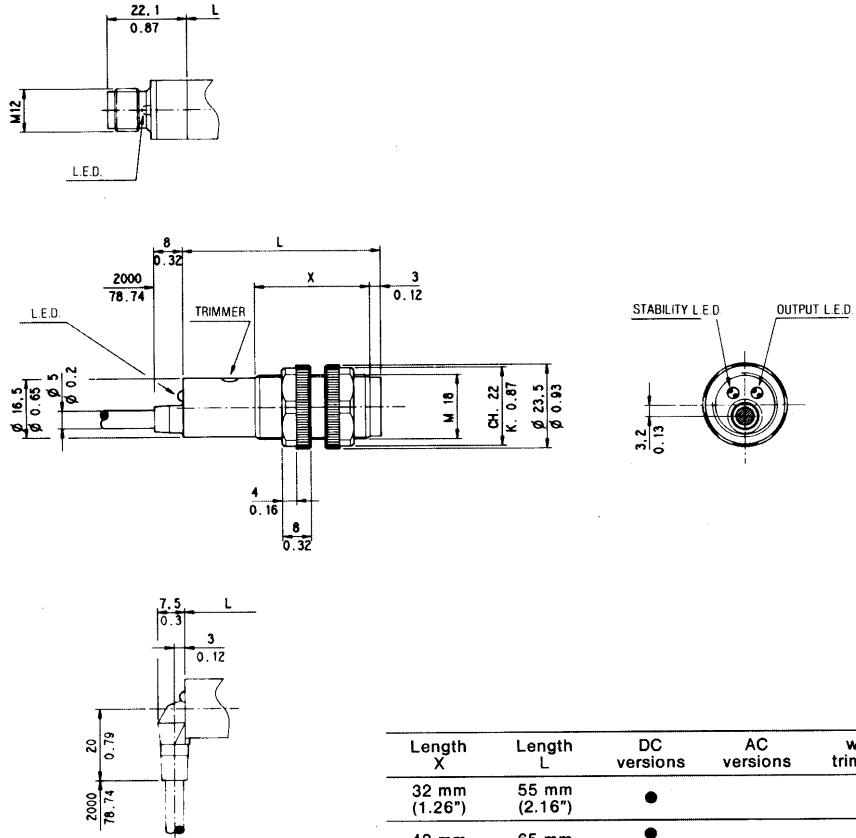

Length X	Length L	DC versions	AC versions	with trimmer	without trimmer
32 mm (1.26")	55 mm (2.16")	●			●
42 mm (1.65")	65 mm (2.56")	●	●	●	●
52 mm (2.05")	75 cm (2.95")		●	●	

Fibre optic version

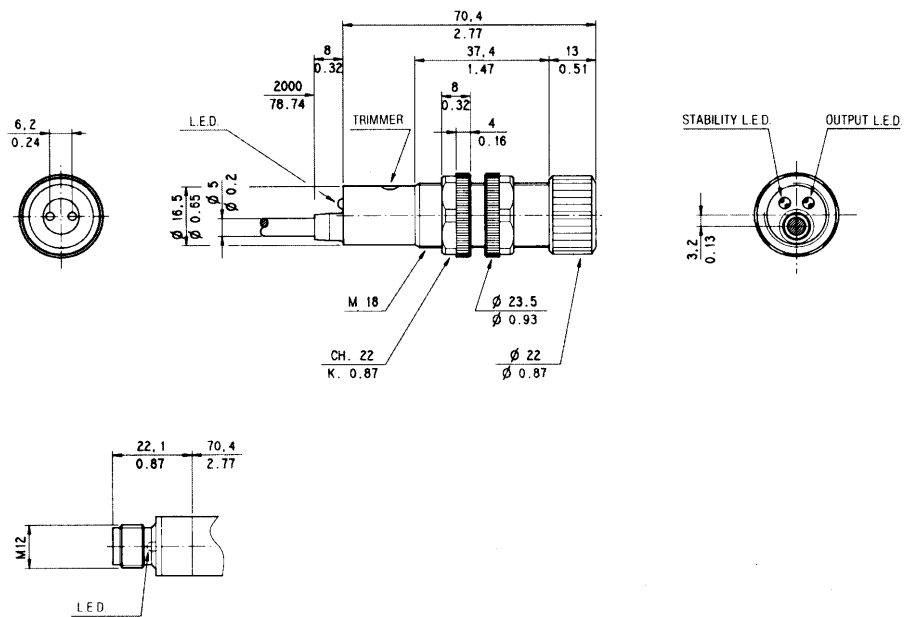

mm
inch



MODEL DESCRIPTION

S5 - X - XXX - X X

1 AC power supply	A2 retroreflex	0 no pulse selection	0 straight optics, straight cable
5 DC power supply	B1,5 polarised retroreflex	1 dark pulse, 3 wires, AC	1 straight optics, 90° cable
	C8 prox. scanner (short dist.)	2 light pulse, 3 wires, AC	2 straight optics, M12 connector
	C30 prox. scanner (long dist.)	3 dark/light pulse, 4 wires, DC	5 90° optics, straight cable
	D14 fix. focus prox. scanner R	6 dark pulse, 3 wires, DC, NPN	7 90° optics, M12 connector
	D15 fix. focus prox. scanner IR	7 light pulse, 3 wires, DC, NPN	
	E1 fibre optics R	8 dark pulse, 3 wires, DC, PNP	
	F8 receiver	9 light pulse, 3 wires, DC, PNP	
	G8 emitter		
	L2 limited prox. scanner		

CONNECTIONS

DC Type

Light-Mode NPN

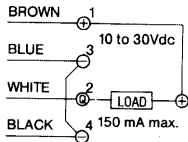

Light-Mode PNP

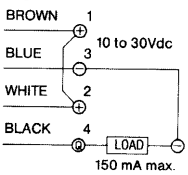

Dark-Mode NPN

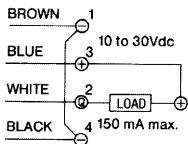

Dark-Mode PNP

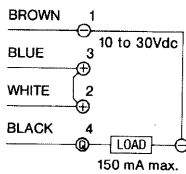

DC emitter only

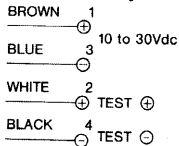

S5 with M12 male connector

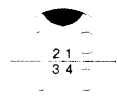

AC Type

AC emitter only

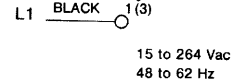

N BLUE 2 (1)

AC other models

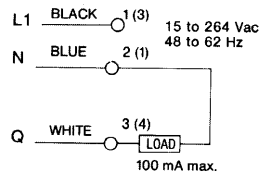

M12-(M18)

S5 with M12 male connector

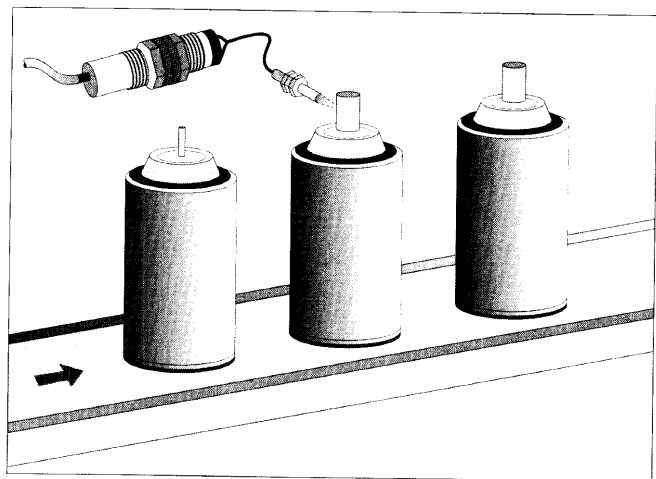
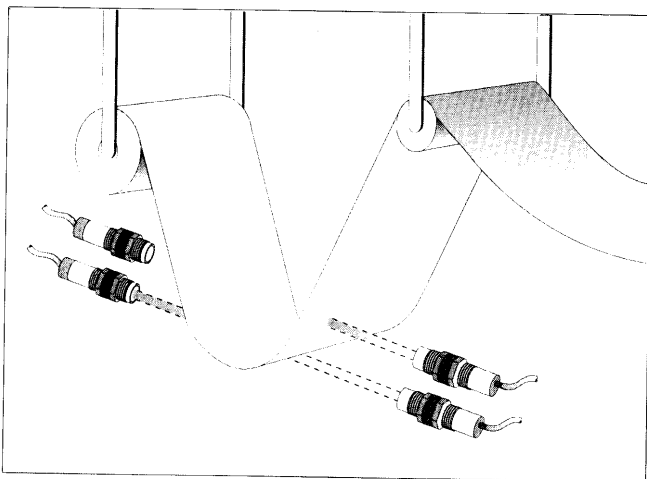
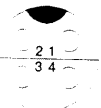

We reserve the right to make modifications and improvements



DC VERSIONS: MODELS SELECTION TABLE

TYPE	FUNCTION OPERATING DISTANCE	TEST INPUT FUNCTION	SENSITIVITY TRIMMER STABILITY LED	straight optic with standard cable	straight optic with 90° cable	straight optic with M12 connector	90° optic with standard cable	90° optic with M12 connector
S5-5-A2-30				G5210230				
S5-5-A2-31	retroreflex				G5210231			
S5-5-A2-32	0.1 to 2 m					G5210232		
S5-5-A2-35	(0.33 to 6.6 ft)						G5210235	
S5-5-A2-37								G5210237
S5-5-B1,5-30	polarised			G5210730				
S5-5-B1,5-32	retroreflex					G5210732		
S5-5-B1,5-35	0.1 to 1.5 m						G5210735	
S5-5-B1,5-37	(0.33 to 5 ft)							G5210737
S5-5-C8-30				G5210530				
S5-5-C8-31	proximity scanner				G5210531			
S5-5-C8-32	(short distance)					G5210532		
S5-5-C8-35	80 mm (3.15 in)						G5210535	
S5-5-C8-37								G5210537
S5-5-C30-30			•	G5210630				
S5-5-C30-31	proximity scanner		•		G5210631			
S5-5-C30-32	(long distance)		•			G5210632		
S5-5-C30-35	300 mm (11.8 in)		•				G5210635	
S5-5-C30-37			•					G5210637
S5-5-D14-30	fix. foc. prox. scan.		•	G5210310				
S5-5-D14-31	(red emission)		•		G5210311			
S5-5-D14-32	14 mm (0.55 in)		•			G5210312		
S5-5-D15-30	fixed focus			G5210430				
S5-5-D15-31	proximity scanner				G5210431			
S5-5-D15-32	15 mm (0.6 in)					G5210432		
S5-5-E1-30	fibre optics		•	G5210830				
S5-5-E1-32	(red emission)		•			G5210832		
S5-5-G8-00		•		G5210000				
S5-5-G8-01	emitter	•			G5210001			
S5-5-G8-02		•				G5210002		
S5-5-G8-05	8 m (26.25 ft)	•					G5210005	
S5-5-G8-07		•						G5210007
S5-5-F8-30				G5210130				
S5-5-F8-31	receiver				G5210131			
S5-5-F8-32						G5210132		
S5-5-F8-35	8 m (26.25 ft)						G5210135	
S5-5-F8-37								G5210137
S5-5-L2-60				G5210960				
S5-5-L2-62						G5210962		
S5-5-L2-65							G5210965	
S5-5-L2-67								G5210967
S5-5-L2-70				G5210970				
S5-5-L2-72	limited					G5210972		
S5-5-L2-75	proximity scanner						G5210975	
S5-5-L2-77								G5210977
S5-5-L2-80				G5210980				
S5-5-L2-82						G5210982		
S5-5-L2-85	15 mm (0.59 in)						G5210985	
S5-5-L2-87								G5210987
S5-5-L2-90				G5210990				
S5-5-L2-92						G5210992		
S5-5-L2-95							G5210995	
S5-5-L2-97								G5210997



AC VERSIONS: MODELS SELECTION TABLE (cont...)

TYPE	FUNCTION OPERATING DISTANCE	DARK LIGHT PULSE	SENSITIVITY TRIMMER	straight optic with standard cable	straight optic with 90° cable	straight optic with M12 connector	90° optic with standard cable	90° optic with M12 connector
S5-1-B1.5-10		dark		G5110710				
S5-1-B1.5-11		dark			G5110711			
S5-1-B1.5-12		dark				G5110712		
S5-1-B1.5-15	polarised	dark					G5110715	
S5-1-B1.5-17	retroreflex	dark						G5110717
S5-1-B1.5-20		light		G5110720				
S5-1-B1.5-21	0.1 to 1.5 m	light			G5110721			
S5-1-B1.5-22	(0.33 to 5 ft)	light				G5110722		
S5-1-B1.5-25		light					G5110725	
S5-1-B1.5-27		light						G5110727
S5-1-C8-10		dark		G5110510				
S5-1-C8-11		dark			G5110511			
S5-1-C8-12	proximity	dark				G5110512		
S5-1-C8-15	scanner	dark					G5110515	
S5-1-C8-17	(short distance)	dark						G5110517
S5-1-C8-20		light		G5110520				
S5-1-C8-21	80 mm	light			G5110521			
S5-1-C8-22	(3.15 in)	light				G5110522		
S5-1-C8-25		light					G5110525	
S5-1-C8-27		light						G5110527
S5-1-C30-10		dark	.	G5110610				
S5-1-C30-11		dark	.		G5110611			
S5-1-C30-12	proximity	dark	.			G5110612		
S5-1-C30-15	scanner	dark	.				G5110615	
S5-1-C30-17	(long distance)	dark	.					G5110617
S5-1-C30-20		light	.	G5110620				
S5-1-C30-21	300 mm	light	.		G5110621			
S5-1-C30-22	(11.8 in)	light	.			G5110622		
S5-1-C30-25		light	.				G5110625	
S5-1-C30-27		light	.					G5110627
S5-1-D14-10	fixed focus	dark	.	G5110310				
S5-1-D14-11	proximity	dark	.		G5110311			
S5-1-D14-12	scanner	dark	.			G5110312		
S5-1-D14-20	(red emission)	light	.	G5110320				
S5-1-D14-21	14 mm	light	.		G5110321			
S5-1-D14-22	(0.55 in)	light	.			G5110322		
S5-1-D15-10	fixed focus	dark		G5110410				
S5-1-D15-11	proximity	dark			G5110411			
S5-1-D15-12	scanner	dark				G5110412		
S5-1-D15-20		light		G5110420				
S5-1-D15-21	15 mm	light			G5110421			
S5-1-D15-22	(0.6 in)	light				G5110422		
S5-1-E1-10		dark	.	G5110810				
S5-1-E1-12	fibre optics	dark	.			G5110812		
S5-1-E1-20	(red emission)	light	.	G5110820				
S5-1-E1-22		light	.			G5110822		
S5-1-G8-00				G5110000				
S5-1-G8-01	emitter				G5110001			
S5-1-G8-02						G5110002		
S5-1-G8-05	8 m (26.25 ft)						G5110005	
S5-1-G8-07								G5110007
S5-1-F8-10		dark	.	G5110110				
S5-1-F8-11		dark	.		G5110111			
S5-1-F8-12		dark	.			G5110112		
S5-1-F8-15	receiver	dark	.				G5110115	
S5-1-F8-17		dark	.					G5110117
S5-1-F8-20		light	.	G5110120				
S5-1-F8-21	8 m (26.25 ft)	light	.		G5110121			
S5-1-F8-22		light	.			G5110122		
S5-1-F8-25		light	.				G5110125	
S5-1-F8-27		light	.					G5110127

