

2nd Generation thinQ!TM SiC Schottky Diode

Features

- Revolutionary semiconductor material - Silicon Carbide
- Switching behavior benchmark
- No reverse recovery/ No forward recovery
- No temperature influence on the switching behavior
- High surge current capability
- Pb-free lead plating; RoHS compliant
- Qualified according to JEDEC¹⁾ for target applications
- Breakdown voltage tested at 5mA²⁾

Product Summary

V_{DC}	600	V
Q_c	19	nC
I_F	8	A

PG-TO220-2-2

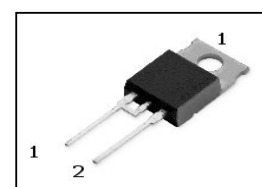

thinQ! 2G Diode specially designed for fast switching applications like:

- CCM PFC
- Motor Drives

Type	Package	Marking	Pin 1	Pin 2
IDT08S60C	PG-TO220-2-2	D08S60C	C	A

Maximum ratings, at $T_j=25\text{ °C}$, unless otherwise specified

Parameter	Symbol	Conditions	Value	Unit
Continuous forward current	I_F	$T_C < 140\text{ °C}$	8	A
RMS forward current	$I_{F,RMS}$	$f=50\text{ Hz}$	12	
Surge non-repetitive forward current, sine halfwave	$I_{F,SM}$	$T_C=25\text{ °C}$, $t_p=10\text{ ms}$	59	
Repetitive peak forward current	$I_{F,RM}$	$T_j=150\text{ °C}$, $T_C=100\text{ °C}$, $D=0.1$	32	
Non-repetitive peak forward current	$I_{F,max}$	$T_C=25\text{ °C}$, $t_p=10\text{ }\mu\text{s}$	264	
i^2t value	$\int i^2 dt$	$T_C=25\text{ °C}$, $t_p=10\text{ ms}$	17	A ² s
Repetitive peak reverse voltage	V_{RRM}		600	V
Diode dv/dt ruggedness	dv/dt	$V_R=0\dots 480\text{V}$	50	V/ns
Power dissipation	P_{tot}	$T_C=25\text{ °C}$	75	W
Operating and storage temperature	T_j , T_{stg}		-55 ... 175	°C
Mounting torque		M3 and M3.5 screws	60	Ncm

Parameter	Symbol	Conditions	Values			Unit
			min.	typ.	max.	
Thermal characteristics						
Thermal resistance, junction - case	R_{thJC}		-	-	2	K/W
Thermal resistance, junction - ambient	R_{thJA}	leaded	-	-	62	
Soldering temperature, wavesoldering only allowed at leads	T_{sold}	1.6mm (0.063in.) from case for 10s	-	-	260	°C

Electrical characteristics, at $T_j=25\text{ °C}$, unless otherwise specified

Static characteristics

DC blocking voltage	V_{DC}	$I_R=0.1\text{ mA}$	600	-	-	V
Diode forward voltage	V_F	$I_F=8\text{ A}, T_j=25\text{ °C}$	-	1.5	1.7	
		$I_F=8\text{ A}, T_j=150\text{ °C}$	-	1.7	2.1	
Reverse current	I_R	$V_R=600\text{ V}, T_j=25\text{ °C}$	-	1	100	μA
		$V_R=600\text{ V}, T_j=150\text{ °C}$	-	4	1000	

AC characteristics

Total capacitive charge	Q_c	$V_R=400\text{ V}, I_F \leq I_{F,max},$ $di_F/dt=200\text{ A}/\mu\text{s},$	-	19	-	nC
Switching time ³⁾	t_c	$T_j=150\text{ °C}$	-	-	<10	ns
Total capacitance	C	$V_R=1\text{ V}, f=1\text{ MHz}$	-	310	-	pF
		$V_R=300\text{ V}, f=1\text{ MHz}$	-	50	-	
		$V_R=600\text{ V}, f=1\text{ MHz}$	-	50	-	

¹⁾ J-STD20 and JESD22

²⁾ All devices tested under avalanche conditions, for a time periode of 5ms, at 5 mA.

³⁾ t_c is the time constant for the capacitive displacement current waveform (independent from T_j , I_{LOAD} and di/dt), different from t_{rr} which is dependent on T_j , I_{LOAD} and di/dt . No reverse recovery time constant t_{rr} due to absence of minority carrier injection.

⁴⁾ Only capacitive charge occuring, guaranteed by design

1 Power dissipation

$$P_{tot} = f(T_C)$$

parameter: $R_{thJC(max)}$

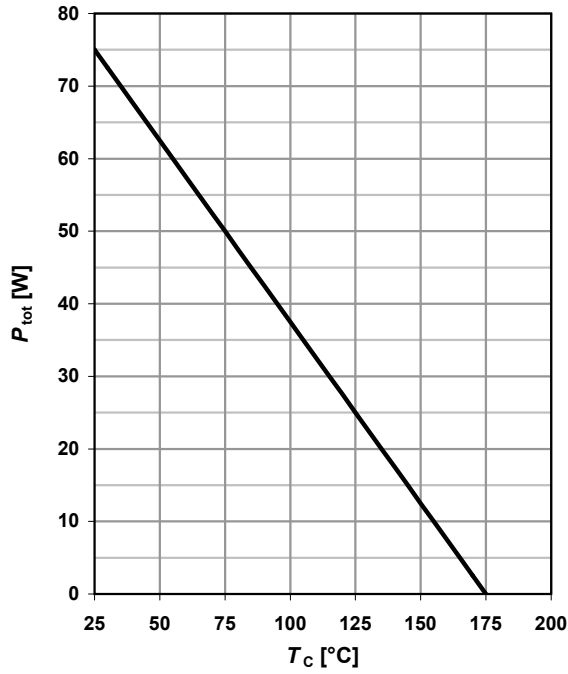

2 Diode forward current

$$I_F = f(T_C); T_j \leq 175 \text{ °C}$$

parameter: $R_{thJC(max)}$; $V_{F(max)}$

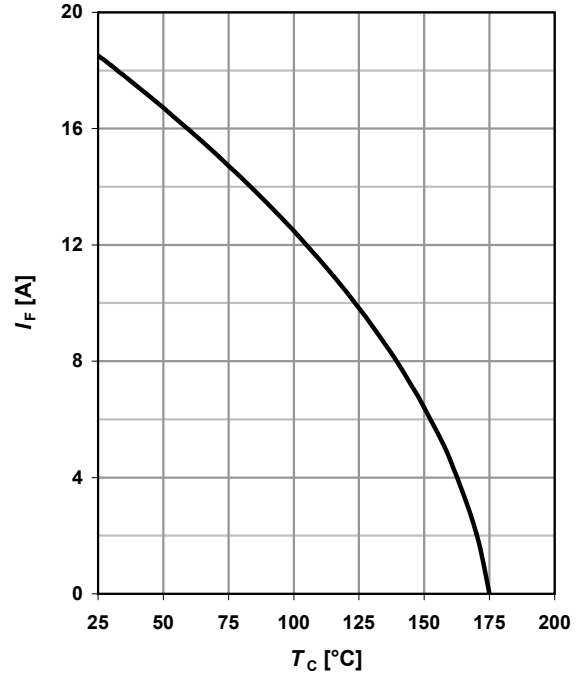

3 Typ. forward characteristic

$$I_F = f(V_F); t_p = 400 \mu s$$

parameter: T_j

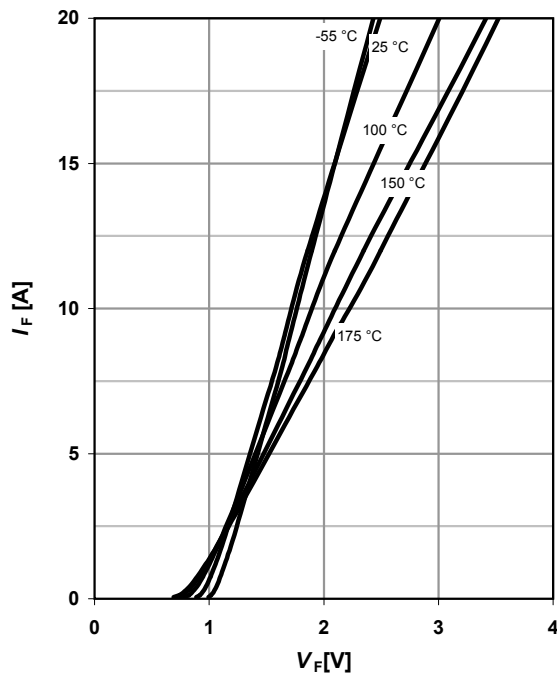

4 Typ. forward characteristic in surge current mode

$$I_F = f(V_F); t_p = 400 \mu s; \text{ parameter: } T_j$$

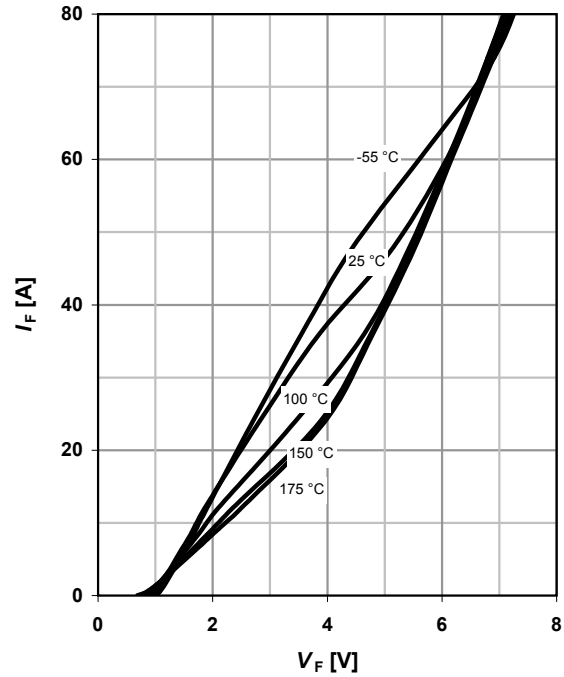

5 Typ. forward power dissipation vs. average forward current

$P_{F,AV}=f(I_F)$, $T_C=100\text{ }^\circ\text{C}$, parameter: $D=t_p/T$

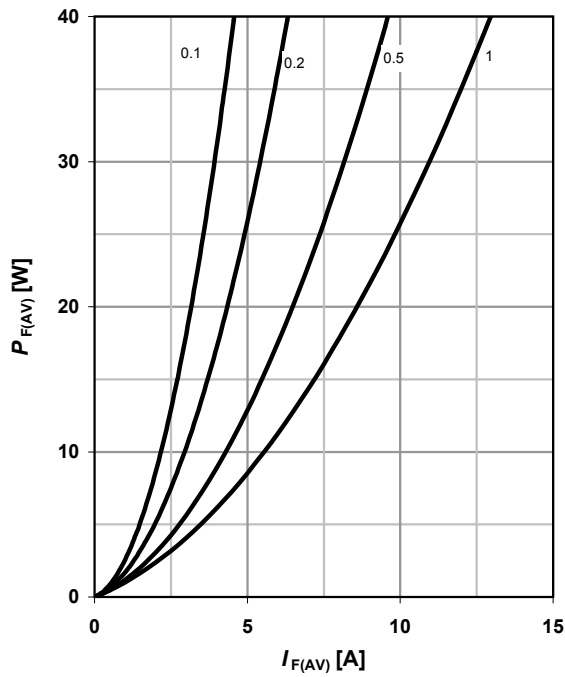

6 Typ. reverse current vs. reverse voltage

$I_R=f(V_R)$

parameter: T_j

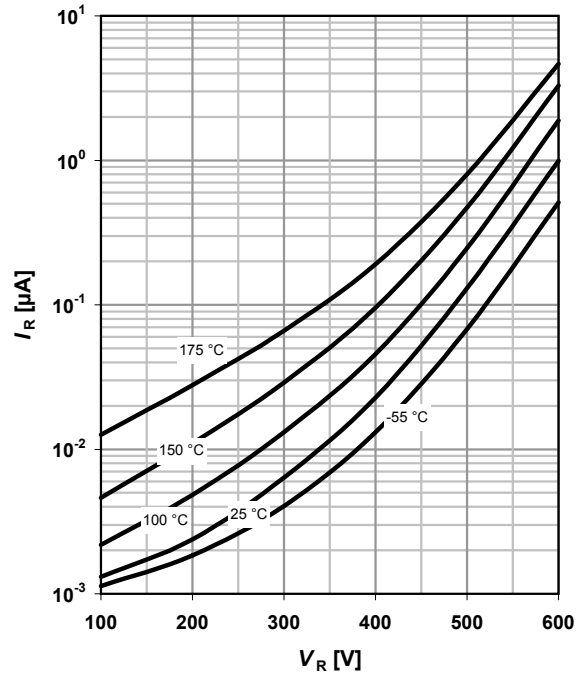

7 Transient thermal impedance

$Z_{thJC}=f(t_p)$

parameter: $D=t_p/T$

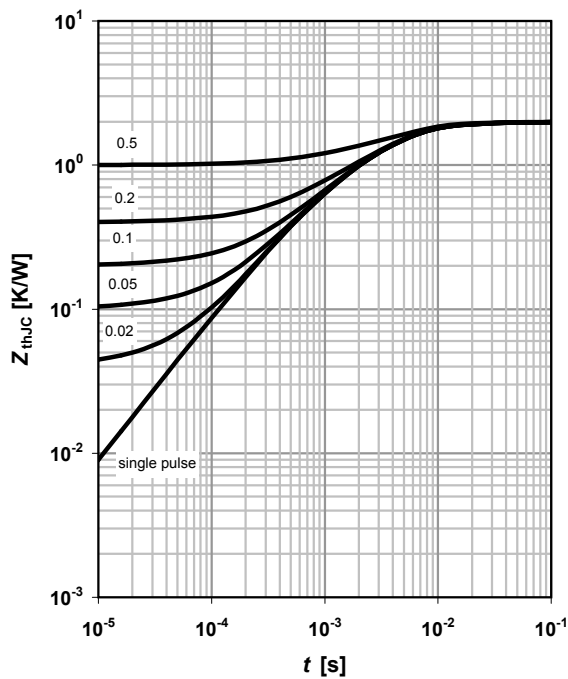

8 Typ. capacitance vs. reverse voltage

$C=f(V_R)$; $T_C=25\text{ }^\circ\text{C}$, $f=1\text{ MHz}$

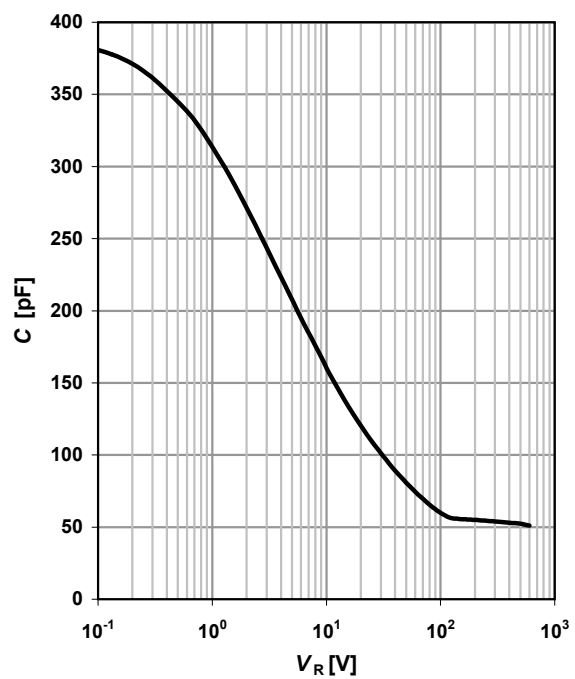

9 Typ. C stored energy

$$E_C = f(V_R)$$

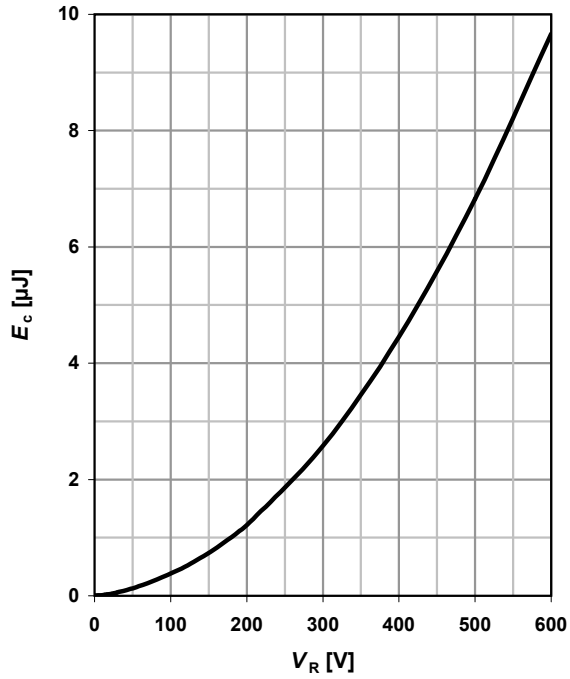

10 Typ. capacitance charge vs. current slope

$$Q_C = f(di_F/dt)^4; T_J = 150\text{ °C}; I_F \leq I_{F,max}$$

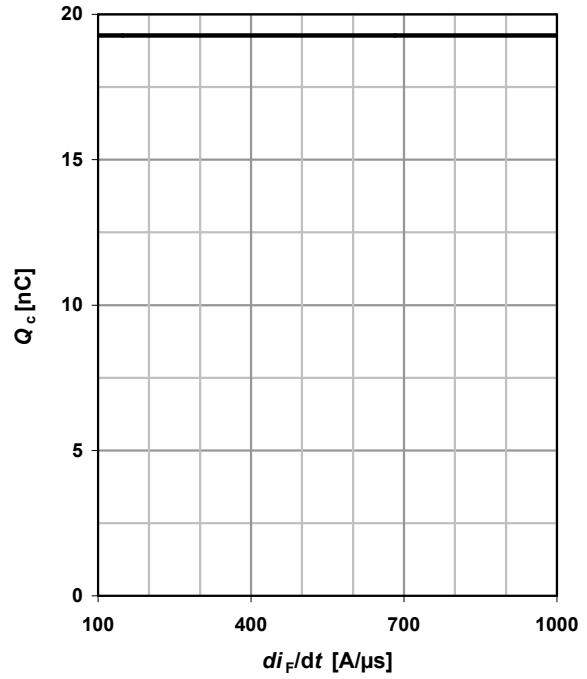

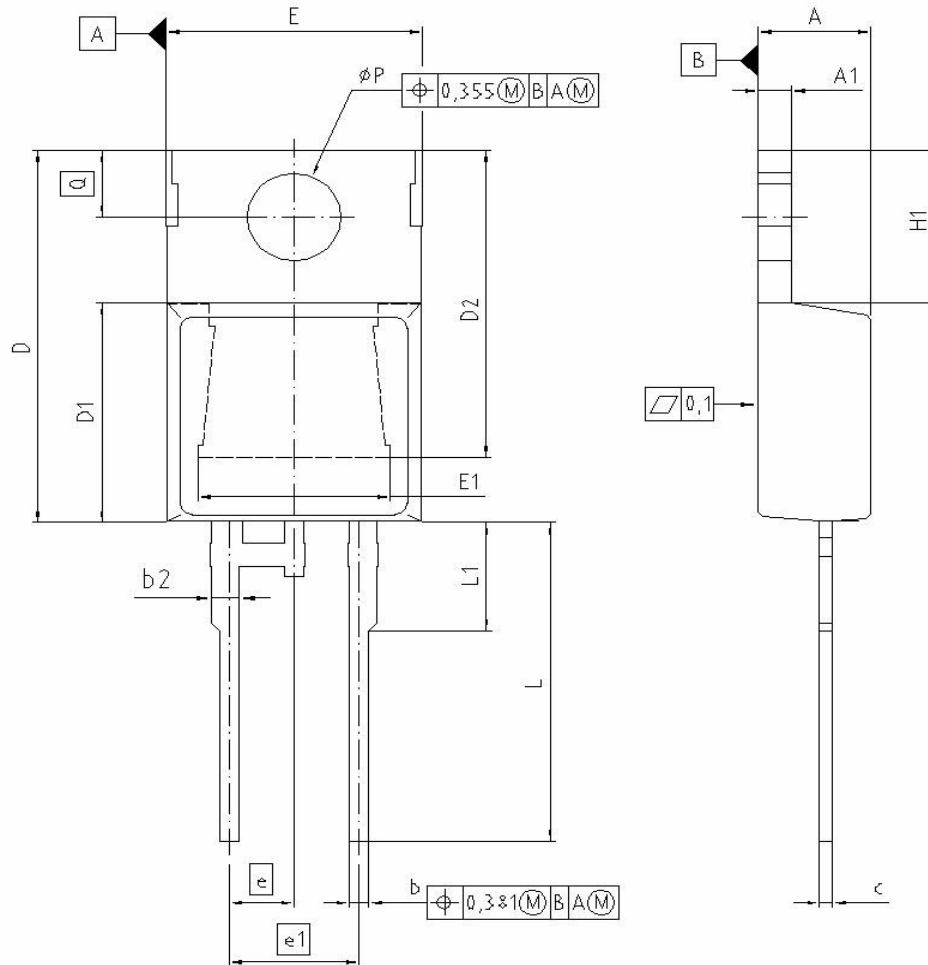
Package Outline: PG-TO220-2-2

DIM	MILLIMETERS		INCHES	
	MIN	MAX	MIN	MAX
A	4.191	4.699	0.165	0.185
A1	1.170	1.400	0.046	0.055
A2	2.215	2.718	0.087	0.107
b	0.635	0.889	0.025	0.035
b2	0.950	1.651	0.037	0.065
c	0.330	0.635	0.013	0.025
D	14.808	15.950	0.583	0.628
D1	8.509	9.450	0.335	0.372
D2	12.850	14.245	0.506	0.561
E	9.677	10.363	0.381	0.408
E1	6.500	8.788	0.256	0.346
e	2.540		0.100	
e1	5.080		0.200	
N	2		2	
H1	5.900	6.900	0.232	0.272
L	12.700	14.000	0.500	0.551
L1	3.048	4.800	0.120	0.189
ϕP	3.550	3.886	0.140	0.153
Q	2.540	3.048	0.100	0.120

REFERENCE J..
SCALE 0 2.5 5mm
EUROPEAN PROJECTION
ISSUE DATE 04-10-2005
FILE TO220_3

Published by
Infineon Technologies AG
81726 München, Germany

© Infineon Technologies AG 2006.
All Rights Reserved.

Attention please!

The information herein is given to describe certain components and shall not be considered as warranted characteristics.

Terms of delivery and rights to technical change reserved.

We hereby disclaim any and all warranties, including but not limited to warranties of non-infringement, regarding circuits, descriptions and charts stated herein.

Infineon Technologies is an approved CECC manufacturer.

Information

For further information on technology, delivery terms and conditions and prices, please contact your nearest Infineon Technologies office in Germany or our Infineon Technologies representatives worldwide (see address list).

Warnings

Due to technical requirements, components may contain dangerous substances.
For information on the types in question, please contact your nearest Infineon Technologies office.

Infineon Technologies' components may only be used in life-support devices or systems with the expressed written approval of Infineon Technologies if a failure of such components can reasonably be expected to cause the failure of that life-support device or system, or to affect the safety or effectiveness of that device or system. Life support devices or systems are intended to be implanted in the human body, or to support and/or maintain and sustain and/or protect human life. If they fail, it is reasonable to assume that the health of the user or other persons may be endangered.