

Recess head/Conical screw  
 260-8601-013  
 Material: Messing/brass  
 Oberfläche/finish: Nickel/nickel plated  
 je 2 Stück pro Verwendung/2 pcs. each per application

105 852

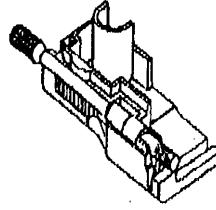
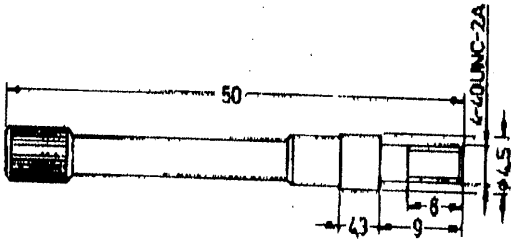

Schraubverriegelung/Jackscrew assembly  
 D121073-10  
 Material: Messing/brass  
 Oberfläche/finish: Nickel/nickel plated  
 je 2 Stück pro Verwendung/2 pcs. each per application

Vierkanmutter/Rectangular nut

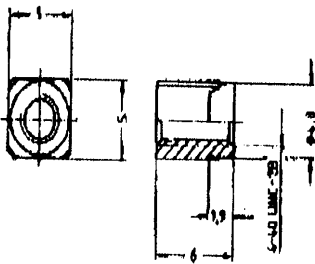

Mutterbolzen/Jack post

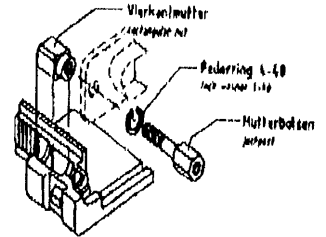
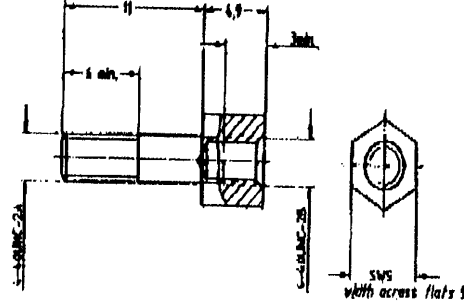

Schraube/Jackscrew  
 kurz/recessed head 260-8601-004  
 je 2 Stück pro Verwendung/2 pcs. each per application

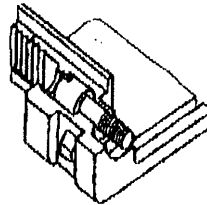
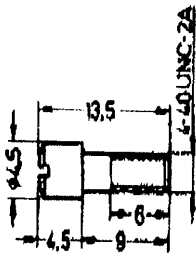

Schraube/Jackscrew  
 lang/non recessed head 260-8601-010  
 Material: Messing/brass  
 Oberfläche/finish: Nickel/nickel plated  
 je 2 Stück pro Verwendung/2 pcs. each per application

-009 = M3  
 (-013 = M3)

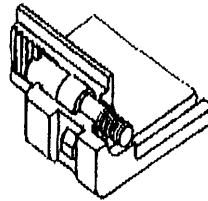
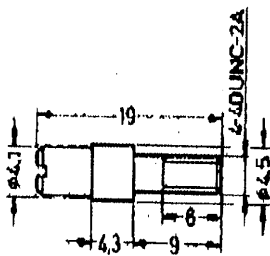

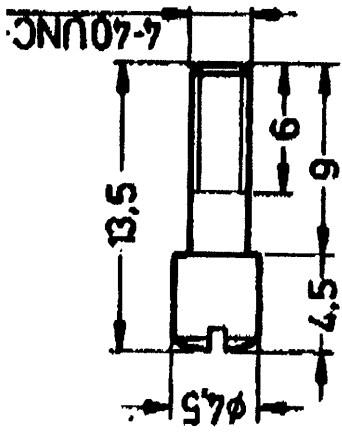

- 009 = M3  
 (- 013 = M3)

Schraube/Jackscrew  
 lang/non recessed head 250-8501-010  
 Material: Messing/brass  
 Oberfläche/finish: Nickel/nickel plated  
 je 2 Stück pro Verwendung/2 pcs. each per application

