

"Schutzvermerk nach DIN ISO 16016 beachten" "Please pay attention to copyright note DIN ISO 16016"

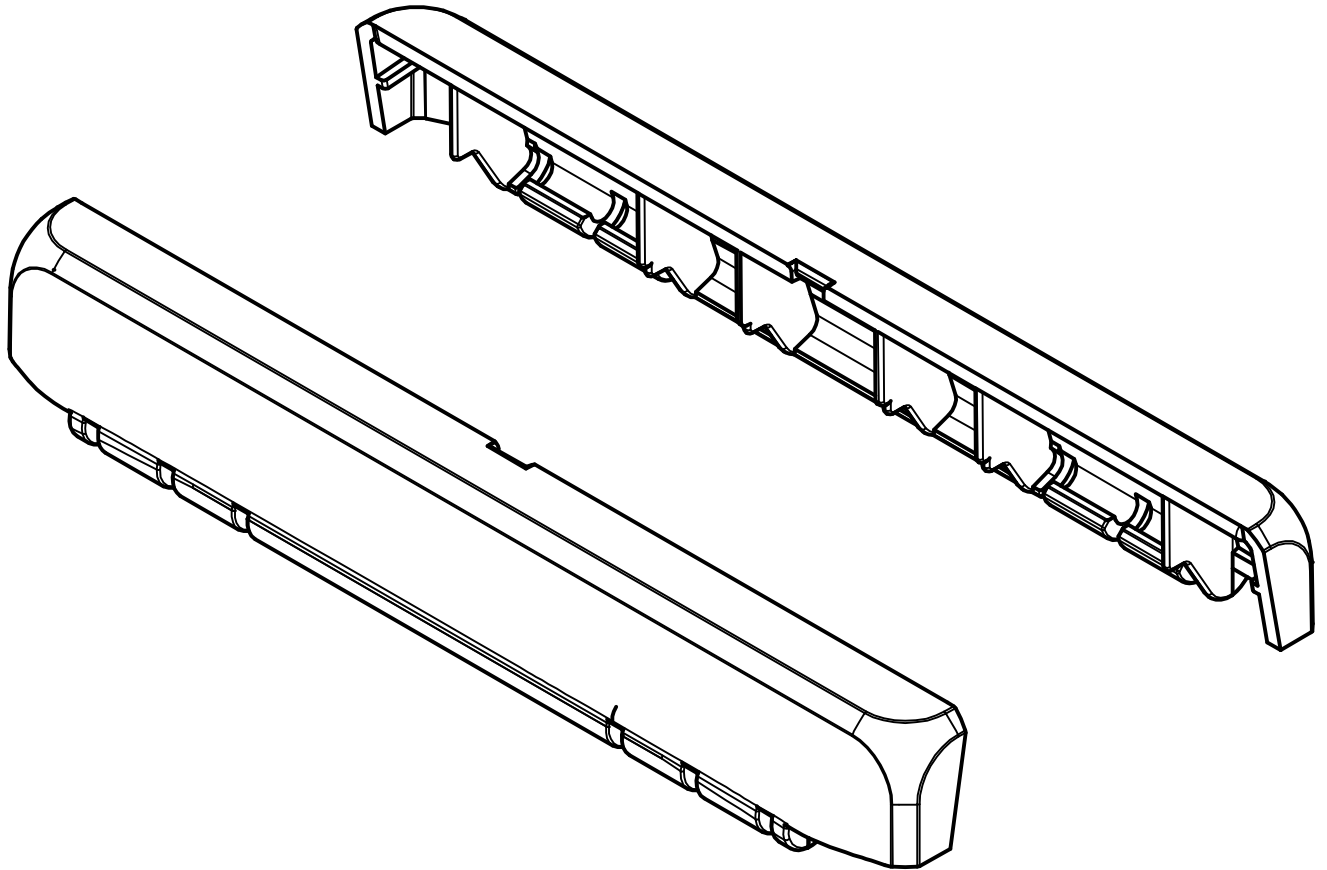

B SC 17 Montagerichtung  
B SC 17 mounting direction

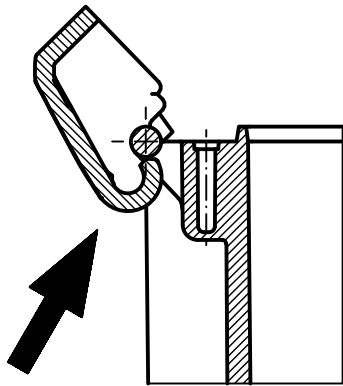

B SC 17 montiert  
B SC 17 mounted

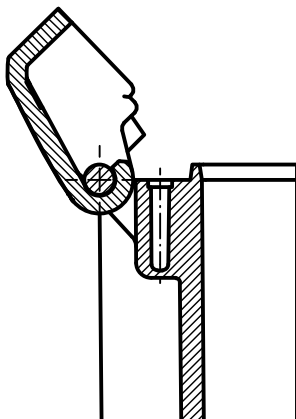

Maßstab/  
Scale: 1:1

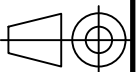

Zeichnungs-Nr. / Drawing-No.:  
4K 5390.043.01

Artikel / Article:  
BOCUBE  
B SC 17  
Katalogzg./Catalogue draw.

Ä.Nr/  
Alt.No:

Datum/  
Date:

DISK: 2503388.idw  
Datum/Date: 11.07.2012 KH



A Phoenix Mecano Company