

THIS IS A C.A.D. GENERATED DRAWING
DO NOT MAKE MANUAL REVISIONS TO MASTER.

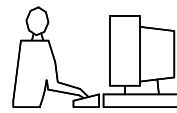

* UNLESS OTHERWISE SPECIFIED TOLERANCES
ON DECIMAL IS: ANGLE ±3°
UNIT: MM
X ±0.50
X.X ±0.38
X.XX ±0.25
X.XXX ±0.10

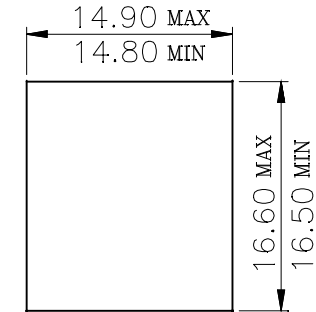
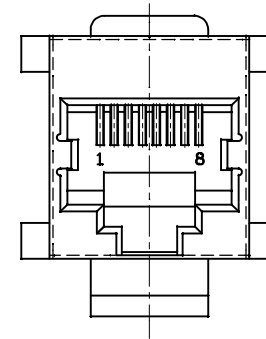
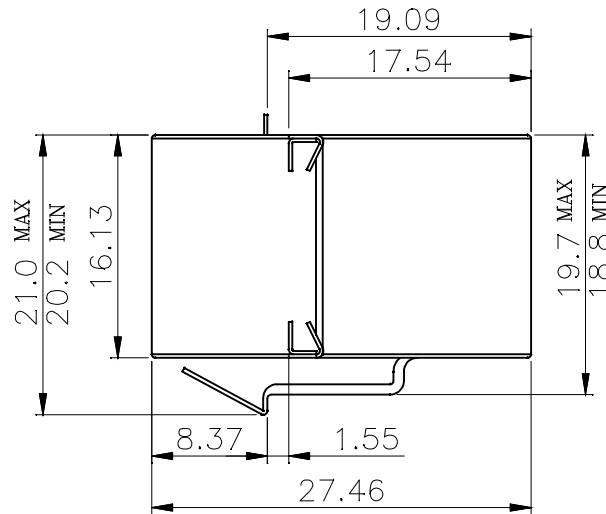
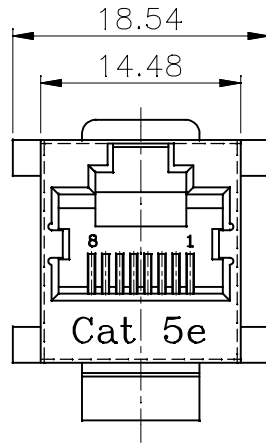

Front Panel Jack Only Clearance
W/O Latch Feature

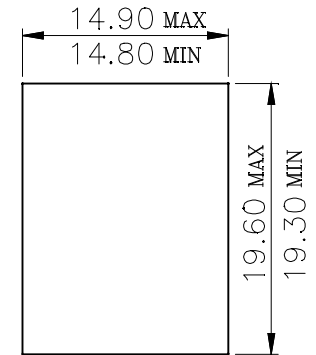
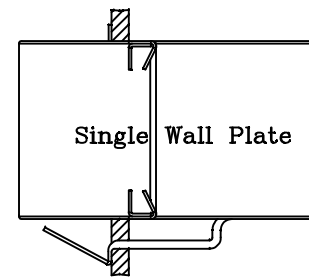
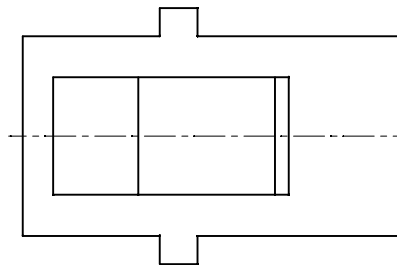
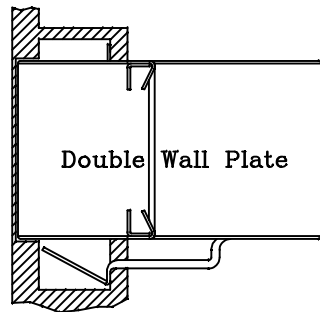

Single Panel-Latch Clearance
Panel Thickness 0.062 inch.

1. MATERIALS:

- 1.1 SHIELDED: STAINLESS STEEL.
- 1.2 PLASTIC HOUSING: ENGINEERING THERMOPLASTIC
FLAMMABILITY RATING UL 94V-0.
- 1.3 CONTACTS: 0.35MM THICKNESS PHOSPHOR BRONZE.
- 1.4 PLATING: GOLD PLATING OVER NICKEL IN CONTACT.

THESE DRAWINGS AND SPECIFICATIONS ARE THE PROPERTY OF MH CONNECTORS LTD. AND SHALL NOT BE REPRODUCED, COPIED OR USED AS THE BASIS FOR THE MANUFACTURE OR SALE OF APPARATUS WITHOUT WRITTEN PERMISSION.

DRAWN HALEY		DATE 11-13-13
APPROVED		DATE
SCALE	SHEET OF 1 OF 1	REV: 1.0
DRAWING No MH3101S-CAT5e		



THIS SERIES FULLY CONFORMS TO THE EUROPEAN UNION DIRECTIVES 2002/95/EC AND 2002/96/EC FOR RoHS COMPLIANCY.



MH CONNECTORS LTD.