

CKT NO	PART NO	DIM A
2	171692-0102	8.35
4	171692-0104	12.05
6	171692-0106	17.75
8	171692-0108	23.45 +0.40
10	171692-0110	29.15 +0.40
12	171692-0112	34.85 +0.40

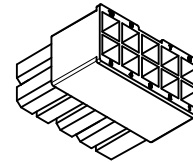

171692-0110

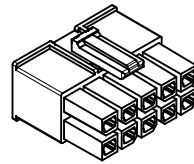
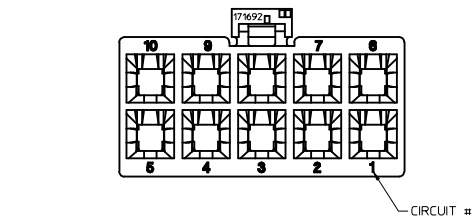
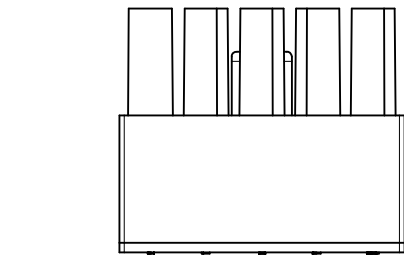
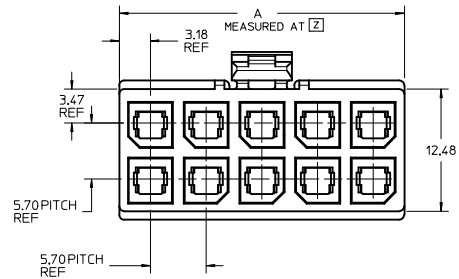
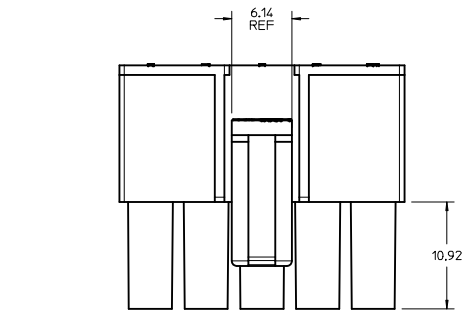
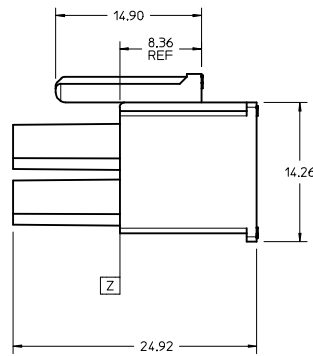

NOTES:

- MATERIAL:
HOUSING: PBT, UL 94V-0, COLOR: BLACK.
- FINISH: NOT APPLICABLE.
- PRODUCT SPECIFICATION: PS-76823-100.
- PACKAGING: BULK PACK PER PK-170001-001
- PART MATES WITH MOLEX SERIES NUMBERS 76825, 76829, 172064, AND 172065.
- PART IS FOR USE WITH MOLEX FEMALE TERMINAL 76823 OR 172063 SERIES.
- APPLICATION SPECIFICATION: AS-76823-100.
- PARTS CONFORM TO CLASS B REQUIREMENTS OF COSMETIC SPECIFICATION PS-45499-002 WITH THE EXCEPTION OF DISCOLORATION MEETS CLASS "C" REQUIREMENTS.

UPDATE NOTE 7 IEC NO: UCP2014-5278 DRAWN: DFOX 2014/06/17 CHKD: BELL 2014/06/17 APPR: F SMITH 2014/06/23	QUALITY SYMBOLS ▽=0 ▽=0 ▽=0	GENERAL TOLERANCES (UNLESS SPECIFIED) mm INCH 4 PLACES ±--- ±--- 3 PLACES ±--- ±--- 2 PLACES ±0.25 ±--- 1 PLACE ±--- ±--- 0 PLACE ±--- ±---	DIMENSION STYLE MM ONLY	SCALE 4:1	DESIGN UNITS METRIC	THIRD ANGLE PROJECTION
		DRAWN BY: MKARADIMAS CHECKED BY: A. PATEL APPROVED BY: APATEL	DATE: 2012/08/01 DATE: 2012/08/17	TITLE MEGA-FIT RECEPTACLE HOUSING 2-12 CKT	MATERIAL NO. SEE CHART	DOCUMENT NO. SD-171692-0100

20 19 18 17 16 15 14 13 12 11 10 9 8 7 6 5 4 3 2 1

2 CKTS

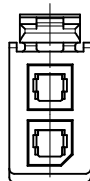

4 CKT

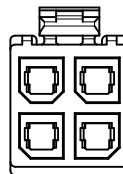

6 CKT

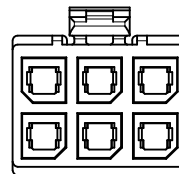

8 CKT

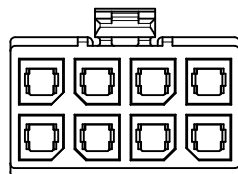

10 CKTS

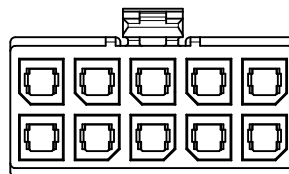

12 CKTS

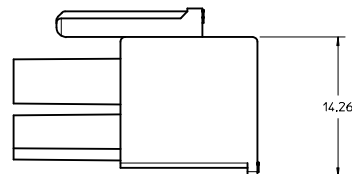
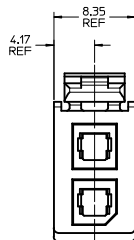
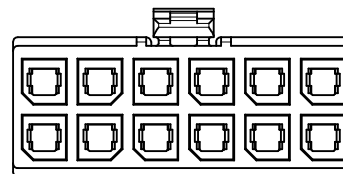

171692-0102

SEE SHT 1 IEC NO: UCIP2014-5278 DRAWN: JDFOX CHECKED: JRELL APPR: FSWITH 2014/06/17 2014/06/17 2014/06/17	QUALITY SYMBOLS ∇=0 ∇=0 ∇=0	GENERAL TOLERANCES (UNLESS SPECIFIED)		DIMENSION STYLE MM ONLY	SCALE 4:1	DESIGN UNITS METRIC	THIRD ANGLE PROJECTION
		4 PLACES ±--- ±--- 3 PLACES ±--- ±--- 2 PLACES ±0.25 ±--- 1 PLACE ±--- ±--- 0 PLACE ±--- ±---	mm INCH --- --- --- --- ---	DRAWN BY MKARADIMAS DATE 2012/08/01	CHECKED BY DATE ---	APPROVED BY APATEL DATE 2012/08/17	MATERIAL NO. SEE CHART
DRAFT WHERE APPLICABLE MUST REMAIN WITHIN DIMENSIONS		ANGULAR ±1/2°		THIS DRAWING CONTAINS INFORMATION THAT IS PROPRIETARY TO MOLEX INCORPORATED AND SHOULD NOT BE USED WITHOUT WRITTEN PERMISSION			

19 18 17 16 15 14 13 12 11 10 9 8 7 6 5 4 3 2 1