

12 CIRCUIT VERTICAL USCAR HEADER
POLARIZATION OPTION A

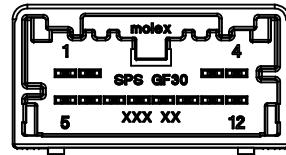

12 CIRCUIT VERTICAL USCAR HEADER
POLARIZATION OPTION B

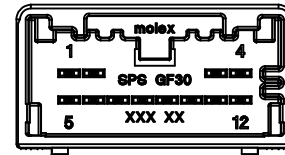

12 CIRCUIT VERTICAL USCAR HEADER
POLARIZATION OPTION C

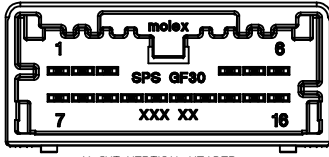

16 CKT VERTICAL HEADER
POLARIZATION OPTION A

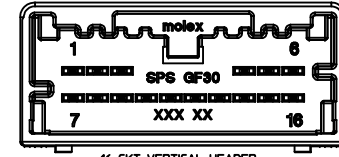

16 CKT VERTICAL HEADER
POLARIZATION OPTION B

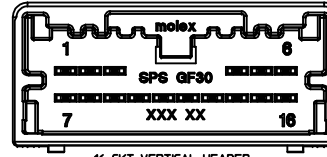

16 CKT VERTICAL HEADER
POLARIZATION OPTION C

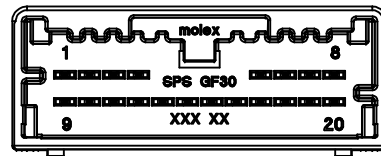

20 CKT VERTICAL HEADER
POLARIZATION OPTION A

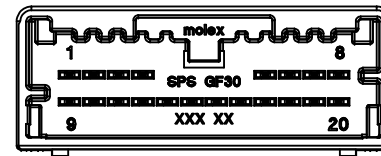

20 CKT VERTICAL HEADER
POLARIZATION OPTION B

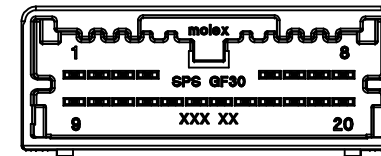

20 CKT VERTICAL HEADER
POLARIZATION OPTION C

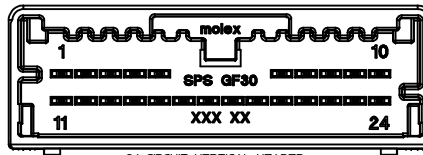

24 CIRCUIT VERTICAL HEADER
POLARIZATION OPTION A

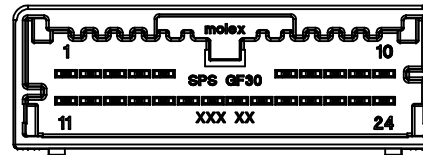

24 CIRCUIT VERTICAL HEADER
POLARIZATION OPTION B

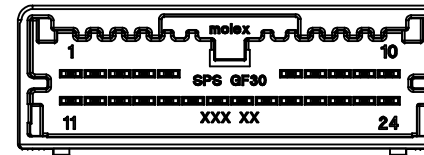

24 CIRCUIT VERTICAL HEADER
POLARIZATION OPTION C

NOTES: VALID UNLESS OTHERWISE SPECIFIED

1. GENERAL:
 - a. APPLICATION SPECIFICATION SEE: AS-34791-020
 - b. PRODUCT SPECIFICATION SEE: PS-34791-020
 - c. PACKAGING SPECIFICATION PER MOLEX DRAWING: SEE CHART
 - d. SOLDERABILITY PER SMES-152
 - e. PARTS MUST BE IN COMPLIANCE TO MOLEX CHEMICAL SUBSTANCES FOR PRODUCTS AND PACKAGING SPECIFICATION: QEHS-699000-300
 - f. DATA MUST BE SUBMITTED UNDER THE MOLEX PART NUMBER TO IMDS (COMPANY ID#13255)
 - g. FLAMMABILITY REQUIREMENT: PER ISO3795 OR GM3191
 - h. VISUAL DEFECTS SHALL MEET COSMETIC STANDARD PS-45499-002 (Class B)
2. DESIGN - MATERIALS:
 - a. SHROUD (PLASTIC HOUSING): SPS 30% GF, 20% REGRIND MAX PER WEIGHT
 - b. BLADES:
 - BASE METAL: C260 BRASS
 - PLATING REQUIREMENTS:
 - TIN OVER NICKEL:
 - UNDERPLATING:
 - OVERALL NICKEL
 - OVERPLATING:
 - OVERALL TIN
3. DESIGN - GEOMETRY:
 - a. THIS IS A 100% CAD GENERATED PART. THE CAD MATHEMATICAL DATA IS THE MASTER FOR THIS PART. FOR DIMENSIONAL OR ANY INFORMATION NOT SHOWN ON THIS DRAWING, ANALYZE THE CAD MODEL.
 - b. GEOMETRIC DIMENSIONS AND TOLERANCES PER ASME Y14.5M - 2009
 - c. GENERAL TOLERANCES: SEE TITLE BLOCK
 - d. EDGES AND UNDIMENSIONED DETAILS PER ISO13715
 - e. CORNERS SHOWN AS SHARP TO BE R 0.1 MAX
 - f. LETTERING SHALL BE 0.10 MAX RAISED. THIS INCLUDES RECYCLING CODE, PLANT AND CAVITY ID, VENDOR ID, AND CIRCUIT ID.

LAST BALLOON ON DRAWING:
⑩
DELETED BALLOONS:
① ② ③ ④ ⑤ ⑥

DARK GRAY POL C EC NO: UAU2015-0610 DRAWN: TMACHUGA 2014/10/20 CHKD: APPROVED: MAN 2014/10/20 APPR: RBALMAN	QUALITY SYMBOLS	GENERAL TOLERANCES (UNLESS SPECIFIED)	DIMENSION STYLE	SCALE	DESIGN UNITS	THIRD ANGLE PROJECTION
	∇=0 ∇=0 ∇=0	4 PLACES ±.005 3 PLACES ±.010 2 PLACES ±.020 1 PLACE ±.050 0 PLACE ±.150	mm INCH ANGULAR ± 3 ° DRAFT WHERE APPLICABLE MUST REMAIN WITHIN DIMENSIONS	MM ONLY DRAWN BY: TCUCU CHECKED BY: TMACHUGA APPROVED BY: SMARCEAU DATE: 2011/02/25 DATE: 2011/02/28 DATE: 2012/05/03	5:1	METRIC
		THIS DRAWING CONTAINS INFORMATION THAT IS PROPRIETARY TO MOLEX INCORPORATED AND SHOULD NOT BE USED WITHOUT WRITTEN PERMISSION				SHEET NO. 1 OF 4

20 19 18 17 16 15 14 13 12 11 10 9 8 7 6 5 4 3 2 1

12 CIRCUIT VERTICAL
USCAR HEADER

16 CKT VERTICAL HEADER

20 CKT VERTICAL HEADER

24 CIRCUIT VERTICAL HEADER

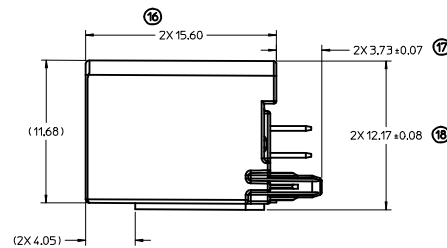
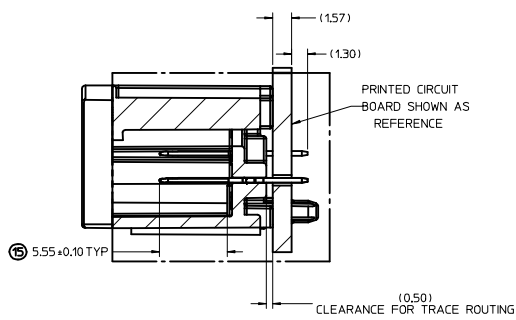
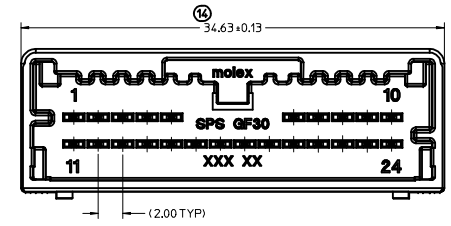
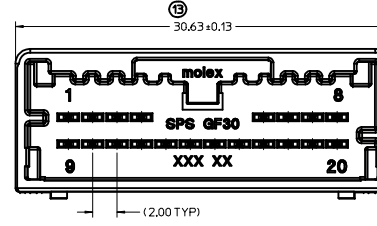
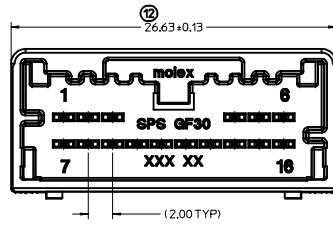
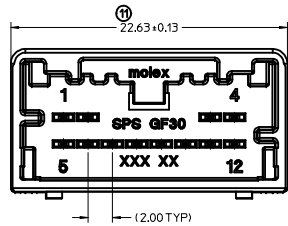
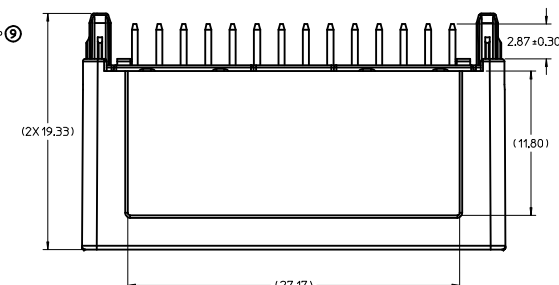
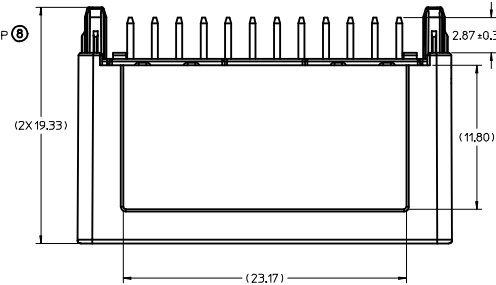
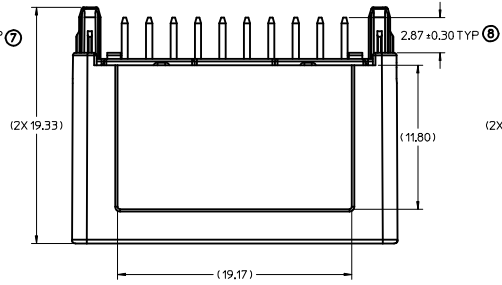
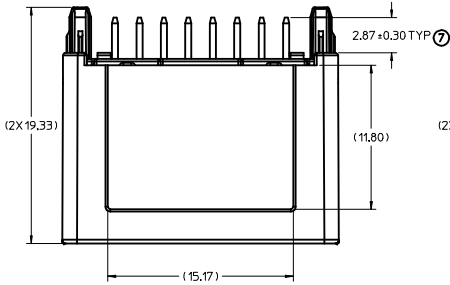

DARK GRAY POL C EC NO: UAU2015-0610 CHKO: TMACHUGA 2014/10/20 APPROVAL: APPR:BAUMAN 2014/10/20	QUALITY SYMBOLS	GENERAL TOLERANCES (UNLESS SPECIFIED)	DIMENSION STYLE	SCALE	DESIGN UNITS	THIRD ANGLE PROJECTION
	▽=0	4 PLACES ± mm	MM ONLY	5:1	METRIC	
	▽=0	3 PLACES ± INCH				
	▽=0	0 PLACE ±				
		ANGULAR ± 3 °				
		DRAFT WHERE APPLICABLE MUST REMAIN WITHIN DIMENSIONS				
			MATERIAL NO.	DOCUMENT NO.		
			SEE CHART	SD-34825-001		
						SHEET NO. 2 OF 4

19 18 17 16 15 14 13 12 11 10 9 8 7 6 5 4 3 2 1

12 CKT VERTICAL HEADER
PCB CONFIGURATION

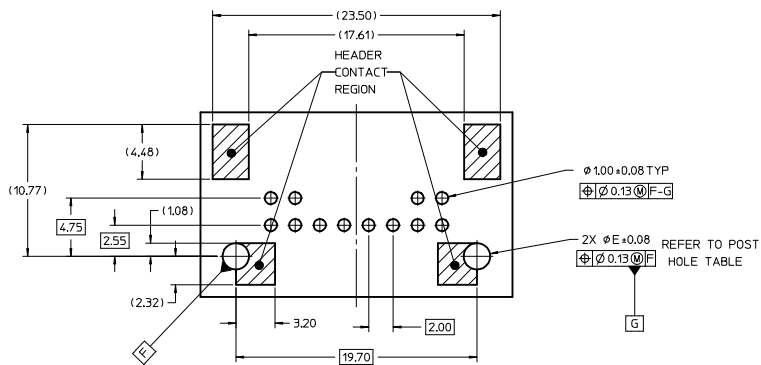

16 CKT VERTICAL HEADER
PCB CONFIGURATION

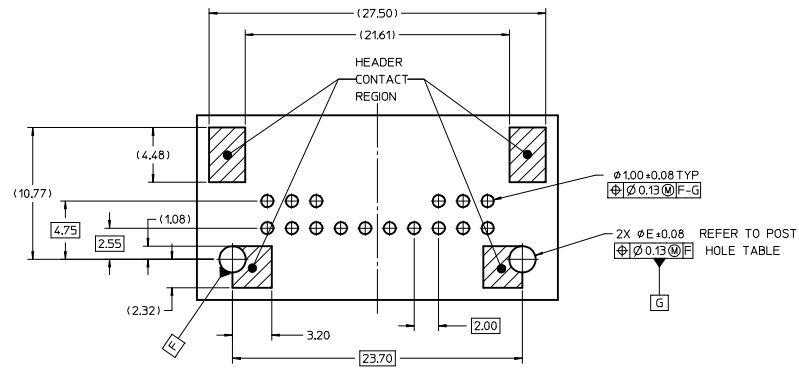

20 CKT VERTICAL HEADER
PCB CONFIGURATION

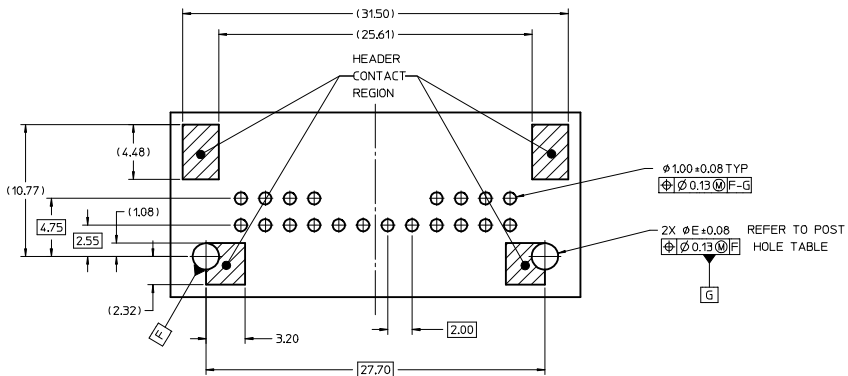

24 CKT VERTICAL HEADER
PCB CONFIGURATION

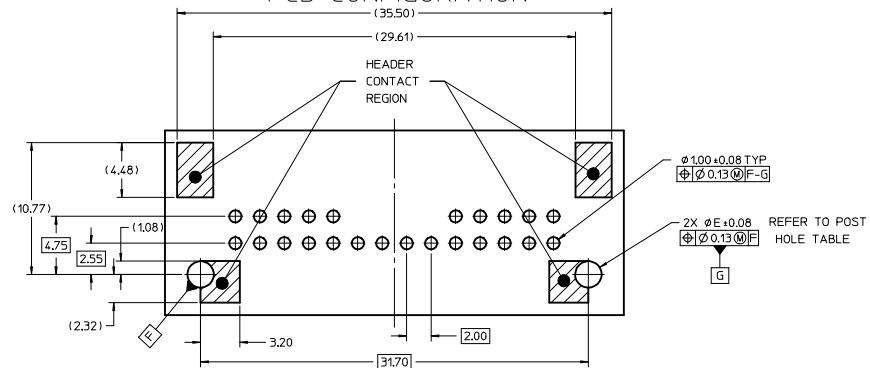

POST HOLE TABLE

	DIM 'E'
PRESS FIT	2.15
DROP IN	2.55

DARK GRAY POL C EC NO: UAU2015-0610 DRAWN: TMACHUGA 2014/10/20 CHKD: APPR: RBALMAN 2014/10/20	QUALITY SYMBOLS	GENERAL TOLERANCES (UNLESS SPECIFIED)	DIMENSION STYLE	SCALE	DESIGN UNITS	THIRD ANGLE PROJECTION
	▽=0	mm INCH	MM ONLY	5:1	METRIC	☉
	▽=0	4 PLACES ± --- ± ---	DRAWN BY	DATE	TITLE	
	▽=0	3 PLACES ± 0.10 ± ---	TCUCU	2011/02/25	MINI 50 DUAL ROW VERTICAL ASSEMBLY SALES DRAWING	
		2 PLACES ± 0.20 ± ---	CHECKED BY	DATE		
		1 PLACE ± --- ± ---	TMACHUGA	2011/02/28		
		0 PLACE ± --- ± ---	APPROVED BY	DATE		
			SMARCEAU	2012/05/03		
		ANGULAR ± 3 °	MATERIAL NO.	DOCUMENT NO.		
		DRAFT WHERE APPLICABLE MUST REMAIN WITHIN DIMENSIONS	SEE CHART	SD-34825-001		
			SIZE D	THIS DRAWING CONTAINS INFORMATION THAT IS PROPRIETARY TO MOLEX INCORPORATED AND SHOULD NOT BE USED WITHOUT WRITTEN PERMISSION		
						SHEET NO. 3 OF 4

20 19 18 17 16 15 14 13 12 11 10 9 8 7 6 5 4 3 2 1

MINI 50 VERTICAL HEADER ASSEMBLIES

MATERIAL NUMBER TUBE PACKAGING PK-31301-688	MATERIAL NUMBER TRAY PACKAGING PK-31301-440	CONFIGURATION	CIRCUIT	POL	COLOR	BLADE PLATING	MATING COMPONENT	
							UN-BRIDGED	BRIDGED
34825-9124	34825-0124	USCAR	12	A	BLACK	TIN OVER NICKEL	34824-0124	34824-1124
34825-9125	34825-0125	USCAR	12	B	GRAY	TIN OVER NICKEL	34824-0125	34824-1125
34825-9126	34825-0126	USCAR	12	C	DARK GRAY	TIN OVER NICKEL	34824-0126	34824-1126
34825-9160	34825-0160	MOLEX	16	A	BLACK	TIN OVER NICKEL	34824-0160	34824-1160
34825-9161	34825-0161	MOLEX	16	B	GRAY	TIN OVER NICKEL	34824-0161	34824-1161
34825-9162	34825-0162	MOLEX	16	C	DARK GRAY	TIN OVER NICKEL	34824-0162	34824-1162
34825-9200	34825-0200	MOLEX	20	A	BLACK	TIN OVER NICKEL	34824-0200	34824-1200
34825-9201	34825-0201	MOLEX	20	B	GRAY	TIN OVER NICKEL	34824-0201	34824-1201
34825-9202	34825-0202	MOLEX	20	C	DARK GRAY	TIN OVER NICKEL	34824-0202	34824-1202
34825-9240	34825-0240	MOLEX	24	A	BLACK	TIN OVER NICKEL	34824-0240	34824-1240
34825-9241	34825-0241	MOLEX	24	B	GREY	TIN OVER NICKEL	34824-0241	34824-1241
34825-9242	34825-0242	MOLEX	24	C	DARK GRAY	TIN OVER NICKEL	34824-0242	34824-1242

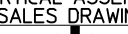
DARK GRAY POL C DEC NO: JAU2015-0610 DRAWN: TMACHUGA 2014/10/20 CHYK: APPR: BRALMAN 2014/10/20 REV:	QUALITY SYMBOLS ▽=0 ▽=0 ▽=0	GENERAL TOLERANCES (UNLESS SPECIFIED) mm INCH 4 PLACES ± --- ± --- 3 PLACES ± --- ± --- 2 PLACES ± 0.10 ± --- 1 PLACE ± 0.20 ± --- 0 PLACE ± ±	DIMENSION STYLE MM ONLY	SCALE 5:1	DESIGN UNITS METRIC	THIRD ANGLE PROJECTION	
	DRAFT WHERE APPLICABLE MUST REMAIN WITHIN DIMENSIONS	DRAWN BY TCUCU CHECKED BY TMACHUGA APPROVED BY SMARCEAU	DATE 2011/02/25 2011/02/28 2012/05/03	TITLE MINI 50 DUAL ROW VERTICAL ASSEMBLY SALES DRAWING 			
	MATERIAL NO. SEE CHART	DOCUMENT NO. SD-34825-001	SHEET NO. 4 OF 4	THIS DRAWING CONTAINS INFORMATION THAT IS PROPRIETARY TO MOLEX INCORPORATED AND SHOULD NOT BE USED WITHOUT WRITTEN PERMISSION			