

Sentinel® Connector Systems Inc.

1953 Stanton Street

York, Pa. 17404

PART NO.: 110-101010-24

* THIS PRODUCT USES NO PARTITIONS BETWEEN CONDUCTOR SLOTS *

- * TEN CONDUCTOR MODULAR PLUG
- * RADIUSSED OPENING FOR ROUND CABLE
- * FOR CONDUCTORS WITH MAXIMUM O.D. OF .040
- * FOR SOLID OR STRANDED WIRE APPLICATIONS
- * USES .014 THICK CONTACT

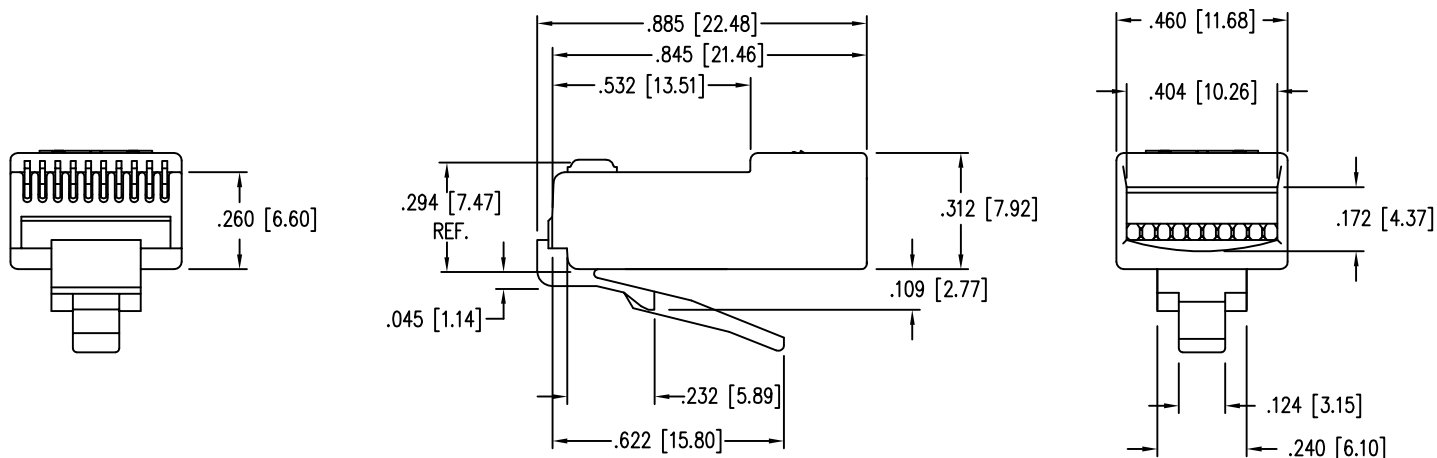
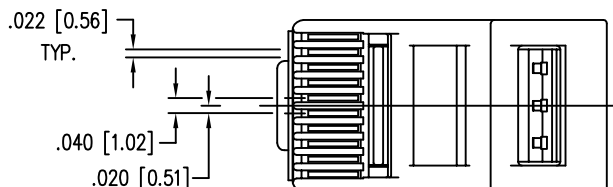

SPECIFICATIONS :

PERFORMANCE:	MEETS OR EXCEEDS CATEGORY 5e TIA/EIA 568-B.2
CONTACT MATERIAL:	PHOSPHOR BRONZE - .014 THK
CONTACT PLATING:	50 MICRO-INCH SELECTIVE GOLD PLATE IN CONTACT AREA OVER 100 MICRO-INCH MINIMUM NICKEL PLATING. OTHER PLATING THICKNESSES AVAILABLE.
PLUG MATERIAL:	POLYCARBONATE
PLUG TOLERANCES AND DIMENSIONS:	* COMPLIES WITH ANSI/TIA-1096-A REQUIREMENTS
U.L. RECOGNIZED	File# E188111
FLAME AUTO EXTINGUISH	94-V0
OPERATION TEMPERATURE:	-40°C TO +85°C
INSERTION/EXTRACTION LIFE:	1000 CYCLES
CONTACT RESISTANCE:	10 MILLOHMS MAX.
CURRENT/VOLTAGE:	30 VAC/42 VDC AT 1.5 AMPS
(RoHS COMPLIANT)	

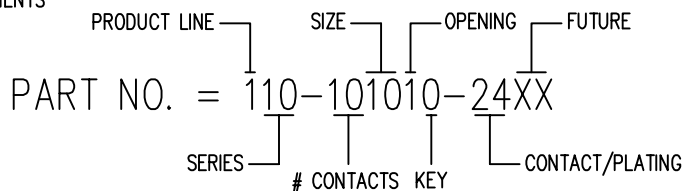

* FORMER COMPLIANCE, FCC PART 68.500