

THIS DRAWING IS UNPUBLISHED. RELEASED FOR PUBLICATION

© COPYRIGHT - By Tyco Electronics Japan G.K.

ALL RIGHTS RESERVED.

LOC	DIST	REVISIONS			DATE	DWN	APVD
P	LTR	DESCRIPTION					
	F	REVISED		27SEP2013	H.U	N.Y	

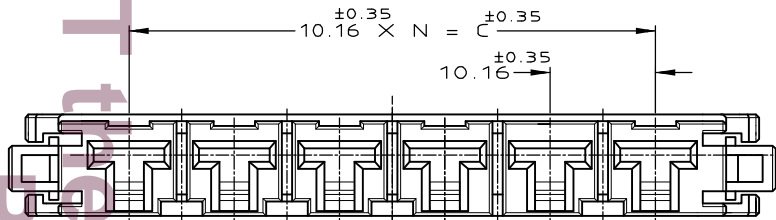
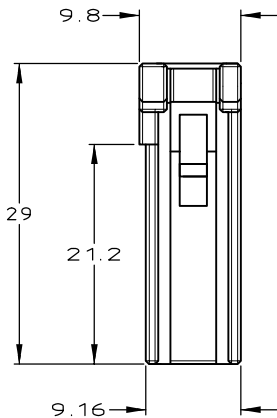
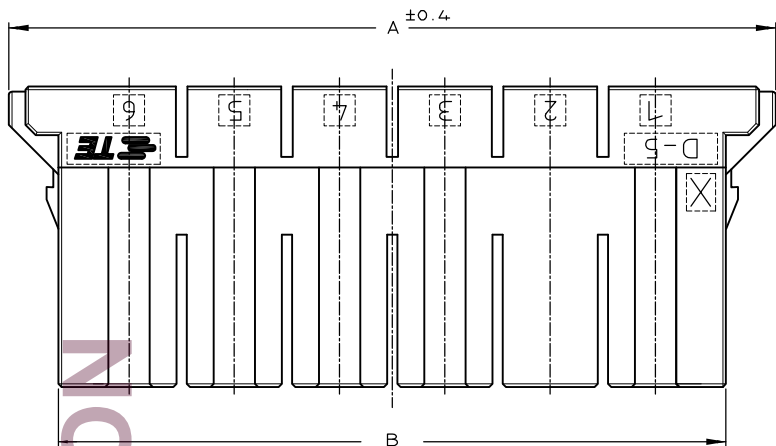
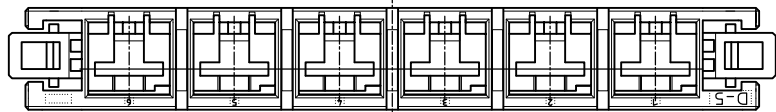

1-179958-6  
(KEYING CODE:X)

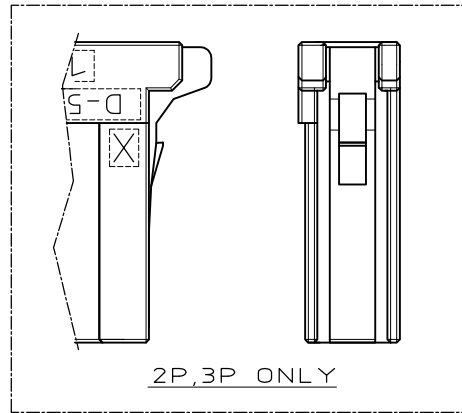
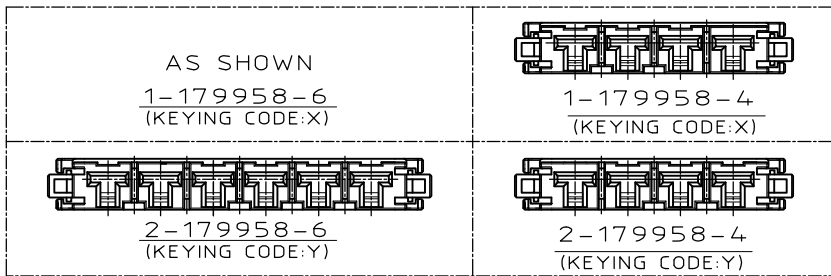

注記

- ① 材料: ハウジング: ガラス入り熱可塑性  
ポリエステル樹脂(94V-0),色: 黒
- ② ハウジング全面にテフロン塗装のこと
- ③ 製品規格 :108-5453

NOTES

- ① MATERIAL:HOUSING:GLASS FILED THERMO PLASTIC ,POLYESTER(94V-0),COLOR:BLACK
- ② TO COAT ALL SURFACE OF HOUSING WITH TEFLON
- ③ PRODUCT SPEC :108-5453

FINISH	C	B	A	N	POS	COLOR	P/N
						BLACK	2-179958-6
		50.8	64.4	74	5	6	BLACK 1-179958-6
OBSOLETE	△						<del>5-179958-4</del>
						BLACK	2-179958-4
		30.48	44.08	53.68	3	4	BLACK 1-179958-4
OBSOLETE	△						<del>5-179958-3</del>
						NATURAL	9-179958-3
						BLACK	2-179958-3
		20.32	33.92	45.92	2	3	BLACK 1-179958-3
						BLACK	2-179958-2
		10.16	23.76	35.76	1	2	BLACK 1-179958-2

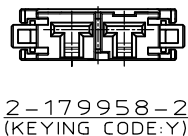
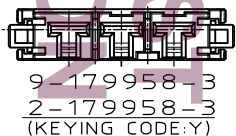
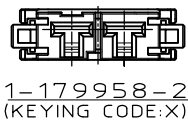
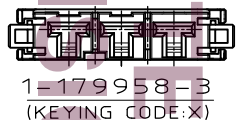

THIS DRAWING IS A CONTROLLED DOCUMENT.

DIMENSIONS: mm

TOLERANCES UNLESS OTHERWISE SPECIFIED:

0 PLC ± 0.2  
1 PLC ± 0.25  
2 PLC ± 0.3  
3 PLC ± 0.3  
4 PLC ± 0.3  
ANGLES ± 3'

MATERIAL: △

FINISH

APVD: S.MARABE

APPLICATION SPEC

WEIGHT

CUSTOMER DRAWING

DWN: Y.ISHIKAWA 22MAR1995  
CHK: S.MANABE 23MAR1995  
APVD: S.MARABE 23MAR1995

TE Connectivity

NAME: SINGLE ROW REC HSG DYNAMIC D-5200

SIZE: A3 CAGE CODE: 00779 DRAWING NO: C-179958 RESTRICTED TO: -

SCALE: 2:1 SHEET: 1 OF 1 REV: F