

Steckseite
Rear Mating

Anschlußseite
Front Mating

A

A

B

B

C

C

D

D

E

E

F

F

Messer-Typ
male pin type

A
B
C
ohne Übergabezone
without mating area

K
L
M
mit Übergabezone
with mating area

N
P
Q
mit Übergabezone
with mating area

R
S
T
mit Übergabezone
with mating area

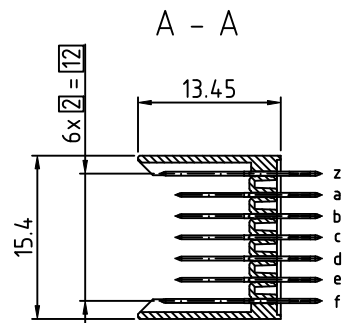
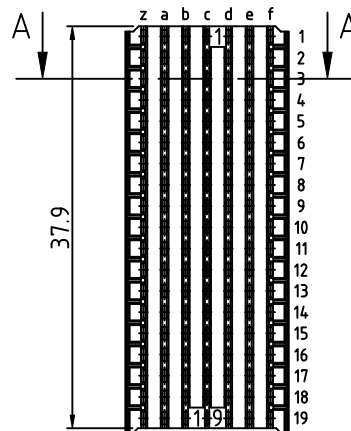
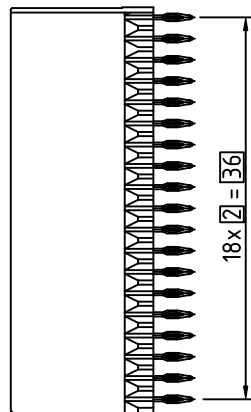
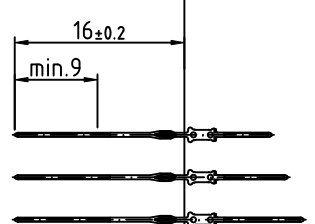
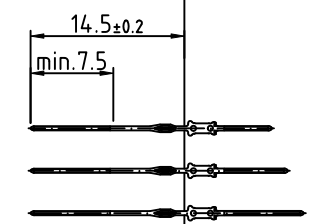
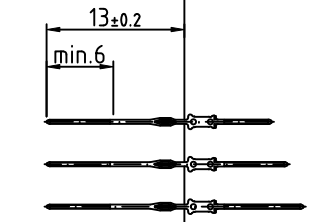
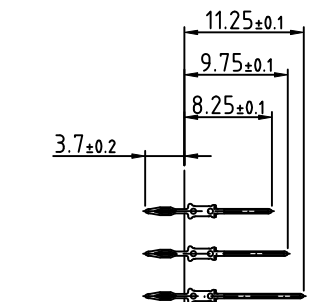

Leiterplatten-Lochbild
pcb-layout

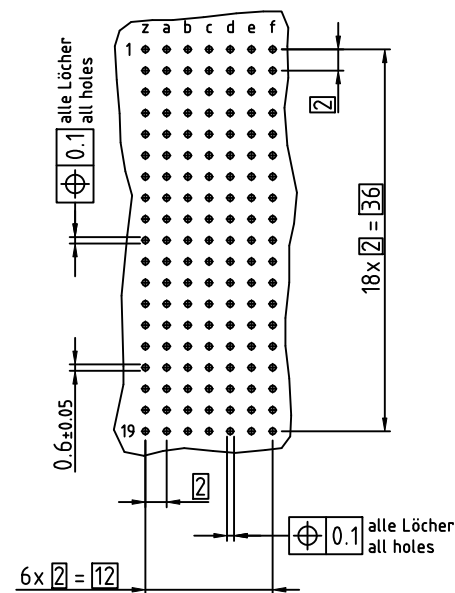

Bestückschaubild
Pin arrangement

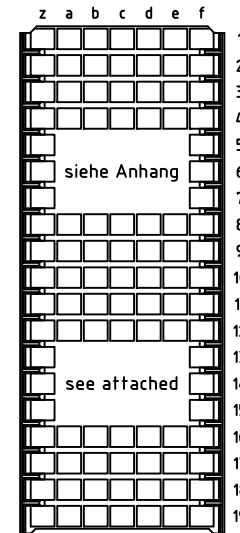

Technische Änderungen vorbehalten /
all data subject to amendment without notice

LP-Dicke / pcb-thickness:
Geeignet für LP-Dicke / fits for pcb-thickness: > 2.2

(für LP-Dicke / for pcb-thickness: 1.4 - 2.2
ept P/N: 243-XXXX- 05)

Mechanische Lebensdauer / performance level:
class 2, according to IEC 61076-4-101

Werkstoff / Material:				Allgemeintoleranz / General tolerances		Maßstab / Scale: 2:1	
				Fundamental tolerancing principle DIN ISO 8015		Verwendungsbereich / Range of application	
				A3		Kundenzzeichnung / customer drawing	
				Datum / Date		Benennung / Description	
				17.08.1999		hm 2.0 Messerleiste/male connector Type B19	
				Name / Name		Tcom press	
				HABIGER		Zeichnungsnummer / Drawing number	
				Gepr./Insp.		243-23XXX-15	
03 drawing modified 31.03.2010 Kowat.				ept GmbH		Art / Art Blatt / Sheet	
02 Zng. überarbeitet 30.07.2009 Mil.				www.ept.de		1	
01 ZNG. überarbeitet 08.11.1999 Hab.						Status/Status	
Version/Version Änderung / Revision Datum/Date Name/Name							

© Weitergabe sowie Vervielfältigung dieses Dokuments, Verwertung und Mitteilung seines Inhalts sind
ohne die ausdrückliche Genehmigung des Erfinders oder seiner Erben ausdrücklich untersagt.
Alle Rechte für den Fall der Patent-, Gebrauchsmuster- oder Geschmacksmustereintragung vorbehalten.



Bestückungsplan / Pin arrangement **243-23320-15**

Type : **B-19**

(dimensions see drawing 243-23XXX-15)

	z	a	b	c	d	e	f
1	C	B	B	B	B	B	C
2	C	B	B	B	B	B	C
3	C	B	B	B	B	B	C
4	C	B	B	B	B	B	C
5	C	B	B	B	B	B	C
6	C	B	B	B	B	B	C
7	C	B	B	B	B	B	C
8	C	B	B	B	B	B	C
9	C	B	B	B	B	B	C
10	C	B	B	B	B	B	C
11	C	B	B	B	B	B	C
12	C	B	B	B	B	B	C
13	C	B	B	B	B	B	C
14	C	B	B	B	B	B	C
15	C	B	B	B	B	B	C
16	C	B	B	B	B	B	C
17	C	B	B	B	B	B	C
18	C	B	B	B	B	B	C
19	C	B	B	B	B	B	C

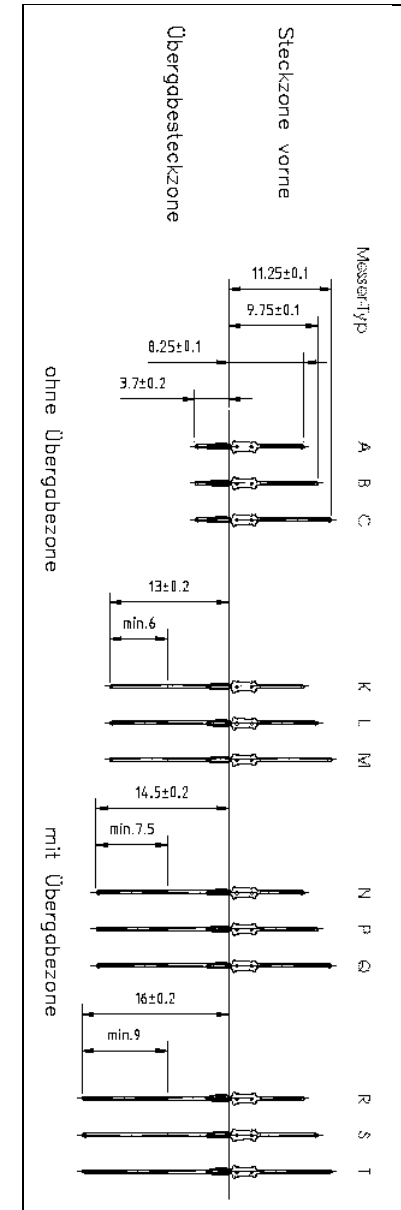

Erstellt: 01.01.1998