

REV.	LOCAS.	DESCRIPTION	DATE	DRAWN
01	NEW	INITIAL RELEASE.	2013.10.29	劉宗良
02	△	According to the actual requirement to update the latest specification	2014.10.08	楊濤

Specifications
 Current Rating:0.8Amp
 Insulation Resistance:1000MΩ Min.
 Dielectric Withstanding Voltage:500VAC
 Contact Resistance:35mΩ Max.
 Operating Temperature:-55°C to +125°C
 Materials
 Contact Material:Phosphor Bronze△
 Insulator Material:High Temperature Thermoplastic, UL 94V-0 LCP or the equivalent material
 Colour:Black
 All materials must meet Greenconn hazardous substances control standards.△

PIN NO.	A	B	C	D	E
2*06	6.35	10.77	13.20	9.37	8.37
2*13	15.24	19.66	22.09	18.26	17.26
2*25	30.48	34.90	37.33	33.50	32.50

Recommended P.C.Board Layout
 (Tolerance:±0.05)

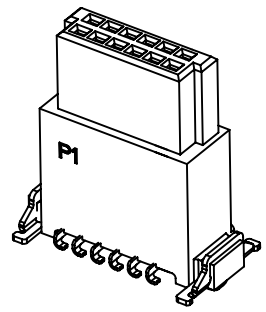
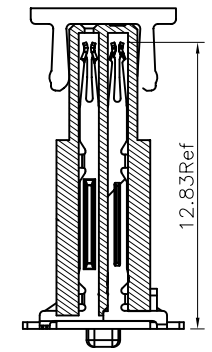
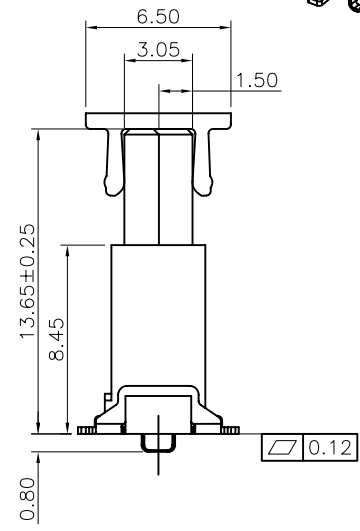
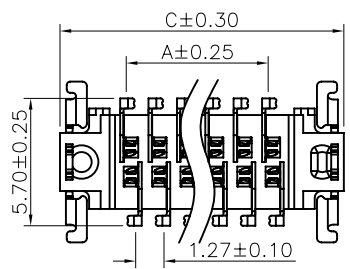
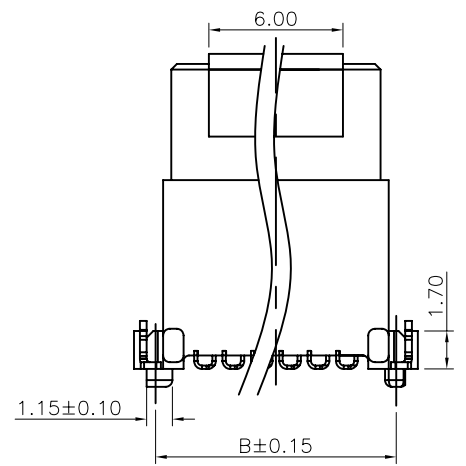
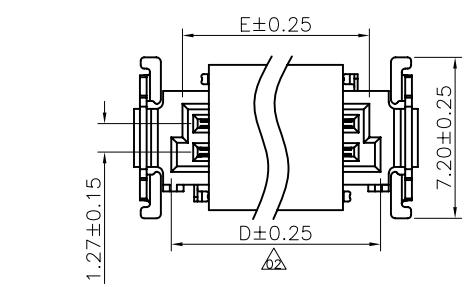
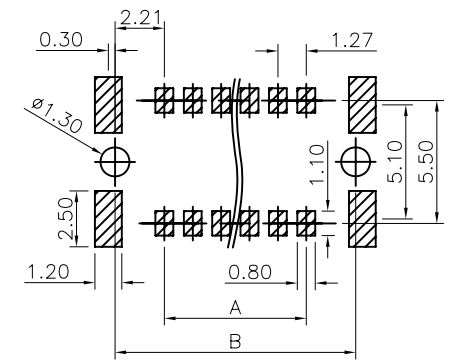

Ordering Information

CBEC220 - XX XX B001 C 1 A X

- No. of Pins per Row 06~25
- Standard Plating 79=5u"Au/80~160u"Matte Tin
- Selective Plating 34=10u"Gold/Gold Flash
- 05=Gold Flash/Tin
- Standard Packing C=tube
- E=cap+tube
- Selective Packing F=cap+tape&reel

格稜股份有限公司
Greenconn Corporation

GENERAL TOLERANCE	
X.±5.0°	X.±0.30
.X'±3.0°	.X±0.25
.XX'±2.0°	.XX±0.15
.XXX'±1.0°	.XXX±0.10

DESIGN: 楊濤	DATE: 2014.10.08
CHECKED: 林澤云	DATE: 2014.10.08
CO SIGNED: 徐軍博	DATE: 2014.10.08
APPROVED: Link	DATE: 2014.10.08

DWG. NO.	CBEC220-CB1CA
PART NO.	CBEC220-XX XX B001C1AX

TITLE:
 Pitch1.27 Female Connector
 SMC Type-B SMT Type
 High 13.65mm 180°

REV.	UNIT.	SCALE.	PAGE.
02	mm	1:1	1/1