

This drawing is copyright. Information contained thereon is supplied in confidence and must not be used for any other purpose than which it was supplied, or be reproduced without written permission of the owners.

type : 11 BNC-50-2-1

	date	sign
drawn	21.09.99	4726/Bom
checked	22.9.99	4727/H.S.
approved	22.9.99	4727/H.S.

cable shortening dimension

scale 2 : 1

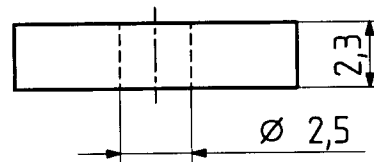
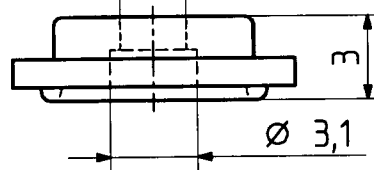
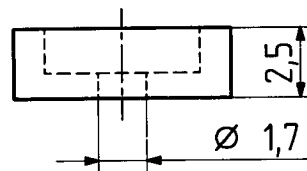
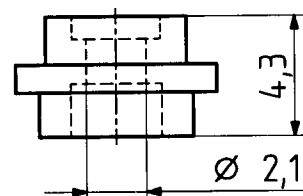
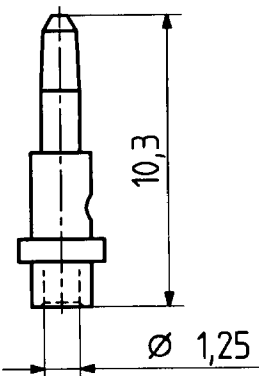
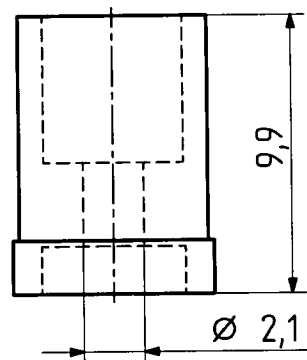
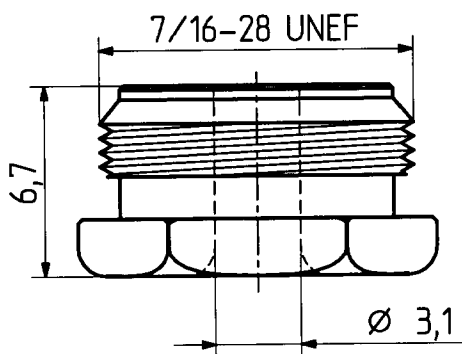
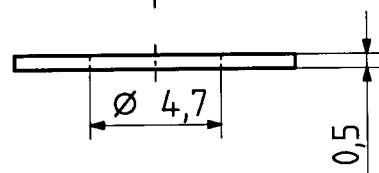
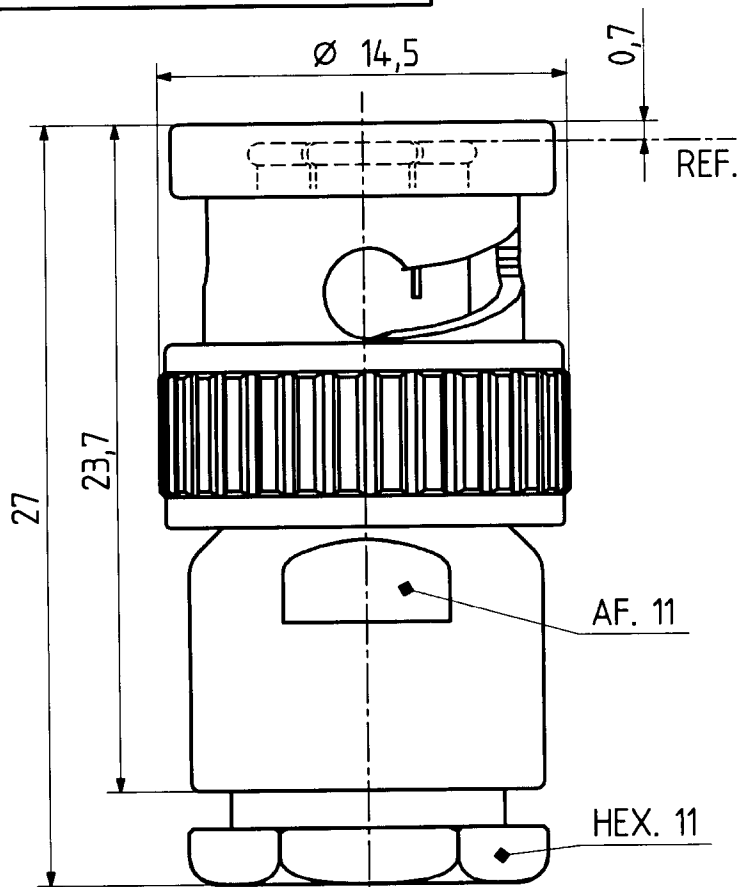
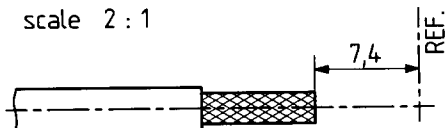

Diese Zeichnung ist unser geistiges Eigentum und darf ohne unsere ausdrückliche Einwilligung weder kopiert, vervielfältigt, noch Dritten oder Konkurrenzfirmen zugänglich gemacht werden.

H+S 701 4.4.8.05

scale

4 : 1



HUBER + SUHNER RFX

dimensions in mm

drawing number

4.13.32338

OZ drawing :

Index

a