

RECOMMENDED LAND PATTERN DIMENSION OF PCB (MOUNTING SIDE)  
 (RECOMMENDED METAL MASK THICKNESS:0.2mm)

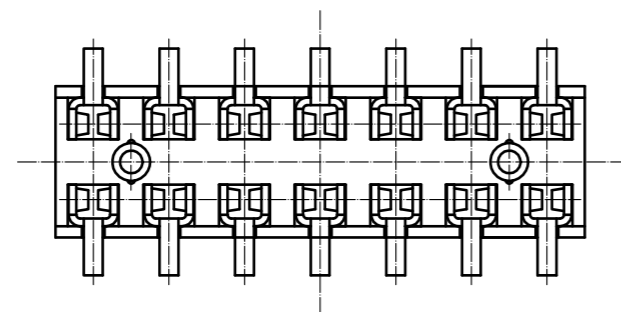
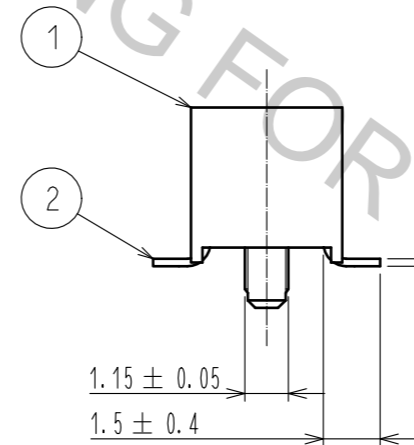
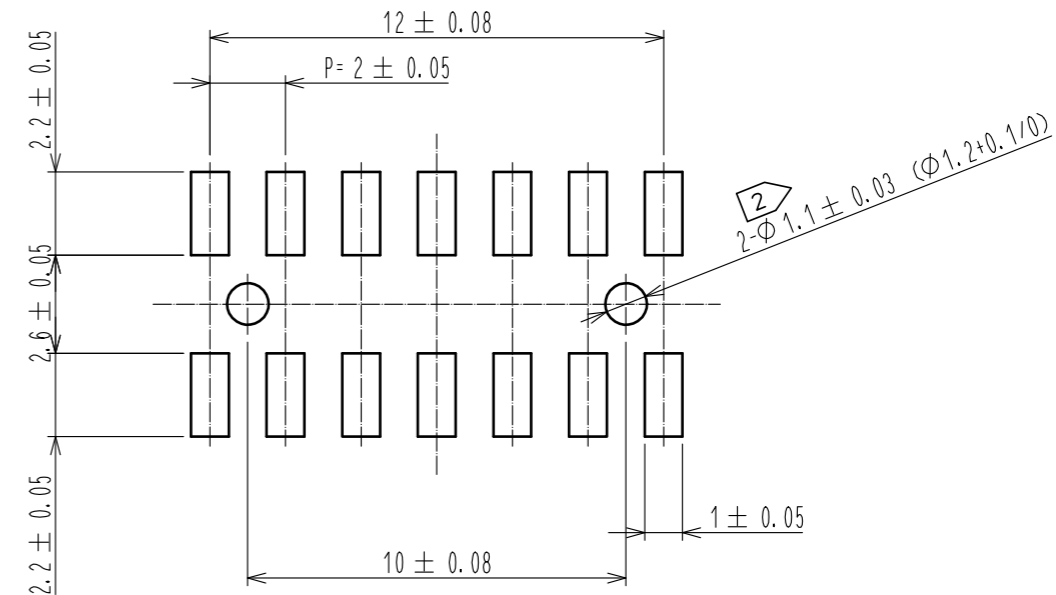
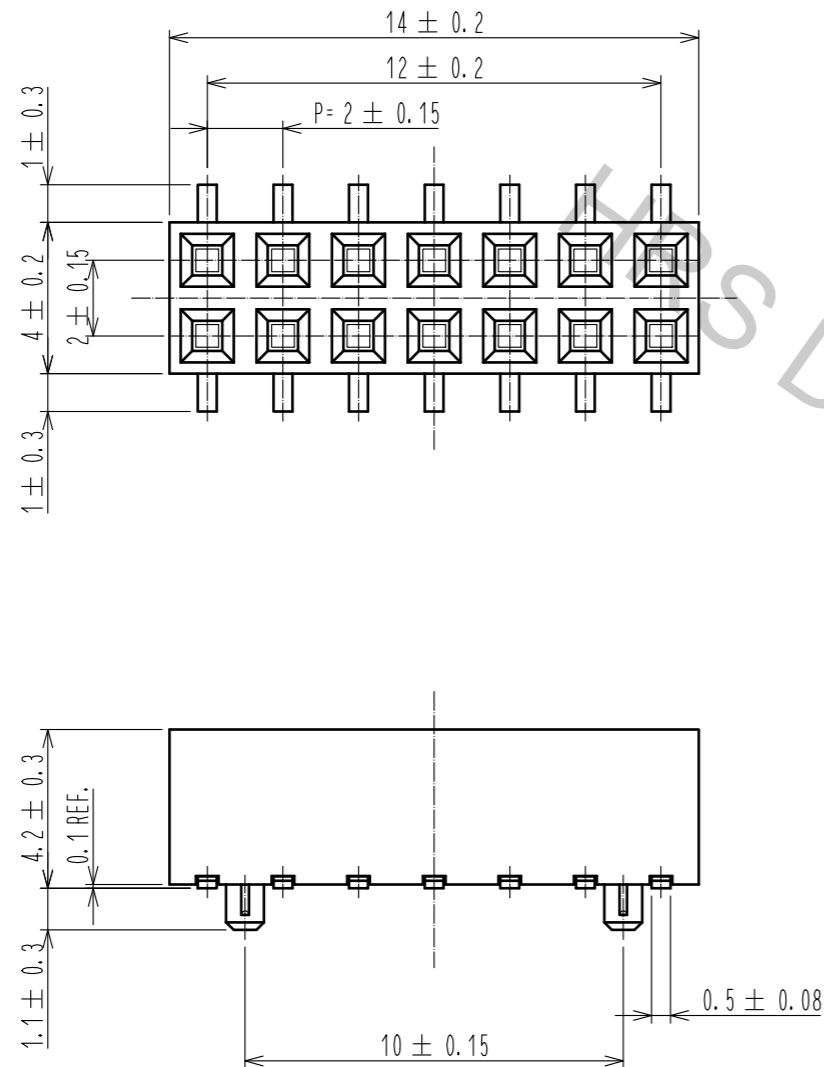

NOTES 1. LEAD CO-PLANARITY SHALL BE 0.15 MAX.  
 2. FOR AUTOMATED MOUNTING, RECOMMENDED THROUGH HOLE DIAMETER OF BOSS IS 1.2+0.1/0.

1	POLYPHENYLENE SULFIDE	LIGHT BROWN, UL94V-0	2	PHOSPHOR BRONZE	CONTACT: GOLD PLATING 0.2μm MIN LEAD : TIN REFLOW PLATING 1μm MIN UNDER : NICKEL PLATING 1μm MIN			
NO.	MATERIAL	FINISH . REMARKS	NO.	MATERIAL	FINISH . REMARKS			
UNITS	mm	SCALE	5:1	COUNT	DESCRIPTION OF REVISIONS	DESIGNED	CHECKED	DATE
<b>HRS</b> HIROSE ELECTRIC CO., LTD.		APPROVED : HS. OKAWA	15.07.16	DRAWING NO. EDC-082678-71-21				
		CHECKED : HT. YAMAGUCHI	15.07.16	PART NO. A3A-14DA-2SV(71)				
		DESIGNED : MT. ITANO	15.07.16	CODE NO. CL621-1145-9-71				
		DRAWN : MT. ITANO	15.07.16					