

Approximate Performance in Laboratory Tests

Tensile Strength: 3900 N  
Direct Torque: 1 Nm  
Body Torque: 0.4 Nm  
Shear Strength: 900 N

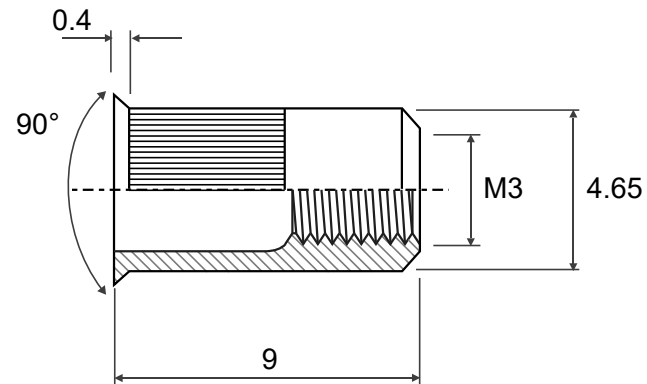

	Material		Customer Part No.	
	Finish		Web Ref No	